

4TECT

ООО «4TECT»

Телефон: +7 (499) 685-4444

info@4test.ru

www.4test.ru

PE PASTERNAK®
an INFINIT® brand

2021 RF Product Guide Full Catalog



Same-Day Shipping | Largest Selection | Expert Technical Support



With Over 45 Years of RF Expertise, It's More Than Parts That Sets Us Apart

Since 1972, Pasternack has been satisfying the urgent requirements of engineers around the world by offering the largest in-stock, ready-to-ship selection of RF, microwave, and mmWave components, assemblies and devices, including over 40,000 popular and hard-to-find items across 107 categories of interconnect, passives, actives, antennas, and test and measurement. Ranging from DC to 220 GHz maximum frequency levels, Pasternack components are used in a wide range of test, development and deployment environments for military/aerospace, telecom, commercial, and industrial applications.

- 99.4% in-stock availability
- Same-day shipping
- No minimum order quantity
- 24/7 assistance by phone, email or chat
- Engineers on-hand to answer questions
- International distribution partner network

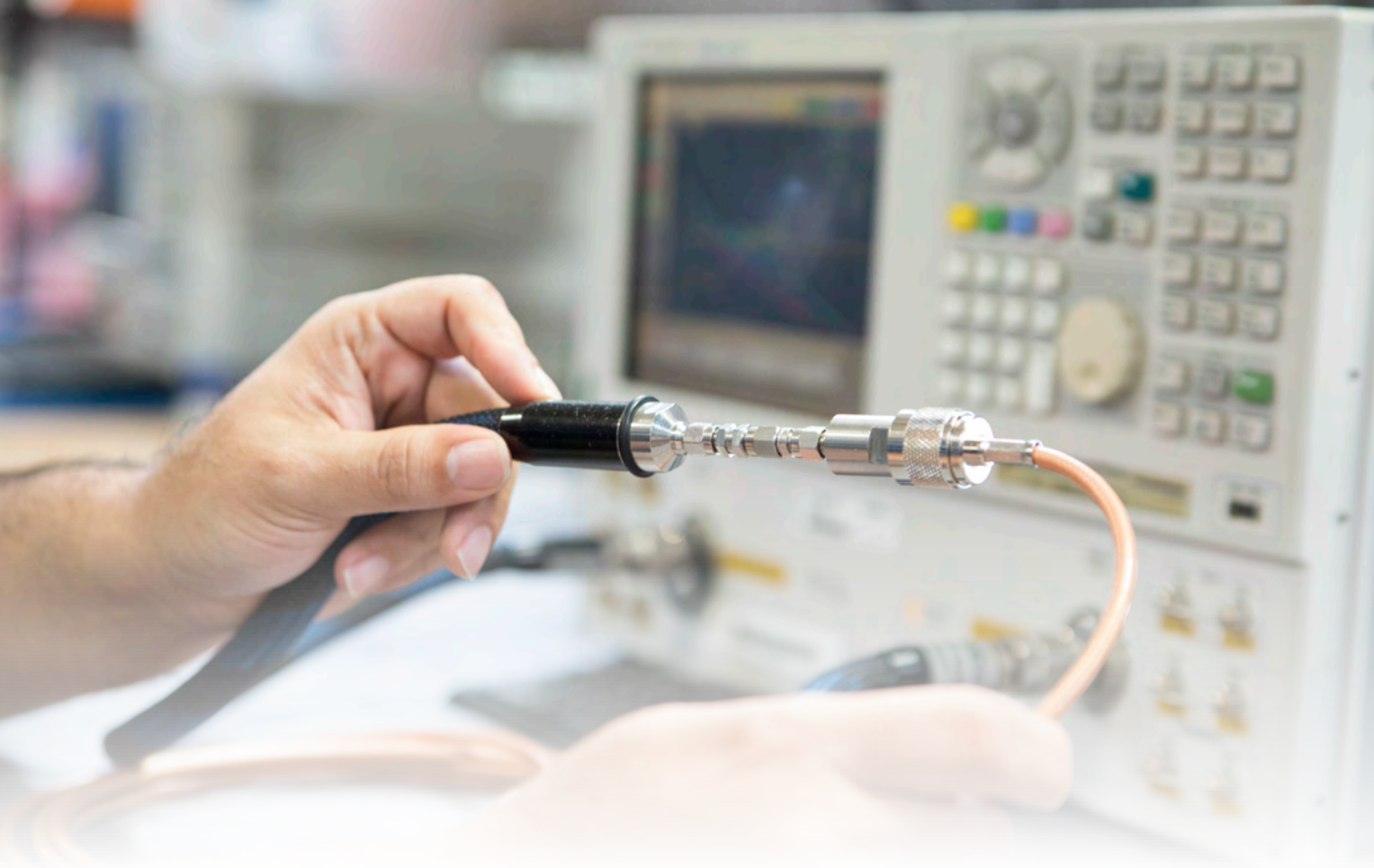

Largest RF Selection Available for Same-Day Shipping

- Adapters
- Amplifiers
- Antennas
- Attenuators/Equalizers
- Baluns
- Bias Tees/DC Blocks
- Cable Assemblies
- Cables
- Connectors
- Connector Accessories
- Couplers
- Educational Products
- Filters
- Frequency Multipliers/Dividers
- Impedance Matching
- Isolators/Circulators
- Limiters/Detectors
- Mixers/Modulators
- Noise Sources
- Oscillators/Synthesizers
- Phase Shifters/Trimmers
- Power Dividers/Combiners
- Rotary Joints
- Surge Protectors
- Switches
- Terminations
- Test and Measurement
- Tools
- Waveguides
- 60 GHz Systems & Modules



Expanded Portfolio of High Frequency Components

In Stock and Available for Same-Day Shipping!

Pasternack's RF Engineering team has curated a broad portfolio of microwave and millimeter wave components to address the needs of 5G innovation and testing, along with other applications requiring higher frequencies and greater bandwidth. Whether your high frequency requirements are for active, passive, or interconnect products, Pasternack has you covered with the industry's largest in-stock selection available for same-day shipping.

Waveguide Components to 220 GHz



Electromechanical Switches to 50 GHz

Waveguide Electromechanical Switches to 40 GHz



Test Cables and Adapters 2.92mm/40 GHz, 2.4mm/50 GHz 1.85mm/70 GHz, 1.0mm/110 GHz



Broadband Amplifiers to 86.5 GHz



Mixers and Detectors to 110 GHz



PIN Diode Switches to 67 GHz



High Frequency Power Dividers/ Couplers to 67 GHz



Calibrated Noise Sources to 60 GHz



High Band 5G 28 GHz and 39 GHz



RF PRODUCT GUIDE INDEX

High-Performance Hybrid Couplers; Bi-Phase Modulators; Positive Slope Equalizers; Fixed Load VNA Calibration Kits; Vehicular Antennas, GPS Timing Antennas and Portable UHF Antenna; Waveguide Shorts and Shims; Double Ridge Waveguide Electromechanical Relay Switches; High-Performance Waveguide Antennas; etc.	3	NEW PRODUCT ADDITIONS
60 GHz Development System; 60 GHz Receiver and Transmitter Modules; Radar Development Kit; WR-15 Gain Horn Antennas; 60 GHz Accessories	5	EDUCATIONAL PRODUCTS
Adapter Selection Guide; Adapter Locator (Part Number Identifier); Low PIM Adapters, Adapters to all Connectors	7	ADAPTERS
Amplifiers Selection Guide; Bi-Directional Amplifiers; Broadband Amplifiers; DC Coupled Amplifiers; Gain Block Amplifiers; Limiting Amplifiers; Linear Amplifiers; Log Amplifiers; Low Noise Amplifiers; Power-GaN Amplifiers; Rackmount Variable Gain Amplifiers; Amplifiers Accessories	46	AMPLIFIERS
Directional Antennas; Omni Directional Antennas; Antenna Mounts	57	ANTENNAS
Attenuators Selection Guide; Continuously Variable Attenuators; DC Bias Attenuators; Fixed Attenuators; Step Attenuators; TTL, CMOS, Relay and USB Attenuators; Voltage Variable Attenuators; Positive Slope Equalizers	64	ATTENUATORS & EQUALIZERS
Baluns	83	BALUNS
Bias Tees; DC Blocks	83	BIAS TEES & DC BLOCKS
Cable Assemblies Selection Guide; Cable Assemblies Locator (By Connector Type); High Reliability and Low PIM Cable Assemblies, Precision and Standard Cable Assemblies	85	CABLE ASSEMBLIES
Circulators; Isolators	190	CIRCULATORS & ISOLATORS
75 Ohm Broadcast; Communications; High Performance; RG MIL-C-17 Type Cables; Semi-Rigid & Formable; Twinax	193	COAX CABLES
Connector Selection Guide; Connector Locator (By Connector Type); All Connectors; Non-Shorting Caps; Shorting Caps	199	CONNECTORS
Dual Directional Couplers; Single Directional Couplers; 90 Degree and 180 Degrees Hybrids	268	COUPLERS & HYBRIDS
RF Diplexers	273	RF DIPLEXERS
Bandpass Filters; Highpass Filters; Lowpass Filters; Band Pass Filters; Band Reject Filters; Harmonic Filters	274	FILTERS
Mixers and Bi-Phase Modulators; Frequency Dividers; Frequency Multipliers	276	FREQ. CONVERSION COMPONENTS
Hi-REL Limiters; PIN-PIN Limiters; PIN-Schottky Limiters; Biased Detectors, Finline Detectors, Log Detectors; Phase Detectors, Power Detectors; Schottky Zero Bias Detectors; Threshold Detectors; Tunnel Diode Zero Bias Detectors	279	LIMITERS & DETECTORS
Precision and Standard Noise Sources	282	NOISE SOURCES
Adjustable Phase Shifters and Trimmers; 8 Bit Programmable Phase Shifters; Analog Phase Shifters	283	PHASE SHIFTERS/ TRIMMERS
Resistive and Reactive Power Dividers; Wilkinson Power Dividers; Broadband	283	POWER DIVIDERS & RF COMBINERS
Rotary Joints	286	ROTARY JOINTS
In-Line Surge Protectors; Replacement Cartridges	287	SURGE PROTECTORS
Electromechanical Relay Switches; SMT Packaged Electromechanical Relay Switches; Manual Switches; High Isolation USB Switches; High Isolation Switches; PIN Diode Switches GaN High Power Switches	288	SWITCHES
Synthesizers; Commercial Surface Mount Packaged VCO; Hermetically Sealed MIL Grade Surface Mount Packaged VCO; Connectorized Packaged VCO, Reference Oscillators, TCXO Oscillators, Phase Locked Oscillators and Phase Locked Crystal Oscillators	300	SYNTHESIZERS & OSCILLATORS
Equal Split; Unequal Split	305	TAPPERS
RF Load Terminations; Feed-Thru Load Terminations; Resistive Impedance Transformers	306	TERMINATIONS & MATCHING PADS
1.0mm Flexible VNA Test Cables; 26.5, 40, 50, 67 GHz and 75 Ohm Test Cables; Calibration Kits; Handheld RF Analyzer Rugged Stable Cable Assemblies; PE-TC151 and PE-TC195 Series Phase Stable Test Cable Assemblies; Semi-Rigid Pigtail Test Probes; VNA Test Cable Assemblies, etc.	312	TEST & MEASUREMENT PRODUCTS
Cable Cutters; Crimp Tools; Crimp Tool Dies ; Insertion/Extraction Tools; Torque Wrenches	319	TOOLS
WG Antennas; WG Bandpass Filters; WG Bends; WG Bulkhead Adapters; WG Converters; WG Couplers; WG Detectors; WG Direct Read Atten.; WG EMS; Flexible WG; WG Gunn Oscillators; WG Magic Tees; WG Phase Shifters; WG PIN Diode Switches; WG Power Amps., etc.	322	WAVEGUIDES
Pasternack REACH and RoHS Compliance Programs; Mailing List Changes; Binding Terms/Warranty; Part Number Index; Mounting Holes; Connector Identifiers; Connector Frequency Range Chart; Conversion Tables	350	APPENDIX

The information contained in this catalog and on pasternack.com is accurate to the best of our knowledge at the time of publication. It may be necessary to make modifications to the parts and/or the documentation of the parts, in order to implement improvements. Pasternack reserves

TABLE OF CONTENTS

Educational Products			
60 GHz Development System	5		
60 GHz Modules	5		
Radar Development Kit	6		
Waveguide Accessories	6		
Waveguide Gain Horns	6		
Adapters			
Adapters to All Connectors	16		
Locator (Part Number Identifier)	8		
Low PIM Adapters	14		
Quick Reference Guide	7		
Selection Guide	7		
Amplifiers			
Locator	46		
Quick Reference Guide	46		
Selection Guide	46		
Amplifier Accessories	56		
Bi Directional Amplifiers	48		
Broadband Amplifiers	48		
DC Coupled Amplifiers	50		
Gain Block Amplifiers	50		
GaN High Power Amplifiers	55		
Input Protected Low Noise Amplifiers	52		
Limiting Amplifiers	50		
Log Amplifiers	51		
Low Noise Amplifiers	51		
Power Amplifiers	53		
Variable Gain Amplifiers	56		
Antennas			
Antenna Mounts	63		
Directional Antennas	57		
Omni Directional Antennas	59		
Attenuators, Active			
Locator	64		
Quick Reference Guide	64		
Selection Guide	64		
Programmable Attenuators	81		
Voltage Variable Attenuators	82		
Attenuators, Passive			
Locator	64		
Quick Reference Guide	64		
Selection Guide	64		
Continuously Variable Attenuators	81		
DC Bias Attenuators	81		
Fixed Attenuators	66		
Step Attenuators, Push Button	79		
Step Attenuators, Rotary	80		
Step Attenuators, Toggle	80		
Baluns			
Surface Mount	83		
Bias Tee			
Bias Tee	83		
Cable Assemblies			
Locator (By connector Type)	86		
Low PIM and High-Reliability Cable Assemblies	90		
Precision and Standard Cable Assemblies	94		
Quick Reference Guide	85		
Selection Guide	85		
Circulators			
2.92mm Connectors	190		
N Connectors	190		
SMA Connectors	190		
Coaxial Cables			
75 Ohm Broadcast	194		
Communications	194		
High Performance	195		
RG Mil-C-17 Type Cable	196		
Semirigid and Formable	197		
Twinax Cable	198		
Connectors			
Locator (Part Number Identifier)	199		
Quick Reference Guide	199		
Selection Guide	199		
Connector Caps			
Non-Shorting Caps	267		
Shorting Caps	267		
Couplers			
90 degree Hybrid	272		
180 degree Hybrid	273		
Directional	268		
Dual Directional	271		
DC Blocks			
1.85mm	84		
2.4mm	84		
2.92mm	84		
BNC	84		
N	84		
SMA	84		
TNC	84		
BNC	84		
F	84		
N	84		
Detectors			
Biased Detectors	280		
Finline Detectors	280		
Log Detectors	280		
Phase Detectors	280		
Power Detectors	281		
Schottky Zero Bias Detectors	281		
Threshold Detectors	281		
Tunnel Diode Zero Bias Detectors	281		
RF Diplexers			
Low Pass and High Pass	273		
Equalizers			
Positive Slope Equalizers	82		
Filters			
Band Pass	276		
Band Reject	276		
Chebyshev Filters	275		
Combine Filters	274		
Filters	274		
High Pass Filters	275		
Low Pass Filters	275		
Frequency Dividers			
SMA Connectors	276		
Frequency Multipliers			
Active	278		
Passive	278		
Isolators			
2.4mm Connectors	191		
2.92mm Connectors	191		
N Connectors	191		
SMA Connectors	191		
Limiters			
HIGH REL	279		
PIN-PIN	279		
PIN-Schottky	279		
Manual Switches			
Manual Switches	295		
Matching Pads			
Resistive Impedance Transformers	311		
Mixers			
Double Balanced	277		
IQ	277		
Triple Balanced	277		
Modulators			
BiPhase	278		
Noise Sources			
Precision	282		
Standard	282		
Oscillators			
0.175" Ultra Small Commercial Surface Mount Packaged VCO	301		
0.5" Commercial Surface Mount Packaged VCO	301		
0.5" Commercial Surface Mount Packaged VCO w/ Integrated Buffer Amps	302		
0.5" Commercial Surface Mount Packaged VCO w/ Low Noise	302		
0.5" Commercial Surface Mount Packaged VCO w/ Modulation Input Port	302		
0.5" Hermetically Sealed MIL Grade Surface Mount Packaged VCO	302		
Connectorized Packaged VCO w/ Field Replaceable Connectors	303		
Phase Locked Crystal Oscillators	304		
Phase Locked Oscillators	304		
Reference Oscillators	303		
TCXO Reference Oscillators	304		
Phase Shifters			
8 Bit Programmable Phase Shifter	283		
Adjustable Phase Shifter	283		
Analog Phase Shifter	283		
Phase Trimmers			
Adjustable Phase Trimmer	283		
Power Dividers			
Reactive	284		
Resistive	284		
Wilkinson	285		
RF Combiners			
Broadband	286		
Rotary Joints			
2.92mm	286		
SMA-PCB	286		
Surge Protectors			
In-Line Surge Protectors	287		
Surge Protector Replacement Cartridges	287		
Switches			
Electromechanical Relay Switches	288		
Electromechanical Relay Switches, SMT Packaged	294		
GaN High Power Switches	299		
High Isolation PIN Diode Switches	299		
High Isolation USB PIN Diode Switches	299		
PIN Diode Switches	295		
Synthesizers			
Integer/Fractional	300		
Tappers			
Equal Split	305		
Unequal Split	305		
Terminations			
Feed-Thru Load	310		
RF Load	307		
Test And Measurement			
1.0mm Flexible VNA 110 GHz Precision Cables	316		
26.5 GHz and 40 GHz Test Cables	318		
40 GHz Skew Matched Cable Pairs	314		
41 GHz Skew Matched Cable Pairs	314		
42 GHz Skew Matched Cable Pairs	314		
4-in-1 Calibration Kits	313		
50 GHz and 67 GHz Test Cable Assemblies	315		
75 Ohm Test Cable Assemblies	318		
76 Ohm Test Cable Assemblies	318		
Bench Type Calibration Kits	312		
Handheld RF Analyzer Rugged Phase Stable Cable Assemblies	314		
Interchangeable Connectors	313		
PE-TC151 Series Phase Stable Test Cable	317		
PE-TC195 Series Phase Stable Test Cable	317		
RF Microwave Probes	313		
Semi-Rigid Pigtail Test Probes	318		
VNA Ruggedized Test Cable	315		
Tools			
Cable Cutter	319		
Crimp Tool Dies	321		
Crimp Tools	321		
Insertion/Extraction Tool	319		
Torque Wrenches	320		
Waveguides			
Double Ridge Waveguide Electromechanical Relay Switches	341		
Flexible Waveguides	341		
Waveguide Accessories	348		
Waveguide Antennas	324		
Waveguide Antennas Accessories	329		
Waveguide BandPass Filters	332		
Waveguide Bends	332		
Waveguide Bulkhead Adapters	333		
Waveguide Converter Mixers	333		
Waveguide Couplers	334		
Waveguide Couplers Assemblies	336		
Waveguide Detectors	339		
Waveguide Direct Read Attenuators	340		
Waveguide Electromechanical Relay Switches	340		
Waveguide Isolators	342		
Waveguide Low Noise Amplifiers	343		
Waveguide Magic Tees	343		
Waveguide Orthomode Transducers	343		
Waveguide Phase Shifters	343		
Waveguide PIN Diode Switches	344		
Waveguide Polarizers	344		
Waveguide Power Amplifiers	344		
Waveguide Sections	345		
Waveguide Terminations	346		
Waveguide Transitions	347		
Waveguide Twists	348		
Waveguide Variable Attenuators	348		

HELPFUL RESOURCES

Connector Freq. Range Chart	374	Mounting Hole Layout	369
Connector Identifier	370	Part Number Index	355
Conversion Tables	367	REACH-RoHS Compliance Program	351
How to Place your Order	352	Terms & Conditions	352

NEW PRODUCT ADDITIONS

High-Performance Hybrid Couplers (See pages [272](#), [273](#))



- High operating frequency range up to 40GHz for wide band applications
- Coaxial designs with SMA and 2.92mm connectors
- Output phase shifts of 90 degree and 180 degree available
- Power handling capability up to 100W(CW)
- Very good isolation and insertion loss performances with low return loss
- Flat phase balance performance across frequency range

Bi-Phase Modulators Operating in Frequency Bands from 0.5 to 40 GHz (See pages [278](#))



- Broadband frequency coverage from 500 MHz to 40 GHz
- Comprehensive selection of 9 models offered
- TTL level digital bit stream is encoded onto the RF carrier
- 2 Phase Shift Keying (2PSK) modulation at 180° and 0°
- Low insertion loss: 2.5 dB typical
- Compact packaging with SMA or 2.92mm RF female connectors
- High peak input power handling up to 0.5 watts

Positive Slope Equalizers (See pages [82-83](#))



- Broadband frequency coverage from 500 MHz to 40 GHz
- Comprehensive selection of 18 models offered
- Fixed positive slope equalizing values ranging from 2 dB to 8 dB
- Low insertion loss ranging from 1 dB to 3 dB
- Compact packaging with field replaceable RF connectors
- High CW input power handling up to +30 dBm

Fixed Load VNA Calibration Kits (See pages [312](#))



- Include all necessary components to perform highly accurate 1 port to 4 port calibration of VNAs
- Offer components for short open load calibration technique -or- short open load and thru method
- 7 connector series including:
 - 2.4mm, 50 GHz SOL, SOLT;
 - 2.92mm, 40 GHz, SOL, SOLT;
 - 3.5mm, 26.5 GHz, SOL, SOLT;
 - 7/16 DIN, 7.5 GHz, SOL, SOLT;
 - 7mm, 18 GHz, SOLT;
 - BNC, 10 GHz, SOLT;
 - N-Type, 18 GHz, SOL, SOLT

Vehicular Antennas, GPS Timing Antennas and Portable UHF Antenna (See pages [60](#), [62](#), [63](#))



- Broad selection of vehicular antennas and antenna kits
- 108 MHz – 2.7 GHz operating frequencies, 0-32 dBi
- Ideally suited for multi-point mobile applications, including service vehicles, public transportation, public safety, mining, construction, and other mobile, wide-coverage applications

Waveguide Shorts and Shims in WR-430 to WR-10 Waveguide Sizes (See pages [348-349](#))



- Frequency ranges from 1.72 GHz to 110 GHz in 18 waveguide bands
- Waveguide sizes from WR-10 to WR-430
- Parts made with high-precision machining in aluminum or brass
- Large product selection available

Double Ridge Waveguide Electromechanical Relay Switches (See pages [341](#))



- Comprehensive selection of 12 double ridge WG EMS models
- Broadband multi-octave frequency: 6.5 GHz to 40 GHz
- SPDT and optional DPDT configurations with latching self cut-off actuators, TTL logic, and position indicators with manual override
- Power handling capability up to 8.5 kW CW
- Designs support WRD-650, WRD-750, and WRD-180 waveguide sizes
- Patented motor drive with arc suppression
- Environmentally sealed quick connect DC control connector & mate included

High-Performance Waveguide Antennas (See pages [327-328](#), [331-332](#))



- Complete line of high-performance waveguide antennas, with operating frequencies from 1.7 to 220 GHz
- Ideal for applications such as: Antenna Measurements, Laboratory Use, Wireless Communications, Microwave Radio Systems

NEW PRODUCT ADDITIONS

High Frequency Waveguide Components for Transmission Lines (See pages [332-333](#), [345-346](#), [348](#))



- High frequency ranges from 90 GHz to 220 GHz in 3 waveguide bands
- Waveguide sizes: WR-8, WR-6 and WR-5
- UG-387/U mod round cover style flange
- Large product selection available

New Class AB High Power Amplifiers with Optional Heatsinks (See pages [53](#), [56](#))



- 18 new class AB broadband power amplifiers support popular octave bands ranging from 20 MHz to 18 GHz
- GaN, LDMOS, and VDMOS designs feature high linearity and efficiency with low distortion over a wide dynamic range
- Saturated output power levels ranging from 10 watts to 200 watts with up to 40% power added efficiency
- Power gain levels range from 37 dB to 53 dB
- D-Sub control connectors for DC bias, enable with TTL logic control, current and temperature sense functions
- Compact and rugged coaxial packages have optional heatsink with cooling fans available

Coaxial RF Surge Protectors with 4.3-10 Connectors (See pages [287](#))



- 4.3-10 F/M Bulkhead Coaxial RF Surge Protector
- Frequency Range: 698MHz - 2.7GHz
- Low PIM -173 dBc

High Power Attenuators with Frequency Coverage of 6 GHz and 18 GHz (See pages [72](#), [75](#))



- Support frequency range from DC up to 18 GHz
- Power handling capability up to 100W(CW)
- Coaxial designs with SMA and N-type connectors
- Flat RF response and performance
- VSWR as low as 1.2:1
- Available with 3 dB to 40 dB attenuation levels

Frequency Dividers in Rugged and Compact SMA Connectorized Packages (See pages [276](#))



- Comprehensive selection of 28 different prescaler models
- Broadband input frequency coverage from 0.1 GHz to 20 GHz
- Broad selection of divide-by-ratios ranging from 2 to 40
- Input power range from -20 dBm to +15 dBm
- Output power levels range from -6 to +5 dBm
- Low phase noise down to -155 dBc/Hz typical @ 100 kHz offset
- Compact coaxial packaged assemblies guaranteed to meet MIL-STD environmental test conditions

High Frequency Couplers with Low Insertion Loss and Low Return Loss (See pages [268](#), [270](#))



- Directional couplers with high operating frequency range up to 67 GHz for wide band applications
- Coaxial designs with SMA, 2.92mm, 2.4mm and 1.85mm connectors
- Power handling capability up to 30W(CW)
- Excellent isolation and insertion loss performances with low return loss
- Available with 6dB, 10dB, 15dB, 20dB and 30dB coupling levels

RF Limiters with Frequencies up to 40 GHz (See pages [279](#))



- Broadband Frequency Coverage from 20 MHz to 40 GHz
- 13 Different Models Offer Comprehensive Performance Features
- CW Input Power Rated up to 5 watts
- Peak Power Handling Capability of 200 Watts
- Flat Leakage Power Ranges from +10 dBm to +18 dBm
- Compact Packages with Field Replaceable Connectors and Thru Mounting Holes
- Models are Designed to Meet MIL-STD-202 Test Conditions

Aluminum Waveguide-to-Coax Adapters, MIL-DTL-22641 compliant (See pages [329-331](#))



- Aluminum body for reduced weight
- Electrical performance and mechanical dimensions compliant with MIL-DTL-22641
- 14 different waveguide sizes available from WR-42 to WR-430 (Frequency range from 1.7 to 26.5GHz)
- VSWR as low as 1.25:1
- Flange types: UG square/round cover, CMR or CPR
- Available in SMA female, N-type female and 2.92mm female connectorized designs, as well as end launch connector configurations

EDUCATION PRODUCTS

60 GHz Development System



The Pasternack 60 GHz development system provides rapid evaluation of Pasternack's 60 GHz waveguide modules for quick prototyping for millimeter wave wireless system development. This high speed wireless 60 GHz developer kit is created in a partnership between Pasternack and Vubiq (pronounced "View-bik"), an industry expert in designing 60 GHz RF systems. Our 60 GHz wireless development system makes it easy and fast to design new products and applications in the emerging unlicensed millimeter wave ISM V band.

This 60 GHz wireless communications development system facilitates an accelerated design of new high bandwidth products and solutions. This Pasternack 60 GHz development kit utilizes a convenient to use GUI for configuration via USB. A standard WR-15 V-band waveguide antenna interface is incorporated into this millimeter wave system and has a 1.8 GHz modulation bandwidth. 802.11ad and 802.11aj WiFi / WiGig development is supported by the 60 GHz wireless communication system.

60 GHz Development System and Waveguide Modules is a versatile toolkit that allows imagining and designing applications in the readily accessible ISM band. The below list illustrates possible usages of the system and modules:

- High bandwidth data links, supporting multi-gigabit data rates such as gigabit Ethernet data communication
- Wi-Fi, 802.11ad and 802.11aj
- High speed video and audio solutions
- High bandwidth modulation techniques using Quadrature Amplitude Modulation (QAM) and Multiple Input Multiple Output (MIMO)
- High-Definition Serial Digital Interface (HD-SDI) video links
- High resolution radar using Frequency Modulated Continuous Wave (FMCW) modulation
- Building-to-building high speed networks
- High resolution synthetic aperture radar (also using FMCW modulation)
- Remote sensing
- Atmospheric radiometers (receive only) for oxygen and atmospheric research
- Liquid level detection
- Military applications



60 GHz Modules



The 60 GHz transmitter and 60 GHz receiver modules open up ultra high speed, high bandwidth data transmission for widespread use. Pasternack 60 GHz waveguide modules utilizes the globally unlicensed millimeter wave spectrum of 57 GHz to 64 GHz. Our wireless 60 GHz waveguide transmitter and receiver components are ideal for meeting the high speed data transmission needs of companies and developers.

These silicon germanium (SiGe) chip based 60 GHz transceiver modules are lower cost and easier to integrate than existing competing products. Pasternack's 60 GHz V band wireless solution is equally effective at a fraction of the cost and can be connected to any off-the-shelf WR-15 waveguide through the UG-385/U flange. Lower cost, ease of use and ability to attach standard components make these 60 GHz Tx and Rx units practical for a wide range of configurations and budgets.

For typical 60 GHz waveguide module applications please refer to the 60 GHz-Development Section above.

Type	Frequency Range (GHz)	Mod. Bw. (GHz)	Gain (dB)	Gain Range (dB)	Input Range P1dB (dBm)	Psat (dBm)	NF (dB)	Input IP3 (dBm)	ECCN	Model No	1 Pc. Price	See Web for Volume Pricing	ROW
Development System	57.0 - 64.8	1.10	both	both	both	15	6	-27	3A001.B.4.F.1	PEM009-KIT	\$13,252.17	See Web for Volume Pricing	1
Transmitter	57.0 - 64.8	1.8	38	20	12	15			3A001.B.4.F.1	PEM010	Call		2
Receiver	57.0 - 64.8	1.8	67	65	-36		6	-27	3A001.B.4.F.1	PEM002-MIM	Call		3
Transmitter Dev. System	57.0 - 64.8	1.1	38	20	12	15			3A001.B.4.F.1	PEM009-KIT-TX	\$8,352.79		4

Gain Horn Antennas

Pasternack's high gain WR-15 horn antennas operate between 50 GHz and 70 GHz and are available in 20 dBi, 24 dBi, 34 dBi and 42 dBi gain models. Pasternack's WR-15 waveguide horn antennas pair seamlessly with the recently added 60 GHz transmit/receive development system (PEM003-KIT) which enables companies to experiment and develop applications in the globally-unlicensed 60 GHz frequency band. Using two of Pasternack's WR-15 beam antennas rated to 42 dBi gain (PE9881-42), a user is able to transmit and receive a 60 GHz signal at a distance of one kilometer (km), making these antennas an ideal solution for high frequency point-to-point backhaul.

Additionally, Pasternack offers an omni-directional millimeter wave antenna (PE-W15A001), a vertically polarized WR-15 waveguide connected antenna using a standard UG387/U flange that operates between 58 GHz and 63 GHz. This omni-directional millimeter wave antenna has a 30 degree vertical beam width and a 360 degree horizontal gain variation, making it ideal for short range wireless communications, indoor networks, high frequency applications and 60 GHz development systems. The millimeter wave omni-directional antenna is constructed with a durable brass waveguide input and light-weight aluminum body.



Freq. Range (MHz.)	Waveguide Size	Interface Type	Gain	ECCN	Model No	1	2-4	5-9	10+	ROW
50 - 75	WR-15	UG-385/U	20	5A991	PE9881-20	Call	Call	Call	Call	5
			24	5A991	PE9881-24	\$1,479.18	\$1,420.01	\$1,360.85	\$1,301.68	6
			42	5A991	PE9881-42	\$2,366.43	\$2,271.77	\$2,177.12	\$2,082.46	7
56 - 66	WR-15	UG-385/U	34	5A991	PE9881-34	\$1,552.93	\$1,498.58	\$1,444.22	\$1,397.64	8
58 - 63	WR-15	UG-387/U	0	5A991	PE-W15A001	Call	Call	Call	Call	9

60 GHz Accessories



Model No	Description	1 Pc. Price	ROW
PEM004	60GHz Baseboard I/Q Module	\$2,191.51	10
PEM005	60 GHz Waveguide Module Flex Circuit Cable	\$651.62	11

Radar Development Kits



Model No	Description	1	2-4	5-9	10+	ROW
PEM11002-KIT	2.4 GHz to 2.5 GHz ISM Band Radar Demonstration Kit, USB or Bluetooth Control, GUI, Includes Radar Board, Antennas, Cables, and Accessories	\$2,829.26	\$2,716.09	\$2,602.92	\$2,489.75	12
PEM11000-KIT	2.4 GHz to 2.5 GHz ISM Band Radar Demonstration Kit, USB or Bluetooth Control, GUI, Includes Radar Board, Antennas and Cables	\$2,598.30	\$2,494.37	\$2,390.44	\$2,286.50	13

See Our Website For Current Pricing & Real-Time Stock Availability!

Adapter Selection Guide

3 Easy Ways to Find your Product.....

1. Search by PE Part Number

If you know the PE part number you are searching for, please reference our Part Number Index on Page [355](#)

2. Quick Reference Guide

(Page number refers to first appearance of product in the Adapter Section)

Connector Series	Page	Connector Series	Page	Connector Series	Page	Connector Series	Page	Connector Series	Page
1.0/2.3	33	10-32	22	Banana	45	MHV	23	SC	21
1.0mm	16	75 Ohm BNC	42	BMA	22	Mini SMP	17	SHV	26
1.85mm	16	75 Ohm F	23	BNC	19	Mini UHF	26	SMA	17
2.4mm	16	75 Ohm Mini SMB	43	BNC Triax	23	MMBX	27	SMB	29
2.4mm NMD	17	75 Ohm N	43	C	23	MMCX	26	SMC	29
2.92mm	16	75 Ohm PAL	43	Double Banana Binding Post	23	N	16	SMP	17
2.92mm NMD	42	75 Ohm RCA	23	D-Sub	24	QMA	29	SSMA	18
3.5mm	16	75 Ohm SMB	23	FME	24	Rev Pol BNC	23	SSMB	35
3.5mm NMD	19	75 Ohm SMC	23	GR874	24	Rev Pol MCX	37	SSMC	37
4.1/9.5 Mini DIN	19	75 Ohm TNC	44	HN	21	Rev Pol N	28	TNC	29
4.3-10	14	78 Ohm BNC	45	LC	25	Rev Pol SMA	32	UHF	29
7/16 DIN	20	Twinax		MCX	25	Rev Pol TNC	30	UMCX	35
7mm	17	95 Ohm 3/4"-20 Twinax	45			Rev Thread SMA	33		

Adapter Locator Layout

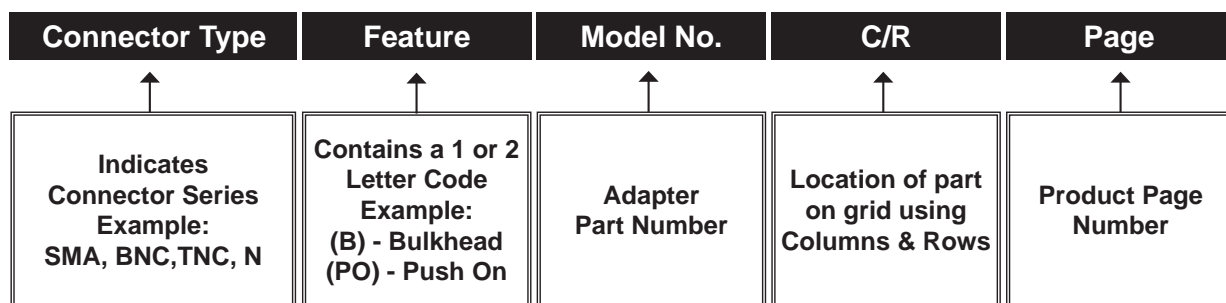

3. Between-Series Adapter Locator

(Adapter Locator starts on Page [8](#))



SMA FEMALE TO TNC FEMALE
PE9079

SMA Female To:		EXAMPLE		
Connector Type	Feature	Model No.	C/R	Page
SSMA Male		PE9188	A4	163
SSMB Plug		PE9402	A3	167
TNC Female		PE9079	D6	164
TNC Female	(B)	PE9251	A1	165

TNC Female To:		EXAMPLE		
Connector Type	Feature	Model No.	C/R	Page
SMA Female	(P)	PE9442	C6	164
SMA Female		PE9079	D6	164
SMA Female	(B)	PE9251	A1	165
SMA Female	(PM)	PE9276	B1	165

The Adapter Locator example above includes Between-Series part numbers in two configurations:

Connector 1 to Connector 2 as well as Connector 2 to Connector 1 can be found in the same location.

Products can only be found under the first instance of the series combination. As an example, PE9079 above will be found in only one location in the Adapter Section.

Adapter Locator

Connector Type	Feature	Model No.	C/R	Page
1.0/2.3 Jack To:				
SMA Female		PE9693	A4	35
SMA Male		PE9690	D4	33
1.0/2.3 Plug To:				
SMA Female		PE9691	E3	35
SMA Male		PE9692	C4	33
1.0mm Female To:				
1.85mm Female		PE91109	D2	16
1.85mm Male		PE91119	C2	16
1.0mm In-Series:				
Female to Female		PE91463	D1	16
Female to Male		PE91461	C1	16
Male to Male		PE91462	B1	16
1.0mm Male To:				
1.85mm Female		PE91108	B2	16
1.85mm Male		PE91118	A2	16
1.85mm Female To:				
1.0mm Female		PE91109	D2	16
1.0mm Male		PE91108	B2	16
2.4mm Female	90°	PE91159	B5	16
2.4mm Male		PE9675	C2	17
2.4mm Female		PE9674	D7	16
2.92mm Female		PE9668	D2	18
2.92mm Male	90°	PE91162	C5	16
2.92mm Male		PE9666	D6	17
3.5mm Female		PE9748	D2	19
3.5mm Male		PE9745	A1	19
N Female		PE9721	E5	16
N Male		PE9720	D5	16
SMA Female		PE9729	C4	35
SMA Male		PE9728	A5	33
1.85mm In-Series:				
Female to Female		PE91084	E3	16
Female to Female		PE91115	A4	16
Male to Female		PE91086	C3	16
Male to Female		PE9715	D3	16
Male to Male		PE91085	A3	16
Male to Male		PE9716	B3	16
1.85mm Male To:				
1.0mm Female		PE91119	C2	16
1.0mm Male		PE91118	A2	16
2.4mm Female		PE9673	B2	17
2.4mm Male		PE9672	C7	16
2.92mm Female		PE9665	C2	18
2.92mm Male	90°	PE91161	C4	16
2.92mm Male		PE9667	O6	17
3.5mm Female		PE9747	D4	16
3.5mm Male		PE9746	E7	18
N Female		PE9719	A5	16
N Male		PE9718	E4	16
SMA Female		PE9726	B4	35
SMA Male		PE9727	E4	33
10-32 Female To:				
BNC Female		PE9752	A6	22
BNC Female	(B)	PE9754	B6	22
BNC Male		PE9750	E5	22
10-32 In-Series:				
Female to Female		PE9756	D4	22
Female to Female	(B)	PE9757	E4	22
10-32 Male To:				
BNC Female		PE9753	C5	22
BNC Female	(B)	PE9755	D5	22
BNC Male		PE9751	B5	22
2.4mm Female To:				
1.85mm Female		PE9675	C2	17
1.85mm Female	90°	PE91159	B5	16
1.85mm Male		PE9673	B2	17
2.4mm NMD Female		PE91145	A4	17
2.92mm Female		PE91295	B3	18
2.92mm Female		PE91499	C3	18
2.92mm Female		PE9456	D3	18
2.92mm Male		PE91450	B7	17
2.92mm Male		PE9455	C7	17
2.92mm Male	90°	PE91070	D7	17
2.92mm Male		PE91168	A1	18
3.5mm Female		PE9659	D3	19
3.5mm Female	90°	PE91165	E7	17
7mm Sexless		PE9460	B1	18
Mini SMP Female		PE91126	E1	18
Mini SMP Male		PE91124	C1	18
N Female	(P)	PE9662	B2	18
N Male	(P)	PE9661	A2	18
SMA Female	(P)	PE91009	A5	35
SMA Male	(P)	PE91010	D5	33
Smooth Bore Mini SMP Male		PE91125	D1	18
2.92mm NMD Female To:				
2.4mm Female		PE91144	B5	42
3.5mm Female To:				
1.85mm Female		PE9748	D2	19
1.85mm Male		PE9747	D4	16
2.4mm Female		PE91291	B3	19
2.4mm Female		PE9652	C3	19
2.4mm Male		PE91292	E2	19
2.4mm Male		PE9650	A3	19
2.92mm Female		PE9660	A4	18
2.92mm Female	90°	PE91167	B4	18
2.92mm Male		PE9659	D3	19
2.92mm Male	90°	PE91168	A1	18
7mm Sexless	(P)	PE9325	E3	19
N Female	(P)	PE9323	B4	19
N Male	(P)	PE9321	A4	19
SMA Female		PE9725	D5	35
3.5mm In-Series:				

Connector Type	Feature	Model No.	C/R	Page
2.92mm Female				
2.92mm Female		PE91451	E2	18
2.92mm Female		PE9454	A3	18
2.92mm Male	90°	PE91508	E7	16
2.92mm Male		PE91298	E6	17
2.92mm Male		PE9457	A7	17
3.5mm Female		PE91292	E2	19
3.5mm Female		PE9650	A3	19
3.5mm Male		PE91294	B1	19
3.5mm Male		PE9649	C1	19
7mm Sexless		PE9458	B1	17
Full Detent Mini SMP Male				
Mini SMP Female		PE91120	D1	17
N Female	(P)	PE9501	A2	17
N Male	(P)	PE9504	E1	17
SMA Female		PE9655	D4	35
SMA Male	(P)	PE9653	B5	33
2.4mm NMD Female To:				
2.4mm Female		PE91145	A4	17
SMA Female	(RU)	PE91146	B4	17
2.92mm Female To:				
1.85mm Female		PE9668	D2	18
1.85mm Male		PE9665	C2	18
2.4mm Female		PE91295	B3	18
2.4mm Female		PE91499	C3	18
2.4mm Female		PE9456	D3	18
2.4mm Male		PE91451	E2	18
2.4mm Male		PE9454	A3	18
2.4mm Male	90°	PE91502	A1	17
3.5mm Female		PE9660	A4	18
3.5mm Female	90°	PE91167	B4	18
3.5mm Male	90°	PE91166	E3	18
3.5mm Male		PE9658	E1	19
7mm Sexless		PE9461	C4	18
Full Detent Mini SMP Male				
Mini SMP Female		PE9782	B5	18
Mini SMP Male		PE9781	D4	18
N Female	(P)	PE9664	D5	18
N Male	(P)	PE9663	C5	18
SMA Female	(P)	PE91011	B5	35
SMA Male	(P)	PE91008	E5	33
Smooth Bore Mini SMP Male		PE91128	A5	18
SMP Female				
SSMA Male		PE91060	E5	18
SSMA Male		PE9768	A6	18
2.92mm Female To:				
2.92mm Male	(R)	PE91070	D7	17
2.92mm In-Series:				
Female to Female		PE91510	B5	17
Female to Female		PE9438	C5	17
Female to Female	(B)	PE9647	D5	17
Female to Female	(PM)	PE91113	E5	17
Female to Female	(PM)	PE9648	A6	17
Male to Female		PE9437	A5	17
Male to Male		PE9436	D4	17
Male to Male	90°	PE9645	E4	17
2.92mm Male To:				
1.85mm Female		PE9666	D6	17
1.85mm Female	90°	PE91162	C5	16
1.85mm Male		PE9667	C6	17
1.85mm Male	90°	PE91161	C4	16
2.4mm Female		PE91450	B7	17
2.4mm Female		PE9455	C7	17
2.4mm Male		PE91298	E6	17
2.4mm Male		PE9457	A7	17
2.4mm Male	90°	PE91508	E7	16
2.92mm Female	(R)	PE91070	D7	17
3.5mm Female	90°	PE91168	A1	18
3.5mm Female		PE9659	D3	19
3.5mm Male	90°	PE91165	E7	17
7mm Sexless		PE9460	B1	18
Mini SMP Female		PE91126	E1	18
Mini SMP Male		PE91124	C1	18
N Female	(P)	PE9662	B2	18
N Male	(P)	PE9661	A2	18
SMA Female	(P)	PE91009	A5	35
SMA Male	(P)	PE91010	D5	33
Smooth Bore Mini SMP Male		PE91125	D1	18
2.92mm NMD Female To:				
2.4mm Female		PE91144	B5	42
3.5mm Female To:				
1.85mm Female		PE9748	D2	19
1.85mm Male		PE9747	D4	16
2.4mm Female		PE91291	B3	19
2.4mm Female		PE9652	C3	19
2.4mm Male		PE91292	E2	19
2.4mm Male		PE9650	A3	19
2.92mm Female		PE9660	A4	18
2.92mm Female	90°	PE91167	B4	18
2.92mm Male		PE9659	D3	19
2.92mm Male	90°	PE91168	A1	18
7mm Sexless	(P)	PE9325	E3	19
N Female	(P)	PE9323	B4	19
N Male	(P)	PE9321	A4	19
SMA Female		PE9725	D5	35
3.5mm In-Series:				

Connector Type	Feature	Model No.	C/R	Page
Female to Female				
Female to Female		PE9331	A7	18
Female to Female	(B)	PE9678	B7	18
Female to Female	(PM)	PE9676	C7	18
Male to Female		PE9332	E6	18
Male to Male		PE9330	C6	18
Male to Male	90°	PE91169	D6	18
3.5mm Male To:				
1.85mm Female		PE9745	A1	19
1.85mm Male		PE9746	E7	18
2.4mm Female		PE9651	D1	19
2.4mm Male		PE91294	B1	19
2.4mm Male		PE9649	C1	19
2.92mm Female		PE9658	E1	19
2.92mm Female	90°	PE91166	E3	18
2.92mm Male	90°	PE91165	E7	17
7mm Sexless	(P)	PE9326	A2	19
N Female	(P)	PE9324	C2	19
N Male	(P)	PE9322	B2	19
SMA Female		PE9724	C5	35
SMA Male		PE9722	A6	33
3.5mm NMD Female To:				
2.4mm Female		PE91148	D4	19
SMA Female	(RU)	PE91147	E4	19
4.1/9.5 Mini DIN Female To:				
7/16 DIN Female		PE91208	A1	22
7/16 DIN Female		PE91245	B1	22
7/16 DIN Female	(LP)	PE91091	C1	22
7/16 DIN Female	(B)	PE91210	D1	22
7/16 DIN Female	(B)	PE91247	E1	22
7/16 DIN Male		PE91207	A5	21
7/16 DIN Male		PE91244	B5	21
7/16 DIN Male	(LP)	PE91089	C5	21
N Female		PE91218	B2	20
N Female		PE91255	C2	20
N Female	(LP)	PE91095	D2	20
N Female	(B)	PE91220	E2	20
N Female	(B)	PE91257	A3	20
N Male		PE91219	D1	20
N Male		PE91256	E1	20
N Male	(LP)	PE91094	A2	20
4.1/9.5 Mini DIN In-Series:				
Female to Female		PE91233	D6	19
Female to Female	(B)	PE91197	E6	19
Female to Female	(B)	PE91234	A7	19
Male to Female		PE91195	B6	19
Male to Female		PE91232	C6	19
Male to Male		PE91194	E5	19
Male to Male		PE91231	A6	19
4.1/9.5 Mini DIN Male To:				
7/16 DIN Female		PE91209	C7	21
7/16 DIN Female		PE91246	D7	21
7/16 DIN Female	(LP)	PE91090	E7	21
7/16 DIN Male		PE91206	C4	21
7/16 DIN Male		PE91243	D4	21
7/16 DIN Male	(LP)	PE91088	E4	21
N Female		PE91217	A1	20
N Female		PE91254	B1	20
N Female	(LP)	PE91093	C1	20
N Male		PE91216	C7	19
N Male		PE91253	D7	19
N Male	(LP)	PE91092	E7	19
4.3-10 Female To:				
7/16 DIN Female	(LP)	PE91471	D2	22
7/16 DIN Male	(LP)	PE91469	E5	21
7/16 DIN Male	(LP)	PE91390	A6	21
N Female	(LP)	PE91475	A7	20
N Male	(LP)	PE91479	D6	20
N Male	(LP)	PE91388	A4	28
4.3-10 In-Series:				
Female to Female	(LP)	PE91464	C4	20
Female to Female	(LP)	PE91386	D4	20
Male to Female	(LP)	PE91465	E3	20
Male to Female	(LP) 90°	PE91467	A4	20
Male to Female	(LP)	PE91387	B4	20
Male to Male	(LP)	PE91466	C3	20
Male to Male	(LP)	PE91385	D3	20
4.3-10 Male To:				
7/16 DIN Female	(LP)	PE91470	A2	22
7/16 DIN Female	(LP)	PE91391	C2	22
7/16 DIN Female	(LP)	PE91468	D5	21
N Female	(LP)	PE91474	C5	20
N Female	(LP)	PE91477	D5	20
N Female	(LP) 90°	PE91483	A6	20
N Female	(LP)	PE91389	B6	20
N Male	(LP)	PE91476	A5	20
SMA Female	(LP)	PE91484	C6	20
7/16 DIN Female To:				
4.1/9.5 Mini DIN Female		PE91208	A1	22
4.1/9.5 Mini DIN Female		PE91245	B1	22
4.1/9.5 Mini DIN Female	(LP)	PE91091	C1	22
4.1/9.5 Mini DIN Female	(B)	PE91210	D1	22
4.1/9.5 Mini DIN Female	(B)	PE91247	E1	22
4.1/9.5 Mini DIN Male		PE91209	C7	21
4.1/9.5 Mini DIN Male		PE91246	D7	21
4.1/9.5 Mini DIN Male	(LP)	PE91090	E7	21
4.3-10 Female	(LP)	PE91471	D2	22
4.3-10 Male	(LP)	PE91470	A2	22
4.3-10 Male				

Adapter Locator

Connector Type	Feature	Model No.	C/R	Page
HN Male		PE9559	A3	22
N Female		PE91213	D3	22
N Female		PE91250	E3	22
N Female	(B)	PE91215	A4	22
N Female	(B)	PE91252	B4	22
N Female	(LP)	PE91033	B5	29
N Female	(LP)	PE9180	C5	29
N Male		PE91214	B3	22
N Male		PE91251	C3	22
N Male	(LP)	PE91032	D4	28
N Male		PE91134	E4	28
QD 4.3-10 Female	(LP) (QD)	PE91473	E2	22
QD 4.3-10 Male	(LP) (QD)	PE91472	B2	22
SMA Female	(LP)	PE91042	D6	35
SMA Male	(LP)	PE91041	D6	33
SMA Male		PE9411	E6	33
TNC Female		PE91392	B6	41
TNC Male		PE9638	C3	41
7/16 DIN In-Series:				
Female to Female		PE91192	C2	21
Female to Female		PE91229	D2	21
Female to Female	(LP)	PE91029	E2	21
Female to Female		PE9409	A3	21
Female to Female		PE9556	B3	21
Female to Female	(B) (LP)	PE91038	C3	21
Female to Female	(B)	PE9414	D3	21
Female to Female	(B)	PE91193	E3	21
Female to Female	(B)	PE91230	A4	21
Female to Male		PE9557	B2	21
Male to Female		PE91191	B1	21
Male to Female		PE91228	C1	21
Male to Female		PE91027	D1	21
Male to Female	(LP)	PE91028	E1	21
Male to Female	90°	PE91117	A2	21
Male to Male		PE91190	D7	20
Male to Male		PE91227	E7	20
Male to Male	(LP)	PE91039	A1	21
7/16 DIN Male To:				
4.1/9.5 Mini DIN Female		PE91207	A5	21
4.1/9.5 Mini DIN Female		PE91244	B5	21
4.1/9.5 Mini DIN Female	(LP)	PE91089	C5	21
4.1/9.5 Mini DIN Male		PE91206	C4	21
4.1/9.5 Mini DIN Male		PE91243	D4	21
4.1/9.5 Mini DIN Male	(LP)	PE91088	E4	21
4.3-10 Female	(LP)	PE91469	E5	21
4.3-10 Female	(LP)	PE91390	A6	21
4.3-10 Male	(LP)	PE91468	D5	21
HN Female		PE9558	B6	21
N Female		PE91212	E6	21
N Female		PE91249	A7	21
N Female	(LP)	PE91031	A5	29
N Male		PE91211	C6	21
N Male		PE91248	D6	21
N Male	(LP)	PE91030	B4	28
N Male		PE9535	C4	28
SC Female		PE91444	B7	21
SMA Female	(LP)	PE91036	B6	35
SMA Female		PE91175	C6	35
SMA Male	(LP)	PE91043	C6	33
75 Ohm BNC Female To:				
75 Ohm F Female	(B)	PE91324	A7	42
75 Ohm F Female		PE9744	B3	43
75 Ohm F Male		PE9743	C2	43
75 Ohm Mini SMB Jack		PE9619	D5	43
75 Ohm Mini SMB Plug		PE9617	B5	43
75 Ohm N Female		PE9371	B3	44
75 Ohm N Male		PE9369	D7	43
75 Ohm TNC Male		PE9631	C3	45
75 Ohm BNC In-Series:				
Female to Female		PE9362	B6	42
Female to Female	(B)	PE9363	C6	42
Female to Female	(PM)	PE9367	D6	42
Female to Male		PE9365	A6	42
Male to Female	90°	PE9361	E5	42
Male to Male		PE9364	D5	42
75 Ohm BNC Male To:				
75 Ohm F Female		PE9741	A3	43
75 Ohm F Male		PE9742	B2	43
75 Ohm Mini SMB Jack		PE9618	C5	43
75 Ohm Mini SMB Plug		PE9616	A5	43
75 Ohm N Female		PE9368	A3	44
75 Ohm N Male		PE9370	C7	43
75 Ohm TNC Female		PE9630	A4	45
75 Ohm F Female To:				
75 Ohm BNC Female	(B)	PE91324	A7	42
75 Ohm BNC Male		PE9741	A3	43
75 Ohm N Female		PE9740	E3	44
75 Ohm N Male		PE9396	A1	44
75 Ohm N Male		PE9737	B1	44
75 Ohm PAL Jack		PE9634	C3	43
75 Ohm PAL Plug		PE9632	E2	43
75 Ohm RCA Plug		PE9633	D2	43
75 Ohm RCA Jack To:		PE9171	C6	23
BNC Male				
75 Ohm RCA Jack To:				
BNC Female		PE9015	C1	24
75 Ohm RCA Plug To:				
75 Ohm F Female		PE9163	D3	43
BNC Female		PE9158	B1	24
75 Ohm SMB In-Series:				
Jack to Jack		PE9248	D6	44
Jack to Plug		PE9245	C6	44
Plug to Plug		PE9271	B6	44
75 Ohm SMB Jack To:				

Connector Type	Feature	Model No.	C/R	Page
SMA Male		PE91003	E7	33
UHF Female		PE9167	D4	42
UHF Male		PE9165	D3	42
75 Ohm F In-Series:				
Female to Female	(P)	PE91349	C1	43
Female to Female		PE9164	D1	43
Female to Female	(B)	PE9734	E1	43
Male to Female	(PO)	PE9160	E7	42
Male to Female		PE9759	A1	43
Male to Female	90°	PE9166	B1	43
Male to Male	(P)	PE91348	C7	42
Male to Male		PE9760	D7	42
75 Ohm F Male To:				
75 Ohm BNC Female		PE9743	C2	43
75 Ohm BNC Male		PE9742	B2	43
75 Ohm N Female		PE9397	C3	44
75 Ohm N Female		PE9739	D3	44
75 Ohm N Male		PE9738	E7	43
75 Ohm PAL Jack		PE9632	E2	43
75 Ohm PAL Plug		PE9633	D2	43
75 Ohm TNC Female		PE91083	B4	45
75 Ohm TNC Male		PE91081	D3	45
BNC Female		PE9151	E7	23
BNC Male		PE9152	E5	23
N Female		PE9389	E7	29
SMA Female		PE91045	A1	36
75 Ohm Mini SMB In-Series:				
Jack to Jack		PE9608	C4	43
Jack to Jack	(B)	PE9611	D4	43
Plug to Jack		PE9610	B4	43
Plug to Plug		PE9609	A4	43
75 Ohm Mini SMB Jack To:				
75 Ohm BNC Female		PE9619	D5	43
75 Ohm BNC Male		PE9618	C5	43
75 Ohm N Female		PE9615	B4	44
75 Ohm N Male		PE9614	D1	44
75 Ohm SMB Plug		PE9736	B7	44
75 Ohm Mini SMB Plug To:				
75 Ohm BNC Female		PE9617	B5	43
75 Ohm BNC Male		PE9616	A5	43
75 Ohm N Female		PE9613	A4	44
75 Ohm N Male		PE9612	C1	44
75 Ohm SMB Jack		PE9735	D7	44
75 Ohm N Female To:				
75 Ohm BNC Female		PE9371	B3	44
75 Ohm BNC Male		PE9368	A3	44
75 Ohm F Female		PE9740	E3	44
75 Ohm F Male		PE9397	C3	44
75 Ohm F Male		PE9739	D3	44
75 Ohm Mini SMB Jack		PE9615	B4	44
75 Ohm Mini SMB Plug		PE9613	A4	44
75 Ohm SMB Jack		PE9583	D4	44
75 Ohm SMB Plug		PE9585	C4	44
75 Ohm SMC Jack		PE9587	A5	44
75 Ohm SMC Plug		PE9589	E4	44
75 Ohm TNC Female		PE9629	C5	44
75 Ohm TNC Male		PE9628	B5	44
75 Ohm N In-Series:				
Female to Female		PE9306	D6	43
Female to Female	(B)	PE9417	E6	43
Female to Female	(B)	PE9416	A7	43
Male to Female		PE9391	B6	43
Male to Female	90°	PE9307	C6	43
Male to Male		PE9308	A6	43
75 Ohm N Male To:				
75 Ohm BNC Female		PE9369	D7	43
75 Ohm BNC Male		PE9370	C7	43
75 Ohm F Female		PE9396	A1	44
75 Ohm F Female		PE9737	B1	44
75 Ohm F Male		PE9738	E7	43
75 Ohm Mini SMB Jack		PE9614	D1	44
75 Ohm Mini SMB Plug		PE9612	C1	44
75 Ohm SMB Jack		PE9582	A2	44
75 Ohm SMB Plug		PE9584	E1	44
75 Ohm SMC Jack		PE9586	B2	44
75 Ohm SMC Plug		PE9588	C2	44
75 Ohm TNC Female		PE9627	E2	44
75 Ohm TNC Male		PE9626	D2	44
75 Ohm PAL In-Series:				
Plug to Plug		PE9680	E5	44
75 Ohm PAL Jack To:				
75 Ohm F Female		PE9634	C3	43
75 Ohm F Male		PE9632	E2	43
75 Ohm PAL Plug To:				
75 Ohm F Male		PE9633	D2	43
75 Ohm Push-On RCA Jack To:				
BNC Male		PE9171	C6	23
75 Ohm RCA Jack To:				
BNC Female		PE9015	C1	24
75 Ohm RCA Plug To:				
75 Ohm F Female		PE9163	D3	43
BNC Female		PE9158	B1	24
75 Ohm SMB In-Series:				
Jack to Jack		PE9248	D6	44
Jack to Plug		PE9245	C6	44
Plug to Plug		PE9271	B6	44
75 Ohm SMB Jack To:				

Connector Type	Feature	Model No.	C/R	Page
75 Ohm Mini SMB Plug		PE9735	D7	44
75 Ohm N Female		PE9583	D4	44
75 Ohm N Male		PE9582	A2	44
BNC Female		PE9231	D1	24
BNC Male		PE9229	C7	44
75 Ohm SMB Plug To:				
75 Ohm Mini SMB Jack		PE9736	B7	44
75 Ohm N Female		PE9585	C4	44
75 Ohm N Male		PE9584	E1	44
BNC Female		PE9232	A7	44
BNC Male		PE9230	D6	23
75 Ohm SMC In-Series:				
Jack to Jack		PE9227	C1	45
Jack to Jack	(B)	PE9228	D1	45
Jack to Plug		PE9244	B1	45
Plug to Plug		PE9272	A1	45
75 Ohm SMC Jack To:				
75 Ohm N Female		PE9587	A5	44
75 Ohm N Male		PE9586	C2	44
BNC Female		PE9235	A2	45
BNC Male		PE91044	A7	23
75 Ohm SMC Plug To:				
75 Ohm N Female		PE9589	E4	44
75 Ohm N Male		PE9588	B2	44
BNC Female		PE9236	E1	24
BNC Male		PE9234	E6	23
75 Ohm TNC Female To:				
75 Ohm BNC Male		PE9630	A4	45
75 Ohm F Female		PE91082	C4	45
75 Ohm F Male		PE91083	B4	45
75 Ohm N Female		PE9629	C5	44
75 Ohm N Male		PE9627	E2	44
75 Ohm TNC In-Series:				
Female to Female		PE9622	D2	45
Female to Female	(B)	PE9625	E2	45
Female to Female	(B)	PE9624	A3	45
Male to Female	90°	PE9623	C2	45
75 Ohm TNC Male To:				
75 Ohm BNC Female		PE9631	C3	45
75 Ohm F Female		PE91080	E3	45
75 Ohm F Male		PE91081	D3	45
75 Ohm N Female		PE9628	B5	44
75 Ohm N Male		PE9626	D2	44
78 Ohm BNC Twinax In-Series:				
Jack to Jack		PE9378	C5	45
Jack to Jack	(B)	PE9280	D5	45
Jack to Plug		PE9375	B5	45
Plug to Jack	90°	PE9377	A5	45
Plug to Plug		PE9376	E4	45
7mm Sexless To:				
2.4mm Male		PE9458	B1	17
2.92mm Female		PE9461	C4	18
2.92mm Male		PE9460	B1	18
3.5mm Female	(P)	PE9325	E3	19
3.5mm Male	(P)	PE9326	A2	19
BNC Female		PE9220	D5	19
BNC Male		PE9221	B5	19
N Female	(P)	PE9216	E4	29
N Male	(P)	PE9217	E3	28
SMA Female	(P)	PE9214	E5	35
SMA Female	(P) (PM)	PE9327	A6	35
SMA Male	(P)	PE9215	B6	33
SSMA Female	(P)	PE9356	A1	40
TNC Female	(P)	PE9218	A6	41
TNC Male	(P)	PE9219	B3	41
95 Ohm 3/4"-20 Twinax In-Series:				
Female to Female		PE9199	B6	45
Female to Female		PE9224	C6	45
Female to Female	(B)	PE9373	D6	45
Female to Male		PE9374	A6	45
Banana Plug To:				
BNC Female		PE9175	A7	45
BMA In-Series:				
Jack to Jack		PE91395	D6	22
BNC Female To:				
10-32 Female		PE9752	A6	22
10-32 Female	(B)	PE9754	B6	22
10-32 Male		PE9753	C5	22
10-32 Male	(B)	PE9755	D5	22
75 Ohm F Female		PE9153	A1	24
75 Ohm F Male		PE9151	E7	23
75 Ohm RCA Jack		PE9015	C1	24
75 Ohm RCA Plug		PE9158	B1	24
75 Ohm SMB Jack		PE9231	D1	24
75 Ohm SMB Plug		PE9232	A7	44
75 Ohm SMC Jack		PE9235	A2	44
75 Ohm SMC Plug		PE9236	E1	24
7mm Sexless		PE9220	D5	19
Banana Plug		PE9175	A7	45
C Female		PE9537	C7	23
C Female	(B)	PE9204	D7	23
C Male		PE9087	B7	23
FME Jack		PE9712	C5	24
GR874 Sexless		PE9222	D6	24
HN Male		PE9126	C2	25
MCX Jack		PE9466	A7	25
MCX Jack	(B)	PE9520	B7	25

Feature: (B) Bulkhead Mount / (H) Hermetically Sealed / (I) Isolated Sealed / (LP) Low PIM / (P) Precision / (PM) Panel Mount / (PO) Push On / (QD) Quick Disconnect / (R) Radius Right Angle / (RU) Ruggedized / (SO) Snap-On

Adapter Locator

Connector Type	Feature	Model No.	C/R	Page
MCX Plug		PE9467	D6	25
Mini UHF Male		PE9342	C4	26
MMCX Jack		PE9516	D7	26
MMCX Plug		PE9519	E6	26
N Female		PE9206	C6	29
N Female	(P)	PE9492	D6	29
N Female	(B)	PE9261	E6	29
N Female	(PM)	PE9238	A7	29
N Female	(B)	PE9540	B7	29
N Male		PE9002	D5	28
N Male	(P)	PE9491	E5	28
N Male	90°	PE9278	A6	33
N Male	(PM)	PE9388	B6	28
SC Female		PE9571	D3	31
SC Male		PE9200	C3	31
SMA Female		PE9075	B7	35
SMA Female		PE9496	C7	35
SMA Female	(B)	PE9185	D7	35
SMA Female	(B)	PE9407	E7	35
SMA Male		PE9074	C7	33
SMA Male		PE9495	D7	33
SMB Jack		PE9136	B6	38
SMB Jack	(B)	PE9240	C6	38
SMB Plug		PE9137	D5	38
SMB Plug	(B)	PE9241	E5	38
SMC Jack		PE9140	D2	39
SMC Jack	(B)	PE9108	E2	39
SMC Plug		PE9141	E1	39
SSMA Male		PE91046	D7	39
SSMB Jack		PE9394	D2	40
SSMB Plug		PE9395	B2	40
TNC Female		PE9097	D6	41
TNC Male		PE9088	D3	41
TNC Male	90°	PE9783	E3	41
UHF Female		PE9421	C4	42
UHF Male		PE91328	C3	42
BNC In-Series:				
Female to Female		PE9084	A3	23
Female to Female		PE9003	B3	23
Female to Female	(B)	PE9420	C3	23
Female to Female	(B)	PE9093	D3	23
Female to Female	(B)	PE9172	E3	23
Female to Female	(PM)	PE9106	A4	23
Female to Male		PE9001	E2	23
Male to Female		PE9269	A2	23
Male to Female	90°	PE9085	B2	23
Male to Female		PE9174	C2	23
Male to Female		PE9484	D2	23
Male to Male		PE9000	D1	23
Male to Male	90°	PE9758	E1	23
BNC Male To:				
10-32 Female		PE9750	E5	22
10-32 Male		PE9751	B5	22
75 Ohm F Female		PE9150	A6	23
75 Ohm F Male		PE9152	E5	23
75 Ohm Push-On RCA Jack		PE9171	C6	23
75 Ohm SMB Jack		PE9229	C7	44
75 Ohm SMB Plug		PE9230	D6	23
75 Ohm SMC Jack		PE91044	A7	23
75 Ohm SMC Plug		PE9234	E6	23
7mm Sexless		PE9221	B5	19
BNC Triax Female		PE91104	B5	23
C Female		PE9109	D5	23
C Male		PE9536	C5	23
Double Banana Binding Post Jack To:				
Post Jack		PE9011	A5	23
FME Jack		PE9711	B5	24
FME Plug		PE9697	E4	24
FME Plug	90°	PE9698	A5	24
FME Plug		PE9698	A5	24
GR874 Sexless		PE9223	C6	24
HN Female		PE9129	C3	25
HN Male		PE9567	B2	25
MCX Jack		PE9468	E6	25
MCX Plug		PE9469	C6	25
MHV Female		PE9406	B6	23
Mini UHF Female		PE9341	B5	26
MMCX Jack		PE9518	C7	26
MMCX Plug		PE9517	D6	26
N Female		PE9005	D5	29
N Female	(P)	PE9490	E5	29
N Female	90°	PE9566	A6	29
N Female	(PM)	PE9123	B6	29
N Male		PE9127	A5	28
N Male	(P)	PE9489	B5	28
N Male	90°	PE9565	C5	28
Reverse Polarity TNC Female		PE91067	D1	42
SC Male		PE9568	B3	31
SMA Female		PE9073	E6	35
SMA Female		PE9494	A7	35
SMA Male		PE9072	A7	33
SMA Male		PE9493	B7	33
SMB Jack		PE9132	A6	38
SMB Plug		PE9135	C5	38
SMC Jack		PE9138	C2	39
SMC Plug		PE9139	D1	39
SSMA Female		PE9191	B1	40
SSMA Male		PE9213	C7	39

Connector Type	Feature	Model No.	C/R	Page
SSMB Jack		PE9392	C2	40
SSMB Plug		PE9393	A2	40
TNC Female		PE9098	C6	41
UHF Female		PE91329	B4	42
UHF Male		PE9201	B3	42
BNC Triax Female To:				
BNC Male		PE91104	B5	23
BNC Triax In-Series:				
Female to Female		PE91107	D7	45
Female to Female	(B)	PE91105	E7	45
Male to Female		PE91106	C7	45
C Female To:				
BNC Female		PE9537	C7	23
BNC Female	(B)	PE9204	D7	23
BNC Male		PE9109	D5	23
GR874 Sexless		PE9301	E6	24
HN Male		PE9296	E2	25
N Female		PE9539	D7	29
N Male		PE91446	D6	28
N Male	90°	PE9239	E6	28
TNC Male		PE9562	A4	41
C In-Series:				
Female to Female		PE9208	E2	24
Female to Female		PE9294	A3	24
Female to Female	(B)	PE9186	B3	24
Female to Male		PE9207	D2	24
Male to Female	90°	PE9293	C2	24
Male to Male		PE9300	B2	24
C Male To:				
BNC Female		PE9087	B7	23
BNC Male		PE9536	C5	23
HN Female		PE9212	D3	25
HN Male		PE9579	D2	25
N Female		PE9295	C7	29
N Male		PE9538	C6	28
TNC Female		PE9564	E6	41
Double Banana Binding Post Jack To:				
BNC Male		PE9011	A5	23
D-Sub In-Series:				
Plug to Plug		PE9688	D3	24
Plug to Receptacle		PE9687	E3	24
Receptacle to Receptacle		PE9689	A4	24
FME In-Series:				
Plug to Plug		PE9696	C4	24
FME Jack To:				
BNC Female		PE9712	C5	24
BNC Male		PE9711	B5	24
Mini UHF Female		PE9710	C5	26
Mini UHF Male		PE9709	A5	26
SMA Female		PE9708	D1	36
SMA Male		PE9707	A1	34
TNC Female		PE9714	A7	41
TNC Male		PE9713	D4	41
FME Plug To:				
BNC Male		PE9697	E4	24
BNC Male	90°	PE9698	A5	24
Mini UHF Male		PE9705	D4	26
Mini UHF Male	90°	PE9706	E4	26
N Male		PE9704	B7	28
SMA Female		PE9703	C1	36
TNC Male		PE9699	B4	41
TNC Male	90°	PE9700	C4	41
UHF Male		PE9701	E3	42
Full Detent Mini SMP Male To:				
2.4mm Female		PE91122	D2	17
2.4mm Male		PE91121	C1	17
2.92mm Female		PE91127	E4	18
SMA Female		PE91299	E2	36
SMA Female		PE91129	A3	36
SMA Male		PE91302	B2	34
SMA Male	(P)	PE91052	D2	34
Full Detent SMP Male To:				
SMA Female		PE91305	B1	37
SMA Female	(P)	PE91056	C1	37
SMA Female	(B)	PE91054	D1	37
SMA Female	(P) (PM)	PE91058	E1	37
SMA Male		PE91309	E6	34
SMA Male	(P)	PE91063	C7	34
GR874 In-Series:				
Sexless to Sexless	90°	PE9286	E5	24
Sexless to Sexless		PE9285	A6	24
GR874 Sexless To:				
BNC Female		PE9222	D6	24
BNC Male		PE9223	C6	24
C Female		PE9301	E6	24
HN Female		PE9387	E3	25
HN Male		PE9386	A3	25
N Female		PE9258	A1	30
N Male		PE9257	C7	28
SMA Female		PE9260	E1	36
SMA Male		PE9259	B1	34
HN Female To:				
7/16 DIN Male		PE9558	B6	21
BNC Male		PE9129	C3	25
C Male		PE9212	D3	25
GR874 Sexless		PE9387	E3	25
LC Male		PE9181	A5	25

Connector Type	Feature	Model No.	C/R	Page
N Female		PE9360	C1	30
N Female	(PM)	PE9553	D1	30
N Male		PE9125	E7	28
SMA Female		PE9255	B2	36
SMA Male		PE9256	D1	34
HN In-Series:				
Female to Female		PE9580	C1	25
Female to Female		PE9574	D1	25
Female to Female	(B)	PE9193	E1	25
Female to Male		PE9575	B1	25
Male to Female		PE9576	D7	24
Male to Female	90°	PE9205	E7	24
Male to Female		PE9578	A1	25
Male to Male		PE9210	B7	24
Male to Male	90°	PE9577	C7	24
HN Male To:				
7/16 DIN Female		PE9559	A3	22
BNC Female		PE9126	C2	25
BNC Male		PE9567	B2	25
C Female		PE9296	E2	25
C Male		PE9579	D2	25
GR874 Sexless		PE9386	A3	25
LC Female		PE9413	B5	25
MHV Female		PE9264	B3	25
N Female		PE9194	B1	30
N Male		PE9554	D7	28
SMA Female		PE9253	A2	36
SMA Male		PE91448	C1	34
TNC Male		PE9563	E4	41
LC Female To:				
HN Male		PE9413	B5	25
N Female		PE9298	A2	30
N Male		PE9299	A1	29
LC In-Series:				
Female to Female		PE9419	D4	25
Female to Female	90°	PE9398	C4	25
Male to Male		PE9569	B4	25
LC Male To:				
HN Female		PE9181	A5	25
N Female		PE9237	E1	30
Limited Detent SMP Male To:				
SMA Female		PE91306	A2	37
SMA Female	(P)	PE91050	B2	37
SMA Female	(P)	PE9512	C2	37
SMA Female		PE9778	D2	37
SMA Female	(P) (PM)	PE91066	E2	37
SMA Male		PE91310	A7	34
SMA Male	(P)	PE9511	D7	34
TNC Female	(B)	PE91073	A1	42
MCX In-Series:				
Jack to Jack		PE9524	E5	25
Jack to Jack	(B)	PE9474	A6	25
Plug to Jack		PE9479	D5	25
MCX Jack To:				
BNC Female		PE9466	A7	25
BNC Female	(B)	PE9520	B7	25
BNC Male		PE9468	E6	25
MMCX Jack		PE9526	A1	27
MMCX Plug		PE9525	B7	26
N Female		PE9462	C2	30
N Male		PE9464	C1	29
SMA Female		PE9470	D2	36
SMA Male		PE9472	A2	34
TNC Female		PE9544	C7	41
TNC Female	(B)	PE9521	D7	41
TNC Male		PE9542	B5	41
MCX Plug To:				
BNC Female		PE9467	D6	25
BNC Male		PE9469	C6	25
MMCX Jack		PE9528	E7	26
MMCX Plug		PE9527	A7	26
N Female		PE9463	B2	30
N Male		PE9465	B1	29
SMA Female		PE9471	C2	36
SMA Male		PE9473	E1	34
TNC Female		PE9545	B7	41
TNC Male		PE9543	A5	41
MHV Female To:				
BNC Male		PE9406	B6	23
HN Male		PE9264	B3	25
SHV Jack		PE9339	C2	26
SHV Plug		PE9265	B2	26
MHV In-Series:				
Female to Female		PE9267	B1	26
Female to Female	(B)	PE9268	C1	26
Female to Male		PE9211	A1	26
Male to Female		PE9297	D7	25
Male to Female	90°	PE9266	E7	25
MHV Male To:				
SHV Jack		PE9335	A2	26
SHV Plug		PE9340	E1	26
Mini SMP Female To:				
2.4mm Female		PE91123	E2	17
2.4mm Male		PE91120	D1	17
2.92mm Female		PE9782	B5	18
2.92mm Male		PE91126	E1	18

Feature: (B) Bulkhead Mount / (H) Hermetically Sealed / (I) Isolated Sealed / (LP) Low PIM / (P) Precision / (PM) Panel Mount / (PO) Push On / (QD) Quick Disconnect / (R) Radius Right Angle / (RU) Ruggedized / (SO) Snap-On

Adapter Locator

Connector Type	Feature	Model No.	C/R	Page
SMA Female		PE91301	C3	36
SMA Female	(P)	PE91051	D3	36
SMA Female		PE91304	E2	34
SMA Male	(P)	PE91103	A3	34
Mini SMP In-Series:				
Female to Female		PE9780	E2	26
Female to Female		PE91069	A3	26
Mini SMP Male To:				
2.92mm Female		PE9781	D4	18
2.92mm Male		PE91124	C1	18
Mini UHF Female To:				
BNC Male		PE9341	B5	26
FME Jack		PE9710	C5	26
N Male		PE9064	D1	29
TNC Male		PE9345	C5	41
UHF Male		PE9348	A4	42
Mini UHF In-Series:				
Female to Female		PE9343	E3	26
Female to Female		PE9066	A4	26
Female to Male		PE9065	D3	26
Male to Female	90°	PE9347	C3	26
Mini UHF Male To:				
BNC Female		PE9342	C4	26
FME Jack		PE9709	A5	26
FME Plug		PE9705	D4	26
FME Plug	90°	PE9706	E4	26
N Female		PE9183	D2	30
TNC Female		PE9346	E7	41
UHF Female		PE91447	E4	42
MMBX In-Series:				
Plug to Plug	(SO)	PE91370	C1	27
Plug to Plug	(SO)	PE91373	D1	27
Plug to Plug		PE91371	E1	27
Plug to Plug	(SO)	PE91372	A2	27
MMCX In-Series:				
Jack to Jack		PE9523	A6	26
Jack to Jack	(B)	PE9522	B6	26
Plug to Jack		PE9480	E5	26
MMCX Jack To:				
BNC Female		PE9516	D7	26
BNC Male		PE9518	C7	26
MCX Jack		PE9526	A1	27
MCX Plug		PE9528	E7	26
SMA Female		PE9477	A4	36
SMA Male		PE9478	C3	34
MMCX Plug To:				
BNC Female		PE9519	E6	26
BNC Male		PE9517	D6	26
MCX Jack		PE9525	B7	26
MCX Plug		PE9527	A7	26
SMA Female		PE9475	E3	36
SMA Male		PE9476	B3	34
N Female To:				
1.85mm Female		PE9721	E5	16
1.85mm Male		PE9719	A5	16
2.4mm Female	(P)	PE9502	B3	17
2.4mm Male	(P)	PE9501	A2	17
2.92mm Female	(P)	PE9664	D5	18
2.92mm Male	(P)	PE9662	B2	18
3.5mm Female	(P)	PE9323	B4	19
3.5mm Male	(P)	PE9324	C2	19
4.1/9.5 Mini DIN Female		PE91218	B2	20
4.1/9.5 Mini DIN Female		PE91255	C2	20
4.1/9.5 Mini DIN Female	(LP)	PE91095	E2	20
4.1/9.5 Mini DIN Female	(B)	PE91220	D2	20
4.1/9.5 Mini DIN Female	(B)	PE91257	A3	20
4.1/9.5 Mini DIN Male		PE91217	A1	20
4.1/9.5 Mini DIN Male		PE91254	B1	20
4.1/9.5 Mini DIN Male	(LP)	PE91093	C1	20
4.3-10 Female	(LP)	PE91475	A7	20
4.3-10 Male	(LP)	PE91474	C5	20
4.3-10 Male	(LP)	PE91477	D5	20
4.3-10 Male	(LP) 90°	PE91483	A6	20
4.3-10 Male	(LP)	PE91389	B6	20
7/16 DIN Female	(LP)	PE91033	B5	29
7/16 DIN Female	(LP)	PE9180	C5	29
7/16 DIN Female		PE91213	D3	22
7/16 DIN Female		PE91250	E3	22
7/16 DIN Female	(B)	PE91215	A4	22
7/16 DIN Female	(B)	PE91252	B4	22
7/16 DIN Male	(LP)	PE91031	A5	29
7/16 DIN Male		PE91212	E6	21
7/16 DIN Male		PE91249	A7	21
75 Ohm F Male		PE9389	E7	29
7mm Sexless	(P)	PE9216	E4	29
BNC Female		PE9206	C6	29
BNC Female	(P)	PE9492	D6	29
BNC Female	(B)	PE9261	E6	29
BNC Female	(PM)	PE9238	A7	29
BNC Female	(B)	PE9540	B7	29
BNC Male		PE9005	D5	29
BNC Male	(P)	PE9490	E5	29
BNC Male	90°	PE9566	A6	29
BNC Male	(PM)	PE9123	B6	29
C Female		PE9539	D7	29
C Male		PE9295	C7	29
GR874 Sexless		PE9258	A1	30

Connector Type	Feature	Model No.	C/R	Page
HN Female		PE9360	C1	30
HN Female	(PM)	PE9553	D1	30
HN Male		PE9194	B1	30
LC Female		PE9298	A2	30
LC Male		PE9237	E1	30
MCX Jack		PE9462	C2	30
MCX Plug		PE9463	B2	30
Mini UHF Male		PE9183	D2	30
QD 4.3-10 Female	(LP) (QD)	PE91482	B7	20
QD 4.3-10 Male	(LP) (QD)	PE91478	E5	20
Reverse Polarity SMA Male		PE9732	C1	38
Reverse Polarity TNC Male		PE9731	D6	30
SC Female		PE9292	A3	30
SC Male		PE9277	E2	30
SMA Female	(P)	PE9083	D5	36
SMA Female	(B)	PE9432	E5	36
SMA Female	(B) (P)	PE9252	A6	36
SMA Female	(PM)	PE9486	B6	36
SMA Female	(P) (PM)	PE9104	C6	36
SMA Female	(B)	PE9434	D6	36
SMA Female	(B) (P)	PE9408	E6	36
SMA Female	(B) (P)	PE9435	A7	36
SMA Male	(LP)	PE91178	B3	30
SMA Male		PE9082	D4	34
SMA Male	(P)	PE9433	E4	34
SMA Male	(B) (P)	PE9487	A5	34
SMA Male	(PM)	PE9105	B5	34
SMA Male	(P) (PM)	PE9497	C5	34
SMA Male	(B) (P)	PE9488	D5	34
SMB Jack		PE9315	D3	30
SMB Plug		PE9316	C3	30
SMC Jack		PE9319	A4	30
SMC Plug		PE9320	E3	30
SSMA Female		PE9354	D1	40
TNC Female		PE9131	E4	30
TNC Female	(P)	PE9449	A5	30
TNC Female	(PM)	PE9552	B5	30
TNC Female	(B)	PE9482	C5	30
TNC Female	(P) (PM)	PE9450	D5	30
TNC Male		PE9089	B4	30
TNC Male	(P)	PE91506	C4	30
TNC Male	90°	PE9263	D4	30
UHF Female		PE9385	A6	30
UHF Male		PE9112	E5	30
N In-Series:				
Female to Female		PE91200	B6	27
Female to Female		PE91237	C6	27
Female to Female		PE9006	D6	27
Female to Female	(LP)	PE91140	E6	27
Female to Female		PE91141	A7	27
Female to Female	90°	PE9359	B7	27
Female to Female		PE9101	C7	27
Female to Female		PE9548	D7	27
Female to Female	(B)	PE9128	E7	27
Female to Female	(B)	PE9383	A1	28
Female to Female	(B) 90°	PE9541	B1	28
Female to Female	(PM)	PE9173	C1	28
Female to Female	(P) (PM)	PE9429	D1	28
Female to Female	(B)	PE91201	E1	28
Female to Female	(B)	PE91238	A2	28
Female to Female	(B) (LP)	PE91179	B2	28
Female to Female	(B) (P)	PE9500	C2	28
Female to Female	(B)	PE9382	D2	28
Female to Male		PE9350	E5	27
Female to Male		PE9102	A6	27
Female to Male		PE91199	D3	27
Female to Male		PE91236	E3	27
Female to Male	(LP)	PE91040	A4	27
Female to Male	(PO)	PE91114	B4	27
Female to Male		PE9311	C4	27
Female to Male		PE9349	D4	27
Female to Male	(QD)	PE9547	E4	27
Female to Male	(P) (R)	PE91350	A5	27
Female to Male	90°	PE9086	B5	27
Female to Male		PE9481	C5	27
Female to Male	(B)	PE9595	D5	27
Female to Male		PE91198	C2	27
Female to Male		PE91235	D2	27
Female to Male		PE9007	E2	27
Female to Male	(LP)	PE91034	A3	27
Female to Male	90°	PE9198	B3	27
Female to Male		PE9390	C3	27
N Male To:				
1.85mm Female		PE9720	D5	16
1.85mm Male		PE9718	E4	16
2.4mm Female	(P)	PE9503	A3	17
2.4mm Male	(P)	PE9504	E1	17
2.92mm Female	(P)	PE9663	C5	18
2.92mm Male	(P)	PE9661	A2	18
3.5mm Female	(P)	PE9321	A4	19
3.5mm Male	(P)	PE9322	B2	19
4.1/9.5 Mini DIN Female		PE91219	D1	20
4.1/9.5 Mini DIN Female	(LP)	PE91256	E1	20
4.1/9.5 Mini DIN Male		PE91094	A2	20
4.1/9.5 Mini DIN Male		PE91216	C7	19
4.1/9.5 Mini DIN Male		PE91253	D7	19
4.1/9.5 Mini DIN Male	(LP)	PE91092	E7	19

Connector Type	Feature	Model No.	C/R	Page
4.3-10 Female	(LP)	PE91388	A4	28
4.3-10 Female	(LP)	PE91479	D6	20
4.3-10 Male	(LP)	PE91476	A5	20
7/16 DIN Female	(LP)	PE91032	D4	28
7/16 DIN Female		PE91134	E4	28
7/16 DIN Female		PE91214	B3	22
7/16 DIN Female		PE91251	C3	22
7/16 DIN Male	(LP)	PE91030	B4	28
7/16 DIN Male		PE9535	C4	28
7/16 DIN Male		PE91211	C6	21
7/16 DIN Male		PE91248	D6	21
75 Ohm F Female		PE9155	A7	28
7mm Sexless	(P)	PE9217	E3	28
BNC Female		PE9002	D5	28
BNC Female	(P)	PE9491	E5	28
BNC Female	90°	PE9278	A6	28
BNC Female	(PM)	PE9388	B6	28
BNC Male		PE9127	A5	28
BNC Male	(P)	PE9489	B5	28
BNC Male	90°	PE9565	C5	28
C Female		PE91446	D6	28
C Female	90°	PE9239	E6	28
C Male		PE9538	C6	28
FME Plug		PE9704	B7	28
GR874 Sexless		PE9257	C7	28
HN Female		PE9125	E7	28
HN Male		PE9554	D7	28
LC Female		PE9299	A1	29
MCX Jack		PE9464	C1	29
MCX Plug		PE9465	B1	29
Mini UHF Female		PE9064	D1	29
QD 4.3-10 Female	(LP) (QD)	PE91481	E6	20
QD 4.3-10 Male	(LP) (QD)	PE91480	B5	20
QMA Female		PE9787	E1	29
Reverse Polarity SMA Female		PE9733	A2	38
Reverse Polarity TNC Female		PE9730	C6	30
SC Female		PE9196	B2	29
SC Male		PE9570	A2	29
SMA Female	(LP)	PE91177	C2	29
SMA Female		PE9081	D4	36
SMA Female	(B)	PE9551	A5	36
SMA Female	(PM)	PE9275	B5	36

Adapter Locator

Adapters

Connector Type	Feature	Model No.	C/R	Page	Connector Type	Feature	Model No.	C/R	Page	Connector Type	Feature	Model No.	C/R	Page
Reverse Polarity TNC Male		PE9607	A3	38	1.85mm Female		PE9729	C4	35	TNC Male		PE9440	E5	37
TNC Female		PE9599	C2	38	1.85mm Male		PE9726	B4	35	UHF Male		PE9415	E6	37
TNC Male		PE9598	B2	38	2.4mm Female (P)		PE9656	E4	35	UMCX Jack		PE91006	B7	37
Reverse Polarity SMA In-Series:					2.4mm Male		PE9655	D4	35	UMCX Plug		PE91005	A7	37
Female to Female		PE91260	E7	32	2.4mm NMD Female (RU)		PE91146	B4	17	SMA In-Series:				
Female to Female		PE91262	D2	33	2.92mm Female (P)		PE91011	B5	35	Female to Female		PE9070	C3	32
Female to Female		PE91334	E2	33	2.92mm Male (P)		PE91009	A5	35	Female to Female		PE9380	D3	32
Female to Female	(B)	PE9593	A3	33	3.5mm Female		PE9725	D5	35	Female to Female (P)		PE9507	E3	32
Female to Female	(PM)	PE91270	B3	33	3.5mm Male		PE9724	C5	35	Female to Female (P)	90°	PE9695	A4	32
Female to Female	(PM)	PE91269	C3	33	3.5mm NMD Female (RU)		PE91147	E4	19	Female to Female (P)	90°	PE9485	B4	32
Female to Male		PE9533	D7	32	4.3-10 Male (LP)		PE91484	C6	20	Female to Female (P)	90°	PE9246	C4	32
Male to Female (QD)		PE91265	A7	32	7/16 DIN Female (LP)		PE91042	D6	35	Female to Female (B)		PE91258	D4	32
Male to Female		PE9534	B7	32	7/16 DIN Male (LP)		PE91036	B6	35	Female to Female (B)		PE9508	E4	32
Male to Female	90°	PE91264	C7	32	75 Ohm F Female		PE91175	C6	35	Female to Female (B) (P)		PE9620	A5	32
Male to Female	(QD)	PE91267	B1	33	75 Ohm F Male		PE91002	B1	36	Female to Female (H) (B)		PE91393	B5	32
Male to Female	90°	PE91263	C1	33	7mm Sexless (P)		PE9214	E5	35	Female to Female (B)		PE9184	C5	32
Male to Female	(QD)	PE91268	A2	33	7mm Sexless (P) (PM)		PE9327	A6	35	Female to Female (B)		PE9067	D5	32
Male to Female		PE91331	B2	33	BNC Female		PE9075	B7	35	Female to Female (PM)		PE9312	E5	32
Male to Female	90°	PE9594	C2	33	BNC Female		PE9496	C7	35	Female to Female (PM)		PE9670	A6	32
Male to Male		PE91259	E6	32	BNC Female (B)		PE9185	D7	35	Female to Female (B)		PE9184NH	B6	32
Male to Male (QD)		PE91266	A1	33	BNC Female (B)		PE9407	E7	35	Female to Female (PM)		PE91290	C6	32
Male to Male		PE91261	D1	33	BNC Male		PE9073	E6	35	Female to Male		PE9182	B3	32
Male to Male		PE91330	E1	33	BNC Male		PE9494	A7	35	Male to Female (QD)		PE9103	A7	31
Reverse Polarity SMA Male To:					BNC Male		PE9708	D1	36	Male to Female (P)		PE9694	B7	31
N Female		PE9732	C1	38	FME Jack		PE9703	C1	36	Male to Female (P) (QD)		PE9774	D7	31
Reverse Polarity TNC Female		PE9604	E2	38	FME Plug					Male to Female (R)		PE91492	E7	31
Reverse Polarity TNC Male		PE9605	D2	38	Full Detent Mini SMP Male		PE91299	E2	36	Male to Female (R)		PE91493	A1	32
TNC Female		PE9596	E1	38	Full Detent Mini SMP Male		PE91129	A3	36	Male to Female (R)		PE91155	B1	32
TNC Male		PE9597	D1	38	Full Detent SMP Male		PE91305	B1	37	Male to Female (R)		PE91222	C1	32
Reverse Polarity TNC Female To:					Full Detent SMP Male (P)		PE91056	C1	37	Male to Female (R)	90°	PE9068	D1	32
BNC Male		PE91087	D1	42	Full Detent SMP Male (B)		PE91054	D1	37	Male to Female (P) 45°		PE91332	E1	32
N Male		PE9730	C6	30	Full Detent SMP Male (P) (PM)		PE91058	E1	37	Male to Female (P) 90°		PE91149	B2	32
Reverse Polarity SMA Female		PE9606	B3	38	GR874 Sexless		PE9260	E1	36	Male to Female (B)		PE91504	C2	32
Reverse Polarity SMA Male		PE9604	E2	38	HN Female		PE9255	B2	36	Male to Female (B)		PE9014	D2	32
SMA Female		PE9603	B1	38	HN Male		PE9253	A2	36	Male to Female (B)		PE9621	E2	32
SMA Male		PE9600	E7	37	Limited Detent SMP Male		PE91306	A2	37	Male to Female (B) (PO)		PE91321	A3	32
Reverse Polarity TNC In-Series:					Limited Detent SMP Male (P)		PE91050	B2	37	Male to Male (P)		PE91135	B5	31
Female to Male		PE9531	D2	41	Limited Detent SMP Male (P)		PE9512	C2	37	Male to Male (R)		PE91327	D5	31
Male to Female		PE9532	C2	41	Limited Detent SMP Male (P) (PM)		PE9778	D2	37	Male to Male (P) (R)		PE91458	E5	31
Male to Female 90°		PE9918	E2	41	Limited Detent SMP Male		PE91066	E2	37	Male to Male 90°		PE9418	A6	31
Reverse Polarity TNC Male To:					MCX Jack		PE9470	D2	36	Male to Male		PE9379	B6	31
N Female		PE9731	D6	30	MCX Plug		PE9471	C2	36	Male to Male (P) 90°		PE91151	C6	31
Reverse Polarity SMA Female		PE9607	A3	38	Mini SMP Female		PE91301	C3	36	Male to Male (R) 90°		PE9642	D6	31
Reverse Polarity SMA Male		PE9605	D2	38	Mini SMP Female (P)		PE91051	D3	36	Male to Male (PM) 90°		PE9669	E6	31
SMA Female		PE9602	A1	38	MMCX Jack		PE9477	A4	36	SMA Male To:				
SMA Male		PE9600	E7	37	MMCX Plug		PE9475	E3	36	1.0/2.3 Jack		PE9690	D4	33
Reverse Thread SMA In-Series:					N Female		PE9083	D5	36	1.0/2.3 Plug		PE9692	C4	33
Female to Male		PE9683	A4	33	N Female (B)		PE9432	E5	36	1.85mm Female		PE9728	A5	33
Male to Female		PE9682	E3	33	N Female (B) (P)		PE9252	A6	36	1.85mm Male		PE9727	E4	33
SC Female To:					N Female (PM)		PE9486	B6	36	2.4mm Female (P)		PE9654	C5	33
7/16 DIN Male		PE91444	B7	21	N Female (P) (PM)		PE9104	C6	36	2.4mm Male (P)		PE9653	B5	33
BNC Female		PE9571	D3	31	N Female (B)		PE9434	D6	36	2.92mm Female (P)		PE91008	E5	33
N Female		PE9292	A3	30	N Female (B) (P)		PE9408	E6	36	2.92mm Male (P)		PE91010	D5	33
N Male		PE9196	B2	29	N Male		PE9435	A7	36	3.5mm Male		PE9722	A6	33
SC In-Series:					N Male (B)		PE9081	D4	36	7/16 DIN Female (LP)		PE91041	D6	33
Female to Female		PE9404	D2	31	N Male (PM)		PE9551	A5	36	7/16 DIN Female (LP)		PE91043	E6	33
Female to Female (B)		PE9573	E2	31	N Male (P) (PM)		PE9275	B5	36	7/16 DIN Male		PE91003	E7	33
Female to Male		PE9225	C2	31	N Male (LP)		PE91177	C2	29	75 Ohm F Female (P)		PE9215	B6	33
Male to Female		PE9572	A2	31	N Male (PO)		PE91336	E5	34	7mm Sexless		PE9074	C7	33
Male to Female 90°		PE9405	B2	31	QD N Male (QD)		PE9684	E4	36	BNC Female		PE9495	D7	33
Male to Male		PE9403	E1	31	QMA Male		PE9786	B7	36	BNC Male		PE9072	A7	33
SC Male To:					Female		PE9603	B1	38	BNC Male		PE9493	B7	33
BNC Female		PE9200	C3	31	Reverse Polarity TNC Male		PE9602	A1	38	FME Jack		PE9707	A1	34
BNC Male		PE9568	B3	31	Slide-On BMA Jack		PE91400	A1	23	Full Detent Mini SMP Male		PE91302	B2	34
N Female		PE9277	E2	30	Slide-On BMA Jack (PM)		PE91399	B1	23	Full Detent Mini SMP Male (P)		PE91052	D2	34
N Male		PE9570	A2	29	Slide-On BMA Plug		PE91398	C7	22	Full Detent SMP Male		PE91309	E6	34
SHV In-Series:					Slide-On BMA Plug (B)		PE91402	D7	22	Full Detent SMP Male (P)		PE91063	C7	34
Jack to Jack		PE9337	D4	31	SMB Jack		PE9143	D7	36	GR874 Sexless		PE9259	B1	34
Jack to Jack (B)		PE9336	E4	31	SMB Plug		PE9142	C7	36	HN Female		PE9256	D1	34
Jack to Plug		PE9249	C4	31	SMB Jack		PE9147	A1	37	HN Male		PE91448	C1	34
Plug to Jack		PE9749	A4	31	SMC Plug		PE9146	E7	36	Limited Detent SMP Male		PE91310	A7	34
Plug to Jack 90°		PE9338	B4	31	SMC Jack		PE91300	B3	36	Limited Detent SMP Male (P)		PE9511	D7	34
MHV Female		PE9339	C2	26	Smooth Bore Mini SMP Male		PE91307	A3	37	MCX Jack		PE9472	A2	34
MHV Male		PE9335	A2	26	Smooth Bore SMP Male (P)		PE91049	B3	37	MCX Plug		PE9473	E1	34
SHV Plug To:					Smooth Bore SMP Male (P) (PM)		PE91061	C3	37	Mini SMP Female		PE91304	E2	34
MHV Female		PE9265	B2	26	SMP Female		PE91308	A4	37	Mini SMP Female (P)		PE91103	A3	34
MHV Male		PE9340	E1	26	SMP Female (P)		PE91064	B4	37	MMCX Jack		PE9478	C3	34
Slide-On BMA Jack To:					SMP Female (P)		PE9779	A4	37	MMCX Plug		PE9082	D4	34
SMA Female		PE91400	A1	23	SMP Male (P) (PM)		PE91059	D3	37	N Female (P)		PE9433	E4	34
SMA Female (PM)		PE91399	B1	23	SMP Male (P) (PM)		PE91057	D3	37	N Female (B) (P)		PE9487	A5	34
SMA Male		PE91397	E7	22	SMP Male (P) (PM)		PE91059	E3	37	N Female (PM)		PE91005	B5	34
Slide-On BMA Plug To:					Snap-On MMBX Jack (SO)		PE91363	C4	36	N Female (P) (PM)		PE9497	C5	34
SMA Female		PE91398	C7	22	Snap-On MMBX Plug (SO)		PE91361	B4	36	N Female (B) (P)		PE9488	D5	34
SMA Female (B)		PE91402	D7	22	Snap-On QMA Male (SO)		PE91345	A1	31	N Female (LP)		PE91178	B3	30
SMA Male		PE91396	A7	22	SSMA Female		PE9399	E4	37	N Male		PE9080	A4	34
SMA Male (B)		PE91401	B7	22	SSMA Male		PE9188	D4	37	N Male (P)		PE9431	B4	34
SMA Female To:					SSMB Plug		PE9402	A5	37	N Male (P) (PM)		PE9499	C4	34
1.0/2.3 Jack		PE9693	A4	35	SSMC Jack		PE91433	C5	37	Reverse Polarity MCX Plug		PE9581	D7	37
1.0/2.3 Plug		PE9691	E3	35	SSMC Plug		PE91380	B5	37	Reverse Polarity TNC Female		PE9600	E7	37
					TNC Female		PE9079	A6	37	Reverse Polarity TNC Male				
					TNC Female (B)		PE9442	B6	37					
					TNC Female (PM)		PE9251	C6	37					
					TNC Male		PE9276	D6	37					
							PE9077	D5	37					

Feature: (B) Bulkhead Mount / (H) Hermetically Sealed / (I) Isolated Sealed / (LP) Low PIM / (P) Precision / (PM) Panel Mount / (PO) Push On / (QD) Quick Disconnect / (R) Radius Right Angle / (RU) Ruggedized / (SO) Snap-On

Adapter Locator

Adapters

Connector Type	Feature	Model No.	C/R	Page
Slide-On BMA Jack		PE91397	E7	22
Slide-On BMA Plug		PE91396	A7	22
Slide-On BMA Plug	(B)	PE91401	B7	22
SMB Jack		PE9145	B6	34
SMB Plug		PE9144	A6	34
SMC Jack		PE9149	D6	34
SMC Plug		PE9148	C6	34
Smooth Bore Mini SMP Male		PE91303	C2	34
Smooth Bore SMP Male		PE91311	B7	34
SMP Female		PE91312	E7	34
SMP Female	(P)	PE91062	A1	35
SMP Female	(P)	PE9513	B1	35
Snap-On MMBX Jack	(SO)	PE91362	E3	34
Snap-On MMBX Plug	(SO)	PE91360	D3	34
Snap-On QMA Female	(SO)	PE91346	B1	31
SSMA Female		PE9063	D1	35
SSMA Male		PE9187	C1	35
SSMB Jack		PE9401	E1	35
TNC Female		PE9078	C2	35
TNC Female		PE91507	E2	35
TNC Female	(PM)	PE9384	B3	35
TNC Male		PE9076	A2	35
TNC Male		PE9439	B2	35
UHF Female		PE9400	C3	35
UMCX Jack		PE91007	D3	35
SMB In-Series:				
Jack to Jack		PE9116	D4	38
Jack to Jack		PE9302	E4	38
Jack to Jack	(B)	PE9122	A5	38
Jack to Plug		PE9243	C4	38
Plug to Jack		PE9120	A4	38
Plug to Jack		PE9309	B4	38
Plug to Plug		PE9118	D3	38
Plug to Plug		PE9310	E3	38
SMB Jack To:				
BNC Female		PE9136	B6	38
BNC Female	(B)	PE9240	C6	38
BNC Male		PE9132	A6	38
N Female		PE9315	D3	30
N Male		PE9313	E2	29
SMA Female		PE9143	D7	36
SMA Male		PE9145	B6	34
SMC Jack		PE9283	B3	39
SMC Plug		PE9284	B2	39
SMB Plug To:				
BNC Female		PE9137	D5	38
BNC Female	(B)	PE9241	E5	38
BNC Male		PE9135	C5	38
N Female		PE9316	C3	30
N Male		PE9314	D2	29
SMA Female		PE9142	C7	36
SMA Male		PE9144	A6	34
SMC Jack		PE9282	A3	39
SMC Plug		PE9281	A2	39
SMC In-Series:				
Jack to Jack		PE9115	E7	38
Jack to Jack		PE9304	A1	39
Jack to Jack	(B) (PM)	PE91403	B1	39
Jack to Plug		PE9242	D7	38
Plug to Jack		PE9119	B7	38
Plug to Jack	90°	PE9303	C7	38
Plug to Plug		PE9117	E6	38
Plug to Plug		PE9305	A7	38
SMC Jack To:				
BNC Female		PE9140	D2	39
BNC Female	(B)	PE9108	E2	39
BNC Male		PE9138	C2	39
N Female		PE9319	A4	30
N Male		PE9317	B3	29
SMA Female		PE9147	A1	37
SMA Male		PE9149	D6	34
SMB Jack		PE9283	B3	39
SMB Plug		PE9282	A3	39
TNC Male		PE9226	D5	41
SMC Plug To:				
BNC Female		PE9141	E1	39
BNC Male		PE9139	D1	39
N Female		PE9320	E3	30
N Male		PE9318	A3	29
SMA Female		PE9146	E7	36
SMA Male		PE9148	C6	34
SMB Jack		PE9284	B2	39
SMB Plug		PE9281	A2	39
Smooth Bore Mini SMP Male To:				
2.92mm Female		PE91128	A5	18
2.92mm Male		PE91125	D1	18
SMA Female		PE91300	B3	36
SMA Male		PE91303	C2	34
Smooth Bore SMP Male To:				
SMA Female		PE91307	A3	37
SMA Female	(P)	PE91049	B3	37
SMA Female	(P) (PM)	PE91061	C3	37
SMA Male		PE91311	B7	34
SMP Female To:				
2.4mm Female		PE91055	D3	17
2.92mm Female		PE91060	E5	18

Connector Type	Feature	Model No.	C/R	Page
SMA Female		PE91308	A4	37
SMA Female	(P)	PE91064	B4	37
SMA Female	(P)	PE9779	C4	37
SMA Male		PE91312	E7	34
SMA Male	(P)	PE91062	A1	35
SMA Male	(P)	PE9513	B1	35
SMP Female		PE91065	D5	39
SMP Female		PE91065	D5	39
SMP In-Series:				
Female to Female		PE91102	D3	39
Female to Female		PE9776	E3	39
Female to Female		PE91068	A4	39
Female to Female		PE91072	B4	39
Female to Female		PE91099	C4	39
Female to Female		PE91101	D4	39
Female to Female		PE9775	E4	39
Female to Female		PE9777	A5	39
SMP Male To:				
2.4mm Female		PE91048	C3	17
SMA Female	(P) (PM)	PE91057	D3	37
SMA Female	(P) (PM)	PE91059	E3	37
Snap-On MMBX Jack To:				
SMA Female	(SO)	PE91363	C4	36
SMA Male	(SO)	PE91362	E3	34
Snap-On MMBX Plug To:				
Push-On SMP Female	(PO) (SO)	PE91364	C5	39
SMA Female	(SO)	PE91361	B4	36
SMA Male	(SO)	PE91360	D3	34
Snap-On QMA Female To:				
SMA Male	(SO)	PE91346	B1	31
Snap-On SMA Female	(SO)	PE91347	C1	31
Snap-On QMA Male To:				
SMA Female	(SO)	PE91345	A1	31
Snap-On SMA Male	(SO)	PE91344	E7	30
Snap-On SMA Female To:				
Snap-On QMA Female	(SO)	PE91347	C1	31
Snap-On SMA Male To:				
Snap-On QMA Male	(SO)	PE91344	E7	30
SSMA Female To:				
7mm Sexless	(P)	PE9356	A1	40
BNC Male		PE9191	B1	40
N Female		PE9354	D1	40
N Male		PE9352	C1	40
SMA Female		PE9399	E4	37
SMA Male		PE9063	D1	35
SSMA In-Series:				
Female to Female		PE9192	E6	39
Female to Female	(B)	PE9189	A7	39
Male to Female		PE9358	B6	39
Male to Female	(QD)	PE9685	C6	39
Male to Female	90°	PE9334	D6	39
Male to Male		PE9357	A6	39
SSMA Male To:				
2.92mm Female		PE9768	A6	18
BNC Female		PE91046	D7	39
BNC Male		PE9213	C7	39
N Male		PE9351	E7	39
SMA Female		PE9188	D4	37
SMA Male		PE9187	C1	35
SSMB Jack To:				
BNC Female		PE9394	D2	40
BNC Male		PE9392	C2	40
SMA Male		PE9401	E1	35
SSMB Plug To:				
BNC Female		PE9395	B2	40
BNC Male		PE9393	A2	40
SMA Female		PE9402	A5	37
SSMC In-Series:				
Jack to Jack	(B)	PE91432	C3	40
Plug to Jack		PE91434	B3	40
Plug to Plug		PE91436	A3	40
SSMC Jack To:				
SMA Female		PE91433	C5	37
SSMC Plug To:				
SMA Female		PE91380	B5	37
TNC Female To:				
7/16 DIN Female		PE91392	B6	41
7mm Sexless	(P)	PE9218	A6	41
BNC Female		PE9097	D6	41
BNC Male		PE9098	C6	41
C Male		PE9564	E6	41
FME Jack		PE9714	A7	41
Limited Detent SMP Male	(B)	PE91073	A1	42
MCX Jack		PE9544	C7	41
MCX Jack	(B)	PE9521	D7	41
MCX Plug		PE9545	B7	41
Mini UHF Male		PE9346	E7	41
N Female		PE9131	E4	30
N Female	(P)	PE9449	A5	30
N Female	(PM)	PE9552	B5	30
N Female	(B)	PE9482	C5	30
N Female	(P) (PM)	PE9450	D5	30
N Male		PE9090	E3	29
N Male	(P)	PE9448	A4	29
N Male	90°	PE9550	B4	29

Connector Type	Feature	Model No.	C/R	Page
Reverse Polarity SMA Female		PE9599	C2	38
Reverse Polarity SMA Male		PE9596	E1	38
SMA Female		PE9079	A6	37
SMA Female		PE9442	B6	37
SMA Female	(B)	PE9251	C6	37
SMA Female	(PM)	PE9276	D6	37
SMA Male		PE9078	C2	35
SMA Male		PE91507	E2	35
SMA Male	(PM)	PE9384	B3	35
UHF Male		PE9372	B1	42
TNC In-Series:				
Female to Female		PE91204	A7	40
Female to Female		PE91241	B7	40
Female to Female		PE9098	C7	40
Female to Female	(LP)	PE91174	D7	40
Female to Female	(P)	PE9444	E7	40
Female to Female		PE91381	A1	41
Female to Female	(B)	PE9154	B1	41
Female to Female	(PM)	PE9288	C1	41
Female to Female	(B)	PE91205	D1	41
Female to Female	(B)	PE91242	E1	41
Female to Female	(B)	PE9287	A2	41
Female to Male		PE9195	E6	40
Male to Female		PE91203	A5	40
Male to Female		PE91240	B5	40
Male to Female	(P)	PE91505	C5	40
Male to Female	(LP)	PE91173	D5	40
Male to Female		PE9270	E5	40
Male to Female		PE9443	A6	40
Male to Female	(QD)	PE9561	B6	40
Male to Female	90°	PE9100	C6	40
Male to Female		PE9290	D6	40
Male to Male	(LP)	PE91172	E3	40
Male to Male		PE91202	A4	40
Male to Male		PE91239	B4	40
Male to Male		PE9091	C4	40
Male to Male		PE9445	D4	40
Male to Male	90°	PE9560	E4	40
TNC Male To:				
7/16 DIN Female		PE9638	C3	41
7mm Sexless	(P)	PE9219	B3	41
BNC Female		PE9088	D3	41
BNC Female	90°	PE9783	E3	41
C Female		PE9562	A4	41
FME Jack		PE9713	D4	41
FME Plug		PE9699	B4	41
FME Plug	90°	PE9700	C4	41
HN Male		PE9563	E4	41
MCX Jack		PE9542	B5	41
MCX Plug		PE9543	A5	41
Mini UHF Female		PE9345	C5	41
N Female		PE9089	B4	30
N Female	(P)	PE91506	C4	30
N Female	90°	PE9263	D4	30
N Male		PE9130	C3	29
N Male	(P)	PE9446	D3	29
Reverse Polarity SMA Female		PE9598	B2	38
Reverse Polarity SMA Male		PE9597	D1	38
SMA Female		PE9077	D5	37
SMA Female		PE9440	E5	37
SMA Male		PE9076	A2	35
SMA Male		PE9439	B2	35
SMC Jack		PE9226	D5	41
UHF Female		PE9291	E5	41
UHF Female To:				
75 Ohm F Female		PE9167	D4	42
BNC Female		PE9421	C4	42
BNC Male		PE91329	B4	42
Mini UHF Male		PE91447	E4	42
N Female		PE9385	A6	30
N Male		PE9111	D4	29
SMA Male		PE9400	C3	35
TNC Male		PE9291	E5	41
UHF In-Series:				
Female to Female		PE9094	D2	42
Female to Female	(B)	PE9114	E2	42
Female to Male		PE9095	C2	42
Male to Female	90°	PE9209	B2	42
Male to Male		PE91487	A2	42
UHF Male To:				
75 Ohm F Female		PE9165	D3	42
BNC Female		PE91328	C3	42
BNC Male		PE9201	B3	42
FME Plug		PE9701	E3	42
Mini UHF Female		PE9348	A4	42
N Female		PE9112	E5	30
N Male		PE9113	C4	29
SMA Female		PE9415	E6	37
TNC Female				































LOW PIM ADAPTERS

See Adapter Locator on Pages 8-13

See Page 369 for Mounting Holes

Adapters









See Our Website For Current Pricing & Real-Time Stock Availability!

	A	B	C	D	E																																																																											
1	<p>4.1/9.5 Mini DIN Between Series</p>  <table border="1"> <thead> <tr> <th colspan="3">PRICE</th> </tr> </thead> <tbody> <tr> <td>1-24</td> <td></td> <td>\$59.07</td> </tr> <tr> <td>25-49</td> <td></td> <td>\$56.12</td> </tr> <tr> <td>50-99</td> <td></td> <td>\$53.16</td> </tr> <tr> <td>100+</td> <td></td> <td>\$50.80</td> </tr> </tbody> </table> <p>Low PIM</p> <p>4.1/9.5 Mini DIN Male to N Male</p> <p>VSWR 1.25:1 to 6 GHz</p> <p>Model No: PE91092</p>	PRICE			1-24		\$59.07	25-49		\$56.12	50-99		\$53.16	100+		\$50.80	 <table border="1"> <thead> <tr> <th colspan="3">PRICE</th> </tr> </thead> <tbody> <tr> <td>1-24</td> <td></td> <td>\$57.46</td> </tr> <tr> <td>25-49</td> <td></td> <td>\$54.59</td> </tr> <tr> <td>50-99</td> <td></td> <td>\$51.71</td> </tr> <tr> <td>100+</td> <td></td> <td>\$49.42</td> </tr> </tbody> </table> <p>Low PIM</p> <p>4.1/9.5 Mini DIN Male to N Female</p> <p>VSWR 1.25:1 to 6 GHz</p> <p>Model No: PE91093</p>	PRICE			1-24		\$57.46	25-49		\$54.59	50-99		\$51.71	100+		\$49.42	 <table border="1"> <thead> <tr> <th colspan="3">PRICE</th> </tr> </thead> <tbody> <tr> <td>1-24</td> <td></td> <td>\$59.07</td> </tr> <tr> <td>25-49</td> <td></td> <td>\$56.12</td> </tr> <tr> <td>50-99</td> <td></td> <td>\$53.16</td> </tr> <tr> <td>100+</td> <td></td> <td>\$50.80</td> </tr> </tbody> </table> <p>Low PIM</p> <p>4.1/9.5 Mini DIN Female to N Male</p> <p>VSWR 1.25:1 to 6 GHz</p> <p>Model No: PE91094</p>	PRICE			1-24		\$59.07	25-49		\$56.12	50-99		\$53.16	100+		\$50.80	 <table border="1"> <thead> <tr> <th colspan="3">PRICE</th> </tr> </thead> <tbody> <tr> <td>1-24</td> <td></td> <td>\$59.07</td> </tr> <tr> <td>25-49</td> <td></td> <td>\$56.12</td> </tr> <tr> <td>50-99</td> <td></td> <td>\$53.16</td> </tr> <tr> <td>100+</td> <td></td> <td>\$50.80</td> </tr> </tbody> </table> <p>Low PIM</p> <p>4.1/9.5 Mini DIN Female to N Female</p> <p>VSWR 1.25:1 to 6 GHz</p> <p>Model No: PE91095</p>	PRICE			1-24		\$59.07	25-49		\$56.12	50-99		\$53.16	100+		\$50.80																
PRICE																																																																																
1-24		\$59.07																																																																														
25-49		\$56.12																																																																														
50-99		\$53.16																																																																														
100+		\$50.80																																																																														
PRICE																																																																																
1-24		\$57.46																																																																														
25-49		\$54.59																																																																														
50-99		\$51.71																																																																														
100+		\$49.42																																																																														
PRICE																																																																																
1-24		\$59.07																																																																														
25-49		\$56.12																																																																														
50-99		\$53.16																																																																														
100+		\$50.80																																																																														
PRICE																																																																																
1-24		\$59.07																																																																														
25-49		\$56.12																																																																														
50-99		\$53.16																																																																														
100+		\$50.80																																																																														
2	<p>4.3 Non Constant In-Series</p>  <table border="1"> <thead> <tr> <th colspan="3">PRICE</th> </tr> </thead> <tbody> <tr> <td>1-24</td> <td></td> <td>\$35.12</td> </tr> <tr> <td>25-49</td> <td></td> <td>\$33.36</td> </tr> <tr> <td>50-99</td> <td></td> <td>\$31.61</td> </tr> <tr> <td>100+</td> <td>NEW</td> <td>\$30.20</td> </tr> </tbody> </table> <p>Low PIM</p> <p>4.3-10 Male to 4.3-10 Male</p> <p>VSWR 1.25:1 to 6 GHz</p> <p>Model No: PE91466</p>	PRICE			1-24		\$35.12	25-49		\$33.36	50-99		\$31.61	100+	NEW	\$30.20	 <table border="1"> <thead> <tr> <th colspan="3">PRICE</th> </tr> </thead> <tbody> <tr> <td>1-24</td> <td></td> <td>\$80.00</td> </tr> <tr> <td>25-49</td> <td></td> <td>\$76.00</td> </tr> <tr> <td>50-99</td> <td></td> <td>\$72.00</td> </tr> <tr> <td>100+</td> <td>NEW</td> <td>\$68.80</td> </tr> </tbody> </table> <p>Low PIM</p> <p>4.3-10 Male to 4.3-10 Male</p> <p>VSWR 1.08:1 to 6 GHz</p> <p>Model No: PE91385</p>	PRICE			1-24		\$80.00	25-49		\$76.00	50-99		\$72.00	100+	NEW	\$68.80	 <table border="1"> <thead> <tr> <th colspan="3">PRICE</th> </tr> </thead> <tbody> <tr> <td>1-24</td> <td></td> <td>\$39.69</td> </tr> <tr> <td>25-49</td> <td></td> <td>\$37.71</td> </tr> <tr> <td>50-99</td> <td></td> <td>\$35.72</td> </tr> <tr> <td>100+</td> <td>NEW</td> <td>\$34.13</td> </tr> </tbody> </table> <p>Low PIM</p> <p>4.3-10 Male to 4.3-10 Female</p> <p>VSWR 1.25:1 to 6 GHz</p> <p>Model No: PE91465</p>	PRICE			1-24		\$39.69	25-49		\$37.71	50-99		\$35.72	100+	NEW	\$34.13	 <table border="1"> <thead> <tr> <th colspan="3">PRICE</th> </tr> </thead> <tbody> <tr> <td>1-24</td> <td></td> <td>\$80.00</td> </tr> <tr> <td>25-49</td> <td></td> <td>\$76.00</td> </tr> <tr> <td>50-99</td> <td></td> <td>\$72.00</td> </tr> <tr> <td>100+</td> <td>NEW</td> <td>\$68.80</td> </tr> </tbody> </table> <p>Low PIM</p> <p>4.3-10 Male to 4.3-10 Female Right Angle</p> <p>VSWR 1.2:1 to 3 GHz</p> <p>Model No: PE91467</p>	PRICE			1-24		\$80.00	25-49		\$76.00	50-99		\$72.00	100+	NEW	\$68.80																
PRICE																																																																																
1-24		\$35.12																																																																														
25-49		\$33.36																																																																														
50-99		\$31.61																																																																														
100+	NEW	\$30.20																																																																														
PRICE																																																																																
1-24		\$80.00																																																																														
25-49		\$76.00																																																																														
50-99		\$72.00																																																																														
100+	NEW	\$68.80																																																																														
PRICE																																																																																
1-24		\$39.69																																																																														
25-49		\$37.71																																																																														
50-99		\$35.72																																																																														
100+	NEW	\$34.13																																																																														
PRICE																																																																																
1-24		\$80.00																																																																														
25-49		\$76.00																																																																														
50-99		\$72.00																																																																														
100+	NEW	\$68.80																																																																														
3	 <table border="1"> <thead> <tr> <th colspan="3">PRICE</th> </tr> </thead> <tbody> <tr> <td>1-24</td> <td></td> <td>\$81.02</td> </tr> <tr> <td>25-49</td> <td></td> <td>\$77.78</td> </tr> <tr> <td>50-99</td> <td></td> <td>\$75.35</td> </tr> <tr> <td>100+</td> <td></td> <td>\$73.73</td> </tr> </tbody> </table> <p>Low PIM</p> <p>4.3-10 Male to 4.3-10 Female</p> <p>VSWR 1.08:1 to 6 GHz</p> <p>Model No: PE91387</p>	PRICE			1-24		\$81.02	25-49		\$77.78	50-99		\$75.35	100+		\$73.73	 <table border="1"> <thead> <tr> <th colspan="3">PRICE</th> </tr> </thead> <tbody> <tr> <td>1-24</td> <td></td> <td>\$39.69</td> </tr> <tr> <td>25-49</td> <td></td> <td>\$37.71</td> </tr> <tr> <td>50-99</td> <td></td> <td>\$35.72</td> </tr> <tr> <td>100+</td> <td>NEW</td> <td>\$34.13</td> </tr> </tbody> </table> <p>Low PIM</p> <p>4.3-10 Female to 4.3-10 Female</p> <p>VSWR 1.25:1 to 6 GHz</p> <p>Model No: PE91464</p>	PRICE			1-24		\$39.69	25-49		\$37.71	50-99		\$35.72	100+	NEW	\$34.13	 <table border="1"> <thead> <tr> <th colspan="3">PRICE</th> </tr> </thead> <tbody> <tr> <td>1-24</td> <td></td> <td>\$82.65</td> </tr> <tr> <td>25-49</td> <td></td> <td>\$78.52</td> </tr> <tr> <td>50-99</td> <td></td> <td>\$74.39</td> </tr> <tr> <td>100+</td> <td>NEW</td> <td>\$71.08</td> </tr> </tbody> </table> <p>Low PIM</p> <p>4.3-10 Female to 4.3-10 Female</p> <p>VSWR 1.08:1 to 6 GHz</p> <p>Model No: PE91386</p>	PRICE			1-24		\$82.65	25-49		\$78.52	50-99		\$74.39	100+	NEW	\$71.08	<p>4.3 Non Constant Between Series</p>  <table border="1"> <thead> <tr> <th colspan="3">PRICE</th> </tr> </thead> <tbody> <tr> <td>1-24</td> <td></td> <td>\$35.12</td> </tr> <tr> <td>25-49</td> <td></td> <td>\$33.36</td> </tr> <tr> <td>50-99</td> <td></td> <td>\$31.61</td> </tr> <tr> <td>100+</td> <td>NEW</td> <td>\$30.20</td> </tr> </tbody> </table> <p>Low PIM</p> <p>4.3-10 Male to N Male</p> <p>VSWR 1.25:1 to 6 GHz</p> <p>Model No: PE91476</p>	PRICE			1-24		\$35.12	25-49		\$33.36	50-99		\$31.61	100+	NEW	\$30.20																
PRICE																																																																																
1-24		\$81.02																																																																														
25-49		\$77.78																																																																														
50-99		\$75.35																																																																														
100+		\$73.73																																																																														
PRICE																																																																																
1-24		\$39.69																																																																														
25-49		\$37.71																																																																														
50-99		\$35.72																																																																														
100+	NEW	\$34.13																																																																														
PRICE																																																																																
1-24		\$82.65																																																																														
25-49		\$78.52																																																																														
50-99		\$74.39																																																																														
100+	NEW	\$71.08																																																																														
PRICE																																																																																
1-24		\$35.12																																																																														
25-49		\$33.36																																																																														
50-99		\$31.61																																																																														
100+	NEW	\$30.20																																																																														
4	 <table border="1"> <thead> <tr> <th colspan="3">PRICE</th> </tr> </thead> <tbody> <tr> <td>1-24</td> <td></td> <td>\$48.00</td> </tr> <tr> <td>25-49</td> <td></td> <td>\$45.60</td> </tr> <tr> <td>50-99</td> <td></td> <td>\$43.20</td> </tr> <tr> <td>100+</td> <td>NEW</td> <td>\$41.28</td> </tr> </tbody> </table> <p>Low PIM</p> <p>QD 4.3-10 Male to N Male</p> <p>VSWR 1.25:1 to 6 GHz</p> <p>Model No: PE91480</p>	PRICE			1-24		\$48.00	25-49		\$45.60	50-99		\$43.20	100+	NEW	\$41.28	 <table border="1"> <thead> <tr> <th colspan="3">PRICE</th> </tr> </thead> <tbody> <tr> <td>1-24</td> <td></td> <td>\$35.12</td> </tr> <tr> <td>25-49</td> <td></td> <td>\$33.36</td> </tr> <tr> <td>50-99</td> <td></td> <td>\$31.61</td> </tr> <tr> <td>100+</td> <td>NEW</td> <td>\$30.20</td> </tr> </tbody> </table> <p>Low PIM</p> <p>4.3-10 Male to N Female</p> <p>VSWR 1.25:1 to 6 GHz</p> <p>Model No: PE91474</p>	PRICE			1-24		\$35.12	25-49		\$33.36	50-99		\$31.61	100+	NEW	\$30.20	 <table border="1"> <thead> <tr> <th colspan="3">PRICE</th> </tr> </thead> <tbody> <tr> <td>1-24</td> <td></td> <td>\$35.12</td> </tr> <tr> <td>25-49</td> <td></td> <td>\$33.36</td> </tr> <tr> <td>50-99</td> <td></td> <td>\$31.61</td> </tr> <tr> <td>100+</td> <td>NEW</td> <td>\$30.20</td> </tr> </tbody> </table> <p>Low PIM</p> <p>4.3-10 Male to N Female</p> <p>VSWR 1.25:1 to 6 GHz</p> <p>Model No: PE91477</p>	PRICE			1-24		\$35.12	25-49		\$33.36	50-99		\$31.61	100+	NEW	\$30.20	 <table border="1"> <thead> <tr> <th colspan="3">PRICE</th> </tr> </thead> <tbody> <tr> <td>1-24</td> <td></td> <td>\$46.20</td> </tr> <tr> <td>25-49</td> <td></td> <td>\$43.89</td> </tr> <tr> <td>50-99</td> <td></td> <td>\$41.58</td> </tr> <tr> <td>100+</td> <td>NEW</td> <td>\$39.73</td> </tr> </tbody> </table> <p>Low PIM</p> <p>QD 4.3-10 Male to N Female</p> <p>VSWR 1.25:1 to 6 GHz</p> <p>Model No: PE91478</p>	PRICE			1-24		\$46.20	25-49		\$43.89	50-99		\$41.58	100+	NEW	\$39.73	 <table border="1"> <thead> <tr> <th colspan="3">PRICE</th> </tr> </thead> <tbody> <tr> <td>1-24</td> <td></td> <td>\$56.45</td> </tr> <tr> <td>25-49</td> <td></td> <td>\$53.63</td> </tr> <tr> <td>50-99</td> <td></td> <td>\$50.81</td> </tr> <tr> <td>100+</td> <td>NEW</td> <td>\$48.55</td> </tr> </tbody> </table> <p>Low PIM</p> <p>4.3-10 Male to N Female Right Angle</p> <p>VSWR 1.25:1 to 6 GHz</p> <p>Model No: PE91483</p>	PRICE			1-24		\$56.45	25-49		\$53.63	50-99		\$50.81	100+	NEW	\$48.55
PRICE																																																																																
1-24		\$48.00																																																																														
25-49		\$45.60																																																																														
50-99		\$43.20																																																																														
100+	NEW	\$41.28																																																																														
PRICE																																																																																
1-24		\$35.12																																																																														
25-49		\$33.36																																																																														
50-99		\$31.61																																																																														
100+	NEW	\$30.20																																																																														
PRICE																																																																																
1-24		\$35.12																																																																														
25-49		\$33.36																																																																														
50-99		\$31.61																																																																														
100+	NEW	\$30.20																																																																														
PRICE																																																																																
1-24		\$46.20																																																																														
25-49		\$43.89																																																																														
50-99		\$41.58																																																																														
100+	NEW	\$39.73																																																																														
PRICE																																																																																
1-24		\$56.45																																																																														
25-49		\$53.63																																																																														
50-99		\$50.81																																																																														
100+	NEW	\$48.55																																																																														
5	 <table border="1"> <thead> <tr> <th colspan="3">PRICE</th> </tr> </thead> <tbody> <tr> <td>1-24</td> <td></td> <td>\$84.23</td> </tr> <tr> <td>25-49</td> <td></td> <td>\$80.02</td> </tr> <tr> <td>50-99</td> <td></td> <td>\$75.81</td> </tr> <tr> <td>100+</td> <td>NEW</td> <td>\$72.44</td> </tr> </tbody> </table> <p>Low PIM</p> <p>4.3-10 Male to N Female</p> <p>VSWR 1.08:1 to 6 GHz</p> <p>Model No: PE91389</p>	PRICE			1-24		\$84.23	25-49		\$80.02	50-99		\$75.81	100+	NEW	\$72.44	 <table border="1"> <thead> <tr> <th colspan="3">PRICE</th> </tr> </thead> <tbody> <tr> <td>1-24</td> <td></td> <td>\$34.63</td> </tr> <tr> <td>25-49</td> <td></td> <td>\$32.90</td> </tr> <tr> <td>50-99</td> <td></td> <td>\$31.17</td> </tr> <tr> <td>100+</td> <td>NEW</td> <td>\$29.78</td> </tr> </tbody> </table> <p>Low PIM</p> <p>4.3-10 Male to SMA Female</p> <p>VSWR 1.15:1 to 6 GHz</p> <p>Model No: PE91484</p>	PRICE			1-24		\$34.63	25-49		\$32.90	50-99		\$31.17	100+	NEW	\$29.78	 <table border="1"> <thead> <tr> <th colspan="3">PRICE</th> </tr> </thead> <tbody> <tr> <td>1-24</td> <td></td> <td>\$41.28</td> </tr> <tr> <td>25-49</td> <td></td> <td>\$39.22</td> </tr> <tr> <td>50-99</td> <td></td> <td>\$37.15</td> </tr> <tr> <td>100+</td> <td>NEW</td> <td>\$35.50</td> </tr> </tbody> </table> <p>Low PIM</p> <p>4.3-10 Female to N Male</p> <p>VSWR 1.25:1 to 6 GHz</p> <p>Model No: PE91479</p>	PRICE			1-24		\$41.28	25-49		\$39.22	50-99		\$37.15	100+	NEW	\$35.50	 <table border="1"> <thead> <tr> <th colspan="3">PRICE</th> </tr> </thead> <tbody> <tr> <td>1-24</td> <td></td> <td>\$38.93</td> </tr> <tr> <td>25-49</td> <td></td> <td>\$36.98</td> </tr> <tr> <td>50-99</td> <td></td> <td>\$35.04</td> </tr> <tr> <td>100+</td> <td>NEW</td> <td>\$33.48</td> </tr> </tbody> </table> <p>Low PIM</p> <p>QD 4.3-10 Female to N Male</p> <p>VSWR 1.25:1 to 6 GHz</p> <p>Model No: PE91481</p>	PRICE			1-24		\$38.93	25-49		\$36.98	50-99		\$35.04	100+	NEW	\$33.48	 <table border="1"> <thead> <tr> <th colspan="3">PRICE</th> </tr> </thead> <tbody> <tr> <td>1-24</td> <td></td> <td>\$35.88</td> </tr> <tr> <td>25-49</td> <td></td> <td>\$34.09</td> </tr> <tr> <td>50-99</td> <td></td> <td>\$32.29</td> </tr> <tr> <td>100+</td> <td>NEW</td> <td>\$30.86</td> </tr> </tbody> </table> <p>Low PIM</p> <p>4.3-10 Female to N Female</p> <p>VSWR 1.25:1 to 6 GHz</p> <p>Model No: PE91475</p>	PRICE			1-24		\$35.88	25-49		\$34.09	50-99		\$32.29	100+	NEW	\$30.86
PRICE																																																																																
1-24		\$84.23																																																																														
25-49		\$80.02																																																																														
50-99		\$75.81																																																																														
100+	NEW	\$72.44																																																																														
PRICE																																																																																
1-24		\$34.63																																																																														
25-49		\$32.90																																																																														
50-99		\$31.17																																																																														
100+	NEW	\$29.78																																																																														
PRICE																																																																																
1-24		\$41.28																																																																														
25-49		\$39.22																																																																														
50-99		\$37.15																																																																														
100+	NEW	\$35.50																																																																														
PRICE																																																																																
1-24		\$38.93																																																																														
25-49		\$36.98																																																																														
50-99		\$35.04																																																																														
100+	NEW	\$33.48																																																																														
PRICE																																																																																
1-24		\$35.88																																																																														
25-49		\$34.09																																																																														
50-99		\$32.29																																																																														
100+	NEW	\$30.86																																																																														
6	 <table border="1"> <thead> <tr> <th colspan="3">PRICE</th> </tr> </thead> <tbody> <tr> <td>1-24</td> <td></td> <td>\$38.72</td> </tr> <tr> <td>25-49</td> <td></td> <td>\$36.78</td> </tr> <tr> <td>50-99</td> <td></td> <td>\$34.85</td> </tr> <tr> <td>100+</td> <td>NEW</td> <td>\$33.30</td> </tr> </tbody> </table> <p>Low PIM</p> <p>QD 4.3-10 Female to N Female</p> <p>VSWR 1.25:1 to 6 GHz</p> <p>Model No: PE91482</p>	PRICE			1-24		\$38.72	25-49		\$36.78	50-99		\$34.85	100+	NEW	\$33.30	<p>7/16 DIN In-Series</p>  <table border="1"> <thead> <tr> <th colspan="3">PRICE</th> </tr> </thead> <tbody> <tr> <td>1-9</td> <td></td> <td>\$114.26</td> </tr> <tr> <td>10-24</td> <td></td> <td>\$108.55</td> </tr> <tr> <td>25-49</td> <td></td> <td>\$102.83</td> </tr> <tr> <td>50+</td> <td></td> <td>\$98.26</td> </tr> </tbody> </table> <p>Low PIM</p> <p>7/16 DIN Male to 7/16 DIN Male</p> <p>Max. Freq. 8 GHz</p> <p>Model No: PE91039</p>	PRICE			1-9		\$114.26	10-24		\$108.55	25-49		\$102.83	50+		\$98.26	 <table border="1"> <thead> <tr> <th colspan="3">PRICE</th> </tr> </thead> <tbody> <tr> <td>1-9</td> <td></td> <td>\$108.84</td> </tr> <tr> <td>10-24</td> <td></td> <td>\$103.40</td> </tr> <tr> <td>25-49</td> <td></td> <td>\$97.96</td> </tr> <tr> <td>50+</td> <td></td> <td>\$93.60</td> </tr> </tbody> </table> <p>Low PIM</p> <p>7/16 DIN Male to 7/16 DIN Female</p> <p>Max. Freq. 8 GHz</p> <p>Model No: PE91028</p>	PRICE			1-9		\$108.84	10-24		\$103.40	25-49		\$97.96	50+		\$93.60	 <table border="1"> <thead> <tr> <th colspan="3">PRICE</th> </tr> </thead> <tbody> <tr> <td>1-9</td> <td></td> <td>\$108.84</td> </tr> <tr> <td>10-24</td> <td></td> <td>\$103.40</td> </tr> <tr> <td>25-49</td> <td></td> <td>\$97.96</td> </tr> <tr> <td>50+</td> <td></td> <td>\$93.60</td> </tr> </tbody> </table> <p>Low PIM</p> <p>7/16 DIN Female to 7/16 DIN Female</p> <p>Max. Freq. 8 GHz</p> <p>Model No: PE91029</p>	PRICE			1-9		\$108.84	10-24		\$103.40	25-49		\$97.96	50+		\$93.60																
PRICE																																																																																
1-24		\$38.72																																																																														
25-49		\$36.78																																																																														
50-99		\$34.85																																																																														
100+	NEW	\$33.30																																																																														
PRICE																																																																																
1-9		\$114.26																																																																														
10-24		\$108.55																																																																														
25-49		\$102.83																																																																														
50+		\$98.26																																																																														
PRICE																																																																																
1-9		\$108.84																																																																														
10-24		\$103.40																																																																														
25-49		\$97.96																																																																														
50+		\$93.60																																																																														
PRICE																																																																																
1-9		\$108.84																																																																														
10-24		\$103.40																																																																														
25-49		\$97.96																																																																														
50+		\$93.60																																																																														
7	 <table border="1"> <thead> <tr> <th colspan="3">PRICE</th> </tr> </thead> <tbody> <tr> <td>1-9</td> <td></td> <td>\$142.97</td> </tr> <tr> <td>10-24</td> <td></td> <td>\$135.82</td> </tr> <tr> <td>25-49</td> <td></td> <td>\$128.67</td> </tr> <tr> <td>50+</td> <td></td> <td>\$122.95</td> </tr> </tbody> </table> <p>Low PIM</p> <p>7/16 DIN Female to 7/16 DIN Female Bulkhead</p> <p>Max. Freq. 8 GHz</p> <p>Model No: PE91038</p>	PRICE			1-9		\$142.97	10-24		\$135.82	25-49		\$128.67	50+		\$122.95	<p>7/16 DIN Between Series</p>  <table border="1"> <thead> <tr> <th colspan="3">PRICE</th> </tr> </thead> <tbody> <tr> <td>1-24</td> <td></td> <td>\$77.31</td> </tr> <tr> <td>25-49</td> <td></td> <td>\$73.44</td> </tr> <tr> <td>50-99</td> <td></td> <td>\$69.58</td> </tr> <tr> <td>100+</td> <td></td> <td>\$66.49</td> </tr> </tbody> </table> <p>Low PIM</p> <p>7/16 DIN Male to 4.1/9.5 Mini DIN Male</p> <p>VSWR 1.25:1 to 6 GHz</p> <p>Model No: PE91088</p>	PRICE			1-24		\$77.31	25-49		\$73.44	50-99		\$69.58	100+		\$66.49	 <table border="1"> <thead> <tr> <th colspan="3">PRICE</th> </tr> </thead> <tbody> <tr> <td>1-24</td> <td></td> <td>\$83.50</td> </tr> <tr> <td>25-49</td> <td></td> <td>\$79.33</td> </tr> <tr> <td>50-99</td> <td></td> <td>\$75.15</td> </tr> <tr> <td>100+</td> <td></td> <td>\$71.81</td> </tr> </tbody> </table> <p>Low PIM</p> <p>7/16 DIN Male to 4.1/9.5 Mini DIN Female</p> <p>VSWR 1.25:1 to 6 GHz</p> <p>Model No: PE91089</p>	PRICE			1-24		\$83.50	25-49		\$79.33	50-99		\$75.15	100+		\$71.81	 <table border="1"> <thead> <tr> <th colspan="3">PRICE</th> </tr> </thead> <tbody> <tr> <td>1-24</td> <td></td> <td>\$36.65</td> </tr> <tr> <td>25-49</td> <td></td> <td>\$34.82</td> </tr> <tr> <td>50-99</td> <td></td> <td>\$32.99</td> </tr> <tr> <td>100+</td> <td>NEW</td> <td>\$31.52</td> </tr> </tbody> </table> <p>Low PIM</p> <p>7/16 DIN Male to 4.3-10 Male</p> <p>VSWR 1.25:1 to 6 GHz</p> <p>Model No: PE91468</p>	PRICE			1-24		\$36.65	25-49		\$34.82	50-99		\$32.99	100+	NEW	\$31.52																
PRICE																																																																																
1-9		\$142.97																																																																														
10-24		\$135.82																																																																														
25-49		\$128.67																																																																														
50+		\$122.95																																																																														
PRICE																																																																																
1-24		\$77.31																																																																														
25-49		\$73.44																																																																														
50-99		\$69.58																																																																														
100+		\$66.49																																																																														
PRICE																																																																																
1-24		\$83.50																																																																														
25-49		\$79.33																																																																														
50-99		\$75.15																																																																														
100+		\$71.81																																																																														
PRICE																																																																																
1-24		\$36.65																																																																														
25-49		\$34.82																																																																														
50-99		\$32.99																																																																														
100+	NEW	\$31.52																																																																														

LOW PIM ADAPTERS

See Adapter Locator on Pages 8-13

See Page 369 for Mounting Holes

	A	B	C	D	E																																													
1	 <table border="1"> <thead> <tr><th>PRICE</th></tr> </thead> <tbody> <tr><td>1-24</td><td>\$39.69</td></tr> <tr><td>25-49</td><td>\$37.71</td></tr> <tr><td>50-99</td><td>\$35.72</td></tr> <tr><td>100+</td><td>\$34.13</td></tr> </tbody> </table> <p>Low PIM NEW 100+</p> <p>7/16 DIN Male to 4.3-10 Female</p> <p>VSWR 1.25:1 to 6 GHz</p> <p>Model No: PE91469</p>	PRICE	1-24	\$39.69	25-49	\$37.71	50-99	\$35.72	100+	\$34.13	 <table border="1"> <thead> <tr><th>PRICE</th></tr> </thead> <tbody> <tr><td>1-24</td><td>\$69.15</td></tr> <tr><td>25-49</td><td>\$65.69</td></tr> <tr><td>50-99</td><td>\$62.24</td></tr> <tr><td>100+</td><td>\$59.47</td></tr> </tbody> </table> <p>Low PIM NEW 100+</p> <p>7/16 DIN Male to 4.3-10 Female</p> <p>VSWR 1.08:1 to 6 GHz</p> <p>Model No: PE91390</p>	PRICE	1-24	\$69.15	25-49	\$65.69	50-99	\$62.24	100+	\$59.47	 <table border="1"> <thead> <tr><th>PRICE</th></tr> </thead> <tbody> <tr><td>1-24</td><td>\$77.31</td></tr> <tr><td>25-49</td><td>\$73.44</td></tr> <tr><td>50-99</td><td>\$69.58</td></tr> <tr><td>100+</td><td>\$66.49</td></tr> </tbody> </table> <p>Low PIM 100+</p> <p>7/16 DIN Female to 4.1/9.5 Mini DIN Male</p> <p>VSWR 1.25:1 to 6 GHz</p> <p>Model No: PE91090</p>	PRICE	1-24	\$77.31	25-49	\$73.44	50-99	\$69.58	100+	\$66.49	 <table border="1"> <thead> <tr><th>PRICE</th></tr> </thead> <tbody> <tr><td>1-24</td><td>\$77.31</td></tr> <tr><td>25-49</td><td>\$73.44</td></tr> <tr><td>50-99</td><td>\$69.58</td></tr> <tr><td>100+</td><td>\$66.49</td></tr> </tbody> </table> <p>Low PIM 100+</p> <p>7/16 DIN Female to 4.1/9.5 Mini DIN Female</p> <p>VSWR 1.25:1 to 6 GHz</p> <p>Model No: PE91091</p>	PRICE	1-24	\$77.31	25-49	\$73.44	50-99	\$69.58	100+	\$66.49	 <table border="1"> <thead> <tr><th>PRICE</th></tr> </thead> <tbody> <tr><td>1-24</td><td>\$38.93</td></tr> <tr><td>25-49</td><td>\$36.98</td></tr> <tr><td>50-99</td><td>\$35.04</td></tr> <tr><td>100+</td><td>\$33.48</td></tr> </tbody> </table> <p>Low PIM NEW 100+</p> <p>7/16 DIN Female to 4.3-10 Male</p> <p>VSWR 1.2:1 to 6 GHz</p> <p>Model No: PE91470</p>	PRICE	1-24	\$38.93	25-49	\$36.98	50-99	\$35.04	100+	\$33.48
	PRICE																																																	
1-24	\$39.69																																																	
25-49	\$37.71																																																	
50-99	\$35.72																																																	
100+	\$34.13																																																	
PRICE																																																		
1-24	\$69.15																																																	
25-49	\$65.69																																																	
50-99	\$62.24																																																	
100+	\$59.47																																																	
PRICE																																																		
1-24	\$77.31																																																	
25-49	\$73.44																																																	
50-99	\$69.58																																																	
100+	\$66.49																																																	
PRICE																																																		
1-24	\$77.31																																																	
25-49	\$73.44																																																	
50-99	\$69.58																																																	
100+	\$66.49																																																	
PRICE																																																		
1-24	\$38.93																																																	
25-49	\$36.98																																																	
50-99	\$35.04																																																	
100+	\$33.48																																																	
2	 <table border="1"> <thead> <tr><th>PRICE</th></tr> </thead> <tbody> <tr><td>1-24</td><td>\$55.13</td></tr> <tr><td>25-49</td><td>\$52.37</td></tr> <tr><td>50-99</td><td>\$49.61</td></tr> <tr><td>100+</td><td>\$47.42</td></tr> </tbody> </table> <p>Low PIM NEW 100+</p> <p>7/16 DIN Female to QD 4.3-10 Male</p> <p>VSWR 1.2:1 to 6 GHz</p> <p>Model No: PE91472</p>	PRICE	1-24	\$55.13	25-49	\$52.37	50-99	\$49.61	100+	\$47.42	 <table border="1"> <thead> <tr><th>PRICE</th></tr> </thead> <tbody> <tr><td>1-9</td><td>\$112.70</td></tr> <tr><td>10-24</td><td>\$107.07</td></tr> <tr><td>25-49</td><td>\$101.43</td></tr> <tr><td>50+</td><td>\$96.92</td></tr> </tbody> </table> <p>Low PIM NEW 50+</p> <p>7/16 DIN Female to 4.3-10 Male</p> <p>VSWR 1.08:1 to 6 GHz</p> <p>Model No: PE91391</p>	PRICE	1-9	\$112.70	10-24	\$107.07	25-49	\$101.43	50+	\$96.92	 <table border="1"> <thead> <tr><th>PRICE</th></tr> </thead> <tbody> <tr><td>1-24</td><td>\$39.69</td></tr> <tr><td>25-49</td><td>\$37.71</td></tr> <tr><td>50-99</td><td>\$35.72</td></tr> <tr><td>100+</td><td>\$34.13</td></tr> </tbody> </table> <p>Low PIM NEW 100+</p> <p>7/16 DIN Female to 4.3-10 Female</p> <p>VSWR 1.25:1 to 6 GHz</p> <p>Model No: PE91471</p>	PRICE	1-24	\$39.69	25-49	\$37.71	50-99	\$35.72	100+	\$34.13	 <table border="1"> <thead> <tr><th>PRICE</th></tr> </thead> <tbody> <tr><td>1-24</td><td>\$40.53</td></tr> <tr><td>25-49</td><td>\$38.50</td></tr> <tr><td>50-99</td><td>\$36.48</td></tr> <tr><td>100+</td><td>\$34.86</td></tr> </tbody> </table> <p>Low PIM NEW 100+</p> <p>7/16 DIN Female to QD 4.3-10 Female</p> <p>VSWR 1.2:1 to 6 GHz</p> <p>Model No: PE91473</p>	PRICE	1-24	\$40.53	25-49	\$38.50	50-99	\$36.48	100+	\$34.86	<p>N</p> <p><i>In-Series</i></p> <p>→</p>									
	PRICE																																																	
1-24	\$55.13																																																	
25-49	\$52.37																																																	
50-99	\$49.61																																																	
100+	\$47.42																																																	
PRICE																																																		
1-9	\$112.70																																																	
10-24	\$107.07																																																	
25-49	\$101.43																																																	
50+	\$96.92																																																	
PRICE																																																		
1-24	\$39.69																																																	
25-49	\$37.71																																																	
50-99	\$35.72																																																	
100+	\$34.13																																																	
PRICE																																																		
1-24	\$40.53																																																	
25-49	\$38.50																																																	
50-99	\$36.48																																																	
100+	\$34.86																																																	
3	 <table border="1"> <thead> <tr><th>PRICE</th></tr> </thead> <tbody> <tr><td>1-24</td><td>\$94.34</td></tr> <tr><td>25-49</td><td>\$89.62</td></tr> <tr><td>50-99</td><td>\$84.91</td></tr> <tr><td>100+</td><td>\$81.13</td></tr> </tbody> </table> <p>Low PIM 100+</p> <p>N Male to N Male</p> <p>Max. Freq. 12.4 GHz</p> <p>Model No: PE91034</p>	PRICE	1-24	\$94.34	25-49	\$89.62	50-99	\$84.91	100+	\$81.13	 <table border="1"> <thead> <tr><th>PRICE</th></tr> </thead> <tbody> <tr><td>1-24</td><td>\$98.25</td></tr> <tr><td>25-49</td><td>\$93.34</td></tr> <tr><td>50-99</td><td>\$88.43</td></tr> <tr><td>100+</td><td>\$84.50</td></tr> </tbody> </table> <p>Low PIM 100+</p> <p>N Male to N Female</p> <p>Max. Freq. 12.4 GHz</p> <p>Model No: PE91040</p>	PRICE	1-24	\$98.25	25-49	\$93.34	50-99	\$88.43	100+	\$84.50	 <table border="1"> <thead> <tr><th>PRICE</th></tr> </thead> <tbody> <tr><td>1-24</td><td>\$71.22</td></tr> <tr><td>25-49</td><td>\$67.66</td></tr> <tr><td>50-99</td><td>\$64.10</td></tr> <tr><td>100+</td><td>\$61.25</td></tr> </tbody> </table> <p>Low PIM 100+</p> <p>N Female to N Female</p> <p>VSWR 1.2:1 to 6 GHz</p> <p>Model No: PE91140</p>	PRICE	1-24	\$71.22	25-49	\$67.66	50-99	\$64.10	100+	\$61.25	 <table border="1"> <thead> <tr><th>PRICE</th></tr> </thead> <tbody> <tr><td>1-24</td><td>\$63.79</td></tr> <tr><td>25-49</td><td>\$60.60</td></tr> <tr><td>50-99</td><td>\$57.41</td></tr> <tr><td>100+</td><td>\$54.86</td></tr> </tbody> </table> <p>Low PIM 100+</p> <p>N Female to N Female Bulkhead</p> <p>VSWR 1.2:1 to 6 GHz</p> <p>Model No: PE91179</p>	PRICE	1-24	\$63.79	25-49	\$60.60	50-99	\$57.41	100+	\$54.86	<p>N</p> <p><i>Between Series</i></p> <p>→</p>									
	PRICE																																																	
1-24	\$94.34																																																	
25-49	\$89.62																																																	
50-99	\$84.91																																																	
100+	\$81.13																																																	
PRICE																																																		
1-24	\$98.25																																																	
25-49	\$93.34																																																	
50-99	\$88.43																																																	
100+	\$84.50																																																	
PRICE																																																		
1-24	\$71.22																																																	
25-49	\$67.66																																																	
50-99	\$64.10																																																	
100+	\$61.25																																																	
PRICE																																																		
1-24	\$63.79																																																	
25-49	\$60.60																																																	
50-99	\$57.41																																																	
100+	\$54.86																																																	
4	 <table border="1"> <thead> <tr><th>PRICE</th></tr> </thead> <tbody> <tr><td>1-24</td><td>\$73.94</td></tr> <tr><td>25-49</td><td>\$70.24</td></tr> <tr><td>50-99</td><td>\$66.55</td></tr> <tr><td>100+</td><td>\$63.59</td></tr> </tbody> </table> <p>Low PIM NEW 100+</p> <p>N Male to 4.3-10 Female</p> <p>VSWR 1.08:1 to 6 GHz</p> <p>Model No: PE91388</p>	PRICE	1-24	\$73.94	25-49	\$70.24	50-99	\$66.55	100+	\$63.59	 <table border="1"> <thead> <tr><th>PRICE</th></tr> </thead> <tbody> <tr><td>1-24</td><td>\$91.69</td></tr> <tr><td>25-49</td><td>\$87.11</td></tr> <tr><td>50-99</td><td>\$82.52</td></tr> <tr><td>100+</td><td>\$78.85</td></tr> </tbody> </table> <p>Low PIM 100+</p> <p>N Male to 7/16 DIN Male</p> <p>Max. Freq. 8 GHz</p> <p>Model No: PE91030</p>	PRICE	1-24	\$91.69	25-49	\$87.11	50-99	\$82.52	100+	\$78.85	 <table border="1"> <thead> <tr><th>PRICE</th></tr> </thead> <tbody> <tr><td>1-24</td><td>\$98.25</td></tr> <tr><td>25-49</td><td>\$93.34</td></tr> <tr><td>50-99</td><td>\$88.43</td></tr> <tr><td>100+</td><td>\$84.50</td></tr> </tbody> </table> <p>Low PIM 100+</p> <p>N Male to 7/16 DIN Female</p> <p>Max. Freq. 8 GHz</p> <p>Model No: PE91032</p>	PRICE	1-24	\$98.25	25-49	\$93.34	50-99	\$88.43	100+	\$84.50	 <table border="1"> <thead> <tr><th>PRICE</th></tr> </thead> <tbody> <tr><td>1-24</td><td>\$51.36</td></tr> <tr><td>25-49</td><td>\$48.79</td></tr> <tr><td>50-99</td><td>\$46.22</td></tr> <tr><td>100+</td><td>\$44.17</td></tr> </tbody> </table> <p>Low PIM 100+</p> <p>N Male to SMA Female</p> <p>VSWR 1.2:1 to 6 GHz</p> <p>Model No: PE91177</p>	PRICE	1-24	\$51.36	25-49	\$48.79	50-99	\$46.22	100+	\$44.17	 <table border="1"> <thead> <tr><th>PRICE</th></tr> </thead> <tbody> <tr><td>1-24</td><td>\$96.37</td></tr> <tr><td>25-49</td><td>\$91.55</td></tr> <tr><td>50-99</td><td>\$86.73</td></tr> <tr><td>100+</td><td>\$82.88</td></tr> </tbody> </table> <p>Low PIM 100+</p> <p>N Female to 7/16 DIN Male</p> <p>Max. Freq. 8 GHz</p> <p>Model No: PE91031</p>	PRICE	1-24	\$96.37	25-49	\$91.55	50-99	\$86.73	100+	\$82.88
	PRICE																																																	
1-24	\$73.94																																																	
25-49	\$70.24																																																	
50-99	\$66.55																																																	
100+	\$63.59																																																	
PRICE																																																		
1-24	\$91.69																																																	
25-49	\$87.11																																																	
50-99	\$82.52																																																	
100+	\$78.85																																																	
PRICE																																																		
1-24	\$98.25																																																	
25-49	\$93.34																																																	
50-99	\$88.43																																																	
100+	\$84.50																																																	
PRICE																																																		
1-24	\$51.36																																																	
25-49	\$48.79																																																	
50-99	\$46.22																																																	
100+	\$44.17																																																	
PRICE																																																		
1-24	\$96.37																																																	
25-49	\$91.55																																																	
50-99	\$86.73																																																	
100+	\$82.88																																																	
5	 <table border="1"> <thead> <tr><th>PRICE</th></tr> </thead> <tbody> <tr><td>1-24</td><td>\$98.25</td></tr> <tr><td>25-49</td><td>\$93.34</td></tr> <tr><td>50-99</td><td>\$88.43</td></tr> <tr><td>100+</td><td>\$84.50</td></tr> </tbody> </table> <p>Low PIM 100+</p> <p>N Female to 7/16 DIN Female</p> <p>Max. Freq. 8 GHz</p> <p>Model No: PE91033</p>	PRICE	1-24	\$98.25	25-49	\$93.34	50-99	\$88.43	100+	\$84.50	 <table border="1"> <thead> <tr><th>PRICE</th></tr> </thead> <tbody> <tr><td>1-9</td><td>\$141.81</td></tr> <tr><td>10-24</td><td>\$134.72</td></tr> <tr><td>25-49</td><td>\$127.63</td></tr> <tr><td>50+</td><td>\$121.96</td></tr> </tbody> </table> <p>Low PIM 50+</p> <p>N Female to 7/16 DIN Female</p> <p>Max. Freq. 8 GHz</p> <p>Model No: PE9180</p>	PRICE	1-9	\$141.81	10-24	\$134.72	25-49	\$127.63	50+	\$121.96	 <table border="1"> <thead> <tr><th>PRICE</th></tr> </thead> <tbody> <tr><td>1-24</td><td>\$52.30</td></tr> <tr><td>25-49</td><td>\$49.69</td></tr> <tr><td>50-99</td><td>\$47.07</td></tr> <tr><td>100+</td><td>\$44.98</td></tr> </tbody> </table> <p>Low PIM 100+</p> <p>N Female to SMA Male</p> <p>VSWR 1.2:1 to 6 GHz</p> <p>Model No: PE91178</p>	PRICE	1-24	\$52.30	25-49	\$49.69	50-99	\$47.07	100+	\$44.98	<p>SMA</p> <p><i>Between Series</i></p> <p>→</p>	 <table border="1"> <thead> <tr><th>PRICE</th></tr> </thead> <tbody> <tr><td>1-9</td><td>\$119.52</td></tr> <tr><td>10-24</td><td>\$113.54</td></tr> <tr><td>25-49</td><td>\$107.57</td></tr> <tr><td>50+</td><td>\$102.79</td></tr> </tbody> </table> <p>Low PIM 50+</p> <p>SMA Male to 7/16 DIN Male</p> <p>VSWR 1.09:1 to 7.5 GHz</p> <p>Model No: PE91043</p>	PRICE	1-9	\$119.52	10-24	\$113.54	25-49	\$107.57	50+	\$102.79									
	PRICE																																																	
1-24	\$98.25																																																	
25-49	\$93.34																																																	
50-99	\$88.43																																																	
100+	\$84.50																																																	
PRICE																																																		
1-9	\$141.81																																																	
10-24	\$134.72																																																	
25-49	\$127.63																																																	
50+	\$121.96																																																	
PRICE																																																		
1-24	\$52.30																																																	
25-49	\$49.69																																																	
50-99	\$47.07																																																	
100+	\$44.98																																																	
PRICE																																																		
1-9	\$119.52																																																	
10-24	\$113.54																																																	
25-49	\$107.57																																																	
50+	\$102.79																																																	
6	 <table border="1"> <thead> <tr><th>PRICE</th></tr> </thead> <tbody> <tr><td>1-9</td><td>\$107.89</td></tr> <tr><td>10-24</td><td>\$102.50</td></tr> <tr><td>25-49</td><td>\$97.10</td></tr> <tr><td>50+</td><td>\$92.79</td></tr> </tbody> </table> <p>Low PIM 50+</p> <p>SMA Male to 7/16 DIN Female</p> <p>Max. Freq. 8 GHz</p> <p>Model No: PE91041</p>	PRICE	1-9	\$107.89	10-24	\$102.50	25-49	\$97.10	50+	\$92.79	 <table border="1"> <thead> <tr><th>PRICE</th></tr> </thead> <tbody> <tr><td>1-24</td><td>\$90.94</td></tr> <tr><td>25-49</td><td>\$86.39</td></tr> <tr><td>50-99</td><td>\$81.85</td></tr> <tr><td>100+</td><td>\$78.21</td></tr> </tbody> </table> <p>Low PIM 100+</p> <p>SMA Female to 7/16 DIN Male</p> <p>VSWR 1.09:1 to 7.5 GHz</p> <p>Model No: PE91036</p>	PRICE	1-24	\$90.94	25-49	\$86.39	50-99	\$81.85	100+	\$78.21	 <table border="1"> <thead> <tr><th>PRICE</th></tr> </thead> <tbody> <tr><td>1-24</td><td>\$91.69</td></tr> <tr><td>25-49</td><td>\$87.11</td></tr> <tr><td>50-99</td><td>\$82.52</td></tr> <tr><td>100+</td><td>\$78.85</td></tr> </tbody> </table> <p>Low PIM 100+</p> <p>SMA Female to 7/16 DIN Female</p> <p>Max. Freq. 8 GHz</p> <p>Model No: PE91042</p>	PRICE	1-24	\$91.69	25-49	\$87.11	50-99	\$82.52	100+	\$78.85	<p>TNC</p> <p><i>In-Series</i></p> <p>→</p>	 <table border="1"> <thead> <tr><th>PRICE</th></tr> </thead> <tbody> <tr><td>1-24</td><td>\$61.44</td></tr> <tr><td>25-49</td><td>\$58.37</td></tr> <tr><td>50-99</td><td>\$55.30</td></tr> <tr><td>100+</td><td>\$52.84</td></tr> </tbody> </table> <p>Low PIM 100+</p> <p>TNC Male to TNC Male</p> <p>VSWR 1.25:1 to 6 GHz</p> <p>Model No: PE91172</p>	PRICE	1-24	\$61.44	25-49	\$58.37	50-99	\$55.30	100+	\$52.84									
	PRICE																																																	
1-9	\$107.89																																																	
10-24	\$102.50																																																	
25-49	\$97.10																																																	
50+	\$92.79																																																	
PRICE																																																		
1-24	\$90.94																																																	
25-49	\$86.39																																																	
50-99	\$81.85																																																	
100+	\$78.21																																																	
PRICE																																																		
1-24	\$91.69																																																	
25-49	\$87.11																																																	
50-99	\$82.52																																																	
100+	\$78.85																																																	
PRICE																																																		
1-24	\$61.44																																																	
25-49	\$58.37																																																	
50-99	\$55.30																																																	
100+	\$52.84																																																	
7	 <table border="1"> <thead> <tr><th>PRICE</th></tr> </thead> <tbody> <tr><td>1-24</td><td>\$58.54</td></tr> <tr><td>25-49</td><td>\$55.61</td></tr> <tr><td>50-99</td><td>\$52.69</td></tr> <tr><td>100+</td><td>\$50.34</td></tr> </tbody> </table> <p>Low PIM 100+</p> <p>TNC Male to TNC Female</p> <p>VSWR 1.25:1 to 6 GHz</p> <p>Model No: PE91173</p>	PRICE	1-24	\$58.54	25-49	\$55.61	50-99	\$52.69	100+	\$50.34	 <table border="1"> <thead> <tr><th>PRICE</th></tr> </thead> <tbody> <tr><td>1-24</td><td>\$53.66</td></tr> <tr><td>25-49</td><td>\$50.98</td></tr> <tr><td>50-99</td><td>\$48.29</td></tr> <tr><td>100+</td><td>\$46.15</td></tr> </tbody> </table> <p>Low PIM 100+</p> <p>TNC Female to TNC Female</p> <p>VSWR 1.25:1 to 6 GHz</p> <p>Model No: PE91174</p>	PRICE	1-24	\$53.66	25-49	\$50.98	50-99	\$48.29	100+	\$46.15																														
	PRICE																																																	
1-24	\$58.54																																																	
25-49	\$55.61																																																	
50-99	\$52.69																																																	
100+	\$50.34																																																	
PRICE																																																		
1-24	\$53.66																																																	
25-49	\$50.98																																																	
50-99	\$48.29																																																	
100+	\$46.15																																																	

See Our Website For Current Pricing & Real-Time Stock Availability!

ADAPTERS

See Adapter Locator on Pages 8-13

See Page 369 for Mounting Holes

Adapters

See Our Website For Current Pricing & Real-Time Stock Availability!

	A	B	C	D	E																																								
1	<p>1.0mm In-Series</p>  <p>Model No: PE91462</p>	<p>PRICE</p> <table border="1"> <tr><td>1-24</td><td>\$1,697.14</td></tr> <tr><td>25-49</td><td>\$1,578.34</td></tr> <tr><td>50-99</td><td>\$1,459.54</td></tr> <tr><td>NEW 100+</td><td>\$1,357.71</td></tr> </table> <p>1.0mm Male to 1.0mm Male VSWR 1.28:1 to 110 GHz</p> <p>Model No: PE91462</p>	1-24	\$1,697.14	25-49	\$1,578.34	50-99	\$1,459.54	NEW 100+	\$1,357.71	<p>PRICE</p> <table border="1"> <tr><td>1-1</td><td>\$1,763.33</td></tr> <tr><td>2-4</td><td>\$1,692.80</td></tr> <tr><td>5-9</td><td>\$1,622.26</td></tr> <tr><td>NEW 10+</td><td>\$1,551.73</td></tr> </table> <p>1.0mm Female to 1.0mm Male VSWR 1.28:1 to 110 GHz</p> <p>Model No: PE91461</p>	1-1	\$1,763.33	2-4	\$1,692.80	5-9	\$1,622.26	NEW 10+	\$1,551.73	<p>PRICE</p> <table border="1"> <tr><td>1-1</td><td>\$1,763.33</td></tr> <tr><td>2-4</td><td>\$1,692.80</td></tr> <tr><td>5-9</td><td>\$1,622.26</td></tr> <tr><td>NEW 10+</td><td>\$1,551.73</td></tr> </table> <p>1.0mm Female to 1.0mm Female VSWR 1.28:1 to 110 GHz</p> <p>Model No: PE91463</p>	1-1	\$1,763.33	2-4	\$1,692.80	5-9	\$1,622.26	NEW 10+	\$1,551.73	<p>1.0mm Between Series</p> 																
1-24	\$1,697.14																																												
25-49	\$1,578.34																																												
50-99	\$1,459.54																																												
NEW 100+	\$1,357.71																																												
1-1	\$1,763.33																																												
2-4	\$1,692.80																																												
5-9	\$1,622.26																																												
NEW 10+	\$1,551.73																																												
1-1	\$1,763.33																																												
2-4	\$1,692.80																																												
5-9	\$1,622.26																																												
NEW 10+	\$1,551.73																																												
2	<p>PRICE</p> <table border="1"> <tr><td>1-4</td><td>\$727.91</td></tr> <tr><td>5-9</td><td>\$691.51</td></tr> <tr><td>10-24</td><td>\$655.12</td></tr> <tr><td>25+</td><td>\$626.00</td></tr> </table> <p>1.0mm Male to 1.85mm Male VSWR 1.25:1 to 65 GHz</p> <p>Model No: PE91118</p>	1-4	\$727.91	5-9	\$691.51	10-24	\$655.12	25+	\$626.00	<p>PRICE</p> <table border="1"> <tr><td>1-4</td><td>\$620.90</td></tr> <tr><td>5-9</td><td>\$589.86</td></tr> <tr><td>10-24</td><td>\$558.81</td></tr> <tr><td>25+</td><td>\$533.97</td></tr> </table> <p>1.0mm Male to 1.85mm Female VSWR 1.35:1 to 65 GHz</p> <p>Model No: PE91108</p>	1-4	\$620.90	5-9	\$589.86	10-24	\$558.81	25+	\$533.97	<p>PRICE</p> <table border="1"> <tr><td>1-4</td><td>\$588.96</td></tr> <tr><td>5-9</td><td>\$559.51</td></tr> <tr><td>10-24</td><td>\$530.06</td></tr> <tr><td>25+</td><td>\$506.51</td></tr> </table> <p>1.0mm Female to 1.85mm Male VSWR 1.25:1 to 65 GHz</p> <p>Model No: PE91119</p>	1-4	\$588.96	5-9	\$559.51	10-24	\$530.06	25+	\$506.51	<p>PRICE</p> <table border="1"> <tr><td>1-4</td><td>\$620.90</td></tr> <tr><td>5-9</td><td>\$589.86</td></tr> <tr><td>10-24</td><td>\$558.81</td></tr> <tr><td>25+</td><td>\$533.97</td></tr> </table> <p>1.0mm Female to 1.85mm Female VSWR 1.35:1 to 65 GHz</p> <p>Model No: PE91109</p>	1-4	\$620.90	5-9	\$589.86	10-24	\$558.81	25+	\$533.97	<p>1.85mm In-Series</p> 								
1-4	\$727.91																																												
5-9	\$691.51																																												
10-24	\$655.12																																												
25+	\$626.00																																												
1-4	\$620.90																																												
5-9	\$589.86																																												
10-24	\$558.81																																												
25+	\$533.97																																												
1-4	\$588.96																																												
5-9	\$559.51																																												
10-24	\$530.06																																												
25+	\$506.51																																												
1-4	\$620.90																																												
5-9	\$589.86																																												
10-24	\$558.81																																												
25+	\$533.97																																												
3	<p>PRICE</p> <table border="1"> <tr><td>1-4</td><td>\$784.38</td></tr> <tr><td>5-9</td><td>\$745.16</td></tr> <tr><td>10-24</td><td>\$705.94</td></tr> <tr><td>25+</td><td>\$674.57</td></tr> </table> <p>1.85mm Male to 1.85mm Male VSWR 1.35:1 to 67 GHz</p> <p>Model No: PE91085</p>	1-4	\$784.38	5-9	\$745.16	10-24	\$705.94	25+	\$674.57	<p>PRICE</p> <table border="1"> <tr><td>1-4</td><td>\$705.79</td></tr> <tr><td>5-9</td><td>\$670.50</td></tr> <tr><td>10-24</td><td>\$635.21</td></tr> <tr><td>25+</td><td>\$606.98</td></tr> </table> <p>1.85mm Male to 1.85mm Male VSWR 1.5:1 to 65 GHz</p> <p>Model No: PE9716</p>	1-4	\$705.79	5-9	\$670.50	10-24	\$635.21	25+	\$606.98	<p>PRICE</p> <table border="1"> <tr><td>1-4</td><td>\$719.61</td></tr> <tr><td>5-9</td><td>\$683.63</td></tr> <tr><td>10-24</td><td>\$647.65</td></tr> <tr><td>25+</td><td>\$618.86</td></tr> </table> <p>1.85mm Male to 1.85mm Female VSWR 1.35:1 to 67 GHz</p> <p>Model No: PE91086</p>	1-4	\$719.61	5-9	\$683.63	10-24	\$647.65	25+	\$618.86	<p>PRICE</p> <table border="1"> <tr><td>1-4</td><td>\$705.79</td></tr> <tr><td>5-9</td><td>\$670.50</td></tr> <tr><td>10-24</td><td>\$635.21</td></tr> <tr><td>25+</td><td>\$606.98</td></tr> </table> <p>1.85mm Male to 1.85mm Female VSWR 1.5:1 to 65 GHz</p> <p>Model No: PE9715</p>	1-4	\$705.79	5-9	\$670.50	10-24	\$635.21	25+	\$606.98	<p>PRICE</p> <table border="1"> <tr><td>1-4</td><td>\$719.61</td></tr> <tr><td>5-9</td><td>\$683.63</td></tr> <tr><td>10-24</td><td>\$647.65</td></tr> <tr><td>25+</td><td>\$618.86</td></tr> </table> <p>1.85mm Female to 1.85mm Female Max. Freq. 67 GHz</p> <p>Model No: PE91084</p>	1-4	\$719.61	5-9	\$683.63	10-24	\$647.65	25+	\$618.86
1-4	\$784.38																																												
5-9	\$745.16																																												
10-24	\$705.94																																												
25+	\$674.57																																												
1-4	\$705.79																																												
5-9	\$670.50																																												
10-24	\$635.21																																												
25+	\$606.98																																												
1-4	\$719.61																																												
5-9	\$683.63																																												
10-24	\$647.65																																												
25+	\$618.86																																												
1-4	\$705.79																																												
5-9	\$670.50																																												
10-24	\$635.21																																												
25+	\$606.98																																												
1-4	\$719.61																																												
5-9	\$683.63																																												
10-24	\$647.65																																												
25+	\$618.86																																												
4	<p>PRICE</p> <table border="1"> <tr><td>1-4</td><td>\$595.19</td></tr> <tr><td>5-9</td><td>\$565.43</td></tr> <tr><td>10-24</td><td>\$535.67</td></tr> <tr><td>25+</td><td>\$511.86</td></tr> </table> <p>1.85mm Female to 1.85mm Female VSWR 1.25:1 to 67 GHz</p> <p>Model No: PE91115</p>	1-4	\$595.19	5-9	\$565.43	10-24	\$535.67	25+	\$511.86	<p>1.85mm Between Series</p> 	<p>PRICE</p> <table border="1"> <tr><td>1-24</td><td>\$371.10</td></tr> <tr><td>25-49</td><td>\$345.12</td></tr> <tr><td>50-99</td><td>\$319.15</td></tr> <tr><td>100+</td><td>\$296.88</td></tr> </table> <p>1.85mm Male to 2.92mm Male Right Angle VSWR 1.3:1 to 40 GHz</p> <p>Model No: PE91161</p>	1-24	\$371.10	25-49	\$345.12	50-99	\$319.15	100+	\$296.88	<p>PRICE</p> <table border="1"> <tr><td>1-9</td><td>\$217.17</td></tr> <tr><td>10-24</td><td>\$206.31</td></tr> <tr><td>25-49</td><td>\$195.45</td></tr> <tr><td>50+</td><td>\$186.77</td></tr> </table> <p>1.85mm Male to 3.5mm Female VSWR 1.3:1 to 34 GHz</p> <p>Model No: PE9747</p>	1-9	\$217.17	10-24	\$206.31	25-49	\$195.45	50+	\$186.77	<p>PRICE</p> <table border="1"> <tr><td>1-9</td><td>\$215.82</td></tr> <tr><td>10-24</td><td>\$205.03</td></tr> <tr><td>25-49</td><td>\$194.24</td></tr> <tr><td>50+</td><td>\$185.61</td></tr> </table> <p>1.85mm Male to N Male VSWR 1.25:1 to 18 GHz</p> <p>Model No: PE9718</p>	1-9	\$215.82	10-24	\$205.03	25-49	\$194.24	50+	\$185.61								
1-4	\$595.19																																												
5-9	\$565.43																																												
10-24	\$535.67																																												
25+	\$511.86																																												
1-24	\$371.10																																												
25-49	\$345.12																																												
50-99	\$319.15																																												
100+	\$296.88																																												
1-9	\$217.17																																												
10-24	\$206.31																																												
25-49	\$195.45																																												
50+	\$186.77																																												
1-9	\$215.82																																												
10-24	\$205.03																																												
25-49	\$194.24																																												
50+	\$185.61																																												
5	<p>PRICE</p> <table border="1"> <tr><td>1-9</td><td>\$219.75</td></tr> <tr><td>10-24</td><td>\$208.76</td></tr> <tr><td>25-49</td><td>\$197.78</td></tr> <tr><td>50+</td><td>\$188.99</td></tr> </table> <p>1.85mm Male to N Female VSWR 1.25:1 to 18 GHz</p> <p>Model No: PE9719</p>	1-9	\$219.75	10-24	\$208.76	25-49	\$197.78	50+	\$188.99	<p>PRICE</p> <table border="1"> <tr><td>1-9</td><td>\$392.03</td></tr> <tr><td>10-24</td><td>\$372.43</td></tr> <tr><td>25-49</td><td>\$352.83</td></tr> <tr><td>50+</td><td>\$337.15</td></tr> </table> <p>1.85mm Female to 2.4mm Female Right Angle VSWR 1.4:1 to 50 GHz</p> <p>Model No: PE91159</p>	1-9	\$392.03	10-24	\$372.43	25-49	\$352.83	50+	\$337.15	<p>PRICE</p> <table border="1"> <tr><td>1-24</td><td>\$371.09</td></tr> <tr><td>25-49</td><td>\$345.11</td></tr> <tr><td>50-99</td><td>\$319.14</td></tr> <tr><td>100+</td><td>\$296.87</td></tr> </table> <p>1.85mm Female to 2.92mm Male Right Angle VSWR 1.3:1 to 40 GHz</p> <p>Model No: PE91162</p>	1-24	\$371.09	25-49	\$345.11	50-99	\$319.14	100+	\$296.87	<p>PRICE</p> <table border="1"> <tr><td>1-9</td><td>\$233.16</td></tr> <tr><td>10-24</td><td>\$221.50</td></tr> <tr><td>25-49</td><td>\$209.84</td></tr> <tr><td>50+</td><td>\$200.52</td></tr> </table> <p>1.85mm Female to N Male VSWR 1.25:1 to 18 GHz</p> <p>Model No: PE9720</p>	1-9	\$233.16	10-24	\$221.50	25-49	\$209.84	50+	\$200.52	<p>PRICE</p> <table border="1"> <tr><td>1-9</td><td>\$219.75</td></tr> <tr><td>10-24</td><td>\$208.76</td></tr> <tr><td>25-49</td><td>\$197.78</td></tr> <tr><td>50+</td><td>\$188.99</td></tr> </table> <p>1.85mm Female to N Female VSWR 1.25:1 to 18 GHz</p> <p>Model No: PE9721</p>	1-9	\$219.75	10-24	\$208.76	25-49	\$197.78	50+	\$188.99
1-9	\$219.75																																												
10-24	\$208.76																																												
25-49	\$197.78																																												
50+	\$188.99																																												
1-9	\$392.03																																												
10-24	\$372.43																																												
25-49	\$352.83																																												
50+	\$337.15																																												
1-24	\$371.09																																												
25-49	\$345.11																																												
50-99	\$319.14																																												
100+	\$296.87																																												
1-9	\$233.16																																												
10-24	\$221.50																																												
25-49	\$209.84																																												
50+	\$200.52																																												
1-9	\$219.75																																												
10-24	\$208.76																																												
25-49	\$197.78																																												
50+	\$188.99																																												
6	<p>2.4mm In-Series</p> 	<p>PRICE</p> <table border="1"> <tr><td>1-9</td><td>\$211.17</td></tr> <tr><td>10-24</td><td>\$200.61</td></tr> <tr><td>25-49</td><td>\$190.05</td></tr> <tr><td>50+</td><td>\$181.61</td></tr> </table> <p>2.4mm Male to 2.4mm Male VSWR 1.3:1 to 50 GHz</p> <p>Model No: PE9451</p>	1-9	\$211.17	10-24	\$200.61	25-49	\$190.05	50+	\$181.61	<p>PRICE</p> <table border="1"> <tr><td>1-9</td><td>\$215.28</td></tr> <tr><td>10-24</td><td>\$204.52</td></tr> <tr><td>25-49</td><td>\$193.75</td></tr> <tr><td>50+</td><td>\$185.14</td></tr> </table> <p>2.4mm Male to 2.4mm Female VSWR 1.3:1 to 50 GHz</p> <p>Model No: PE9452</p>	1-9	\$215.28	10-24	\$204.52	25-49	\$193.75	50+	\$185.14	<p>PRICE</p> <table border="1"> <tr><td>1-9</td><td>\$211.17</td></tr> <tr><td>10-24</td><td>\$200.61</td></tr> <tr><td>25-49</td><td>\$190.05</td></tr> <tr><td>50+</td><td>\$181.61</td></tr> </table> <p>2.4mm Female to 2.4mm Female VSWR 1.3:1 to 50 GHz</p> <p>Model No: PE9453</p>	1-9	\$211.17	10-24	\$200.61	25-49	\$190.05	50+	\$181.61	<p>PRICE</p> <table border="1"> <tr><td>1-24</td><td>\$191.93</td></tr> <tr><td>25-49</td><td>\$182.33</td></tr> <tr><td>50-99</td><td>\$172.74</td></tr> <tr><td>NEW 100+</td><td>\$165.06</td></tr> </table> <p>2.4mm Female to 2.4mm Female Bulkhead VSWR 1.3:1 to 50 GHz</p> <p>Model No: PE91459</p>	1-24	\$191.93	25-49	\$182.33	50-99	\$172.74	NEW 100+	\$165.06								
1-9	\$211.17																																												
10-24	\$200.61																																												
25-49	\$190.05																																												
50+	\$181.61																																												
1-9	\$215.28																																												
10-24	\$204.52																																												
25-49	\$193.75																																												
50+	\$185.14																																												
1-9	\$211.17																																												
10-24	\$200.61																																												
25-49	\$190.05																																												
50+	\$181.61																																												
1-24	\$191.93																																												
25-49	\$182.33																																												
50-99	\$172.74																																												
NEW 100+	\$165.06																																												
7	<p>PRICE</p> <table border="1"> <tr><td>1-9</td><td>\$413.19</td></tr> <tr><td>10-24</td><td>\$392.53</td></tr> <tr><td>25-49</td><td>\$371.87</td></tr> <tr><td>50+</td><td>\$355.34</td></tr> </table> <p>2.4mm Female to 2.4mm Female Bulkhead VSWR 1.35:1 to 50 GHz</p> <p>Model No: PE9640</p>	1-9	\$413.19	10-24	\$392.53	25-49	\$371.87	50+	\$355.34	<p>2.4mm Between Series</p> 	<p>PRICE</p> <table border="1"> <tr><td>1-4</td><td>\$602.78</td></tr> <tr><td>5-9</td><td>\$572.64</td></tr> <tr><td>10-24</td><td>\$542.50</td></tr> <tr><td>25+</td><td>\$518.39</td></tr> </table> <p>2.4mm Male to 1.85mm Male VSWR 1.3:1 to 50 GHz</p> <p>Model No: PE9672</p>	1-4	\$602.78	5-9	\$572.64	10-24	\$542.50	25+	\$518.39	<p>PRICE</p> <table border="1"> <tr><td>1-9</td><td>\$383.29</td></tr> <tr><td>10-24</td><td>\$364.13</td></tr> <tr><td>25-49</td><td>\$344.96</td></tr> <tr><td>50+</td><td>\$329.63</td></tr> </table> <p>2.4mm Male to 1.85mm Female VSWR 1.3:1 to 50 GHz</p> <p>Model No: PE9674</p>	1-9	\$383.29	10-24	\$364.13	25-49	\$344.96	50+	\$329.63	<p>PRICE</p> <table border="1"> <tr><td>1-24</td><td>\$393.60</td></tr> <tr><td>25-49</td><td>\$366.05</td></tr> <tr><td>50-99</td><td>\$338.50</td></tr> <tr><td>100+</td><td>\$314.88</td></tr> </table> <p>2.4mm Male to 2.92mm Male Miter Right Angle VSWR 1.25:1 to 40 GHz</p> <p>Model No: PE91508</p>	1-24	\$393.60	25-49	\$366.05	50-99	\$338.50	100+	\$314.88								
1-9	\$413.19																																												
10-24	\$392.53																																												
25-49	\$371.87																																												
50+	\$355.34																																												
1-4	\$602.78																																												
5-9	\$572.64																																												
10-24	\$542.50																																												
25+	\$518.39																																												
1-9	\$383.29																																												
10-24	\$364.13																																												
25-49	\$344.96																																												
50+	\$329.63																																												
1-24	\$393.60																																												
25-49	\$366.05																																												
50-99	\$338.50																																												
100+	\$314.88																																												

ADAPTERS

See Adapter Locator on Pages 8-13

See Page 369 for Mounting Holes

	A	B	C	D	E																																													
1	 <table border="1"> <thead> <tr><th>PRICE</th></tr> </thead> <tbody> <tr><td>1-24</td><td>\$337.70</td></tr> <tr><td>25-49</td><td>\$314.06</td></tr> <tr><td>50-99</td><td>\$290.42</td></tr> <tr><td>100+</td><td>\$270.16</td></tr> </tbody> </table> <p>2.4mm Male to 2.92mm Female Miter Right Angle VSWR 1.25:1 to 40 GHz</p> <p>Model No: PE91502</p>	PRICE	1-24	\$337.70	25-49	\$314.06	50-99	\$290.42	100+	\$270.16	 <table border="1"> <thead> <tr><th>PRICE</th></tr> </thead> <tbody> <tr><td>1-4</td><td>\$703.42</td></tr> <tr><td>5-9</td><td>\$668.25</td></tr> <tr><td>10-24</td><td>\$633.08</td></tr> <tr><td>25+</td><td>\$604.94</td></tr> </tbody> </table> <p>2.4mm Male to 7mm Sexless VSWR 1.1:1 to 18 GHz</p> <p>Model No: PE9458</p>	PRICE	1-4	\$703.42	5-9	\$668.25	10-24	\$633.08	25+	\$604.94	 <table border="1"> <thead> <tr><th>PRICE</th></tr> </thead> <tbody> <tr><td>1-9</td><td>\$285.27</td></tr> <tr><td>10-24</td><td>\$271.01</td></tr> <tr><td>25-49</td><td>\$256.74</td></tr> <tr><td>50+</td><td>\$245.33</td></tr> </tbody> </table> <p>2.4mm Male to Full Detent Mini SMP Male VSWR 1.25:1 to 50 GHz</p> <p>Model No: PE91121</p>	PRICE	1-9	\$285.27	10-24	\$271.01	25-49	\$256.74	50+	\$245.33	 <table border="1"> <thead> <tr><th>PRICE</th></tr> </thead> <tbody> <tr><td>1-9</td><td>\$293.12</td></tr> <tr><td>10-24</td><td>\$278.46</td></tr> <tr><td>25-49</td><td>\$263.81</td></tr> <tr><td>50+</td><td>\$252.08</td></tr> </tbody> </table> <p>2.4mm Male to Mini SMP Female VSWR 1.25:1 to 50 GHz</p> <p>Model No: PE91120</p>	PRICE	1-9	\$293.12	10-24	\$278.46	25-49	\$263.81	50+	\$252.08	 <table border="1"> <thead> <tr><th>PRICE</th></tr> </thead> <tbody> <tr><td>1-9</td><td>\$223.14</td></tr> <tr><td>10-24</td><td>\$211.98</td></tr> <tr><td>25-49</td><td>\$200.83</td></tr> <tr><td>50+</td><td>\$191.90</td></tr> </tbody> </table> <p>PRECISION 2.4mm Male to N Male VSWR 1.15:1 to 18 GHz</p> <p>Model No: PE9504</p>	PRICE	1-9	\$223.14	10-24	\$211.98	25-49	\$200.83	50+	\$191.90
	PRICE																																																	
1-24	\$337.70																																																	
25-49	\$314.06																																																	
50-99	\$290.42																																																	
100+	\$270.16																																																	
PRICE																																																		
1-4	\$703.42																																																	
5-9	\$668.25																																																	
10-24	\$633.08																																																	
25+	\$604.94																																																	
PRICE																																																		
1-9	\$285.27																																																	
10-24	\$271.01																																																	
25-49	\$256.74																																																	
50+	\$245.33																																																	
PRICE																																																		
1-9	\$293.12																																																	
10-24	\$278.46																																																	
25-49	\$263.81																																																	
50+	\$252.08																																																	
PRICE																																																		
1-9	\$223.14																																																	
10-24	\$211.98																																																	
25-49	\$200.83																																																	
50+	\$191.90																																																	
2	 <table border="1"> <thead> <tr><th>PRICE</th></tr> </thead> <tbody> <tr><td>1-9</td><td>\$239.04</td></tr> <tr><td>10-24</td><td>\$227.09</td></tr> <tr><td>25-49</td><td>\$215.14</td></tr> <tr><td>50+</td><td>\$205.57</td></tr> </tbody> </table> <p>PRECISION 2.4mm Male to N Female VSWR 1.15:1 to 18 GHz</p> <p>Model No: PE9501</p>	PRICE	1-9	\$239.04	10-24	\$227.09	25-49	\$215.14	50+	\$205.57	 <table border="1"> <thead> <tr><th>PRICE</th></tr> </thead> <tbody> <tr><td>1-4</td><td>\$569.84</td></tr> <tr><td>5-9</td><td>\$541.35</td></tr> <tr><td>10-24</td><td>\$512.86</td></tr> <tr><td>25+</td><td>\$490.06</td></tr> </tbody> </table> <p>2.4mm Female to 1.85mm Male VSWR 1.3:1 to 50 GHz</p> <p>Model No: PE9673</p>	PRICE	1-4	\$569.84	5-9	\$541.35	10-24	\$512.86	25+	\$490.06	 <table border="1"> <thead> <tr><th>PRICE</th></tr> </thead> <tbody> <tr><td>1-4</td><td>\$566.37</td></tr> <tr><td>5-9</td><td>\$538.05</td></tr> <tr><td>10-24</td><td>\$509.73</td></tr> <tr><td>25+</td><td>\$487.08</td></tr> </tbody> </table> <p>2.4mm Female to 1.85mm Female VSWR 1.3:1 to 50 GHz</p> <p>Model No: PE9675</p>	PRICE	1-4	\$566.37	5-9	\$538.05	10-24	\$509.73	25+	\$487.08	 <table border="1"> <thead> <tr><th>PRICE</th></tr> </thead> <tbody> <tr><td>1-9</td><td>\$303.36</td></tr> <tr><td>10-24</td><td>\$288.19</td></tr> <tr><td>25-49</td><td>\$273.02</td></tr> <tr><td>50+</td><td>\$260.89</td></tr> </tbody> </table> <p>2.4mm Female to Full Detent Mini SMP Male VSWR 1.25:1 to 50 GHz</p> <p>Model No: PE91122</p>	PRICE	1-9	\$303.36	10-24	\$288.19	25-49	\$273.02	50+	\$260.89	 <table border="1"> <thead> <tr><th>PRICE</th></tr> </thead> <tbody> <tr><td>1-9</td><td>\$285.24</td></tr> <tr><td>10-24</td><td>\$270.98</td></tr> <tr><td>25-49</td><td>\$256.72</td></tr> <tr><td>50+</td><td>\$245.31</td></tr> </tbody> </table> <p>2.4mm Female to Mini SMP Female VSWR 1.25:1 to 50 GHz</p> <p>Model No: PE91123</p>	PRICE	1-9	\$285.24	10-24	\$270.98	25-49	\$256.72	50+	\$245.31
	PRICE																																																	
1-9	\$239.04																																																	
10-24	\$227.09																																																	
25-49	\$215.14																																																	
50+	\$205.57																																																	
PRICE																																																		
1-4	\$569.84																																																	
5-9	\$541.35																																																	
10-24	\$512.86																																																	
25+	\$490.06																																																	
PRICE																																																		
1-4	\$566.37																																																	
5-9	\$538.05																																																	
10-24	\$509.73																																																	
25+	\$487.08																																																	
PRICE																																																		
1-9	\$303.36																																																	
10-24	\$288.19																																																	
25-49	\$273.02																																																	
50+	\$260.89																																																	
PRICE																																																		
1-9	\$285.24																																																	
10-24	\$270.98																																																	
25-49	\$256.72																																																	
50+	\$245.31																																																	
3	 <table border="1"> <thead> <tr><th>PRICE</th></tr> </thead> <tbody> <tr><td>1-9</td><td>\$236.42</td></tr> <tr><td>10-24</td><td>\$224.60</td></tr> <tr><td>25-49</td><td>\$212.78</td></tr> <tr><td>50+</td><td>\$203.32</td></tr> </tbody> </table> <p>PRECISION 2.4mm Female to N Male VSWR 1.15:1 to 18 GHz</p> <p>Model No: PE9503</p>	PRICE	1-9	\$236.42	10-24	\$224.60	25-49	\$212.78	50+	\$203.32	 <table border="1"> <thead> <tr><th>PRICE</th></tr> </thead> <tbody> <tr><td>1-9</td><td>\$231.78</td></tr> <tr><td>10-24</td><td>\$220.19</td></tr> <tr><td>25-49</td><td>\$208.60</td></tr> <tr><td>50+</td><td>\$199.33</td></tr> </tbody> </table> <p>PRECISION 2.4mm Female to N Female VSWR 1.15:1 to 18 GHz</p> <p>Model No: PE9502</p>	PRICE	1-9	\$231.78	10-24	\$220.19	25-49	\$208.60	50+	\$199.33	 <table border="1"> <thead> <tr><th>PRICE</th></tr> </thead> <tbody> <tr><td>1-9</td><td>\$287.53</td></tr> <tr><td>10-24</td><td>\$273.15</td></tr> <tr><td>25-49</td><td>\$258.78</td></tr> <tr><td>50+</td><td>\$247.28</td></tr> </tbody> </table> <p>2.4mm Female to SMP Male VSWR 1.25:1 to 40 GHz</p> <p>Model No: PE91048</p>	PRICE	1-9	\$287.53	10-24	\$273.15	25-49	\$258.78	50+	\$247.28	 <table border="1"> <thead> <tr><th>PRICE</th></tr> </thead> <tbody> <tr><td>1-9</td><td>\$313.41</td></tr> <tr><td>10-24</td><td>\$297.74</td></tr> <tr><td>25-49</td><td>\$282.07</td></tr> <tr><td>50+</td><td>\$269.53</td></tr> </tbody> </table> <p>2.4mm Female to SMP Female VSWR 1.25:1 to 40 GHz</p> <p>Model No: PE91055</p>	PRICE	1-9	\$313.41	10-24	\$297.74	25-49	\$282.07	50+	\$269.53	<div style="text-align: center;"> <p>2.4mm NMD Between Series</p> <p>→</p> </div>									
	PRICE																																																	
1-9	\$236.42																																																	
10-24	\$224.60																																																	
25-49	\$212.78																																																	
50+	\$203.32																																																	
PRICE																																																		
1-9	\$231.78																																																	
10-24	\$220.19																																																	
25-49	\$208.60																																																	
50+	\$199.33																																																	
PRICE																																																		
1-9	\$287.53																																																	
10-24	\$273.15																																																	
25-49	\$258.78																																																	
50+	\$247.28																																																	
PRICE																																																		
1-9	\$313.41																																																	
10-24	\$297.74																																																	
25-49	\$282.07																																																	
50+	\$269.53																																																	
4	 <table border="1"> <thead> <tr><th>PRICE</th></tr> </thead> <tbody> <tr><td>1-9</td><td>\$334.04</td></tr> <tr><td>10-24</td><td>\$317.34</td></tr> <tr><td>25-49</td><td>\$300.64</td></tr> <tr><td>50+</td><td>\$287.27</td></tr> </tbody> </table> <p>2.4mm NMD Female to 2.4mm Female Max. Freq. 50 GHz</p> <p>Model No: PE91145</p>	PRICE	1-9	\$334.04	10-24	\$317.34	25-49	\$300.64	50+	\$287.27	 <table border="1"> <thead> <tr><th>PRICE</th></tr> </thead> <tbody> <tr><td>1-9</td><td>\$316.15</td></tr> <tr><td>10-24</td><td>\$300.34</td></tr> <tr><td>25-49</td><td>\$284.54</td></tr> <tr><td>50+</td><td>\$271.89</td></tr> </tbody> </table> <p>Ruggedized 2.4mm NMD Female to SMA Female VSWR 1.2:1 to 27 GHz</p> <p>Model No: PE91146</p>	PRICE	1-9	\$316.15	10-24	\$300.34	25-49	\$284.54	50+	\$271.89	<div style="text-align: center;"> <p>2.92mm In-Series</p> <p>→</p> </div>	 <table border="1"> <thead> <tr><th>PRICE</th></tr> </thead> <tbody> <tr><td>1-9</td><td>\$193.36</td></tr> <tr><td>10-24</td><td>\$183.69</td></tr> <tr><td>25-49</td><td>\$174.02</td></tr> <tr><td>50+</td><td>\$166.29</td></tr> </tbody> </table> <p>2.92mm Male to 2.92mm Male VSWR 1.25:1 to 40 GHz</p> <p>Model No: PE9436</p>	PRICE	1-9	\$193.36	10-24	\$183.69	25-49	\$174.02	50+	\$166.29	 <table border="1"> <thead> <tr><th>PRICE</th></tr> </thead> <tbody> <tr><td>1-9</td><td>\$302.57</td></tr> <tr><td>10-24</td><td>\$287.44</td></tr> <tr><td>25-49</td><td>\$272.31</td></tr> <tr><td>50+</td><td>\$260.21</td></tr> </tbody> </table> <p>2.92mm Male to 2.92mm Male Right Angle VSWR 1.3:1 to 40 GHz</p> <p>Model No: PE9645</p>	PRICE	1-9	\$302.57	10-24	\$287.44	25-49	\$272.31	50+	\$260.21									
	PRICE																																																	
1-9	\$334.04																																																	
10-24	\$317.34																																																	
25-49	\$300.64																																																	
50+	\$287.27																																																	
PRICE																																																		
1-9	\$316.15																																																	
10-24	\$300.34																																																	
25-49	\$284.54																																																	
50+	\$271.89																																																	
PRICE																																																		
1-9	\$193.36																																																	
10-24	\$183.69																																																	
25-49	\$174.02																																																	
50+	\$166.29																																																	
PRICE																																																		
1-9	\$302.57																																																	
10-24	\$287.44																																																	
25-49	\$272.31																																																	
50+	\$260.21																																																	
5	 <table border="1"> <thead> <tr><th>PRICE</th></tr> </thead> <tbody> <tr><td>1-9</td><td>\$198.91</td></tr> <tr><td>10-24</td><td>\$188.96</td></tr> <tr><td>25-49</td><td>\$179.02</td></tr> <tr><td>50+</td><td>\$171.06</td></tr> </tbody> </table> <p>2.92mm Male to 2.92mm Female VSWR 1.25:1 to 40 GHz</p> <p>Model No: PE9437</p>	PRICE	1-9	\$198.91	10-24	\$188.96	25-49	\$179.02	50+	\$171.06	 <table border="1"> <thead> <tr><th>PRICE</th></tr> </thead> <tbody> <tr><td>1-24</td><td>\$76.40</td></tr> <tr><td>25-49</td><td>\$72.58</td></tr> <tr><td>50-99</td><td>\$68.76</td></tr> <tr><td>100+</td><td>\$65.70</td></tr> </tbody> </table> <p>2.92mm Female to 2.92mm Female VSWR 1.25:1 to 40 GHz</p> <p>Model No: PE91510</p>	PRICE	1-24	\$76.40	25-49	\$72.58	50-99	\$68.76	100+	\$65.70	 <table border="1"> <thead> <tr><th>PRICE</th></tr> </thead> <tbody> <tr><td>1-9</td><td>\$194.80</td></tr> <tr><td>10-24</td><td>\$185.06</td></tr> <tr><td>25-49</td><td>\$175.32</td></tr> <tr><td>50+</td><td>\$167.53</td></tr> </tbody> </table> <p>2.92mm Female to 2.92mm Female VSWR 1.25:1 to 40 GHz</p> <p>Model No: PE9438</p>	PRICE	1-9	\$194.80	10-24	\$185.06	25-49	\$175.32	50+	\$167.53	 <table border="1"> <thead> <tr><th>PRICE</th></tr> </thead> <tbody> <tr><td>1-9</td><td>\$134.89</td></tr> <tr><td>10-24</td><td>\$128.15</td></tr> <tr><td>25-49</td><td>\$121.40</td></tr> <tr><td>50+</td><td>\$116.01</td></tr> </tbody> </table> <p>2.92mm Female to 2.92mm Female Bulkhead-Mounting Hole B02 VSWR 1.25:1 to 40 GHz</p> <p>Model No: PE9647</p>	PRICE	1-9	\$134.89	10-24	\$128.15	25-49	\$121.40	50+	\$116.01	 <table border="1"> <thead> <tr><th>PRICE</th></tr> </thead> <tbody> <tr><td>1-24</td><td>\$101.61</td></tr> <tr><td>25-49</td><td>\$97.55</td></tr> <tr><td>50-99</td><td>\$94.50</td></tr> <tr><td>100+</td><td>\$92.47</td></tr> </tbody> </table> <p>2.92mm Female to 2.92mm Female 4 Hole Flange VSWR 1.25:1 to 40 GHz</p> <p>Model No: PE91113</p>	PRICE	1-24	\$101.61	25-49	\$97.55	50-99	\$94.50	100+	\$92.47
	PRICE																																																	
1-9	\$198.91																																																	
10-24	\$188.96																																																	
25-49	\$179.02																																																	
50+	\$171.06																																																	
PRICE																																																		
1-24	\$76.40																																																	
25-49	\$72.58																																																	
50-99	\$68.76																																																	
100+	\$65.70																																																	
PRICE																																																		
1-9	\$194.80																																																	
10-24	\$185.06																																																	
25-49	\$175.32																																																	
50+	\$167.53																																																	
PRICE																																																		
1-9	\$134.89																																																	
10-24	\$128.15																																																	
25-49	\$121.40																																																	
50+	\$116.01																																																	
PRICE																																																		
1-24	\$101.61																																																	
25-49	\$97.55																																																	
50-99	\$94.50																																																	
100+	\$92.47																																																	
6	 <table border="1"> <thead> <tr><th>PRICE</th></tr> </thead> <tbody> <tr><td>1-9</td><td>\$220.70</td></tr> <tr><td>10-24</td><td>\$209.67</td></tr> <tr><td>25-49</td><td>\$198.63</td></tr> <tr><td>50+</td><td>\$189.80</td></tr> </tbody> </table> <p>2.92mm Female to 2.92mm Female 4 Hole Flange VSWR 1.35:1 to 40 GHz</p> <p>Model No: PE9648</p>	PRICE	1-9	\$220.70	10-24	\$209.67	25-49	\$198.63	50+	\$189.80	<div style="text-align: center;"> <p>2.92mm Between Series</p> <p>→</p> </div>	 <table border="1"> <thead> <tr><th>PRICE</th></tr> </thead> <tbody> <tr><td>1-4</td><td>\$534.25</td></tr> <tr><td>5-9</td><td>\$507.54</td></tr> <tr><td>10-24</td><td>\$480.83</td></tr> <tr><td>25+</td><td>\$459.46</td></tr> </tbody> </table> <p>2.92mm Male to 1.85mm Male VSWR 1.25:1 to 40 GHz</p> <p>Model No: PE9667</p>	PRICE	1-4	\$534.25	5-9	\$507.54	10-24	\$480.83	25+	\$459.46	 <table border="1"> <thead> <tr><th>PRICE</th></tr> </thead> <tbody> <tr><td>1-4</td><td>\$534.25</td></tr> <tr><td>5-9</td><td>\$507.54</td></tr> <tr><td>10-24</td><td>\$480.83</td></tr> <tr><td>25+</td><td>\$459.46</td></tr> </tbody> </table> <p>2.92mm Male to 1.85mm Female VSWR 1.25:1 to 40 GHz</p> <p>Model No: PE9666</p>	PRICE	1-4	\$534.25	5-9	\$507.54	10-24	\$480.83	25+	\$459.46	 <table border="1"> <thead> <tr><th>PRICE</th></tr> </thead> <tbody> <tr><td>1-9</td><td>\$239.40</td></tr> <tr><td>10-24</td><td>\$227.43</td></tr> <tr><td>25-49</td><td>\$215.46</td></tr> <tr><td>50+</td><td>\$205.88</td></tr> </tbody> </table> <p>2.92mm Male to 2.4mm Male VSWR 1.15:1 to 40 GHz</p> <p>Model No: PE91298</p>	PRICE	1-9	\$239.40	10-24	\$227.43	25-49	\$215.46	50+	\$205.88									
	PRICE																																																	
1-9	\$220.70																																																	
10-24	\$209.67																																																	
25-49	\$198.63																																																	
50+	\$189.80																																																	
PRICE																																																		
1-4	\$534.25																																																	
5-9	\$507.54																																																	
10-24	\$480.83																																																	
25+	\$459.46																																																	
PRICE																																																		
1-4	\$534.25																																																	
5-9	\$507.54																																																	
10-24	\$480.83																																																	
25+	\$459.46																																																	
PRICE																																																		
1-9	\$239.40																																																	
10-24	\$227.43																																																	
25-49	\$215.46																																																	
50+	\$205.88																																																	
7	 <table border="1"> <thead> <tr><th>PRICE</th></tr> </thead> <tbody> <tr><td>1-9</td><td>\$161.34</td></tr> <tr><td>10-24</td><td>\$153.27</td></tr> <tr><td>25-49</td><td>\$145.21</td></tr> <tr><td>50+</td><td>\$138.75</td></tr> </tbody> </table> <p>2.92mm Male to 2.4mm Male VSWR 1.3:1 to 40 GHz</p> <p>Model No: PE9457</p>	PRICE	1-9	\$161.34	10-24	\$153.27	25-49	\$145.21	50+	\$138.75	 <table border="1"> <thead> <tr><th>PRICE</th></tr> </thead> <tbody> <tr><td>1-9</td><td>\$237.13</td></tr> <tr><td>10-24</td><td>\$225.27</td></tr> <tr><td>25-49</td><td>\$213.42</td></tr> <tr><td>NEW 50+</td><td>\$203.93</td></tr> </tbody> </table> <p>2.92mm Male to 2.4mm Female VSWR 1.25:1 to 40 GHz</p> <p>Model No: PE91450</p>	PRICE	1-9	\$237.13	10-24	\$225.27	25-49	\$213.42	NEW 50+	\$203.93	 <table border="1"> <thead> <tr><th>PRICE</th></tr> </thead> <tbody> <tr><td>1-9</td><td>\$146.82</td></tr> <tr><td>10-24</td><td>\$139.48</td></tr> <tr><td>25-49</td><td>\$132.14</td></tr> <tr><td>50+</td><td>\$126.27</td></tr> </tbody> </table> <p>2.92mm Male to 2.4mm Female VSWR 1.3:1 to 40 GHz</p> <p>Model No: PE9455</p>	PRICE	1-9	\$146.82	10-24	\$139.48	25-49	\$132.14	50+	\$126.27	 <table border="1"> <thead> <tr><th>PRICE</th></tr> </thead> <tbody> <tr><td>1-9</td><td>\$327.08</td></tr> <tr><td>10-24</td><td>\$314.00</td></tr> <tr><td>25-49</td><td>\$304.18</td></tr> <tr><td>50+</td><td>\$297.64</td></tr> </tbody> </table> <p>2.92mm Male to 2.92mm Female Radius Right Angle VSWR 1.5:1 to 40 GHz</p> <p>Model No: PE91070</p>	PRICE	1-9	\$327.08	10-24	\$314.00	25-49	\$304.18	50+	\$297.64	 <table border="1"> <thead> <tr><th>PRICE</th></tr> </thead> <tbody> <tr><td>1-24</td><td>\$260.02</td></tr> <tr><td>25-49</td><td>\$241.82</td></tr> <tr><td>50-99</td><td>\$223.62</td></tr> <tr><td>100+</td><td>\$208.02</td></tr> </tbody> </table> <p>2.92mm Male to 3.5mm Male Right Angle VSWR 1.25:1 to 34.5 GHz</p> <p>Model No: PE91165</p>	PRICE	1-24	\$260.02	25-49	\$241.82	50-99	\$223.62	100+	\$208.02
	PRICE																																																	
1-9	\$161.34																																																	
10-24	\$153.27																																																	
25-49	\$145.21																																																	
50+	\$138.75																																																	
PRICE																																																		
1-9	\$237.13																																																	
10-24	\$225.27																																																	
25-49	\$213.42																																																	
NEW 50+	\$203.93																																																	
PRICE																																																		
1-9	\$146.82																																																	
10-24	\$139.48																																																	
25-49	\$132.14																																																	
50+	\$126.27																																																	
PRICE																																																		
1-9	\$327.08																																																	
10-24	\$314.00																																																	
25-49	\$304.18																																																	
50+	\$297.64																																																	
PRICE																																																		
1-24	\$260.02																																																	
25-49	\$241.82																																																	
50-99	\$223.62																																																	
100+	\$208.02																																																	

ADAPTERS

See Adapter Locator on Pages 8-13

See Page 369 for Mounting Holes

Adapters

See Our Website For Current Pricing & Real-Time Stock Availability!

	A	B	C	D	E																																													
1	 <table border="1"> <thead> <tr><th>PRICE</th></tr> </thead> <tbody> <tr><td>1-24</td><td>\$260.02</td></tr> <tr><td>25-49</td><td>\$241.82</td></tr> <tr><td>50-99</td><td>\$223.62</td></tr> <tr><td>100+</td><td>\$208.02</td></tr> </tbody> </table> <p>2.92mm Male to 3.5mm Female Right Angle VSWR 1.25:1 to 34.5 GHz</p> <p>Model No: PE91168</p>	PRICE	1-24	\$260.02	25-49	\$241.82	50-99	\$223.62	100+	\$208.02	 <table border="1"> <thead> <tr><th>PRICE</th></tr> </thead> <tbody> <tr><td>1-9</td><td>\$444.80</td></tr> <tr><td>10-24</td><td>\$427.01</td></tr> <tr><td>25-49</td><td>\$413.66</td></tr> <tr><td>50+</td><td>\$404.77</td></tr> </tbody> </table> <p>2.92mm Male to 7mm Sexless VSWR 1.1:1 to 18 GHz</p> <p>Model No: PE9460</p>	PRICE	1-9	\$444.80	10-24	\$427.01	25-49	\$413.66	50+	\$404.77	 <table border="1"> <thead> <tr><th>PRICE</th></tr> </thead> <tbody> <tr><td>1-9</td><td>\$240.95</td></tr> <tr><td>10-24</td><td>\$231.31</td></tr> <tr><td>25-49</td><td>\$224.08</td></tr> <tr><td>50+</td><td>\$219.26</td></tr> </tbody> </table> <p>2.92mm Male to Mini SMP Male VSWR 1.25:1 to 40 GHz</p> <p>Model No: PE91124</p>	PRICE	1-9	\$240.95	10-24	\$231.31	25-49	\$224.08	50+	\$219.26	 <table border="1"> <thead> <tr><th>PRICE</th></tr> </thead> <tbody> <tr><td>1-9</td><td>\$240.95</td></tr> <tr><td>10-24</td><td>\$231.31</td></tr> <tr><td>25-49</td><td>\$224.08</td></tr> <tr><td>50+</td><td>\$219.26</td></tr> </tbody> </table> <p>2.92mm Male to Smooth Bore Mini SMP Male VSWR 1.4:1 to 40 GHz</p> <p>Model No: PE91125</p>	PRICE	1-9	\$240.95	10-24	\$231.31	25-49	\$224.08	50+	\$219.26	 <table border="1"> <thead> <tr><th>PRICE</th></tr> </thead> <tbody> <tr><td>1-9</td><td>\$240.95</td></tr> <tr><td>10-24</td><td>\$231.31</td></tr> <tr><td>25-49</td><td>\$224.08</td></tr> <tr><td>50+</td><td>\$219.26</td></tr> </tbody> </table> <p>2.92mm Male to Mini SMP Female VSWR 1.4:1 to 40 GHz</p> <p>Model No: PE91126</p>	PRICE	1-9	\$240.95	10-24	\$231.31	25-49	\$224.08	50+	\$219.26
PRICE																																																		
1-24	\$260.02																																																	
25-49	\$241.82																																																	
50-99	\$223.62																																																	
100+	\$208.02																																																	
PRICE																																																		
1-9	\$444.80																																																	
10-24	\$427.01																																																	
25-49	\$413.66																																																	
50+	\$404.77																																																	
PRICE																																																		
1-9	\$240.95																																																	
10-24	\$231.31																																																	
25-49	\$224.08																																																	
50+	\$219.26																																																	
PRICE																																																		
1-9	\$240.95																																																	
10-24	\$231.31																																																	
25-49	\$224.08																																																	
50+	\$219.26																																																	
PRICE																																																		
1-9	\$240.95																																																	
10-24	\$231.31																																																	
25-49	\$224.08																																																	
50+	\$219.26																																																	
2	 <table border="1"> <thead> <tr><th>PRICE</th></tr> </thead> <tbody> <tr><td>1-9</td><td>\$241.72</td></tr> <tr><td>10-24</td><td>\$229.63</td></tr> <tr><td>25-49</td><td>\$217.55</td></tr> <tr><td>50+</td><td>\$207.88</td></tr> </tbody> </table> <p>PRECISION 2.92mm Male to N Male VSWR 1.15:1 to 18 GHz</p> <p>Model No: PE9661</p>	PRICE	1-9	\$241.72	10-24	\$229.63	25-49	\$217.55	50+	\$207.88	 <table border="1"> <thead> <tr><th>PRICE</th></tr> </thead> <tbody> <tr><td>1-9</td><td>\$329.98</td></tr> <tr><td>10-24</td><td>\$313.48</td></tr> <tr><td>25-49</td><td>\$296.98</td></tr> <tr><td>50+</td><td>\$283.78</td></tr> </tbody> </table> <p>PRECISION 2.92mm Male to N Female VSWR 1.15:1 to 18 GHz</p> <p>Model No: PE9662</p>	PRICE	1-9	\$329.98	10-24	\$313.48	25-49	\$296.98	50+	\$283.78	 <table border="1"> <thead> <tr><th>PRICE</th></tr> </thead> <tbody> <tr><td>1-4</td><td>\$602.60</td></tr> <tr><td>5-9</td><td>\$572.47</td></tr> <tr><td>10-24</td><td>\$542.34</td></tr> <tr><td>25+</td><td>\$518.24</td></tr> </tbody> </table> <p>2.92mm Female to 1.85mm Male VSWR 1.25:1 to 40 GHz</p> <p>Model No: PE9665</p>	PRICE	1-4	\$602.60	5-9	\$572.47	10-24	\$542.34	25+	\$518.24	 <table border="1"> <thead> <tr><th>PRICE</th></tr> </thead> <tbody> <tr><td>1-4</td><td>\$525.39</td></tr> <tr><td>5-9</td><td>\$499.12</td></tr> <tr><td>10-24</td><td>\$472.85</td></tr> <tr><td>25+</td><td>\$451.84</td></tr> </tbody> </table> <p>2.92mm Female to 1.85mm Female VSWR 1.25:1 to 40 GHz</p> <p>Model No: PE9668</p>	PRICE	1-4	\$525.39	5-9	\$499.12	10-24	\$472.85	25+	\$451.84	 <table border="1"> <thead> <tr><th>PRICE</th></tr> </thead> <tbody> <tr><td>1-9</td><td>\$265.59</td></tr> <tr><td>10-24</td><td>\$252.31</td></tr> <tr><td>25-49</td><td>\$239.03</td></tr> <tr><td>50+</td><td>\$228.41</td></tr> </tbody> </table> <p>NEW 2.92mm Female to 2.4mm Male VSWR 1.25:1 to 40 GHz</p> <p>Model No: PE91451</p>	PRICE	1-9	\$265.59	10-24	\$252.31	25-49	\$239.03	50+	\$228.41
PRICE																																																		
1-9	\$241.72																																																	
10-24	\$229.63																																																	
25-49	\$217.55																																																	
50+	\$207.88																																																	
PRICE																																																		
1-9	\$329.98																																																	
10-24	\$313.48																																																	
25-49	\$296.98																																																	
50+	\$283.78																																																	
PRICE																																																		
1-4	\$602.60																																																	
5-9	\$572.47																																																	
10-24	\$542.34																																																	
25+	\$518.24																																																	
PRICE																																																		
1-4	\$525.39																																																	
5-9	\$499.12																																																	
10-24	\$472.85																																																	
25+	\$451.84																																																	
PRICE																																																		
1-9	\$265.59																																																	
10-24	\$252.31																																																	
25-49	\$239.03																																																	
50+	\$228.41																																																	
3	 <table border="1"> <thead> <tr><th>PRICE</th></tr> </thead> <tbody> <tr><td>1-9</td><td>\$138.53</td></tr> <tr><td>10-24</td><td>\$131.60</td></tr> <tr><td>25-49</td><td>\$124.68</td></tr> <tr><td>50+</td><td>\$119.14</td></tr> </tbody> </table> <p>2.92mm Female to 2.4mm Male VSWR 1.25:1 to 40 GHz</p> <p>Model No: PE9454</p>	PRICE	1-9	\$138.53	10-24	\$131.60	25-49	\$124.68	50+	\$119.14	 <table border="1"> <thead> <tr><th>PRICE</th></tr> </thead> <tbody> <tr><td>1-9</td><td>\$237.13</td></tr> <tr><td>10-24</td><td>\$225.27</td></tr> <tr><td>25-49</td><td>\$213.42</td></tr> <tr><td>50+</td><td>\$203.93</td></tr> </tbody> </table> <p>2.92mm Female to 2.4mm Female VSWR 1.15:1 to 40 GHz</p> <p>Model No: PE91295</p>	PRICE	1-9	\$237.13	10-24	\$225.27	25-49	\$213.42	50+	\$203.93	 <table border="1"> <thead> <tr><th>PRICE</th></tr> </thead> <tbody> <tr><td>1-24</td><td>\$237.13</td></tr> <tr><td>25-49</td><td>\$220.53</td></tr> <tr><td>50-99</td><td>\$203.93</td></tr> <tr><td>100+</td><td>\$189.70</td></tr> </tbody> </table> <p>NEW 2.92mm Female to 2.4mm Female VSWR 1.2:1 to 40 GHz</p> <p>Model No: PE91499</p>	PRICE	1-24	\$237.13	25-49	\$220.53	50-99	\$203.93	100+	\$189.70	 <table border="1"> <thead> <tr><th>PRICE</th></tr> </thead> <tbody> <tr><td>1-9</td><td>\$152.42</td></tr> <tr><td>10-24</td><td>\$144.80</td></tr> <tr><td>25-49</td><td>\$137.18</td></tr> <tr><td>50+</td><td>\$131.08</td></tr> </tbody> </table> <p>2.92mm Female to 2.4mm Female VSWR 1.3:1 to 40 GHz</p> <p>Model No: PE9456</p>	PRICE	1-9	\$152.42	10-24	\$144.80	25-49	\$137.18	50+	\$131.08	 <table border="1"> <thead> <tr><th>PRICE</th></tr> </thead> <tbody> <tr><td>1-24</td><td>\$260.02</td></tr> <tr><td>25-49</td><td>\$241.82</td></tr> <tr><td>50-99</td><td>\$223.62</td></tr> <tr><td>100+</td><td>\$208.02</td></tr> </tbody> </table> <p>2.92mm Female to 3.5mm Male Right Angle VSWR 1.25:1 to 34.5 GHz</p> <p>Model No: PE91166</p>	PRICE	1-24	\$260.02	25-49	\$241.82	50-99	\$223.62	100+	\$208.02
PRICE																																																		
1-9	\$138.53																																																	
10-24	\$131.60																																																	
25-49	\$124.68																																																	
50+	\$119.14																																																	
PRICE																																																		
1-9	\$237.13																																																	
10-24	\$225.27																																																	
25-49	\$213.42																																																	
50+	\$203.93																																																	
PRICE																																																		
1-24	\$237.13																																																	
25-49	\$220.53																																																	
50-99	\$203.93																																																	
100+	\$189.70																																																	
PRICE																																																		
1-9	\$152.42																																																	
10-24	\$144.80																																																	
25-49	\$137.18																																																	
50+	\$131.08																																																	
PRICE																																																		
1-24	\$260.02																																																	
25-49	\$241.82																																																	
50-99	\$223.62																																																	
100+	\$208.02																																																	
4	 <table border="1"> <thead> <tr><th>PRICE</th></tr> </thead> <tbody> <tr><td>1-9</td><td>\$220.01</td></tr> <tr><td>10-24</td><td>\$209.01</td></tr> <tr><td>25-49</td><td>\$198.01</td></tr> <tr><td>50+</td><td>\$189.21</td></tr> </tbody> </table> <p>2.92mm Female to 3.5mm Female VSWR 1.25:1 to 34 GHz</p> <p>Model No: PE9660</p>	PRICE	1-9	\$220.01	10-24	\$209.01	25-49	\$198.01	50+	\$189.21	 <table border="1"> <thead> <tr><th>PRICE</th></tr> </thead> <tbody> <tr><td>1-24</td><td>\$232.15</td></tr> <tr><td>25-49</td><td>\$215.90</td></tr> <tr><td>50-99</td><td>\$199.65</td></tr> <tr><td>100+</td><td>\$185.72</td></tr> </tbody> </table> <p>2.92mm Female to 3.5mm Female Right Angle VSWR 1.25:1 to 34.5 GHz</p> <p>Model No: PE91167</p>	PRICE	1-24	\$232.15	25-49	\$215.90	50-99	\$199.65	100+	\$185.72	 <table border="1"> <thead> <tr><th>PRICE</th></tr> </thead> <tbody> <tr><td>1-9</td><td>\$498.18</td></tr> <tr><td>10-24</td><td>\$473.27</td></tr> <tr><td>25-49</td><td>\$448.36</td></tr> <tr><td>50+</td><td>\$428.43</td></tr> </tbody> </table> <p>PRECISION 2.92mm Female to 7mm Sexless VSWR 1.1:1 to 18 GHz</p> <p>Model No: PE9461</p>	PRICE	1-9	\$498.18	10-24	\$473.27	25-49	\$448.36	50+	\$428.43	 <table border="1"> <thead> <tr><th>PRICE</th></tr> </thead> <tbody> <tr><td>1-4</td><td>\$642.09</td></tr> <tr><td>5-9</td><td>\$609.99</td></tr> <tr><td>10-24</td><td>\$577.88</td></tr> <tr><td>25+</td><td>\$552.20</td></tr> </tbody> </table> <p>2.92mm Female to Mini SMP Male VSWR 1.3:1 to 40 GHz</p> <p>Model No: PE9781</p>	PRICE	1-4	\$642.09	5-9	\$609.99	10-24	\$577.88	25+	\$552.20	 <table border="1"> <thead> <tr><th>PRICE</th></tr> </thead> <tbody> <tr><td>1-9</td><td>\$240.95</td></tr> <tr><td>10-24</td><td>\$231.31</td></tr> <tr><td>25-49</td><td>\$224.08</td></tr> <tr><td>50+</td><td>\$219.26</td></tr> </tbody> </table> <p>2.92mm Female to Full Detent Mini SMP Male VSWR 1.35:1 to 40 GHz</p> <p>Model No: PE91127</p>	PRICE	1-9	\$240.95	10-24	\$231.31	25-49	\$224.08	50+	\$219.26
PRICE																																																		
1-9	\$220.01																																																	
10-24	\$209.01																																																	
25-49	\$198.01																																																	
50+	\$189.21																																																	
PRICE																																																		
1-24	\$232.15																																																	
25-49	\$215.90																																																	
50-99	\$199.65																																																	
100+	\$185.72																																																	
PRICE																																																		
1-9	\$498.18																																																	
10-24	\$473.27																																																	
25-49	\$448.36																																																	
50+	\$428.43																																																	
PRICE																																																		
1-4	\$642.09																																																	
5-9	\$609.99																																																	
10-24	\$577.88																																																	
25+	\$552.20																																																	
PRICE																																																		
1-9	\$240.95																																																	
10-24	\$231.31																																																	
25-49	\$224.08																																																	
50+	\$219.26																																																	
5	 <table border="1"> <thead> <tr><th>PRICE</th></tr> </thead> <tbody> <tr><td>1-9</td><td>\$262.77</td></tr> <tr><td>10-24</td><td>\$252.26</td></tr> <tr><td>25-49</td><td>\$244.38</td></tr> <tr><td>50+</td><td>\$239.12</td></tr> </tbody> </table> <p>2.92mm Female to Smooth Bore Mini SMP Male VSWR 1.35:1 to 40 GHz</p> <p>Model No: PE91128</p>	PRICE	1-9	\$262.77	10-24	\$252.26	25-49	\$244.38	50+	\$239.12	 <table border="1"> <thead> <tr><th>PRICE</th></tr> </thead> <tbody> <tr><td>1-4</td><td>\$742.40</td></tr> <tr><td>5-9</td><td>\$705.28</td></tr> <tr><td>10-24</td><td>\$668.16</td></tr> <tr><td>25+</td><td>\$638.46</td></tr> </tbody> </table> <p>2.92mm Female to Mini SMP Female VSWR 1.3:1 to 40 GHz</p> <p>Model No: PE9782</p>	PRICE	1-4	\$742.40	5-9	\$705.28	10-24	\$668.16	25+	\$638.46	 <table border="1"> <thead> <tr><th>PRICE</th></tr> </thead> <tbody> <tr><td>1-9</td><td>\$218.62</td></tr> <tr><td>10-24</td><td>\$207.69</td></tr> <tr><td>25-49</td><td>\$196.76</td></tr> <tr><td>50+</td><td>\$188.01</td></tr> </tbody> </table> <p>PRECISION 2.92mm Female to N Male VSWR 1.15:1 to 18 GHz</p> <p>Model No: PE9663</p>	PRICE	1-9	\$218.62	10-24	\$207.69	25-49	\$196.76	50+	\$188.01	 <table border="1"> <thead> <tr><th>PRICE</th></tr> </thead> <tbody> <tr><td>1-9</td><td>\$222.42</td></tr> <tr><td>10-24</td><td>\$211.30</td></tr> <tr><td>25-49</td><td>\$200.18</td></tr> <tr><td>50+</td><td>\$191.28</td></tr> </tbody> </table> <p>PRECISION 2.92mm Female to N Female VSWR 1.15:1 to 18 GHz</p> <p>Model No: PE9664</p>	PRICE	1-9	\$222.42	10-24	\$211.30	25-49	\$200.18	50+	\$191.28	 <table border="1"> <thead> <tr><th>PRICE</th></tr> </thead> <tbody> <tr><td>1-9</td><td>\$213.57</td></tr> <tr><td>10-24</td><td>\$202.89</td></tr> <tr><td>25-49</td><td>\$192.21</td></tr> <tr><td>50+</td><td>\$183.67</td></tr> </tbody> </table> <p>2.92mm Female to SMP Female VSWR 1.25:1 to 40 GHz</p> <p>Model No: PE91060</p>	PRICE	1-9	\$213.57	10-24	\$202.89	25-49	\$192.21	50+	\$183.67
PRICE																																																		
1-9	\$262.77																																																	
10-24	\$252.26																																																	
25-49	\$244.38																																																	
50+	\$239.12																																																	
PRICE																																																		
1-4	\$742.40																																																	
5-9	\$705.28																																																	
10-24	\$668.16																																																	
25+	\$638.46																																																	
PRICE																																																		
1-9	\$218.62																																																	
10-24	\$207.69																																																	
25-49	\$196.76																																																	
50+	\$188.01																																																	
PRICE																																																		
1-9	\$222.42																																																	
10-24	\$211.30																																																	
25-49	\$200.18																																																	
50+	\$191.28																																																	
PRICE																																																		
1-9	\$213.57																																																	
10-24	\$202.89																																																	
25-49	\$192.21																																																	
50+	\$183.67																																																	
6	 <table border="1"> <thead> <tr><th>PRICE</th></tr> </thead> <tbody> <tr><td>1-9</td><td>\$217.58</td></tr> <tr><td>10-24</td><td>\$206.70</td></tr> <tr><td>25-49</td><td>\$195.82</td></tr> <tr><td>50+</td><td>\$187.12</td></tr> </tbody> </table> <p>2.92mm Female to SSMA Male VSWR 1.25:1 to 40 GHz</p> <p>Model No: PE9768</p>	PRICE	1-9	\$217.58	10-24	\$206.70	25-49	\$195.82	50+	\$187.12	<p>3.5mm In-Series</p> <p>→</p>		 <table border="1"> <thead> <tr><th>PRICE</th></tr> </thead> <tbody> <tr><td>1-9</td><td>\$191.44</td></tr> <tr><td>10-24</td><td>\$181.87</td></tr> <tr><td>25-49</td><td>\$172.30</td></tr> <tr><td>50+</td><td>\$164.64</td></tr> </tbody> </table> <p>3.5mm Male to 3.5mm Male VSWR 1.25:1 to 34.5 GHz</p> <p>Model No: PE9330</p>	PRICE	1-9	\$191.44	10-24	\$181.87	25-49	\$172.30	50+	\$164.64	 <table border="1"> <thead> <tr><th>PRICE</th></tr> </thead> <tbody> <tr><td>1-24</td><td>\$260.02</td></tr> <tr><td>25-49</td><td>\$241.82</td></tr> <tr><td>50-99</td><td>\$223.62</td></tr> <tr><td>100+</td><td>\$208.02</td></tr> </tbody> </table> <p>3.5mm Male to 3.5mm Male Right Angle VSWR 1.25:1 to 34.5 GHz</p> <p>Model No: PE91169</p>	PRICE	1-24	\$260.02	25-49	\$241.82	50-99	\$223.62	100+	\$208.02	 <table border="1"> <thead> <tr><th>PRICE</th></tr> </thead> <tbody> <tr><td>1-9</td><td>\$191.44</td></tr> <tr><td>10-24</td><td>\$181.87</td></tr> <tr><td>25-49</td><td>\$172.30</td></tr> <tr><td>50+</td><td>\$164.64</td></tr> </tbody> </table> <p>3.5mm Male to 3.5mm Female VSWR 1.25:1 to 34.5 GHz</p> <p>Model No: PE9332</p>	PRICE	1-9	\$191.44	10-24	\$181.87	25-49	\$172.30	50+	\$164.64								
PRICE																																																		
1-9	\$217.58																																																	
10-24	\$206.70																																																	
25-49	\$195.82																																																	
50+	\$187.12																																																	
PRICE																																																		
1-9	\$191.44																																																	
10-24	\$181.87																																																	
25-49	\$172.30																																																	
50+	\$164.64																																																	
PRICE																																																		
1-24	\$260.02																																																	
25-49	\$241.82																																																	
50-99	\$223.62																																																	
100+	\$208.02																																																	
PRICE																																																		
1-9	\$191.44																																																	
10-24	\$181.87																																																	
25-49	\$172.30																																																	
50+	\$164.64																																																	
7	 <table border="1"> <thead> <tr><th>PRICE</th></tr> </thead> <tbody> <tr><td>1-9</td><td>\$154.96</td></tr> <tr><td>10-24</td><td>\$147.21</td></tr> <tr><td>25-49</td><td>\$139.46</td></tr> <tr><td>50+</td><td>\$133.27</td></tr> </tbody> </table> <p>3.5mm Female to 3.5mm Female VSWR 1.25:1 to 34.5 GHz</p> <p>Model No: PE9331</p>	PRICE	1-9	\$154.96	10-24	\$147.21	25-49	\$139.46	50+	\$133.27	 <table border="1"> <thead> <tr><th>PRICE</th></tr> </thead> <tbody> <tr><td>1-9</td><td>\$171.19</td></tr> <tr><td>10-24</td><td>\$162.63</td></tr> <tr><td>25-49</td><td>\$154.07</td></tr> <tr><td>50+</td><td>\$147.22</td></tr> </tbody> </table> <p>3.5mm Female to 3.5mm Female Bulkhead-Mounting Hole B06 VSWR 1.25:1 to 34.5 GHz</p> <p>Model No: PE9678</p>	PRICE	1-9	\$171.19	10-24	\$162.63	25-49	\$154.07	50+	\$147.22	 <table border="1"> <thead> <tr><th>PRICE</th></tr> </thead> <tbody> <tr><td>1-9</td><td>\$233.47</td></tr> <tr><td>10-24</td><td>\$221.80</td></tr> <tr><td>25-49</td><td>\$210.12</td></tr> <tr><td>50+</td><td>\$200.78</td></tr> </tbody> </table> <p>3.5mm Female to 3.5mm Female 4 Hole Flange-Mounting Hole A01 VSWR 1.25:1 to 34.5 GHz</p> <p>Model No: PE9676</p>	PRICE	1-9	\$233.47	10-24	\$221.80	25-49	\$210.12	50+	\$200.78	<p>3.5mm Between Series</p> <p>→</p>		 <table border="1"> <thead> <tr><th>PRICE</th></tr> </thead> <tbody> <tr><td>1-9</td><td>\$223.14</td></tr> <tr><td>10-24</td><td>\$211.98</td></tr> <tr><td>25-49</td><td>\$200.83</td></tr> <tr><td>50+</td><td>\$191.90</td></tr> </tbody> </table> <p>3.5mm Male to 1.85mm Male VSWR 1.3:1 to 34 GHz</p> <p>Model No: PE9746</p>	PRICE	1-9	\$223.14	10-24	\$211.98	25-49	\$200.83	50+	\$191.90								
PRICE																																																		
1-9	\$154.96																																																	
10-24	\$147.21																																																	
25-49	\$139.46																																																	
50+	\$133.27																																																	
PRICE																																																		
1-9	\$171.19																																																	
10-24	\$162.63																																																	
25-49	\$154.07																																																	
50+	\$147.22																																																	
PRICE																																																		
1-9	\$233.47																																																	
10-24	\$221.80																																																	
25-49	\$210.12																																																	
50+	\$200.78																																																	
PRICE																																																		
1-9	\$223.14																																																	
10-24	\$211.98																																																	
25-49	\$200.83																																																	
50+	\$191.90																																																	

ADAPTERS

See Adapter Locator on Pages 8-13

See Page 369 for Mounting Holes

Adapters

See Our Website For Current Pricing & Real-Time Stock Availability!

	A	B	C	D	E																																													
1	 <table border="1"> <thead> <tr><th>PRICE</th></tr></thead> <tbody> <tr><td>1-9</td><td>\$223.14</td></tr> <tr><td>10-24</td><td>\$211.98</td></tr> <tr><td>25-49</td><td>\$200.83</td></tr> <tr><td>50+</td><td>\$191.90</td></tr> </tbody> </table> <p>3.5mm Male to 1.85mm Female VSWR 1.3:1 to 34 GHz Model No: PE9745</p>	PRICE	1-9	\$223.14	10-24	\$211.98	25-49	\$200.83	50+	\$191.90	 <table border="1"> <thead> <tr><th>PRICE</th></tr></thead> <tbody> <tr><td>1-9</td><td>\$271.40</td></tr> <tr><td>10-24</td><td>\$257.83</td></tr> <tr><td>25-49</td><td>\$244.26</td></tr> <tr><td>50+</td><td>\$233.40</td></tr> </tbody> </table> <p>3.5mm Male to 2.4mm Male VSWR 1.15:1 to 34 GHz Model No: PE91294</p>	PRICE	1-9	\$271.40	10-24	\$257.83	25-49	\$244.26	50+	\$233.40	 <table border="1"> <thead> <tr><th>PRICE</th></tr></thead> <tbody> <tr><td>1-9</td><td>\$216.37</td></tr> <tr><td>10-24</td><td>\$205.55</td></tr> <tr><td>25-49</td><td>\$194.73</td></tr> <tr><td>50+</td><td>\$186.08</td></tr> </tbody> </table> <p>3.5mm Male to 2.4mm Male VSWR 1.25:1 to 34 GHz Model No: PE9649</p>	PRICE	1-9	\$216.37	10-24	\$205.55	25-49	\$194.73	50+	\$186.08	 <table border="1"> <thead> <tr><th>PRICE</th></tr></thead> <tbody> <tr><td>1-9</td><td>\$216.37</td></tr> <tr><td>10-24</td><td>\$205.55</td></tr> <tr><td>25-49</td><td>\$194.73</td></tr> <tr><td>50+</td><td>\$186.08</td></tr> </tbody> </table> <p>3.5mm Male to 2.4mm Female VSWR 1.25:1 to 34 GHz Model No: PE9651</p>	PRICE	1-9	\$216.37	10-24	\$205.55	25-49	\$194.73	50+	\$186.08	 <table border="1"> <thead> <tr><th>PRICE</th></tr></thead> <tbody> <tr><td>1-9</td><td>\$220.01</td></tr> <tr><td>10-24</td><td>\$209.01</td></tr> <tr><td>25-49</td><td>\$198.01</td></tr> <tr><td>50+</td><td>\$189.21</td></tr> </tbody> </table> <p>3.5mm Male to 2.92mm Female VSWR 1.25:1 to 34 GHz Model No: PE9658</p>	PRICE	1-9	\$220.01	10-24	\$209.01	25-49	\$198.01	50+	\$189.21
PRICE																																																		
1-9	\$223.14																																																	
10-24	\$211.98																																																	
25-49	\$200.83																																																	
50+	\$191.90																																																	
PRICE																																																		
1-9	\$271.40																																																	
10-24	\$257.83																																																	
25-49	\$244.26																																																	
50+	\$233.40																																																	
PRICE																																																		
1-9	\$216.37																																																	
10-24	\$205.55																																																	
25-49	\$194.73																																																	
50+	\$186.08																																																	
PRICE																																																		
1-9	\$216.37																																																	
10-24	\$205.55																																																	
25-49	\$194.73																																																	
50+	\$186.08																																																	
PRICE																																																		
1-9	\$220.01																																																	
10-24	\$209.01																																																	
25-49	\$198.01																																																	
50+	\$189.21																																																	
2	 <table border="1"> <thead> <tr><th>PRICE</th></tr></thead> <tbody> <tr><td>1-9</td><td>\$305.82</td></tr> <tr><td>10-24</td><td>\$290.53</td></tr> <tr><td>25-49</td><td>\$275.24</td></tr> <tr><td>50+</td><td>\$263.01</td></tr> </tbody> </table> <p>PRECISION 3.5mm Male to 7mm Sexless VSWR 1.15:1 to 18 GHz Model No: PE9326</p>	PRICE	1-9	\$305.82	10-24	\$290.53	25-49	\$275.24	50+	\$263.01	 <table border="1"> <thead> <tr><th>PRICE</th></tr></thead> <tbody> <tr><td>1-9</td><td>\$185.77</td></tr> <tr><td>10-24</td><td>\$176.48</td></tr> <tr><td>25-49</td><td>\$167.19</td></tr> <tr><td>50+</td><td>\$159.76</td></tr> </tbody> </table> <p>PRECISION 3.5mm Male to N Male VSWR 1.15:1 to 18 GHz Model No: PE9322</p>	PRICE	1-9	\$185.77	10-24	\$176.48	25-49	\$167.19	50+	\$159.76	 <table border="1"> <thead> <tr><th>PRICE</th></tr></thead> <tbody> <tr><td>1-9</td><td>\$179.14</td></tr> <tr><td>10-24</td><td>\$170.18</td></tr> <tr><td>25-49</td><td>\$161.23</td></tr> <tr><td>50+</td><td>\$154.06</td></tr> </tbody> </table> <p>PRECISION 3.5mm Male to N Female VSWR 1.15:1 to 18 GHz Model No: PE9324</p>	PRICE	1-9	\$179.14	10-24	\$170.18	25-49	\$161.23	50+	\$154.06	 <table border="1"> <thead> <tr><th>PRICE</th></tr></thead> <tbody> <tr><td>1-9</td><td>\$217.17</td></tr> <tr><td>10-24</td><td>\$206.31</td></tr> <tr><td>25-49</td><td>\$195.45</td></tr> <tr><td>50+</td><td>\$186.77</td></tr> </tbody> </table> <p>3.5mm Female to 1.85mm Female VSWR 1.3:1 to 34 GHz Model No: PE9748</p>	PRICE	1-9	\$217.17	10-24	\$206.31	25-49	\$195.45	50+	\$186.77	 <table border="1"> <thead> <tr><th>PRICE</th></tr></thead> <tbody> <tr><td>1-9</td><td>\$271.40</td></tr> <tr><td>10-24</td><td>\$257.83</td></tr> <tr><td>25-49</td><td>\$244.26</td></tr> <tr><td>50+</td><td>\$233.40</td></tr> </tbody> </table> <p>3.5mm Female to 2.4mm Male VSWR 1.25:1 to 34 GHz Model No: PE91292</p>	PRICE	1-9	\$271.40	10-24	\$257.83	25-49	\$244.26	50+	\$233.40
PRICE																																																		
1-9	\$305.82																																																	
10-24	\$290.53																																																	
25-49	\$275.24																																																	
50+	\$263.01																																																	
PRICE																																																		
1-9	\$185.77																																																	
10-24	\$176.48																																																	
25-49	\$167.19																																																	
50+	\$159.76																																																	
PRICE																																																		
1-9	\$179.14																																																	
10-24	\$170.18																																																	
25-49	\$161.23																																																	
50+	\$154.06																																																	
PRICE																																																		
1-9	\$217.17																																																	
10-24	\$206.31																																																	
25-49	\$195.45																																																	
50+	\$186.77																																																	
PRICE																																																		
1-9	\$271.40																																																	
10-24	\$257.83																																																	
25-49	\$244.26																																																	
50+	\$233.40																																																	
3	 <table border="1"> <thead> <tr><th>PRICE</th></tr></thead> <tbody> <tr><td>1-9</td><td>\$220.96</td></tr> <tr><td>10-24</td><td>\$209.91</td></tr> <tr><td>25-49</td><td>\$198.86</td></tr> <tr><td>50+</td><td>\$190.03</td></tr> </tbody> </table> <p>3.5mm Female to 2.4mm Male VSWR 1.25:1 to 34 GHz Model No: PE9650</p>	PRICE	1-9	\$220.96	10-24	\$209.91	25-49	\$198.86	50+	\$190.03	 <table border="1"> <thead> <tr><th>PRICE</th></tr></thead> <tbody> <tr><td>1-9</td><td>\$271.40</td></tr> <tr><td>10-24</td><td>\$257.83</td></tr> <tr><td>25-49</td><td>\$244.26</td></tr> <tr><td>50+</td><td>\$233.40</td></tr> </tbody> </table> <p>3.5mm Female to 2.4mm Female VSWR 1.15:1 to 34 GHz Model No: PE91291</p>	PRICE	1-9	\$271.40	10-24	\$257.83	25-49	\$244.26	50+	\$233.40	 <table border="1"> <thead> <tr><th>PRICE</th></tr></thead> <tbody> <tr><td>1-9</td><td>\$194.30</td></tr> <tr><td>10-24</td><td>\$184.59</td></tr> <tr><td>25-49</td><td>\$174.87</td></tr> <tr><td>50+</td><td>\$167.10</td></tr> </tbody> </table> <p>3.5mm Female to 2.4mm Female VSWR 1.25:1 to 34 GHz Model No: PE9652</p>	PRICE	1-9	\$194.30	10-24	\$184.59	25-49	\$174.87	50+	\$167.10	 <table border="1"> <thead> <tr><th>PRICE</th></tr></thead> <tbody> <tr><td>1-9</td><td>\$216.37</td></tr> <tr><td>10-24</td><td>\$205.55</td></tr> <tr><td>25-49</td><td>\$194.73</td></tr> <tr><td>50+</td><td>\$186.08</td></tr> </tbody> </table> <p>3.5mm Female to 2.92mm Male VSWR 1.25:1 to 34.5 GHz Model No: PE9659</p>	PRICE	1-9	\$216.37	10-24	\$205.55	25-49	\$194.73	50+	\$186.08	 <table border="1"> <thead> <tr><th>PRICE</th></tr></thead> <tbody> <tr><td>1-9</td><td>\$433.54</td></tr> <tr><td>10-24</td><td>\$411.86</td></tr> <tr><td>25-49</td><td>\$390.19</td></tr> <tr><td>50+</td><td>\$372.84</td></tr> </tbody> </table> <p>PRECISION 3.5mm Female to 7mm Sexless VSWR 1.15:1 to 18 GHz Model No: PE9325</p>	PRICE	1-9	\$433.54	10-24	\$411.86	25-49	\$390.19	50+	\$372.84
PRICE																																																		
1-9	\$220.96																																																	
10-24	\$209.91																																																	
25-49	\$198.86																																																	
50+	\$190.03																																																	
PRICE																																																		
1-9	\$271.40																																																	
10-24	\$257.83																																																	
25-49	\$244.26																																																	
50+	\$233.40																																																	
PRICE																																																		
1-9	\$194.30																																																	
10-24	\$184.59																																																	
25-49	\$174.87																																																	
50+	\$167.10																																																	
PRICE																																																		
1-9	\$216.37																																																	
10-24	\$205.55																																																	
25-49	\$194.73																																																	
50+	\$186.08																																																	
PRICE																																																		
1-9	\$433.54																																																	
10-24	\$411.86																																																	
25-49	\$390.19																																																	
50+	\$372.84																																																	
4	 <table border="1"> <thead> <tr><th>PRICE</th></tr></thead> <tbody> <tr><td>1-9</td><td>\$174.54</td></tr> <tr><td>10-24</td><td>\$165.81</td></tr> <tr><td>25-49</td><td>\$157.09</td></tr> <tr><td>50+</td><td>\$150.10</td></tr> </tbody> </table> <p>PRECISION 3.5mm Female to N Male VSWR 1.15:1 to 18 GHz Model No: PE9321</p>	PRICE	1-9	\$174.54	10-24	\$165.81	25-49	\$157.09	50+	\$150.10	 <table border="1"> <thead> <tr><th>PRICE</th></tr></thead> <tbody> <tr><td>1-9</td><td>\$176.74</td></tr> <tr><td>10-24</td><td>\$167.90</td></tr> <tr><td>25-49</td><td>\$159.07</td></tr> <tr><td>50+</td><td>\$152.00</td></tr> </tbody> </table> <p>PRECISION 3.5mm Female to N Female VSWR 1.15:1 to 18 GHz Model No: PE9323</p>	PRICE	1-9	\$176.74	10-24	\$167.90	25-49	\$159.07	50+	\$152.00	<p>3.5mm NMD Between Series</p> <p>→</p>		 <table border="1"> <thead> <tr><th>PRICE</th></tr></thead> <tbody> <tr><td>1-9</td><td>\$334.04</td></tr> <tr><td>10-24</td><td>\$317.34</td></tr> <tr><td>25-49</td><td>\$300.64</td></tr> <tr><td>50+</td><td>\$287.27</td></tr> </tbody> </table> <p>3.5mm NMD Female to 2.4mm Female VSWR 1.25:1 to 33 GHz Model No: PE91148</p>	PRICE	1-9	\$334.04	10-24	\$317.34	25-49	\$300.64	50+	\$287.27	 <table border="1"> <thead> <tr><th>PRICE</th></tr></thead> <tbody> <tr><td>1-9</td><td>\$301.25</td></tr> <tr><td>10-24</td><td>\$286.19</td></tr> <tr><td>25-49</td><td>\$271.13</td></tr> <tr><td>50+</td><td>\$259.08</td></tr> </tbody> </table> <p>Ruggedized 3.5mm NMD Female to SMA Female Max. Freq. 27 GHz Model No: PE91147</p>	PRICE	1-9	\$301.25	10-24	\$286.19	25-49	\$271.13	50+	\$259.08								
PRICE																																																		
1-9	\$174.54																																																	
10-24	\$165.81																																																	
25-49	\$157.09																																																	
50+	\$150.10																																																	
PRICE																																																		
1-9	\$176.74																																																	
10-24	\$167.90																																																	
25-49	\$159.07																																																	
50+	\$152.00																																																	
PRICE																																																		
1-9	\$334.04																																																	
10-24	\$317.34																																																	
25-49	\$300.64																																																	
50+	\$287.27																																																	
PRICE																																																		
1-9	\$301.25																																																	
10-24	\$286.19																																																	
25-49	\$271.13																																																	
50+	\$259.08																																																	
5	<p>7mm Between Series</p> <p>→</p>		 <table border="1"> <thead> <tr><th>PRICE</th></tr></thead> <tbody> <tr><td>1-9</td><td>\$485.03</td></tr> <tr><td>10-24</td><td>\$465.63</td></tr> <tr><td>25-49</td><td>\$451.08</td></tr> <tr><td>50+</td><td>\$441.38</td></tr> </tbody> </table> <p>PRECISION 7mm Sexless to BNC Male VSWR 1.15:1 to 8 GHz Model No: PE9221</p>	PRICE	1-9	\$485.03	10-24	\$465.63	25-49	\$451.08	50+	\$441.38	 <table border="1"> <thead> <tr><th>PRICE</th></tr></thead> <tbody> <tr><td>1-9</td><td>\$343.09</td></tr> <tr><td>10-24</td><td>\$325.94</td></tr> <tr><td>25-49</td><td>\$308.78</td></tr> <tr><td>50+</td><td>\$295.06</td></tr> </tbody> </table> <p>PRECISION 7mm Sexless to BNC Female VSWR 1.15:1 to 8 GHz Model No: PE9220</p>	PRICE	1-9	\$343.09	10-24	\$325.94	25-49	\$308.78	50+	\$295.06	<p>4.1/9.5 Mini DIN In-Series</p> <p>→</p>		 <table border="1"> <thead> <tr><th>PRICE</th></tr></thead> <tbody> <tr><td>1-24</td><td>\$65.21</td></tr> <tr><td>25-49</td><td>\$61.95</td></tr> <tr><td>50-99</td><td>\$58.69</td></tr> <tr><td>100+</td><td>\$56.08</td></tr> </tbody> </table> <p>4.1/9.5 Mini DIN Male to 4.1/9.5 Mini DIN Male VSWR 1.25:1 to 6 GHz Model No: PE91194</p>	PRICE	1-24	\$65.21	25-49	\$61.95	50-99	\$58.69	100+	\$56.08																
PRICE																																																		
1-9	\$485.03																																																	
10-24	\$465.63																																																	
25-49	\$451.08																																																	
50+	\$441.38																																																	
PRICE																																																		
1-9	\$343.09																																																	
10-24	\$325.94																																																	
25-49	\$308.78																																																	
50+	\$295.06																																																	
PRICE																																																		
1-24	\$65.21																																																	
25-49	\$61.95																																																	
50-99	\$58.69																																																	
100+	\$56.08																																																	
6	 <table border="1"> <thead> <tr><th>PRICE</th></tr></thead> <tbody> <tr><td>1-24</td><td>\$48.10</td></tr> <tr><td>25-49</td><td>\$45.70</td></tr> <tr><td>50-99</td><td>\$43.29</td></tr> <tr><td>100+</td><td>\$41.37</td></tr> </tbody> </table> <p>4.1/9.5 Mini DIN Male to 4.1/9.5 Mini DIN Male VSWR 1.3:1 to 6 GHz Model No: PE91231</p>	PRICE	1-24	\$48.10	25-49	\$45.70	50-99	\$43.29	100+	\$41.37	 <table border="1"> <thead> <tr><th>PRICE</th></tr></thead> <tbody> <tr><td>1-24</td><td>\$65.21</td></tr> <tr><td>25-49</td><td>\$61.95</td></tr> <tr><td>50-99</td><td>\$58.69</td></tr> <tr><td>100+</td><td>\$56.08</td></tr> </tbody> </table> <p>4.1/9.5 Mini DIN Male to 4.1/9.5 Mini DIN Female VSWR 1.25:1 to 6 GHz Model No: PE91195</p>	PRICE	1-24	\$65.21	25-49	\$61.95	50-99	\$58.69	100+	\$56.08	 <table border="1"> <thead> <tr><th>PRICE</th></tr></thead> <tbody> <tr><td>1-24</td><td>\$30.46</td></tr> <tr><td>25-49</td><td>\$28.94</td></tr> <tr><td>50-99</td><td>\$27.41</td></tr> <tr><td>100+</td><td>\$26.20</td></tr> </tbody> </table> <p>4.1/9.5 Mini DIN Male to 4.1/9.5 Mini DIN Female VSWR 1.3:1 to 6 GHz Model No: PE91232</p>	PRICE	1-24	\$30.46	25-49	\$28.94	50-99	\$27.41	100+	\$26.20	 <table border="1"> <thead> <tr><th>PRICE</th></tr></thead> <tbody> <tr><td>1-24</td><td>\$28.73</td></tr> <tr><td>25-49</td><td>\$27.29</td></tr> <tr><td>50-99</td><td>\$25.86</td></tr> <tr><td>100+</td><td>\$24.71</td></tr> </tbody> </table> <p>4.1/9.5 Mini DIN Female to 4.1/9.5 Mini DIN Female VSWR 1.3:1 to 6 GHz Model No: PE91233</p>	PRICE	1-24	\$28.73	25-49	\$27.29	50-99	\$25.86	100+	\$24.71	 <table border="1"> <thead> <tr><th>PRICE</th></tr></thead> <tbody> <tr><td>1-24</td><td>\$77.90</td></tr> <tr><td>25-49</td><td>\$74.01</td></tr> <tr><td>50-99</td><td>\$70.11</td></tr> <tr><td>100+</td><td>\$66.99</td></tr> </tbody> </table> <p>4.1/9.5 Mini DIN Female to 4.1/9.5 Mini DIN Female Bulkhead VSWR 1.25:1 to 6 GHz Model No: PE91197</p>	PRICE	1-24	\$77.90	25-49	\$74.01	50-99	\$70.11	100+	\$66.99
PRICE																																																		
1-24	\$48.10																																																	
25-49	\$45.70																																																	
50-99	\$43.29																																																	
100+	\$41.37																																																	
PRICE																																																		
1-24	\$65.21																																																	
25-49	\$61.95																																																	
50-99	\$58.69																																																	
100+	\$56.08																																																	
PRICE																																																		
1-24	\$30.46																																																	
25-49	\$28.94																																																	
50-99	\$27.41																																																	
100+	\$26.20																																																	
PRICE																																																		
1-24	\$28.73																																																	
25-49	\$27.29																																																	
50-99	\$25.86																																																	
100+	\$24.71																																																	
PRICE																																																		
1-24	\$77.90																																																	
25-49	\$74.01																																																	
50-99	\$70.11																																																	
100+	\$66.99																																																	
7	 <table border="1"> <thead> <tr><th>PRICE</th></tr></thead> <tbody> <tr><td>1-24</td><td>\$30.67</td></tr> <tr><td>25-49</td><td>\$29.14</td></tr> <tr><td>50-99</td><td>\$27.60</td></tr> <tr><td>100+</td><td>\$26.38</td></tr> </tbody> </table> <p>4.1/9.5 Mini DIN Female to 4.1/9.5 Mini DIN Female Bulkhead VSWR 1.3:1 to 6 GHz Model No: PE91234</p>	PRICE	1-24	\$30.67	25-49	\$29.14	50-99	\$27.60	100+	\$26.38	<p>4.1/9.5 Mini DIN Between Series</p> <p>→</p>		 <table border="1"> <thead> <tr><th>PRICE</th></tr></thead> <tbody> <tr><td>1-24</td><td>\$56.01</td></tr> <tr><td>25-49</td><td>\$53.21</td></tr> <tr><td>50-99</td><td>\$50.41</td></tr> <tr><td>100+</td><td>\$48.17</td></tr> </tbody> </table> <p>4.1/9.5 Mini DIN Male to N Male VSWR 1.25:1 to 6 GHz Model No: PE91216</p>	PRICE	1-24	\$56.01	25-49	\$53.21	50-99	\$50.41	100+	\$48.17	 <table border="1"> <thead> <tr><th>PRICE</th></tr></thead> <tbody> <tr><td>1-24</td><td>\$61.61</td></tr> <tr><td>25-49</td><td>\$58.53</td></tr> <tr><td>50-99</td><td>\$55.45</td></tr> <tr><td>100+</td><td>\$52.98</td></tr> </tbody> </table> <p>4.1/9.5 Mini DIN Male to N Male VSWR 1.3:1 to 6 GHz Model No: PE91253</p>	PRICE	1-24	\$61.61	25-49	\$58.53	50-99	\$55.45	100+	\$52.98	 <table border="1"> <thead> <tr><th>PRICE</th></tr></thead> <tbody> <tr><td>1-24</td><td>\$59.07</td></tr> <tr><td>25-49</td><td>\$56.12</td></tr> <tr><td>50-99</td><td>\$53.16</td></tr> <tr><td>100+</td><td>\$50.80</td></tr> </tbody> </table> <p>Low PIM 4.1/9.5 Mini DIN Male to N Male VSWR 1.25:1 to 6 GHz Model No: PE91092</p>	PRICE	1-24	\$59.07	25-49	\$56.12	50-99	\$53.16	100+	\$50.80								
PRICE																																																		
1-24	\$30.67																																																	
25-49	\$29.14																																																	
50-99	\$27.60																																																	
100+	\$26.38																																																	
PRICE																																																		
1-24	\$56.01																																																	
25-49	\$53.21																																																	
50-99	\$50.41																																																	
100+	\$48.17																																																	
PRICE																																																		
1-24	\$61.61																																																	
25-49	\$58.53																																																	
50-99	\$55.45																																																	
100+	\$52.98																																																	
PRICE																																																		
1-24	\$59.07																																																	
25-49	\$56.12																																																	
50-99	\$53.16																																																	
100+	\$50.80																																																	





ADAPTERS

See Adapter Locator on Pages 8-13

See Page 369 for Mounting Holes

Adapters

See Our Website For Current Pricing & Real-Time Stock Availability!

	A	B	C	D	E																																																		
1	 <table border="1"> <thead> <tr> <th colspan="2">PRICE</th> </tr> </thead> <tbody> <tr> <td>1-24</td> <td>\$61.62</td> </tr> <tr> <td>25-49</td> <td>\$58.54</td> </tr> <tr> <td>50-99</td> <td>\$55.46</td> </tr> <tr> <td>100+</td> <td>\$52.99</td> </tr> </tbody> </table> <p>4.1/9.5 Mini DIN Male to N Female VSWR 1.25:1 to 6 GHz Model No: PE91217</p>	PRICE		1-24	\$61.62	25-49	\$58.54	50-99	\$55.46	100+	\$52.99	 <table border="1"> <thead> <tr> <th colspan="2">PRICE</th> </tr> </thead> <tbody> <tr> <td>1-24</td> <td>\$64.01</td> </tr> <tr> <td>25-49</td> <td>\$60.81</td> </tr> <tr> <td>50-99</td> <td>\$57.61</td> </tr> <tr> <td>100+</td> <td>\$55.05</td> </tr> </tbody> </table> <p>4.1/9.5 Mini DIN Male to N Female VSWR 1.3:1 to 6 GHz Model No: PE91254</p>	PRICE		1-24	\$64.01	25-49	\$60.81	50-99	\$57.61	100+	\$55.05	 <table border="1"> <thead> <tr> <th colspan="2">PRICE</th> </tr> </thead> <tbody> <tr> <td>1-24</td> <td>\$57.46</td> </tr> <tr> <td>25-49</td> <td>\$54.59</td> </tr> <tr> <td>50-99</td> <td>\$51.71</td> </tr> <tr> <td>100+</td> <td>\$49.42</td> </tr> </tbody> </table> <p>Low PIM 4.1/9.5 Mini DIN Male to N Female VSWR 1.25:1 to 6 GHz Model No: PE91093</p>	PRICE		1-24	\$57.46	25-49	\$54.59	50-99	\$51.71	100+	\$49.42	 <table border="1"> <thead> <tr> <th colspan="2">PRICE</th> </tr> </thead> <tbody> <tr> <td>1-24</td> <td>\$56.01</td> </tr> <tr> <td>25-49</td> <td>\$53.21</td> </tr> <tr> <td>50-99</td> <td>\$50.41</td> </tr> <tr> <td>100+</td> <td>\$48.17</td> </tr> </tbody> </table> <p>4.1/9.5 Mini DIN Female to N Male VSWR 1.25:1 to 6 GHz Model No: PE91219</p>	PRICE		1-24	\$56.01	25-49	\$53.21	50-99	\$50.41	100+	\$48.17	 <table border="1"> <thead> <tr> <th colspan="2">PRICE</th> </tr> </thead> <tbody> <tr> <td>1-24</td> <td>\$70.42</td> </tr> <tr> <td>25-49</td> <td>\$66.90</td> </tr> <tr> <td>50-99</td> <td>\$63.38</td> </tr> <tr> <td>100+</td> <td>\$60.56</td> </tr> </tbody> </table> <p>4.1/9.5 Mini DIN Female to N Male VSWR 1.3:1 to 6 GHz Model No: PE91256</p>	PRICE		1-24	\$70.42	25-49	\$66.90	50-99	\$63.38	100+	\$60.56
PRICE																																																							
1-24	\$61.62																																																						
25-49	\$58.54																																																						
50-99	\$55.46																																																						
100+	\$52.99																																																						
PRICE																																																							
1-24	\$64.01																																																						
25-49	\$60.81																																																						
50-99	\$57.61																																																						
100+	\$55.05																																																						
PRICE																																																							
1-24	\$57.46																																																						
25-49	\$54.59																																																						
50-99	\$51.71																																																						
100+	\$49.42																																																						
PRICE																																																							
1-24	\$56.01																																																						
25-49	\$53.21																																																						
50-99	\$50.41																																																						
100+	\$48.17																																																						
PRICE																																																							
1-24	\$70.42																																																						
25-49	\$66.90																																																						
50-99	\$63.38																																																						
100+	\$60.56																																																						
2	 <table border="1"> <thead> <tr> <th colspan="2">PRICE</th> </tr> </thead> <tbody> <tr> <td>1-24</td> <td>\$59.07</td> </tr> <tr> <td>25-49</td> <td>\$56.12</td> </tr> <tr> <td>50-99</td> <td>\$53.16</td> </tr> <tr> <td>100+</td> <td>\$50.80</td> </tr> </tbody> </table> <p>Low PIM 4.1/9.5 Mini DIN Female to N Male VSWR 1.25:1 to 6 GHz Model No: PE91094</p>	PRICE		1-24	\$59.07	25-49	\$56.12	50-99	\$53.16	100+	\$50.80	 <table border="1"> <thead> <tr> <th colspan="2">PRICE</th> </tr> </thead> <tbody> <tr> <td>1-24</td> <td>\$56.01</td> </tr> <tr> <td>25-49</td> <td>\$53.21</td> </tr> <tr> <td>50-99</td> <td>\$50.41</td> </tr> <tr> <td>100+</td> <td>\$48.17</td> </tr> </tbody> </table> <p>4.1/9.5 Mini DIN Female to N Female VSWR 1.25:1 to 6 GHz Model No: PE91218</p>	PRICE		1-24	\$56.01	25-49	\$53.21	50-99	\$50.41	100+	\$48.17	 <table border="1"> <thead> <tr> <th colspan="2">PRICE</th> </tr> </thead> <tbody> <tr> <td>1-24</td> <td>\$61.61</td> </tr> <tr> <td>25-49</td> <td>\$58.53</td> </tr> <tr> <td>50-99</td> <td>\$55.45</td> </tr> <tr> <td>100+</td> <td>\$52.98</td> </tr> </tbody> </table> <p>4.1/9.5 Mini DIN Female to N Female VSWR 1.3:1 to 6 GHz Model No: PE91255</p>	PRICE		1-24	\$61.61	25-49	\$58.53	50-99	\$55.45	100+	\$52.98	 <table border="1"> <thead> <tr> <th colspan="2">PRICE</th> </tr> </thead> <tbody> <tr> <td>1-24</td> <td>\$59.07</td> </tr> <tr> <td>25-49</td> <td>\$56.12</td> </tr> <tr> <td>50-99</td> <td>\$53.16</td> </tr> <tr> <td>100+</td> <td>\$50.80</td> </tr> </tbody> </table> <p>Low PIM 4.1/9.5 Mini DIN Female to N Female VSWR 1.25:1 to 6 GHz Model No: PE91095</p>	PRICE		1-24	\$59.07	25-49	\$56.12	50-99	\$53.16	100+	\$50.80	 <table border="1"> <thead> <tr> <th colspan="2">PRICE</th> </tr> </thead> <tbody> <tr> <td>1-24</td> <td>\$69.56</td> </tr> <tr> <td>25-49</td> <td>\$66.08</td> </tr> <tr> <td>50-99</td> <td>\$62.60</td> </tr> <tr> <td>100+</td> <td>\$59.82</td> </tr> </tbody> </table> <p>4.1/9.5 Mini DIN Female to N Female Bulkhead VSWR 1.25:1 to 6 GHz Model No: PE91220</p>	PRICE		1-24	\$69.56	25-49	\$66.08	50-99	\$62.60	100+	\$59.82
PRICE																																																							
1-24	\$59.07																																																						
25-49	\$56.12																																																						
50-99	\$53.16																																																						
100+	\$50.80																																																						
PRICE																																																							
1-24	\$56.01																																																						
25-49	\$53.21																																																						
50-99	\$50.41																																																						
100+	\$48.17																																																						
PRICE																																																							
1-24	\$61.61																																																						
25-49	\$58.53																																																						
50-99	\$55.45																																																						
100+	\$52.98																																																						
PRICE																																																							
1-24	\$59.07																																																						
25-49	\$56.12																																																						
50-99	\$53.16																																																						
100+	\$50.80																																																						
PRICE																																																							
1-24	\$69.56																																																						
25-49	\$66.08																																																						
50-99	\$62.60																																																						
100+	\$59.82																																																						
3	 <table border="1"> <thead> <tr> <th colspan="2">PRICE</th> </tr> </thead> <tbody> <tr> <td>1-24</td> <td>\$79.49</td> </tr> <tr> <td>25-49</td> <td>\$75.52</td> </tr> <tr> <td>50-99</td> <td>\$71.54</td> </tr> <tr> <td>100+</td> <td>\$68.36</td> </tr> </tbody> </table> <p>4.1/9.5 Mini DIN Female to N Female Bulkhead VSWR 1.3:1 to 6 GHz Model No: PE91257</p>	PRICE		1-24	\$79.49	25-49	\$75.52	50-99	\$71.54	100+	\$68.36	<p>4.3 <i>Non Constant In-Series</i></p> <p>→</p>		 <table border="1"> <thead> <tr> <th colspan="2">PRICE</th> </tr> </thead> <tbody> <tr> <td>1-24</td> <td>\$35.12</td> </tr> <tr> <td>25-49</td> <td>\$33.36</td> </tr> <tr> <td>50-99</td> <td>\$31.61</td> </tr> <tr> <td>100+</td> <td>\$30.20</td> </tr> </tbody> </table> <p>Low PIM NEW 4.3-10 Male to 4.3-10 Male VSWR 1.25:1 to 6 GHz Model No: PE91466</p>	PRICE		1-24	\$35.12	25-49	\$33.36	50-99	\$31.61	100+	\$30.20	 <table border="1"> <thead> <tr> <th colspan="2">PRICE</th> </tr> </thead> <tbody> <tr> <td>1-24</td> <td>\$80.00</td> </tr> <tr> <td>25-49</td> <td>\$76.00</td> </tr> <tr> <td>50-99</td> <td>\$72.00</td> </tr> <tr> <td>100+</td> <td>\$68.80</td> </tr> </tbody> </table> <p>Low PIM NEW 4.3-10 Male to 4.3-10 Male VSWR 1.08:1 to 6 GHz Model No: PE91385</p>	PRICE		1-24	\$80.00	25-49	\$76.00	50-99	\$72.00	100+	\$68.80	 <table border="1"> <thead> <tr> <th colspan="2">PRICE</th> </tr> </thead> <tbody> <tr> <td>1-24</td> <td>\$39.69</td> </tr> <tr> <td>25-49</td> <td>\$37.71</td> </tr> <tr> <td>50-99</td> <td>\$35.72</td> </tr> <tr> <td>100+</td> <td>\$34.13</td> </tr> </tbody> </table> <p>Low PIM NEW 4.3-10 Male to 4.3-10 Female VSWR 1.25:1 to 6 GHz Model No: PE91465</p>	PRICE		1-24	\$39.69	25-49	\$37.71	50-99	\$35.72	100+	\$34.13									
PRICE																																																							
1-24	\$79.49																																																						
25-49	\$75.52																																																						
50-99	\$71.54																																																						
100+	\$68.36																																																						
PRICE																																																							
1-24	\$35.12																																																						
25-49	\$33.36																																																						
50-99	\$31.61																																																						
100+	\$30.20																																																						
PRICE																																																							
1-24	\$80.00																																																						
25-49	\$76.00																																																						
50-99	\$72.00																																																						
100+	\$68.80																																																						
PRICE																																																							
1-24	\$39.69																																																						
25-49	\$37.71																																																						
50-99	\$35.72																																																						
100+	\$34.13																																																						
4	 <table border="1"> <thead> <tr> <th colspan="2">PRICE</th> </tr> </thead> <tbody> <tr> <td>1-24</td> <td>\$80.00</td> </tr> <tr> <td>25-49</td> <td>\$76.00</td> </tr> <tr> <td>50-99</td> <td>\$72.00</td> </tr> <tr> <td>100+</td> <td>\$68.80</td> </tr> </tbody> </table> <p>Low PIM NEW 4.3-10 Male to 4.3-10 Female Right Angle VSWR 1.2:1 to 3 GHz Model No: PE91467</p>	PRICE		1-24	\$80.00	25-49	\$76.00	50-99	\$72.00	100+	\$68.80	 <table border="1"> <thead> <tr> <th colspan="2">PRICE</th> </tr> </thead> <tbody> <tr> <td>1-24</td> <td>\$81.02</td> </tr> <tr> <td>25-49</td> <td>\$77.78</td> </tr> <tr> <td>50-99</td> <td>\$75.35</td> </tr> <tr> <td>100+</td> <td>\$73.73</td> </tr> </tbody> </table> <p>Low PIM 4.3-10 Male to 4.3-10 Female VSWR 1.08:1 to 6 GHz Model No: PE91387</p>	PRICE		1-24	\$81.02	25-49	\$77.78	50-99	\$75.35	100+	\$73.73	 <table border="1"> <thead> <tr> <th colspan="2">PRICE</th> </tr> </thead> <tbody> <tr> <td>1-24</td> <td>\$39.69</td> </tr> <tr> <td>25-49</td> <td>\$37.71</td> </tr> <tr> <td>50-99</td> <td>\$35.72</td> </tr> <tr> <td>100+</td> <td>\$34.13</td> </tr> </tbody> </table> <p>Low PIM NEW 4.3-10 Female to 4.3-10 Female VSWR 1.25:1 to 6 GHz Model No: PE91464</p>	PRICE		1-24	\$39.69	25-49	\$37.71	50-99	\$35.72	100+	\$34.13	 <table border="1"> <thead> <tr> <th colspan="2">PRICE</th> </tr> </thead> <tbody> <tr> <td>1-24</td> <td>\$82.65</td> </tr> <tr> <td>25-49</td> <td>\$78.52</td> </tr> <tr> <td>50-99</td> <td>\$74.39</td> </tr> <tr> <td>100+</td> <td>\$71.08</td> </tr> </tbody> </table> <p>Low PIM NEW 4.3-10 Female to 4.3-10 Female VSWR 1.08:1 to 6 GHz Model No: PE91386</p>	PRICE		1-24	\$82.65	25-49	\$78.52	50-99	\$74.39	100+	\$71.08	<p>4.3 <i>Non Constant Between Series</i></p> <p>→</p>										
PRICE																																																							
1-24	\$80.00																																																						
25-49	\$76.00																																																						
50-99	\$72.00																																																						
100+	\$68.80																																																						
PRICE																																																							
1-24	\$81.02																																																						
25-49	\$77.78																																																						
50-99	\$75.35																																																						
100+	\$73.73																																																						
PRICE																																																							
1-24	\$39.69																																																						
25-49	\$37.71																																																						
50-99	\$35.72																																																						
100+	\$34.13																																																						
PRICE																																																							
1-24	\$82.65																																																						
25-49	\$78.52																																																						
50-99	\$74.39																																																						
100+	\$71.08																																																						
5	 <table border="1"> <thead> <tr> <th colspan="2">PRICE</th> </tr> </thead> <tbody> <tr> <td>1-24</td> <td>\$35.12</td> </tr> <tr> <td>25-49</td> <td>\$33.36</td> </tr> <tr> <td>50-99</td> <td>\$31.61</td> </tr> <tr> <td>100+</td> <td>\$30.20</td> </tr> </tbody> </table> <p>Low PIM NEW 4.3-10 Male to N Male VSWR 1.25:1 to 6 GHz Model No: PE91476</p>	PRICE		1-24	\$35.12	25-49	\$33.36	50-99	\$31.61	100+	\$30.20	 <table border="1"> <thead> <tr> <th colspan="2">PRICE</th> </tr> </thead> <tbody> <tr> <td>1-24</td> <td>\$48.00</td> </tr> <tr> <td>25-49</td> <td>\$45.60</td> </tr> <tr> <td>50-99</td> <td>\$43.20</td> </tr> <tr> <td>100+</td> <td>\$41.28</td> </tr> </tbody> </table> <p>Low PIM NEW QD 4.3-10 Male to N Male VSWR 1.25:1 to 6 GHz Model No: PE91480</p>	PRICE		1-24	\$48.00	25-49	\$45.60	50-99	\$43.20	100+	\$41.28	 <table border="1"> <thead> <tr> <th colspan="2">PRICE</th> </tr> </thead> <tbody> <tr> <td>1-24</td> <td>\$35.12</td> </tr> <tr> <td>25-49</td> <td>\$33.36</td> </tr> <tr> <td>50-99</td> <td>\$31.61</td> </tr> <tr> <td>100+</td> <td>\$30.20</td> </tr> </tbody> </table> <p>Low PIM NEW 4.3-10 Male to N Female VSWR 1.25:1 to 6 GHz Model No: PE91474</p>	PRICE		1-24	\$35.12	25-49	\$33.36	50-99	\$31.61	100+	\$30.20	 <table border="1"> <thead> <tr> <th colspan="2">PRICE</th> </tr> </thead> <tbody> <tr> <td>1-24</td> <td>\$35.12</td> </tr> <tr> <td>25-49</td> <td>\$33.36</td> </tr> <tr> <td>50-99</td> <td>\$31.61</td> </tr> <tr> <td>100+</td> <td>\$30.20</td> </tr> </tbody> </table> <p>Low PIM NEW 4.3-10 Male to N Female VSWR 1.25:1 to 6 GHz Model No: PE91477</p>	PRICE		1-24	\$35.12	25-49	\$33.36	50-99	\$31.61	100+	\$30.20	 <table border="1"> <thead> <tr> <th colspan="2">PRICE</th> </tr> </thead> <tbody> <tr> <td>1-24</td> <td>\$46.20</td> </tr> <tr> <td>25-49</td> <td>\$43.89</td> </tr> <tr> <td>50-99</td> <td>\$41.58</td> </tr> <tr> <td>100+</td> <td>\$39.73</td> </tr> </tbody> </table> <p>Low PIM NEW QD 4.3-10 Male to N Female VSWR 1.25:1 to 6 GHz Model No: PE91478</p>	PRICE		1-24	\$46.20	25-49	\$43.89	50-99	\$41.58	100+	\$39.73
PRICE																																																							
1-24	\$35.12																																																						
25-49	\$33.36																																																						
50-99	\$31.61																																																						
100+	\$30.20																																																						
PRICE																																																							
1-24	\$48.00																																																						
25-49	\$45.60																																																						
50-99	\$43.20																																																						
100+	\$41.28																																																						
PRICE																																																							
1-24	\$35.12																																																						
25-49	\$33.36																																																						
50-99	\$31.61																																																						
100+	\$30.20																																																						
PRICE																																																							
1-24	\$35.12																																																						
25-49	\$33.36																																																						
50-99	\$31.61																																																						
100+	\$30.20																																																						
PRICE																																																							
1-24	\$46.20																																																						
25-49	\$43.89																																																						
50-99	\$41.58																																																						
100+	\$39.73																																																						
6	 <table border="1"> <thead> <tr> <th colspan="2">PRICE</th> </tr> </thead> <tbody> <tr> <td>1-24</td> <td>\$56.45</td> </tr> <tr> <td>25-49</td> <td>\$53.63</td> </tr> <tr> <td>50-99</td> <td>\$50.81</td> </tr> <tr> <td>100+</td> <td>\$48.55</td> </tr> </tbody> </table> <p>Low PIM NEW 4.3-10 Male to N Female Right Angle VSWR 1.25:1 to 6 GHz Model No: PE91483</p>	PRICE		1-24	\$56.45	25-49	\$53.63	50-99	\$50.81	100+	\$48.55	 <table border="1"> <thead> <tr> <th colspan="2">PRICE</th> </tr> </thead> <tbody> <tr> <td>1-24</td> <td>\$84.23</td> </tr> <tr> <td>25-49</td> <td>\$80.02</td> </tr> <tr> <td>50-99</td> <td>\$75.81</td> </tr> <tr> <td>100+</td> <td>\$72.44</td> </tr> </tbody> </table> <p>Low PIM NEW 4.3-10 Male to N Female VSWR 1.08:1 to 6 GHz Model No: PE91389</p>	PRICE		1-24	\$84.23	25-49	\$80.02	50-99	\$75.81	100+	\$72.44	 <table border="1"> <thead> <tr> <th colspan="2">PRICE</th> </tr> </thead> <tbody> <tr> <td>1-24</td> <td>\$34.63</td> </tr> <tr> <td>25-49</td> <td>\$32.90</td> </tr> <tr> <td>50-99</td> <td>\$31.17</td> </tr> <tr> <td>100+</td> <td>\$29.78</td> </tr> </tbody> </table> <p>Low PIM NEW 4.3-10 Male to SMA Female VSWR 1.15:1 to 6 GHz Model No: PE91484</p>	PRICE		1-24	\$34.63	25-49	\$32.90	50-99	\$31.17	100+	\$29.78	 <table border="1"> <thead> <tr> <th colspan="2">PRICE</th> </tr> </thead> <tbody> <tr> <td>1-24</td> <td>\$41.28</td> </tr> <tr> <td>25-49</td> <td>\$39.22</td> </tr> <tr> <td>50-99</td> <td>\$37.15</td> </tr> <tr> <td>100+</td> <td>\$35.50</td> </tr> </tbody> </table> <p>Low PIM NEW 4.3-10 Female to N Male VSWR 1.25:1 to 6 GHz Model No: PE91479</p>	PRICE		1-24	\$41.28	25-49	\$39.22	50-99	\$37.15	100+	\$35.50	 <table border="1"> <thead> <tr> <th colspan="2">PRICE</th> </tr> </thead> <tbody> <tr> <td>1-24</td> <td>\$38.93</td> </tr> <tr> <td>25-49</td> <td>\$36.98</td> </tr> <tr> <td>50-99</td> <td>\$35.04</td> </tr> <tr> <td>100+</td> <td>\$33.48</td> </tr> </tbody> </table> <p>Low PIM NEW QD 4.3-10 Female to N Male VSWR 1.25:1 to 6 GHz Model No: PE91481</p>	PRICE		1-24	\$38.93	25-49	\$36.98	50-99	\$35.04	100+	\$33.48
PRICE																																																							
1-24	\$56.45																																																						
25-49	\$53.63																																																						
50-99	\$50.81																																																						
100+	\$48.55																																																						
PRICE																																																							
1-24	\$84.23																																																						
25-49	\$80.02																																																						
50-99	\$75.81																																																						
100+	\$72.44																																																						
PRICE																																																							
1-24	\$34.63																																																						
25-49	\$32.90																																																						
50-99	\$31.17																																																						
100+	\$29.78																																																						
PRICE																																																							
1-24	\$41.28																																																						
25-49	\$39.22																																																						
50-99	\$37.15																																																						
100+	\$35.50																																																						
PRICE																																																							
1-24	\$38.93																																																						
25-49	\$36.98																																																						
50-99	\$35.04																																																						
100+	\$33.48																																																						
7	 <table border="1"> <thead> <tr> <th colspan="2">PRICE</th> </tr> </thead> <tbody> <tr> <td>1-24</td> <td>\$35.88</td> </tr> <tr> <td>25-49</td> <td>\$34.09</td> </tr> <tr> <td>50-99</td> <td>\$32.29</td> </tr> <tr> <td>100+</td> <td>\$30.86</td> </tr> </tbody> </table> <p>Low PIM NEW 4.3-10 Female to N Female VSWR 1.25:1 to 6 GHz Model No: PE91475</p>	PRICE		1-24	\$35.88	25-49	\$34.09	50-99	\$32.29	100+	\$30.86	 <table border="1"> <thead> <tr> <th colspan="2">PRICE</th> </tr> </thead> <tbody> <tr> <td>1-24</td> <td>\$38.72</td> </tr> <tr> <td>25-49</td> <td>\$36.78</td> </tr> <tr> <td>50-99</td> <td>\$34.85</td> </tr> <tr> <td>100+</td> <td>\$33.30</td> </tr> </tbody> </table> <p>Low PIM NEW QD 4.3-10 Female to N Female VSWR 1.25:1 to 6 GHz Model No: PE91482</p>	PRICE		1-24	\$38.72	25-49	\$36.78	50-99	\$34.85	100+	\$33.30	<p>7/16 DIN <i>In-Series</i></p> <p>→</p>		 <table border="1"> <thead> <tr> <th colspan="2">PRICE</th> </tr> </thead> <tbody> <tr> <td>1-24</td> <td>\$85.18</td> </tr> <tr> <td>25-49</td> <td>\$80.92</td> </tr> <tr> <td>50-99</td> <td>\$76.66</td> </tr> <tr> <td>100+</td> <td>\$73.25</td> </tr> </tbody> </table> <p>7/16 DIN Male to 7/16 DIN Male VSWR 1.15:1 to 6 GHz Model No: PE91190</p>	PRICE		1-24	\$85.18	25-49	\$80.92	50-99	\$76.66	100+	\$73.25	 <table border="1"> <thead> <tr> <th colspan="2">PRICE</th> </tr> </thead> <tbody> <tr> <td>1-24</td> <td>\$88.90</td> </tr> <tr> <td>25-49</td> <td>\$84.46</td> </tr> <tr> <td>50-99</td> <td>\$80.01</td> </tr> <tr> <td>100+</td> <td>\$76.45</td> </tr> </tbody> </table> <p>7/16 DIN Male to 7/16 DIN Male VSWR 1.25:1 to 6 GHz Model No: PE91227</p>	PRICE		1-24	\$88.90	25-49	\$84.46	50-99	\$80.01	100+	\$76.45									
PRICE																																																							
1-24	\$35.88																																																						
25-49	\$34.09																																																						
50-99	\$32.29																																																						
100+	\$30.86																																																						
PRICE																																																							
1-24	\$38.72																																																						
25-49	\$36.78																																																						
50-99	\$34.85																																																						
100+	\$33.30																																																						
PRICE																																																							
1-24	\$85.18																																																						
25-49	\$80.92																																																						
50-99	\$76.66																																																						
100+	\$73.25																																																						
PRICE																																																							
1-24	\$88.90																																																						
25-49	\$84.46																																																						
50-99	\$80.01																																																						
100+	\$76.45																																																						

ADAPTERS

See Adapter Locator on Pages 8-13

See Page 369 for Mounting Holes

	A	B	C	D	E																																													
1	 <table border="1"> <thead> <tr><th>PRICE</th></tr> </thead> <tbody> <tr><td>1-9</td><td>\$114.26</td></tr> <tr><td>10-24</td><td>\$108.55</td></tr> <tr><td>25-49</td><td>\$102.83</td></tr> <tr><td>50+</td><td>\$98.26</td></tr> </tbody> </table> <p>Low PIM</p> <p>7/16 DIN Male to 7/16 DIN Male</p> <p>Max. Freq. 8 GHz</p> <p>Model No: PE91039</p>	PRICE	1-9	\$114.26	10-24	\$108.55	25-49	\$102.83	50+	\$98.26	 <table border="1"> <thead> <tr><th>PRICE</th></tr> </thead> <tbody> <tr><td>1-24</td><td>\$65.52</td></tr> <tr><td>25-49</td><td>\$62.24</td></tr> <tr><td>50-99</td><td>\$58.97</td></tr> <tr><td>100+</td><td>\$56.35</td></tr> </tbody> </table> <p>7/16 DIN Male to 7/16 DIN Female</p> <p>VSWR 1.15:1 to 6 GHz</p> <p>Model No: PE91191</p>	PRICE	1-24	\$65.52	25-49	\$62.24	50-99	\$58.97	100+	\$56.35	 <table border="1"> <thead> <tr><th>PRICE</th></tr> </thead> <tbody> <tr><td>1-24</td><td>\$67.57</td></tr> <tr><td>25-49</td><td>\$64.19</td></tr> <tr><td>50-99</td><td>\$60.81</td></tr> <tr><td>100+</td><td>\$58.11</td></tr> </tbody> </table> <p>7/16 DIN Male to 7/16 DIN Female</p> <p>VSWR 1.25:1 to 6 GHz</p> <p>Model No: PE91228</p>	PRICE	1-24	\$67.57	25-49	\$64.19	50-99	\$60.81	100+	\$58.11	 <table border="1"> <thead> <tr><th>PRICE</th></tr> </thead> <tbody> <tr><td>1-9</td><td>\$128.97</td></tr> <tr><td>10-24</td><td>\$122.52</td></tr> <tr><td>25-49</td><td>\$116.07</td></tr> <tr><td>50+</td><td>\$110.91</td></tr> </tbody> </table> <p>7/16 DIN Male to 7/16 DIN Female</p> <p>VSWR 1.35:1 to 7.5 GHz</p> <p>Model No: PE91027</p>	PRICE	1-9	\$128.97	10-24	\$122.52	25-49	\$116.07	50+	\$110.91	 <table border="1"> <thead> <tr><th>PRICE</th></tr> </thead> <tbody> <tr><td>1-9</td><td>\$108.84</td></tr> <tr><td>10-24</td><td>\$103.40</td></tr> <tr><td>25-49</td><td>\$97.96</td></tr> <tr><td>50+</td><td>\$93.60</td></tr> </tbody> </table> <p>Low PIM</p> <p>7/16 DIN Male to 7/16 DIN Female</p> <p>Max. Freq. 8 GHz</p> <p>Model No: PE91028</p>	PRICE	1-9	\$108.84	10-24	\$103.40	25-49	\$97.96	50+	\$93.60
	PRICE																																																	
1-9	\$114.26																																																	
10-24	\$108.55																																																	
25-49	\$102.83																																																	
50+	\$98.26																																																	
PRICE																																																		
1-24	\$65.52																																																	
25-49	\$62.24																																																	
50-99	\$58.97																																																	
100+	\$56.35																																																	
PRICE																																																		
1-24	\$67.57																																																	
25-49	\$64.19																																																	
50-99	\$60.81																																																	
100+	\$58.11																																																	
PRICE																																																		
1-9	\$128.97																																																	
10-24	\$122.52																																																	
25-49	\$116.07																																																	
50+	\$110.91																																																	
PRICE																																																		
1-9	\$108.84																																																	
10-24	\$103.40																																																	
25-49	\$97.96																																																	
50+	\$93.60																																																	
2	 <table border="1"> <thead> <tr><th>PRICE</th></tr> </thead> <tbody> <tr><td>1-24</td><td>\$78.60</td></tr> <tr><td>25-49</td><td>\$74.67</td></tr> <tr><td>50-99</td><td>\$70.74</td></tr> <tr><td>100+</td><td>\$67.60</td></tr> </tbody> </table> <p>7/16 DIN Male to 7/16 DIN Female Right Angle</p> <p>VSWR 1.25:1 to 6 GHz</p> <p>Model No: PE91117</p>	PRICE	1-24	\$78.60	25-49	\$74.67	50-99	\$70.74	100+	\$67.60	 <table border="1"> <thead> <tr><th>PRICE</th></tr> </thead> <tbody> <tr><td>1-9</td><td>\$260.35</td></tr> <tr><td>10-24</td><td>\$247.33</td></tr> <tr><td>25-49</td><td>\$234.32</td></tr> <tr><td>50+</td><td>\$223.90</td></tr> </tbody> </table> <p>7/16 DIN Female to 7/16 DIN Male Tee</p> <p>Model No: PE9557</p>	PRICE	1-9	\$260.35	10-24	\$247.33	25-49	\$234.32	50+	\$223.90	 <table border="1"> <thead> <tr><th>PRICE</th></tr> </thead> <tbody> <tr><td>1-24</td><td>\$72.79</td></tr> <tr><td>25-49</td><td>\$69.15</td></tr> <tr><td>50-99</td><td>\$65.51</td></tr> <tr><td>100+</td><td>\$62.60</td></tr> </tbody> </table> <p>7/16 DIN Female to 7/16 DIN Female</p> <p>VSWR 1.15:1 to 6 GHz</p> <p>Model No: PE91192</p>	PRICE	1-24	\$72.79	25-49	\$69.15	50-99	\$65.51	100+	\$62.60	 <table border="1"> <thead> <tr><th>PRICE</th></tr> </thead> <tbody> <tr><td>1-24</td><td>\$59.59</td></tr> <tr><td>25-49</td><td>\$56.61</td></tr> <tr><td>50-99</td><td>\$53.63</td></tr> <tr><td>100+</td><td>\$51.25</td></tr> </tbody> </table> <p>7/16 DIN Female to 7/16 DIN Female</p> <p>VSWR 1.25:1 to 6 GHz</p> <p>Model No: PE91229</p>	PRICE	1-24	\$59.59	25-49	\$56.61	50-99	\$53.63	100+	\$51.25	 <table border="1"> <thead> <tr><th>PRICE</th></tr> </thead> <tbody> <tr><td>1-9</td><td>\$108.84</td></tr> <tr><td>10-24</td><td>\$103.40</td></tr> <tr><td>25-49</td><td>\$97.96</td></tr> <tr><td>50+</td><td>\$93.60</td></tr> </tbody> </table> <p>Low PIM</p> <p>7/16 DIN Female to 7/16 DIN Female</p> <p>Max. Freq. 8 GHz</p> <p>Model No: PE91029</p>	PRICE	1-9	\$108.84	10-24	\$103.40	25-49	\$97.96	50+	\$93.60
	PRICE																																																	
1-24	\$78.60																																																	
25-49	\$74.67																																																	
50-99	\$70.74																																																	
100+	\$67.60																																																	
PRICE																																																		
1-9	\$260.35																																																	
10-24	\$247.33																																																	
25-49	\$234.32																																																	
50+	\$223.90																																																	
PRICE																																																		
1-24	\$72.79																																																	
25-49	\$69.15																																																	
50-99	\$65.51																																																	
100+	\$62.60																																																	
PRICE																																																		
1-24	\$59.59																																																	
25-49	\$56.61																																																	
50-99	\$53.63																																																	
100+	\$51.25																																																	
PRICE																																																		
1-9	\$108.84																																																	
10-24	\$103.40																																																	
25-49	\$97.96																																																	
50+	\$93.60																																																	
3	 <table border="1"> <thead> <tr><th>PRICE</th></tr> </thead> <tbody> <tr><td>1-9</td><td>\$121.40</td></tr> <tr><td>10-24</td><td>\$115.33</td></tr> <tr><td>25-49</td><td>\$109.26</td></tr> <tr><td>50+</td><td>\$104.40</td></tr> </tbody> </table> <p>7/16 DIN Female to 7/16 DIN Female</p> <p>Model No: PE9409</p>	PRICE	1-9	\$121.40	10-24	\$115.33	25-49	\$109.26	50+	\$104.40	 <table border="1"> <thead> <tr><th>PRICE</th></tr> </thead> <tbody> <tr><td>1-9</td><td>\$272.54</td></tr> <tr><td>10-24</td><td>\$258.91</td></tr> <tr><td>25-49</td><td>\$245.29</td></tr> <tr><td>50+</td><td>\$234.38</td></tr> </tbody> </table> <p>7/16 DIN Female to 7/16 DIN Female Tee</p> <p>Model No: PE9556</p>	PRICE	1-9	\$272.54	10-24	\$258.91	25-49	\$245.29	50+	\$234.38	 <table border="1"> <thead> <tr><th>PRICE</th></tr> </thead> <tbody> <tr><td>1-9</td><td>\$142.97</td></tr> <tr><td>10-24</td><td>\$135.82</td></tr> <tr><td>25-49</td><td>\$128.67</td></tr> <tr><td>50+</td><td>\$122.95</td></tr> </tbody> </table> <p>Low PIM</p> <p>7/16 DIN Female to 7/16 DIN Female Bulkhead</p> <p>Max. Freq. 8 GHz</p> <p>Model No: PE91038</p>	PRICE	1-9	\$142.97	10-24	\$135.82	25-49	\$128.67	50+	\$122.95	 <table border="1"> <thead> <tr><th>PRICE</th></tr> </thead> <tbody> <tr><td>1-9</td><td>\$269.67</td></tr> <tr><td>10-24</td><td>\$256.19</td></tr> <tr><td>25-49</td><td>\$242.70</td></tr> <tr><td>50+</td><td>\$231.92</td></tr> </tbody> </table> <p>7/16 DIN Female to 7/16 DIN Female Bulkhead</p> <p>Model No: PE9414</p>	PRICE	1-9	\$269.67	10-24	\$256.19	25-49	\$242.70	50+	\$231.92	 <table border="1"> <thead> <tr><th>PRICE</th></tr> </thead> <tbody> <tr><td>1-24</td><td>\$100.74</td></tr> <tr><td>25-49</td><td>\$95.70</td></tr> <tr><td>50-99</td><td>\$90.67</td></tr> <tr><td>100+</td><td>\$86.64</td></tr> </tbody> </table> <p>7/16 DIN Female to 7/16 DIN Female Bulkhead</p> <p>VSWR 1.25:1 to 6 GHz</p> <p>Model No: PE91193</p>	PRICE	1-24	\$100.74	25-49	\$95.70	50-99	\$90.67	100+	\$86.64
	PRICE																																																	
1-9	\$121.40																																																	
10-24	\$115.33																																																	
25-49	\$109.26																																																	
50+	\$104.40																																																	
PRICE																																																		
1-9	\$272.54																																																	
10-24	\$258.91																																																	
25-49	\$245.29																																																	
50+	\$234.38																																																	
PRICE																																																		
1-9	\$142.97																																																	
10-24	\$135.82																																																	
25-49	\$128.67																																																	
50+	\$122.95																																																	
PRICE																																																		
1-9	\$269.67																																																	
10-24	\$256.19																																																	
25-49	\$242.70																																																	
50+	\$231.92																																																	
PRICE																																																		
1-24	\$100.74																																																	
25-49	\$95.70																																																	
50-99	\$90.67																																																	
100+	\$86.64																																																	
4	 <table border="1"> <thead> <tr><th>PRICE</th></tr> </thead> <tbody> <tr><td>1-24</td><td>\$93.13</td></tr> <tr><td>25-49</td><td>\$88.47</td></tr> <tr><td>50-99</td><td>\$83.82</td></tr> <tr><td>100+</td><td>\$80.09</td></tr> </tbody> </table> <p>7/16 DIN Female to 7/16 DIN Female Bulkhead</p> <p>VSWR 1.25:1 to 6 GHz</p> <p>Model No: PE91230</p>	PRICE	1-24	\$93.13	25-49	\$88.47	50-99	\$83.82	100+	\$80.09	<p>7/16 DIN Between Series</p> <p>→</p>		 <table border="1"> <thead> <tr><th>PRICE</th></tr> </thead> <tbody> <tr><td>1-24</td><td>\$68.08</td></tr> <tr><td>25-49</td><td>\$64.68</td></tr> <tr><td>50-99</td><td>\$61.27</td></tr> <tr><td>100+</td><td>\$58.55</td></tr> </tbody> </table> <p>7/16 DIN Male to 4.1/9.5 Mini DIN Male</p> <p>VSWR 1.25:1 to 6 GHz</p> <p>Model No: PE91206</p>	PRICE	1-24	\$68.08	25-49	\$64.68	50-99	\$61.27	100+	\$58.55	 <table border="1"> <thead> <tr><th>PRICE</th></tr> </thead> <tbody> <tr><td>1-24</td><td>\$38.62</td></tr> <tr><td>25-49</td><td>\$36.69</td></tr> <tr><td>50-99</td><td>\$34.76</td></tr> <tr><td>100+</td><td>\$33.21</td></tr> </tbody> </table> <p>7/16 DIN Male to 4.1/9.5 Mini DIN Male</p> <p>VSWR 1.3:1 to 6 GHz</p> <p>Model No: PE91243</p>	PRICE	1-24	\$38.62	25-49	\$36.69	50-99	\$34.76	100+	\$33.21	 <table border="1"> <thead> <tr><th>PRICE</th></tr> </thead> <tbody> <tr><td>1-24</td><td>\$77.31</td></tr> <tr><td>25-49</td><td>\$73.44</td></tr> <tr><td>50-99</td><td>\$69.58</td></tr> <tr><td>100+</td><td>\$66.49</td></tr> </tbody> </table> <p>Low PIM</p> <p>7/16 DIN Male to 4.1/9.5 Mini DIN Male</p> <p>VSWR 1.25:1 to 6 GHz</p> <p>Model No: PE91088</p>	PRICE	1-24	\$77.31	25-49	\$73.44	50-99	\$69.58	100+	\$66.49								
	PRICE																																																	
1-24	\$93.13																																																	
25-49	\$88.47																																																	
50-99	\$83.82																																																	
100+	\$80.09																																																	
PRICE																																																		
1-24	\$68.08																																																	
25-49	\$64.68																																																	
50-99	\$61.27																																																	
100+	\$58.55																																																	
PRICE																																																		
1-24	\$38.62																																																	
25-49	\$36.69																																																	
50-99	\$34.76																																																	
100+	\$33.21																																																	
PRICE																																																		
1-24	\$77.31																																																	
25-49	\$73.44																																																	
50-99	\$69.58																																																	
100+	\$66.49																																																	
5	 <table border="1"> <thead> <tr><th>PRICE</th></tr> </thead> <tbody> <tr><td>1-24</td><td>\$59.56</td></tr> <tr><td>25-49</td><td>\$56.58</td></tr> <tr><td>50-99</td><td>\$53.60</td></tr> <tr><td>100+</td><td>\$51.22</td></tr> </tbody> </table> <p>7/16 DIN Male to 4.1/9.5 Mini DIN Female</p> <p>VSWR 1.25:1 to 6 GHz</p> <p>Model No: PE91207</p>	PRICE	1-24	\$59.56	25-49	\$56.58	50-99	\$53.60	100+	\$51.22	 <table border="1"> <thead> <tr><th>PRICE</th></tr> </thead> <tbody> <tr><td>1-24</td><td>\$35.80</td></tr> <tr><td>25-49</td><td>\$34.01</td></tr> <tr><td>50-99</td><td>\$32.22</td></tr> <tr><td>100+</td><td>\$30.79</td></tr> </tbody> </table> <p>7/16 DIN Male to 4.1/9.5 Mini DIN Female</p> <p>VSWR 1.25:1 to 6 GHz</p> <p>Model No: PE91244</p>	PRICE	1-24	\$35.80	25-49	\$34.01	50-99	\$32.22	100+	\$30.79	 <table border="1"> <thead> <tr><th>PRICE</th></tr> </thead> <tbody> <tr><td>1-24</td><td>\$83.50</td></tr> <tr><td>25-49</td><td>\$79.33</td></tr> <tr><td>50-99</td><td>\$75.15</td></tr> <tr><td>100+</td><td>\$71.81</td></tr> </tbody> </table> <p>Low PIM</p> <p>7/16 DIN Male to 4.1/9.5 Mini DIN Female</p> <p>VSWR 1.25:1 to 6 GHz</p> <p>Model No: PE91089</p>	PRICE	1-24	\$83.50	25-49	\$79.33	50-99	\$75.15	100+	\$71.81	 <table border="1"> <thead> <tr><th>PRICE</th></tr> </thead> <tbody> <tr><td>1-24</td><td>\$36.65</td></tr> <tr><td>25-49</td><td>\$34.82</td></tr> <tr><td>50-99</td><td>\$32.99</td></tr> <tr><td>100+</td><td>\$31.52</td></tr> </tbody> </table> <p>Low PIM NEW</p> <p>7/16 DIN Male to 4.3-10 Male</p> <p>VSWR 1.25:1 to 6 GHz</p> <p>Model No: PE91468</p>	PRICE	1-24	\$36.65	25-49	\$34.82	50-99	\$32.99	100+	\$31.52	 <table border="1"> <thead> <tr><th>PRICE</th></tr> </thead> <tbody> <tr><td>1-24</td><td>\$39.69</td></tr> <tr><td>25-49</td><td>\$37.71</td></tr> <tr><td>50-99</td><td>\$35.72</td></tr> <tr><td>100+</td><td>\$34.13</td></tr> </tbody> </table> <p>Low PIM NEW</p> <p>7/16 DIN Male to 4.3-10 Female</p> <p>VSWR 1.25:1 to 6 GHz</p> <p>Model No: PE91469</p>	PRICE	1-24	\$39.69	25-49	\$37.71	50-99	\$35.72	100+	\$34.13
	PRICE																																																	
1-24	\$59.56																																																	
25-49	\$56.58																																																	
50-99	\$53.60																																																	
100+	\$51.22																																																	
PRICE																																																		
1-24	\$35.80																																																	
25-49	\$34.01																																																	
50-99	\$32.22																																																	
100+	\$30.79																																																	
PRICE																																																		
1-24	\$83.50																																																	
25-49	\$79.33																																																	
50-99	\$75.15																																																	
100+	\$71.81																																																	
PRICE																																																		
1-24	\$36.65																																																	
25-49	\$34.82																																																	
50-99	\$32.99																																																	
100+	\$31.52																																																	
PRICE																																																		
1-24	\$39.69																																																	
25-49	\$37.71																																																	
50-99	\$35.72																																																	
100+	\$34.13																																																	
6	 <table border="1"> <thead> <tr><th>PRICE</th></tr> </thead> <tbody> <tr><td>1-24</td><td>\$69.15</td></tr> <tr><td>25-49</td><td>\$65.69</td></tr> <tr><td>50-99</td><td>\$62.24</td></tr> <tr><td>100+</td><td>\$59.47</td></tr> </tbody> </table> <p>Low PIM NEW</p> <p>7/16 DIN Male to 4.3-10 Female</p> <p>VSWR 1.08:1 to 6 GHz</p> <p>Model No: PE91390</p>	PRICE	1-24	\$69.15	25-49	\$65.69	50-99	\$62.24	100+	\$59.47	 <table border="1"> <thead> <tr><th>PRICE</th></tr> </thead> <tbody> <tr><td>1-9</td><td>\$160.81</td></tr> <tr><td>10-24</td><td>\$152.77</td></tr> <tr><td>25-49</td><td>\$144.73</td></tr> <tr><td>50+</td><td>\$138.30</td></tr> </tbody> </table> <p>7/16 DIN Male to HN Female</p> <p>Model No: PE9558</p>	PRICE	1-9	\$160.81	10-24	\$152.77	25-49	\$144.73	50+	\$138.30	 <table border="1"> <thead> <tr><th>PRICE</th></tr> </thead> <tbody> <tr><td>1-24</td><td>\$65.21</td></tr> <tr><td>25-49</td><td>\$61.95</td></tr> <tr><td>50-99</td><td>\$58.69</td></tr> <tr><td>100+</td><td>\$56.08</td></tr> </tbody> </table> <p>7/16 DIN Male to N Male</p> <p>VSWR 1.15:1 to 6 GHz</p> <p>Model No: PE91211</p>	PRICE	1-24	\$65.21	25-49	\$61.95	50-99	\$58.69	100+	\$56.08	 <table border="1"> <thead> <tr><th>PRICE</th></tr> </thead> <tbody> <tr><td>1-24</td><td>\$81.69</td></tr> <tr><td>25-49</td><td>\$77.61</td></tr> <tr><td>50-99</td><td>\$73.52</td></tr> <tr><td>100+</td><td>\$70.25</td></tr> </tbody> </table> <p>7/16 DIN Male to N Male</p> <p>VSWR 1.25:1 to 6 GHz</p> <p>Model No: PE91248</p>	PRICE	1-24	\$81.69	25-49	\$77.61	50-99	\$73.52	100+	\$70.25	 <table border="1"> <thead> <tr><th>PRICE</th></tr> </thead> <tbody> <tr><td>1-24</td><td>\$64.02</td></tr> <tr><td>25-49</td><td>\$60.82</td></tr> <tr><td>50-99</td><td>\$57.62</td></tr> <tr><td>100+</td><td>\$55.06</td></tr> </tbody> </table> <p>7/16 DIN Male to N Female</p> <p>VSWR 1.15:1 to 6 GHz</p> <p>Model No: PE91212</p>	PRICE	1-24	\$64.02	25-49	\$60.82	50-99	\$57.62	100+	\$55.06
	PRICE																																																	
1-24	\$69.15																																																	
25-49	\$65.69																																																	
50-99	\$62.24																																																	
100+	\$59.47																																																	
PRICE																																																		
1-9	\$160.81																																																	
10-24	\$152.77																																																	
25-49	\$144.73																																																	
50+	\$138.30																																																	
PRICE																																																		
1-24	\$65.21																																																	
25-49	\$61.95																																																	
50-99	\$58.69																																																	
100+	\$56.08																																																	
PRICE																																																		
1-24	\$81.69																																																	
25-49	\$77.61																																																	
50-99	\$73.52																																																	
100+	\$70.25																																																	
PRICE																																																		
1-24	\$64.02																																																	
25-49	\$60.82																																																	
50-99	\$57.62																																																	
100+	\$55.06																																																	
7	 <table border="1"> <thead> <tr><th>PRICE</th></tr> </thead> <tbody> <tr><td>1-24</td><td>\$47.40</td></tr> <tr><td>25-49</td><td>\$45.03</td></tr> <tr><td>50-99</td><td>\$42.66</td></tr> <tr><td>100+</td><td>\$40.76</td></tr> </tbody> </table> <p>7/16 DIN Male to N Female</p> <p>VSWR 1.25:1 to 6 GHz</p> <p>Model No: PE91249</p>	PRICE	1-24	\$47.40	25-49	\$45.03	50-99	\$42.66	100+	\$40.76	 <table border="1"> <thead> <tr><th>PRICE</th></tr> </thead> <tbody> <tr><td>1-9</td><td>\$182.18</td></tr> <tr><td>10-24</td><td>\$173.07</td></tr> <tr><td>25-49</td><td>\$163.96</td></tr> <tr><td>NEW 50+</td><td>\$156.67</td></tr> </tbody> </table> <p>7/16 DIN Male to SC Female</p> <p>VSWR 1.25:1 to 7.5 GHz</p> <p>Model No: PE91444</p>	PRICE	1-9	\$182.18	10-24	\$173.07	25-49	\$163.96	NEW 50+	\$156.67	 <table border="1"> <thead> <tr><th>PRICE</th></tr> </thead> <tbody> <tr><td>1-24</td><td>\$68.08</td></tr> <tr><td>25-49</td><td>\$64.68</td></tr> <tr><td>50-99</td><td>\$61.27</td></tr> <tr><td>100+</td><td>\$58.55</td></tr> </tbody> </table> <p>7/16 DIN Female to 4.1/9.5 Mini DIN Male</p> <p>VSWR 1.25:1 to 6 GHz</p> <p>Model No: PE91209</p>	PRICE	1-24	\$68.08	25-49	\$64.68	50-99	\$61.27	100+	\$58.55	 <table border="1"> <thead> <tr><th>PRICE</th></tr> </thead> <tbody> <tr><td>1-24</td><td>\$33.66</td></tr> <tr><td>25-49</td><td>\$31.98</td></tr> <tr><td>50-99</td><td>\$30.29</td></tr> <tr><td>100+</td><td>\$28.95</td></tr> </tbody> </table> <p>7/16 DIN Female to 4.1/9.5 Mini DIN Male</p> <p>VSWR 1.25:1 to 6 GHz</p> <p>Model No: PE91246</p>	PRICE	1-24	\$33.66	25-49	\$31.98	50-99	\$30.29	100+	\$28.95	 <table border="1"> <thead> <tr><th>PRICE</th></tr> </thead> <tbody> <tr><td>1-24</td><td>\$77.31</td></tr> <tr><td>25-49</td><td>\$73.44</td></tr> <tr><td>50-99</td><td>\$69.58</td></tr> <tr><td>100+</td><td>\$66.49</td></tr> </tbody> </table> <p>Low PIM</p> <p>7/16 DIN Female to 4.1/9.5 Mini DIN Male</p> <p>VSWR 1.25:1 to 6 GHz</p> <p>Model No: PE91090</p>	PRICE	1-24	\$77.31	25-49	\$73.44	50-99	\$69.58	100+	\$66.49
	PRICE																																																	
1-24	\$47.40																																																	
25-49	\$45.03																																																	
50-99	\$42.66																																																	
100+	\$40.76																																																	
PRICE																																																		
1-9	\$182.18																																																	
10-24	\$173.07																																																	
25-49	\$163.96																																																	
NEW 50+	\$156.67																																																	
PRICE																																																		
1-24	\$68.08																																																	
25-49	\$64.68																																																	
50-99	\$61.27																																																	
100+	\$58.55																																																	
PRICE																																																		
1-24	\$33.66																																																	
25-49	\$31.98																																																	
50-99	\$30.29																																																	
100+	\$28.95																																																	
PRICE																																																		
1-24	\$77.31																																																	
25-49	\$73.44																																																	
50-99	\$69.58																																																	
100+	\$66.49																																																	

ADAPTERS

See Adapter Locator on Pages 8-13

See Page 369 for Mounting Holes

Adapters

See Our Website For Current Pricing & Real-Time Stock Availability!

	A	B	C	D	E																																																		
1	 <table border="1"> <thead> <tr> <th colspan="2">PRICE</th> </tr> </thead> <tbody> <tr> <td>1-24</td> <td>\$61.88</td> </tr> <tr> <td>25-49</td> <td>\$58.79</td> </tr> <tr> <td>50-99</td> <td>\$55.69</td> </tr> <tr> <td>100+</td> <td>\$53.22</td> </tr> </tbody> </table> <p>7/16 DIN Female to 4.1/9.5 Mini DIN Female VSWR 1.25:1 to 6 GHz Model No: PE91208</p>	PRICE		1-24	\$61.88	25-49	\$58.79	50-99	\$55.69	100+	\$53.22	 <table border="1"> <thead> <tr> <th colspan="2">PRICE</th> </tr> </thead> <tbody> <tr> <td>1-24</td> <td>\$32.52</td> </tr> <tr> <td>25-49</td> <td>\$30.89</td> </tr> <tr> <td>50-99</td> <td>\$29.27</td> </tr> <tr> <td>100+</td> <td>\$27.97</td> </tr> </tbody> </table> <p>7/16 DIN Female to 4.1/9.5 Mini DIN Female VSWR 1.35:1 to 6 GHz Model No: PE91245</p>	PRICE		1-24	\$32.52	25-49	\$30.89	50-99	\$29.27	100+	\$27.97	 <table border="1"> <thead> <tr> <th colspan="2">PRICE</th> </tr> </thead> <tbody> <tr> <td>1-24</td> <td>\$77.31</td> </tr> <tr> <td>25-49</td> <td>\$73.44</td> </tr> <tr> <td>50-99</td> <td>\$69.58</td> </tr> <tr> <td>100+</td> <td>\$66.49</td> </tr> </tbody> </table> <p>Low PIM 7/16 DIN Female to 4.1/9.5 Mini DIN Female VSWR 1.25:1 to 6 GHz Model No: PE91091</p>	PRICE		1-24	\$77.31	25-49	\$73.44	50-99	\$69.58	100+	\$66.49	 <table border="1"> <thead> <tr> <th colspan="2">PRICE</th> </tr> </thead> <tbody> <tr> <td>1-24</td> <td>\$68.04</td> </tr> <tr> <td>25-49</td> <td>\$64.64</td> </tr> <tr> <td>50-99</td> <td>\$61.24</td> </tr> <tr> <td>100+</td> <td>\$58.51</td> </tr> </tbody> </table> <p>7/16 DIN Female to 4.1/9.5 Mini DIN Female Bulkhead VSWR 1.25:1 to 6 GHz Model No: PE91210</p>	PRICE		1-24	\$68.04	25-49	\$64.64	50-99	\$61.24	100+	\$58.51	 <table border="1"> <thead> <tr> <th colspan="2">PRICE</th> </tr> </thead> <tbody> <tr> <td>1-24</td> <td>\$34.73</td> </tr> <tr> <td>25-49</td> <td>\$32.99</td> </tr> <tr> <td>50-99</td> <td>\$31.26</td> </tr> <tr> <td>100+</td> <td>\$29.87</td> </tr> </tbody> </table> <p>7/16 DIN Female to 4.1/9.5 Mini DIN Female Bulkhead VSWR 1.3:1 to 6 GHz Model No: PE91247</p>	PRICE		1-24	\$34.73	25-49	\$32.99	50-99	\$31.26	100+	\$29.87
PRICE																																																							
1-24	\$61.88																																																						
25-49	\$58.79																																																						
50-99	\$55.69																																																						
100+	\$53.22																																																						
PRICE																																																							
1-24	\$32.52																																																						
25-49	\$30.89																																																						
50-99	\$29.27																																																						
100+	\$27.97																																																						
PRICE																																																							
1-24	\$77.31																																																						
25-49	\$73.44																																																						
50-99	\$69.58																																																						
100+	\$66.49																																																						
PRICE																																																							
1-24	\$68.04																																																						
25-49	\$64.64																																																						
50-99	\$61.24																																																						
100+	\$58.51																																																						
PRICE																																																							
1-24	\$34.73																																																						
25-49	\$32.99																																																						
50-99	\$31.26																																																						
100+	\$29.87																																																						
2	 <table border="1"> <thead> <tr> <th colspan="2">PRICE</th> </tr> </thead> <tbody> <tr> <td>1-24</td> <td>\$38.93</td> </tr> <tr> <td>25-49</td> <td>\$36.98</td> </tr> <tr> <td>50-99</td> <td>\$35.04</td> </tr> </tbody> </table> <p>Low PIM NEW 7/16 DIN Female to 4.3-10 Male VSWR 1.2:1 to 6 GHz Model No: PE91470</p>	PRICE		1-24	\$38.93	25-49	\$36.98	50-99	\$35.04	 <table border="1"> <thead> <tr> <th colspan="2">PRICE</th> </tr> </thead> <tbody> <tr> <td>1-24</td> <td>\$55.13</td> </tr> <tr> <td>25-49</td> <td>\$52.37</td> </tr> <tr> <td>50-99</td> <td>\$49.62</td> </tr> <tr> <td>100+</td> <td>\$47.41</td> </tr> </tbody> </table> <p>Low PIM NEW 7/16 DIN Female to QD 4.3-10 Male VSWR 1.2:1 to 6 GHz Model No: PE91472</p>	PRICE		1-24	\$55.13	25-49	\$52.37	50-99	\$49.62	100+	\$47.41	 <table border="1"> <thead> <tr> <th colspan="2">PRICE</th> </tr> </thead> <tbody> <tr> <td>1-9</td> <td>\$112.70</td> </tr> <tr> <td>10-24</td> <td>\$107.07</td> </tr> <tr> <td>25-49</td> <td>\$101.43</td> </tr> <tr> <td>50+</td> <td>\$96.92</td> </tr> </tbody> </table> <p>Low PIM NEW 7/16 DIN Female to 4.3-10 Male VSWR 1.08:1 to 6 GHz Model No: PE91391</p>	PRICE		1-9	\$112.70	10-24	\$107.07	25-49	\$101.43	50+	\$96.92	 <table border="1"> <thead> <tr> <th colspan="2">PRICE</th> </tr> </thead> <tbody> <tr> <td>1-24</td> <td>\$39.69</td> </tr> <tr> <td>25-49</td> <td>\$37.71</td> </tr> <tr> <td>50-99</td> <td>\$35.72</td> </tr> <tr> <td>100+</td> <td>\$34.13</td> </tr> </tbody> </table> <p>Low PIM NEW 7/16 DIN Female to 4.3-10 Female VSWR 1.25:1 to 6 GHz Model No: PE91471</p>	PRICE		1-24	\$39.69	25-49	\$37.71	50-99	\$35.72	100+	\$34.13	 <table border="1"> <thead> <tr> <th colspan="2">PRICE</th> </tr> </thead> <tbody> <tr> <td>1-24</td> <td>\$40.53</td> </tr> <tr> <td>25-49</td> <td>\$38.50</td> </tr> <tr> <td>50-99</td> <td>\$36.48</td> </tr> <tr> <td>100+</td> <td>\$34.86</td> </tr> </tbody> </table> <p>Low PIM NEW 7/16 DIN Female to QD 4.3-10 Female VSWR 1.2:1 to 6 GHz Model No: PE91473</p>	PRICE		1-24	\$40.53	25-49	\$38.50	50-99	\$36.48	100+	\$34.86		
PRICE																																																							
1-24	\$38.93																																																						
25-49	\$36.98																																																						
50-99	\$35.04																																																						
PRICE																																																							
1-24	\$55.13																																																						
25-49	\$52.37																																																						
50-99	\$49.62																																																						
100+	\$47.41																																																						
PRICE																																																							
1-9	\$112.70																																																						
10-24	\$107.07																																																						
25-49	\$101.43																																																						
50+	\$96.92																																																						
PRICE																																																							
1-24	\$39.69																																																						
25-49	\$37.71																																																						
50-99	\$35.72																																																						
100+	\$34.13																																																						
PRICE																																																							
1-24	\$40.53																																																						
25-49	\$38.50																																																						
50-99	\$36.48																																																						
100+	\$34.86																																																						
3	 <table border="1"> <thead> <tr> <th colspan="2">PRICE</th> </tr> </thead> <tbody> <tr> <td>1-9</td> <td>\$162.12</td> </tr> <tr> <td>10-24</td> <td>\$154.01</td> </tr> <tr> <td>25-49</td> <td>\$145.91</td> </tr> <tr> <td>50+</td> <td>\$139.42</td> </tr> </tbody> </table> <p>7/16 DIN Female to HN Male Model No: PE9559</p>	PRICE		1-9	\$162.12	10-24	\$154.01	25-49	\$145.91	50+	\$139.42	 <table border="1"> <thead> <tr> <th colspan="2">PRICE</th> </tr> </thead> <tbody> <tr> <td>1-24</td> <td>\$65.21</td> </tr> <tr> <td>25-49</td> <td>\$61.95</td> </tr> <tr> <td>50-99</td> <td>\$58.69</td> </tr> <tr> <td>100+</td> <td>\$56.08</td> </tr> </tbody> </table> <p>7/16 DIN Female to N Male VSWR 1.25:1 to 6 GHz Model No: PE91214</p>	PRICE		1-24	\$65.21	25-49	\$61.95	50-99	\$58.69	100+	\$56.08	 <table border="1"> <thead> <tr> <th colspan="2">PRICE</th> </tr> </thead> <tbody> <tr> <td>1-24</td> <td>\$48.04</td> </tr> <tr> <td>25-49</td> <td>\$45.64</td> </tr> <tr> <td>50-99</td> <td>\$43.24</td> </tr> <tr> <td>100+</td> <td>\$41.31</td> </tr> </tbody> </table> <p>7/16 DIN Female to N Male VSWR 1.25:1 to 6 GHz Model No: PE91251</p>	PRICE		1-24	\$48.04	25-49	\$45.64	50-99	\$43.24	100+	\$41.31	 <table border="1"> <thead> <tr> <th colspan="2">PRICE</th> </tr> </thead> <tbody> <tr> <td>1-24</td> <td>\$65.21</td> </tr> <tr> <td>25-49</td> <td>\$61.95</td> </tr> <tr> <td>50-99</td> <td>\$58.69</td> </tr> <tr> <td>100+</td> <td>\$56.08</td> </tr> </tbody> </table> <p>7/16 DIN Female to N Female VSWR 1.15:1 to 6 GHz Model No: PE91213</p>	PRICE		1-24	\$65.21	25-49	\$61.95	50-99	\$58.69	100+	\$56.08	 <table border="1"> <thead> <tr> <th colspan="2">PRICE</th> </tr> </thead> <tbody> <tr> <td>1-24</td> <td>\$49.26</td> </tr> <tr> <td>25-49</td> <td>\$46.80</td> </tr> <tr> <td>50-99</td> <td>\$44.33</td> </tr> <tr> <td>100+</td> <td>\$42.36</td> </tr> </tbody> </table> <p>7/16 DIN Female to N Female VSWR 1.25:1 to 6 GHz Model No: PE91250</p>	PRICE		1-24	\$49.26	25-49	\$46.80	50-99	\$44.33	100+	\$42.36
PRICE																																																							
1-9	\$162.12																																																						
10-24	\$154.01																																																						
25-49	\$145.91																																																						
50+	\$139.42																																																						
PRICE																																																							
1-24	\$65.21																																																						
25-49	\$61.95																																																						
50-99	\$58.69																																																						
100+	\$56.08																																																						
PRICE																																																							
1-24	\$48.04																																																						
25-49	\$45.64																																																						
50-99	\$43.24																																																						
100+	\$41.31																																																						
PRICE																																																							
1-24	\$65.21																																																						
25-49	\$61.95																																																						
50-99	\$58.69																																																						
100+	\$56.08																																																						
PRICE																																																							
1-24	\$49.26																																																						
25-49	\$46.80																																																						
50-99	\$44.33																																																						
100+	\$42.36																																																						
4	 <table border="1"> <thead> <tr> <th colspan="2">PRICE</th> </tr> </thead> <tbody> <tr> <td>1-24</td> <td>\$84.14</td> </tr> <tr> <td>25-49</td> <td>\$79.93</td> </tr> <tr> <td>50-99</td> <td>\$75.73</td> </tr> <tr> <td>100+</td> <td>\$72.36</td> </tr> </tbody> </table> <p>7/16 DIN Female to N Female Bulkhead VSWR 1.15:1 to 6 GHz Model No: PE91215</p>	PRICE		1-24	\$84.14	25-49	\$79.93	50-99	\$75.73	100+	\$72.36	 <table border="1"> <thead> <tr> <th colspan="2">PRICE</th> </tr> </thead> <tbody> <tr> <td>1-24</td> <td>\$44.42</td> </tr> <tr> <td>25-49</td> <td>\$42.20</td> </tr> <tr> <td>50-99</td> <td>\$39.98</td> </tr> <tr> <td>100+</td> <td>\$38.20</td> </tr> </tbody> </table> <p>7/16 DIN Female to N Female Bulkhead VSWR 1.25:1 to 6 GHz Model No: PE91252</p>	PRICE		1-24	\$44.42	25-49	\$42.20	50-99	\$39.98	100+	\$38.20	<p>10-32 In-Series</p> 		 <table border="1"> <thead> <tr> <th colspan="2">PRICE</th> </tr> </thead> <tbody> <tr> <td>1-24</td> <td>\$49.94</td> </tr> <tr> <td>25-49</td> <td>\$47.44</td> </tr> <tr> <td>50-99</td> <td>\$44.95</td> </tr> <tr> <td>100+</td> <td>\$42.95</td> </tr> </tbody> </table> <p>10-32 Female to 10-32 Female Model No: PE9756</p>	PRICE		1-24	\$49.94	25-49	\$47.44	50-99	\$44.95	100+	\$42.95	 <table border="1"> <thead> <tr> <th colspan="2">PRICE</th> </tr> </thead> <tbody> <tr> <td>1-24</td> <td>\$65.70</td> </tr> <tr> <td>25-49</td> <td>\$62.42</td> </tr> <tr> <td>50-99</td> <td>\$59.13</td> </tr> <tr> <td>100+</td> <td>\$56.50</td> </tr> </tbody> </table> <p>10-32 Female to 10-32 Female Bulkhead Model No: PE9757</p>	PRICE		1-24	\$65.70	25-49	\$62.42	50-99	\$59.13	100+	\$56.50									
PRICE																																																							
1-24	\$84.14																																																						
25-49	\$79.93																																																						
50-99	\$75.73																																																						
100+	\$72.36																																																						
PRICE																																																							
1-24	\$44.42																																																						
25-49	\$42.20																																																						
50-99	\$39.98																																																						
100+	\$38.20																																																						
PRICE																																																							
1-24	\$49.94																																																						
25-49	\$47.44																																																						
50-99	\$44.95																																																						
100+	\$42.95																																																						
PRICE																																																							
1-24	\$65.70																																																						
25-49	\$62.42																																																						
50-99	\$59.13																																																						
100+	\$56.50																																																						
5	<p>10-32 Between Series</p> 		 <table border="1"> <thead> <tr> <th colspan="2">PRICE</th> </tr> </thead> <tbody> <tr> <td>1-24</td> <td>\$76.30</td> </tr> <tr> <td>25-49</td> <td>\$72.49</td> </tr> <tr> <td>50-99</td> <td>\$68.67</td> </tr> <tr> <td>100+</td> <td>\$65.62</td> </tr> </tbody> </table> <p>10-32 Male to BNC Female Model No: PE9753</p>	PRICE		1-24	\$76.30	25-49	\$72.49	50-99	\$68.67	100+	\$65.62	 <table border="1"> <thead> <tr> <th colspan="2">PRICE</th> </tr> </thead> <tbody> <tr> <td>1-24</td> <td>\$100.58</td> </tr> <tr> <td>25-49</td> <td>\$95.55</td> </tr> <tr> <td>50-99</td> <td>\$90.52</td> </tr> <tr> <td>100+</td> <td>\$86.50</td> </tr> </tbody> </table> <p>10-32 Male to BNC Female Bulkhead Model No: PE9755</p>	PRICE		1-24	\$100.58	25-49	\$95.55	50-99	\$90.52	100+	\$86.50	 <table border="1"> <thead> <tr> <th colspan="2">PRICE</th> </tr> </thead> <tbody> <tr> <td>1-24</td> <td>\$62.87</td> </tr> <tr> <td>25-49</td> <td>\$59.73</td> </tr> <tr> <td>50-99</td> <td>\$56.58</td> </tr> <tr> <td>100+</td> <td>\$54.07</td> </tr> </tbody> </table> <p>10-32 Female to BNC Male Model No: PE9750</p>	PRICE		1-24	\$62.87	25-49	\$59.73	50-99	\$56.58	100+	\$54.07																				
PRICE																																																							
1-24	\$76.30																																																						
25-49	\$72.49																																																						
50-99	\$68.67																																																						
100+	\$65.62																																																						
PRICE																																																							
1-24	\$100.58																																																						
25-49	\$95.55																																																						
50-99	\$90.52																																																						
100+	\$86.50																																																						
PRICE																																																							
1-24	\$62.87																																																						
25-49	\$59.73																																																						
50-99	\$56.58																																																						
100+	\$54.07																																																						
6	 <table border="1"> <thead> <tr> <th colspan="2">PRICE</th> </tr> </thead> <tbody> <tr> <td>1-24</td> <td>\$68.53</td> </tr> <tr> <td>25-49</td> <td>\$65.10</td> </tr> <tr> <td>50-99</td> <td>\$61.68</td> </tr> <tr> <td>100+</td> <td>\$58.94</td> </tr> </tbody> </table> <p>10-32 Female to BNC Female Model No: PE9752</p>	PRICE		1-24	\$68.53	25-49	\$65.10	50-99	\$61.68	100+	\$58.94	 <table border="1"> <thead> <tr> <th colspan="2">PRICE</th> </tr> </thead> <tbody> <tr> <td>1-24</td> <td>\$70.94</td> </tr> <tr> <td>25-49</td> <td>\$67.39</td> </tr> <tr> <td>50-99</td> <td>\$63.85</td> </tr> <tr> <td>100+</td> <td>\$61.01</td> </tr> </tbody> </table> <p>10-32 Female to BNC Female Bulkhead Model No: PE9754</p>	PRICE		1-24	\$70.94	25-49	\$67.39	50-99	\$63.85	100+	\$61.01	<p>BMA In-Series</p> 		 <table border="1"> <thead> <tr> <th colspan="2">PRICE</th> </tr> </thead> <tbody> <tr> <td>1-24</td> <td>\$54.27</td> </tr> <tr> <td>25-49</td> <td>\$51.56</td> </tr> <tr> <td>50-99</td> <td>\$48.84</td> </tr> <tr> <td>100+</td> <td>\$46.67</td> </tr> </tbody> </table> <p>Slide-On BMA Jack to Slide-On BMA Jack VSWR 1.2:1 to 22 GHz Model No: PE91395</p>	PRICE		1-24	\$54.27	25-49	\$51.56	50-99	\$48.84	100+	\$46.67	<p>BMA Between Series</p> 																			
PRICE																																																							
1-24	\$68.53																																																						
25-49	\$65.10																																																						
50-99	\$61.68																																																						
100+	\$58.94																																																						
PRICE																																																							
1-24	\$70.94																																																						
25-49	\$67.39																																																						
50-99	\$63.85																																																						
100+	\$61.01																																																						
PRICE																																																							
1-24	\$54.27																																																						
25-49	\$51.56																																																						
50-99	\$48.84																																																						
100+	\$46.67																																																						
7	 <table border="1"> <thead> <tr> <th colspan="2">PRICE</th> </tr> </thead> <tbody> <tr> <td>1-9</td> <td>\$108.79</td> </tr> <tr> <td>10-24</td> <td>\$103.35</td> </tr> <tr> <td>25-49</td> <td>\$97.91</td> </tr> <tr> <td>NEW 50+</td> <td>\$93.56</td> </tr> </tbody> </table> <p>Slide-On BMA Plug to SMA Male VSWR 1.15:1 to 18 GHz Model No: PE91396</p>	PRICE		1-9	\$108.79	10-24	\$103.35	25-49	\$97.91	NEW 50+	\$93.56	 <table border="1"> <thead> <tr> <th colspan="2">PRICE</th> </tr> </thead> <tbody> <tr> <td>1-24</td> <td>\$103.58</td> </tr> <tr> <td>25-49</td> <td>\$98.40</td> </tr> <tr> <td>50-99</td> <td>\$93.22</td> </tr> <tr> <td>NEW 100+</td> <td>\$89.08</td> </tr> </tbody> </table> <p>Slide-On BMA Plug to SMA Male Bulkhead VSWR 1.15:1 to 18 GHz Model No: PE91401</p>	PRICE		1-24	\$103.58	25-49	\$98.40	50-99	\$93.22	NEW 100+	\$89.08	 <table border="1"> <thead> <tr> <th colspan="2">PRICE</th> </tr> </thead> <tbody> <tr> <td>1-9</td> <td>\$106.36</td> </tr> <tr> <td>10-24</td> <td>\$101.04</td> </tr> <tr> <td>25-49</td> <td>\$95.72</td> </tr> <tr> <td>NEW 50+</td> <td>\$91.47</td> </tr> </tbody> </table> <p>Slide-On BMA Plug to SMA Female VSWR 1.15:1 to 18 GHz Model No: PE91398</p>	PRICE		1-9	\$106.36	10-24	\$101.04	25-49	\$95.72	NEW 50+	\$91.47	 <table border="1"> <thead> <tr> <th colspan="2">PRICE</th> </tr> </thead> <tbody> <tr> <td>1-9</td> <td>\$126.54</td> </tr> <tr> <td>10-24</td> <td>\$120.21</td> </tr> <tr> <td>25-49</td> <td>\$113.89</td> </tr> <tr> <td>NEW 50+</td> <td>\$108.82</td> </tr> </tbody> </table> <p>Slide-On BMA Plug to SMA Female Bulkhead VSWR 1.15:1 to 18 GHz Model No: PE91402</p>	PRICE		1-9	\$126.54	10-24	\$120.21	25-49	\$113.89	NEW 50+	\$108.82	 <table border="1"> <thead> <tr> <th colspan="2">PRICE</th> </tr> </thead> <tbody> <tr> <td>1-9</td> <td>\$130.98</td> </tr> <tr> <td>10-24</td> <td>\$124.43</td> </tr> <tr> <td>25-49</td> <td>\$117.88</td> </tr> <tr> <td>NEW 50+</td> <td>\$112.64</td> </tr> </tbody> </table> <p>Slide-On BMA Jack to SMA Male VSWR 1.25:1 to 18 GHz Model No: PE91397</p>	PRICE		1-9	\$130.98	10-24	\$124.43	25-49	\$117.88	NEW 50+	\$112.64
PRICE																																																							
1-9	\$108.79																																																						
10-24	\$103.35																																																						
25-49	\$97.91																																																						
NEW 50+	\$93.56																																																						
PRICE																																																							
1-24	\$103.58																																																						
25-49	\$98.40																																																						
50-99	\$93.22																																																						
NEW 100+	\$89.08																																																						
PRICE																																																							
1-9	\$106.36																																																						
10-24	\$101.04																																																						
25-49	\$95.72																																																						
NEW 50+	\$91.47																																																						
PRICE																																																							
1-9	\$126.54																																																						
10-24	\$120.21																																																						
25-49	\$113.89																																																						
NEW 50+	\$108.82																																																						
PRICE																																																							
1-9	\$130.98																																																						
10-24	\$124.43																																																						
25-49	\$117.88																																																						
NEW 50+	\$112.64																																																						

ADAPTERS

See Adapter Locator on Pages 8-13

See Page 369 for Mounting Holes

	A	B	C	D	E																																																		
1	 <table border="1"> <thead> <tr> <th colspan="2">PRICE</th> </tr> </thead> <tbody> <tr> <td>1-9</td> <td>\$154.33</td> </tr> <tr> <td>10-24</td> <td>\$146.61</td> </tr> <tr> <td>25-49</td> <td>\$138.90</td> </tr> <tr> <td>NEW 50+</td> <td>\$132.72</td> </tr> </tbody> </table> <p>Slide-On BMA Jack to SMA Female VSWR 1.25:1 to 18 GHz Model No: PE91400</p>	PRICE		1-9	\$154.33	10-24	\$146.61	25-49	\$138.90	NEW 50+	\$132.72	 <table border="1"> <thead> <tr> <th colspan="2">PRICE</th> </tr> </thead> <tbody> <tr> <td>1-9</td> <td>\$139.83</td> </tr> <tr> <td>10-24</td> <td>\$132.84</td> </tr> <tr> <td>25-49</td> <td>\$125.85</td> </tr> <tr> <td>NEW 50+</td> <td>\$120.25</td> </tr> </tbody> </table> <p>Slide-On BMA Jack to SMA Female 2 Hole Flange VSWR 1.25:1 to 18 GHz Model No: PE91399</p>	PRICE		1-9	\$139.83	10-24	\$132.84	25-49	\$125.85	NEW 50+	\$120.25	<p>BNC In-Series</p> 		 <table border="1"> <thead> <tr> <th colspan="2">PRICE</th> </tr> </thead> <tbody> <tr> <td>1-24</td> <td>\$20.91</td> </tr> <tr> <td>25-49</td> <td>\$19.86</td> </tr> <tr> <td>50-99</td> <td>\$18.82</td> </tr> <tr> <td>100+</td> <td>\$17.98</td> </tr> </tbody> </table> <p>BNC Male to BNC Male VSWR 1.3:1 to 1,000 MHz Model No: PE9000</p>	PRICE		1-24	\$20.91	25-49	\$19.86	50-99	\$18.82	100+	\$17.98	 <table border="1"> <thead> <tr> <th colspan="2">PRICE</th> </tr> </thead> <tbody> <tr> <td>1-24</td> <td>\$56.85</td> </tr> <tr> <td>25-49</td> <td>\$54.01</td> </tr> <tr> <td>50-99</td> <td>\$51.17</td> </tr> <tr> <td>100+</td> <td>\$48.89</td> </tr> </tbody> </table> <p>BNC Male to BNC Male Right Angle Max. Freq. 4 GHz Model No: PE9758</p>	PRICE		1-24	\$56.85	25-49	\$54.01	50-99	\$51.17	100+	\$48.89									
	PRICE																																																						
1-9	\$154.33																																																						
10-24	\$146.61																																																						
25-49	\$138.90																																																						
NEW 50+	\$132.72																																																						
PRICE																																																							
1-9	\$139.83																																																						
10-24	\$132.84																																																						
25-49	\$125.85																																																						
NEW 50+	\$120.25																																																						
PRICE																																																							
1-24	\$20.91																																																						
25-49	\$19.86																																																						
50-99	\$18.82																																																						
100+	\$17.98																																																						
PRICE																																																							
1-24	\$56.85																																																						
25-49	\$54.01																																																						
50-99	\$51.17																																																						
100+	\$48.89																																																						
2	 <table border="1"> <thead> <tr> <th colspan="2">PRICE</th> </tr> </thead> <tbody> <tr> <td>1-24</td> <td>\$35.02</td> </tr> <tr> <td>25-49</td> <td>\$33.27</td> </tr> <tr> <td>50-99</td> <td>\$31.52</td> </tr> <tr> <td>100+</td> <td>\$30.12</td> </tr> </tbody> </table> <p>BNC Male to BNC Female VSWR 1.3:1 to 4 GHz Model No: PE9269</p>	PRICE		1-24	\$35.02	25-49	\$33.27	50-99	\$31.52	100+	\$30.12	 <table border="1"> <thead> <tr> <th colspan="2">PRICE</th> </tr> </thead> <tbody> <tr> <td>1-24</td> <td>\$27.06</td> </tr> <tr> <td>25-49</td> <td>\$25.71</td> </tr> <tr> <td>50-99</td> <td>\$24.35</td> </tr> <tr> <td>100+</td> <td>\$23.27</td> </tr> </tbody> </table> <p>BNC Male to BNC Female Right Angle Max. Freq. 4 GHz Model No: PE9085</p>	PRICE		1-24	\$27.06	25-49	\$25.71	50-99	\$24.35	100+	\$23.27	 <table border="1"> <thead> <tr> <th colspan="2">PRICE</th> </tr> </thead> <tbody> <tr> <td>1-24</td> <td>\$49.68</td> </tr> <tr> <td>25-49</td> <td>\$47.20</td> </tr> <tr> <td>50-99</td> <td>\$44.71</td> </tr> <tr> <td>100+</td> <td>\$42.72</td> </tr> </tbody> </table> <p>BNC Male to BNC Female Tee VSWR 2.1:1 to 100 MHz Model No: PE9174</p>	PRICE		1-24	\$49.68	25-49	\$47.20	50-99	\$44.71	100+	\$42.72	 <table border="1"> <thead> <tr> <th colspan="2">PRICE</th> </tr> </thead> <tbody> <tr> <td>1-24</td> <td>\$50.45</td> </tr> <tr> <td>25-49</td> <td>\$47.93</td> </tr> <tr> <td>50-99</td> <td>\$45.41</td> </tr> <tr> <td>100+</td> <td>\$43.39</td> </tr> </tbody> </table> <p>BNC Male to BNC Female Tee Max. Freq. 100 MHz Model No: PE9484</p>	PRICE		1-24	\$50.45	25-49	\$47.93	50-99	\$45.41	100+	\$43.39	 <table border="1"> <thead> <tr> <th colspan="2">PRICE</th> </tr> </thead> <tbody> <tr> <td>1-24</td> <td>\$20.92</td> </tr> <tr> <td>25-49</td> <td>\$19.87</td> </tr> <tr> <td>50-99</td> <td>\$18.83</td> </tr> <tr> <td>100+</td> <td>\$17.99</td> </tr> </tbody> </table> <p>BNC Female to BNC Male Tee Max. Freq. 4 GHz Model No: PE9001</p>	PRICE		1-24	\$20.92	25-49	\$19.87	50-99	\$18.83	100+	\$17.99
	PRICE																																																						
1-24	\$35.02																																																						
25-49	\$33.27																																																						
50-99	\$31.52																																																						
100+	\$30.12																																																						
PRICE																																																							
1-24	\$27.06																																																						
25-49	\$25.71																																																						
50-99	\$24.35																																																						
100+	\$23.27																																																						
PRICE																																																							
1-24	\$49.68																																																						
25-49	\$47.20																																																						
50-99	\$44.71																																																						
100+	\$42.72																																																						
PRICE																																																							
1-24	\$50.45																																																						
25-49	\$47.93																																																						
50-99	\$45.41																																																						
100+	\$43.39																																																						
PRICE																																																							
1-24	\$20.92																																																						
25-49	\$19.87																																																						
50-99	\$18.83																																																						
100+	\$17.99																																																						
3	 <table border="1"> <thead> <tr> <th colspan="2">PRICE</th> </tr> </thead> <tbody> <tr> <td>1-24</td> <td>\$11.51</td> </tr> <tr> <td>25-49</td> <td>\$10.93</td> </tr> <tr> <td>50-99</td> <td>\$10.36</td> </tr> <tr> <td>100+</td> <td>\$9.90</td> </tr> </tbody> </table> <p>BNC Female to BNC Female VSWR 1.3:1 to 4 GHz Model No: PE9084</p>	PRICE		1-24	\$11.51	25-49	\$10.93	50-99	\$10.36	100+	\$9.90	 <table border="1"> <thead> <tr> <th colspan="2">PRICE</th> </tr> </thead> <tbody> <tr> <td>1-24</td> <td>\$22.91</td> </tr> <tr> <td>25-49</td> <td>\$21.76</td> </tr> <tr> <td>50-99</td> <td>\$20.62</td> </tr> <tr> <td>100+</td> <td>\$19.70</td> </tr> </tbody> </table> <p>BNC Female to BNC Female Tee VSWR 2.1:1 to 100 MHz Model No: PE9003</p>	PRICE		1-24	\$22.91	25-49	\$21.76	50-99	\$20.62	100+	\$19.70	 <table border="1"> <thead> <tr> <th colspan="2">PRICE</th> </tr> </thead> <tbody> <tr> <td>1-24</td> <td>\$83.77</td> </tr> <tr> <td>25-49</td> <td>\$79.58</td> </tr> <tr> <td>50-99</td> <td>\$75.39</td> </tr> <tr> <td>100+</td> <td>\$72.04</td> </tr> </tbody> </table> <p>BNC Female to BNC Female Bulkhead-Mounting Hole B06 Model No: PE9420</p>	PRICE		1-24	\$83.77	25-49	\$79.58	50-99	\$75.39	100+	\$72.04	 <table border="1"> <thead> <tr> <th colspan="2">PRICE</th> </tr> </thead> <tbody> <tr> <td>1-24</td> <td>\$25.64</td> </tr> <tr> <td>25-49</td> <td>\$24.36</td> </tr> <tr> <td>50-99</td> <td>\$23.08</td> </tr> <tr> <td>100+</td> <td>\$22.05</td> </tr> </tbody> </table> <p>BNC Female to BNC Female Bulkhead VSWR 1.5:1 to 4 GHz Model No: PE9093</p>	PRICE		1-24	\$25.64	25-49	\$24.36	50-99	\$23.08	100+	\$22.05	 <table border="1"> <thead> <tr> <th colspan="2">PRICE</th> </tr> </thead> <tbody> <tr> <td>1-24</td> <td>\$28.22</td> </tr> <tr> <td>25-49</td> <td>\$26.81</td> </tr> <tr> <td>50-99</td> <td>\$25.40</td> </tr> <tr> <td>100+</td> <td>\$24.27</td> </tr> </tbody> </table> <p>BNC Female to BNC Female Bulkhead VSWR 1.5:1 to 4 GHz Model No: PE9172</p>	PRICE		1-24	\$28.22	25-49	\$26.81	50-99	\$25.40	100+	\$24.27
	PRICE																																																						
1-24	\$11.51																																																						
25-49	\$10.93																																																						
50-99	\$10.36																																																						
100+	\$9.90																																																						
PRICE																																																							
1-24	\$22.91																																																						
25-49	\$21.76																																																						
50-99	\$20.62																																																						
100+	\$19.70																																																						
PRICE																																																							
1-24	\$83.77																																																						
25-49	\$79.58																																																						
50-99	\$75.39																																																						
100+	\$72.04																																																						
PRICE																																																							
1-24	\$25.64																																																						
25-49	\$24.36																																																						
50-99	\$23.08																																																						
100+	\$22.05																																																						
PRICE																																																							
1-24	\$28.22																																																						
25-49	\$26.81																																																						
50-99	\$25.40																																																						
100+	\$24.27																																																						
4	 <table border="1"> <thead> <tr> <th colspan="2">PRICE</th> </tr> </thead> <tbody> <tr> <td>1-24</td> <td>\$21.24</td> </tr> <tr> <td>25-49</td> <td>\$20.18</td> </tr> <tr> <td>50-99</td> <td>\$19.12</td> </tr> <tr> <td>100+</td> <td>\$18.27</td> </tr> </tbody> </table> <p>BNC Female to BNC Female 4 Hole Flange-Mounting Hole A03 VSWR 1.3:1 to 4 GHz Model No: PE9106</p>	PRICE		1-24	\$21.24	25-49	\$20.18	50-99	\$19.12	100+	\$18.27	<p>Reverse Polarity BNC In-Series</p> 		 <table border="1"> <thead> <tr> <th colspan="2">PRICE</th> </tr> </thead> <tbody> <tr> <td>1-24</td> <td>\$45.04</td> </tr> <tr> <td>25-49</td> <td>\$42.79</td> </tr> <tr> <td>50-99</td> <td>\$40.54</td> </tr> <tr> <td>100+</td> <td>\$38.73</td> </tr> </tbody> </table> <p>BNC Male to Rev. Pol. BNC Female Model No: PE9530</p>	PRICE		1-24	\$45.04	25-49	\$42.79	50-99	\$40.54	100+	\$38.73	 <table border="1"> <thead> <tr> <th colspan="2">PRICE</th> </tr> </thead> <tbody> <tr> <td>1-24</td> <td>\$56.30</td> </tr> <tr> <td>25-49</td> <td>\$53.49</td> </tr> <tr> <td>50-99</td> <td>\$50.67</td> </tr> <tr> <td>100+</td> <td>\$48.42</td> </tr> </tbody> </table> <p>BNC Female to Rev. Pol. BNC Male Model No: PE9529</p>	PRICE		1-24	\$56.30	25-49	\$53.49	50-99	\$50.67	100+	\$48.42	<p>BNC Between Series</p> 																			
	PRICE																																																						
1-24	\$21.24																																																						
25-49	\$20.18																																																						
50-99	\$19.12																																																						
100+	\$18.27																																																						
PRICE																																																							
1-24	\$45.04																																																						
25-49	\$42.79																																																						
50-99	\$40.54																																																						
100+	\$38.73																																																						
PRICE																																																							
1-24	\$56.30																																																						
25-49	\$53.49																																																						
50-99	\$50.67																																																						
100+	\$48.42																																																						
5	 <table border="1"> <thead> <tr> <th colspan="2">PRICE</th> </tr> </thead> <tbody> <tr> <td>1-24</td> <td>\$24.15</td> </tr> <tr> <td>25-49</td> <td>\$22.94</td> </tr> <tr> <td>50-99</td> <td>\$21.74</td> </tr> <tr> <td>100+</td> <td>\$20.77</td> </tr> </tbody> </table> <p>BNC Male to Double Banana Binding Post Jack Model No: PE9011</p>	PRICE		1-24	\$24.15	25-49	\$22.94	50-99	\$21.74	100+	\$20.77	 <table border="1"> <thead> <tr> <th colspan="2">PRICE</th> </tr> </thead> <tbody> <tr> <td>1-24</td> <td>\$82.16</td> </tr> <tr> <td>25-49</td> <td>\$78.05</td> </tr> <tr> <td>50-99</td> <td>\$73.94</td> </tr> <tr> <td>100+</td> <td>\$70.66</td> </tr> </tbody> </table> <p>BNC Male to BNC Triax Female Model No: PE91104</p>	PRICE		1-24	\$82.16	25-49	\$78.05	50-99	\$73.94	100+	\$70.66	 <table border="1"> <thead> <tr> <th colspan="2">PRICE</th> </tr> </thead> <tbody> <tr> <td>1-24</td> <td>\$100.33</td> </tr> <tr> <td>25-49</td> <td>\$95.31</td> </tr> <tr> <td>50-99</td> <td>\$90.30</td> </tr> <tr> <td>100+</td> <td>\$86.28</td> </tr> </tbody> </table> <p>BNC Male to C Male Model No: PE9536</p>	PRICE		1-24	\$100.33	25-49	\$95.31	50-99	\$90.30	100+	\$86.28	 <table border="1"> <thead> <tr> <th colspan="2">PRICE</th> </tr> </thead> <tbody> <tr> <td>1-24</td> <td>\$56.51</td> </tr> <tr> <td>25-49</td> <td>\$53.68</td> </tr> <tr> <td>50-99</td> <td>\$50.86</td> </tr> <tr> <td>100+</td> <td>\$48.60</td> </tr> </tbody> </table> <p>BNC Male to C Female Model No: PE9109</p>	PRICE		1-24	\$56.51	25-49	\$53.68	50-99	\$50.86	100+	\$48.60	 <table border="1"> <thead> <tr> <th colspan="2">PRICE</th> </tr> </thead> <tbody> <tr> <td>1-24</td> <td>\$23.58</td> </tr> <tr> <td>25-49</td> <td>\$22.40</td> </tr> <tr> <td>50-99</td> <td>\$21.22</td> </tr> <tr> <td>100+</td> <td>\$20.28</td> </tr> </tbody> </table> <p>BNC Male to 75 Ohm F Male Model No: PE9152</p>	PRICE		1-24	\$23.58	25-49	\$22.40	50-99	\$21.22	100+	\$20.28
	PRICE																																																						
1-24	\$24.15																																																						
25-49	\$22.94																																																						
50-99	\$21.74																																																						
100+	\$20.77																																																						
PRICE																																																							
1-24	\$82.16																																																						
25-49	\$78.05																																																						
50-99	\$73.94																																																						
100+	\$70.66																																																						
PRICE																																																							
1-24	\$100.33																																																						
25-49	\$95.31																																																						
50-99	\$90.30																																																						
100+	\$86.28																																																						
PRICE																																																							
1-24	\$56.51																																																						
25-49	\$53.68																																																						
50-99	\$50.86																																																						
100+	\$48.60																																																						
PRICE																																																							
1-24	\$23.58																																																						
25-49	\$22.40																																																						
50-99	\$21.22																																																						
100+	\$20.28																																																						
6	 <table border="1"> <thead> <tr> <th colspan="2">PRICE</th> </tr> </thead> <tbody> <tr> <td>1-24</td> <td>\$29.72</td> </tr> <tr> <td>25-49</td> <td>\$28.23</td> </tr> <tr> <td>50-99</td> <td>\$26.75</td> </tr> <tr> <td>100+</td> <td>\$25.56</td> </tr> </tbody> </table> <p>BNC Male to 75 Ohm F Female VSWR 1.5:1 to 300 MHz Model No: PE9150</p>	PRICE		1-24	\$29.72	25-49	\$28.23	50-99	\$26.75	100+	\$25.56	 <table border="1"> <thead> <tr> <th colspan="2">PRICE</th> </tr> </thead> <tbody> <tr> <td>1-9</td> <td>\$112.38</td> </tr> <tr> <td>10-24</td> <td>\$106.76</td> </tr> <tr> <td>25-49</td> <td>\$101.14</td> </tr> <tr> <td>50+</td> <td>\$96.65</td> </tr> </tbody> </table> <p>BNC Male to MHV Female Model No: PE9406</p>	PRICE		1-9	\$112.38	10-24	\$106.76	25-49	\$101.14	50+	\$96.65	 <table border="1"> <thead> <tr> <th colspan="2">PRICE</th> </tr> </thead> <tbody> <tr> <td>1-24</td> <td>\$20.78</td> </tr> <tr> <td>25-49</td> <td>\$19.74</td> </tr> <tr> <td>50-99</td> <td>\$18.70</td> </tr> <tr> <td>100+</td> <td>\$17.87</td> </tr> </tbody> </table> <p>BNC Male to 75 Ohm Push-On RCA Jack Max. Freq. 250 MHz Model No: PE9171</p>	PRICE		1-24	\$20.78	25-49	\$19.74	50-99	\$18.70	100+	\$17.87	 <table border="1"> <thead> <tr> <th colspan="2">PRICE</th> </tr> </thead> <tbody> <tr> <td>1-24</td> <td>\$68.65</td> </tr> <tr> <td>25-49</td> <td>\$65.22</td> </tr> <tr> <td>50-99</td> <td>\$61.79</td> </tr> <tr> <td>100+</td> <td>\$59.04</td> </tr> </tbody> </table> <p>BNC Male to 75 Ohm SMB Plug Model No: PE9230</p>	PRICE		1-24	\$68.65	25-49	\$65.22	50-99	\$61.79	100+	\$59.04	 <table border="1"> <thead> <tr> <th colspan="2">PRICE</th> </tr> </thead> <tbody> <tr> <td>1-24</td> <td>\$66.98</td> </tr> <tr> <td>25-49</td> <td>\$63.63</td> </tr> <tr> <td>50-99</td> <td>\$60.28</td> </tr> <tr> <td>100+</td> <td>\$57.60</td> </tr> </tbody> </table> <p>BNC Male to 75 Ohm SMC Plug Model No: PE9234</p>	PRICE		1-24	\$66.98	25-49	\$63.63	50-99	\$60.28	100+	\$57.60
	PRICE																																																						
1-24	\$29.72																																																						
25-49	\$28.23																																																						
50-99	\$26.75																																																						
100+	\$25.56																																																						
PRICE																																																							
1-9	\$112.38																																																						
10-24	\$106.76																																																						
25-49	\$101.14																																																						
50+	\$96.65																																																						
PRICE																																																							
1-24	\$20.78																																																						
25-49	\$19.74																																																						
50-99	\$18.70																																																						
100+	\$17.87																																																						
PRICE																																																							
1-24	\$68.65																																																						
25-49	\$65.22																																																						
50-99	\$61.79																																																						
100+	\$59.04																																																						
PRICE																																																							
1-24	\$66.98																																																						
25-49	\$63.63																																																						
50-99	\$60.28																																																						
100+	\$57.60																																																						
7	 <table border="1"> <thead> <tr> <th colspan="2">PRICE</th> </tr> </thead> <tbody> <tr> <td>1-24</td> <td>\$91.01</td> </tr> <tr> <td>25-49</td> <td>\$86.46</td> </tr> <tr> <td>50-99</td> <td>\$81.91</td> </tr> <tr> <td>100+</td> <td>\$78.27</td> </tr> </tbody> </table> <p>BNC Male to 75 Ohm SMC Jack Model No: PE91044</p>	PRICE		1-24	\$91.01	25-49	\$86.46	50-99	\$81.91	100+	\$78.27	 <table border="1"> <thead> <tr> <th colspan="2">PRICE</th> </tr> </thead> <tbody> <tr> <td>1-24</td> <td>\$40.37</td> </tr> <tr> <td>25-49</td> <td>\$38.35</td> </tr> <tr> <td>50-99</td> <td>\$36.33</td> </tr> <tr> <td>100+</td> <td>\$34.72</td> </tr> </tbody> </table> <p>BNC Female to C Male VSWR 1.3:1 to 4 GHz Model No: PE9087</p>	PRICE		1-24	\$40.37	25-49	\$38.35	50-99	\$36.33	100+	\$34.72	 <table border="1"> <thead> <tr> <th colspan="2">PRICE</th> </tr> </thead> <tbody> <tr> <td>1-24</td> <td>\$97.86</td> </tr> <tr> <td>25-49</td> <td>\$92.97</td> </tr> <tr> <td>50-99</td> <td>\$88.07</td> </tr> <tr> <td>100+</td> <td>\$84.16</td> </tr> </tbody> </table> <p>BNC Female to C Female Model No: PE9537</p>	PRICE		1-24	\$97.86	25-49	\$92.97	50-99	\$88.07	100+	\$84.16	 <table border="1"> <thead> <tr> <th colspan="2">PRICE</th> </tr> </thead> <tbody> <tr> <td>1-24</td> <td>\$99.02</td> </tr> <tr> <td>25-49</td> <td>\$94.07</td> </tr> <tr> <td>50-99</td> <td>\$89.12</td> </tr> <tr> <td>100+</td> <td>\$85.16</td> </tr> </tbody> </table> <p>BNC Female to C Female Bulkhead-Mounting Hole G01 Model No: PE9204</p>	PRICE		1-24	\$99.02	25-49	\$94.07	50-99	\$89.12	100+	\$85.16	 <table border="1"> <thead> <tr> <th colspan="2">PRICE</th> </tr> </thead> <tbody> <tr> <td>1-24</td> <td>\$23.36</td> </tr> <tr> <td>25-49</td> <td>\$22.19</td> </tr> <tr> <td>50-99</td> <td>\$21.02</td> </tr> <tr> <td>100+</td> <td>\$20.09</td> </tr> </tbody> </table> <p>BNC Female to 75 Ohm F Male VSWR 1.3:1 to 500 MHz Model No: PE9151</p>	PRICE		1-24	\$23.36	25-49	\$22.19	50-99	\$21.02	100+	\$20.09
	PRICE																																																						
1-24	\$91.01																																																						
25-49	\$86.46																																																						
50-99	\$81.91																																																						
100+	\$78.27																																																						
PRICE																																																							
1-24	\$40.37																																																						
25-49	\$38.35																																																						
50-99	\$36.33																																																						
100+	\$34.72																																																						
PRICE																																																							
1-24	\$97.86																																																						
25-49	\$92.97																																																						
50-99	\$88.07																																																						
100+	\$84.16																																																						
PRICE																																																							
1-24	\$99.02																																																						
25-49	\$94.07																																																						
50-99	\$89.12																																																						
100+	\$85.16																																																						
PRICE																																																							
1-24	\$23.36																																																						
25-49	\$22.19																																																						
50-99	\$21.02																																																						
100+	\$20.09																																																						

ADAPTERS

See Adapter Locator on Pages 8-13

See Page 369 for Mounting Holes

Adapters

See Our Website For Current Pricing & Real-Time Stock Availability!

	A	B	C	D	E																																																		
1	 <table border="1"> <thead> <tr> <th colspan="2">PRICE</th> </tr> </thead> <tbody> <tr> <td>1-24</td> <td>\$18.21</td> </tr> <tr> <td>25-49</td> <td>\$17.30</td> </tr> <tr> <td>50-99</td> <td>\$16.39</td> </tr> <tr> <td>100+</td> <td>\$15.66</td> </tr> </tbody> </table> <p>BNC Female to 75 Ohm F Female</p> <p>Model No: PE9153</p>	PRICE		1-24	\$18.21	25-49	\$17.30	50-99	\$16.39	100+	\$15.66	 <table border="1"> <thead> <tr> <th colspan="2">PRICE</th> </tr> </thead> <tbody> <tr> <td>1-24</td> <td>\$18.53</td> </tr> <tr> <td>25-49</td> <td>\$17.60</td> </tr> <tr> <td>50-99</td> <td>\$16.68</td> </tr> <tr> <td>100+</td> <td>\$15.94</td> </tr> </tbody> </table> <p>BNC Female to 75 Ohm RCA Plug</p> <p>Max. Freq. 250 MHz</p> <p>Model No: PE9158</p>	PRICE		1-24	\$18.53	25-49	\$17.60	50-99	\$16.68	100+	\$15.94	 <table border="1"> <thead> <tr> <th colspan="2">PRICE</th> </tr> </thead> <tbody> <tr> <td>1-24</td> <td>\$13.36</td> </tr> <tr> <td>25-49</td> <td>\$12.69</td> </tr> <tr> <td>50-99</td> <td>\$12.02</td> </tr> <tr> <td>100+</td> <td>\$11.49</td> </tr> </tbody> </table> <p>BNC Female to 75 Ohm RCA Jack</p> <p>Max. Freq. 250 MHz</p> <p>Model No: PE9015</p>	PRICE		1-24	\$13.36	25-49	\$12.69	50-99	\$12.02	100+	\$11.49	 <table border="1"> <thead> <tr> <th colspan="2">PRICE</th> </tr> </thead> <tbody> <tr> <td>1-24</td> <td>\$66.06</td> </tr> <tr> <td>25-49</td> <td>\$62.76</td> </tr> <tr> <td>50-99</td> <td>\$59.45</td> </tr> <tr> <td>100+</td> <td>\$56.81</td> </tr> </tbody> </table> <p>BNC Female to 75 Ohm SMB Jack</p> <p>VSWR 1.2:1 to 4 GHz</p> <p>Model No: PE9231</p>	PRICE		1-24	\$66.06	25-49	\$62.76	50-99	\$59.45	100+	\$56.81	 <table border="1"> <thead> <tr> <th colspan="2">PRICE</th> </tr> </thead> <tbody> <tr> <td>1-24</td> <td>\$74.67</td> </tr> <tr> <td>25-49</td> <td>\$70.94</td> </tr> <tr> <td>50-99</td> <td>\$67.20</td> </tr> <tr> <td>100+</td> <td>\$64.22</td> </tr> </tbody> </table> <p>BNC Female to 75 Ohm SMC Plug</p> <p>Model No: PE9236</p>	PRICE		1-24	\$74.67	25-49	\$70.94	50-99	\$67.20	100+	\$64.22
PRICE																																																							
1-24	\$18.21																																																						
25-49	\$17.30																																																						
50-99	\$16.39																																																						
100+	\$15.66																																																						
PRICE																																																							
1-24	\$18.53																																																						
25-49	\$17.60																																																						
50-99	\$16.68																																																						
100+	\$15.94																																																						
PRICE																																																							
1-24	\$13.36																																																						
25-49	\$12.69																																																						
50-99	\$12.02																																																						
100+	\$11.49																																																						
PRICE																																																							
1-24	\$66.06																																																						
25-49	\$62.76																																																						
50-99	\$59.45																																																						
100+	\$56.81																																																						
PRICE																																																							
1-24	\$74.67																																																						
25-49	\$70.94																																																						
50-99	\$67.20																																																						
100+	\$64.22																																																						
2	<p>C In-Series</p> <p>→</p>	 <table border="1"> <thead> <tr> <th colspan="2">PRICE</th> </tr> </thead> <tbody> <tr> <td>1-24</td> <td>\$115.39</td> </tr> <tr> <td>25-49</td> <td>\$109.62</td> </tr> <tr> <td>50-99</td> <td>\$103.85</td> </tr> <tr> <td>100+</td> <td>\$99.24</td> </tr> </tbody> </table> <p>C Male to C Male</p> <p>Model No: PE9300</p>	PRICE		1-24	\$115.39	25-49	\$109.62	50-99	\$103.85	100+	\$99.24	 <table border="1"> <thead> <tr> <th colspan="2">PRICE</th> </tr> </thead> <tbody> <tr> <td>1-24</td> <td>\$90.81</td> </tr> <tr> <td>25-49</td> <td>\$86.27</td> </tr> <tr> <td>50-99</td> <td>\$81.73</td> </tr> <tr> <td>100+</td> <td>\$78.10</td> </tr> </tbody> </table> <p>C Male to C Female Right Angle</p> <p>Model No: PE9293</p>	PRICE		1-24	\$90.81	25-49	\$86.27	50-99	\$81.73	100+	\$78.10	 <table border="1"> <thead> <tr> <th colspan="2">PRICE</th> </tr> </thead> <tbody> <tr> <td>1-24</td> <td>\$89.46</td> </tr> <tr> <td>25-49</td> <td>\$84.99</td> </tr> <tr> <td>50-99</td> <td>\$80.51</td> </tr> <tr> <td>100+</td> <td>\$76.94</td> </tr> </tbody> </table> <p>C Female to C Male Tee</p> <p>Model No: PE9207</p>	PRICE		1-24	\$89.46	25-49	\$84.99	50-99	\$80.51	100+	\$76.94	 <table border="1"> <thead> <tr> <th colspan="2">PRICE</th> </tr> </thead> <tbody> <tr> <td>1-24</td> <td>\$49.13</td> </tr> <tr> <td>25-49</td> <td>\$46.67</td> </tr> <tr> <td>50-99</td> <td>\$44.22</td> </tr> <tr> <td>100+</td> <td>\$42.25</td> </tr> </tbody> </table> <p>C Female to C Female</p> <p>Model No: PE9208</p>	PRICE		1-24	\$49.13	25-49	\$46.67	50-99	\$44.22	100+	\$42.25										
PRICE																																																							
1-24	\$115.39																																																						
25-49	\$109.62																																																						
50-99	\$103.85																																																						
100+	\$99.24																																																						
PRICE																																																							
1-24	\$90.81																																																						
25-49	\$86.27																																																						
50-99	\$81.73																																																						
100+	\$78.10																																																						
PRICE																																																							
1-24	\$89.46																																																						
25-49	\$84.99																																																						
50-99	\$80.51																																																						
100+	\$76.94																																																						
PRICE																																																							
1-24	\$49.13																																																						
25-49	\$46.67																																																						
50-99	\$44.22																																																						
100+	\$42.25																																																						
3	 <table border="1"> <thead> <tr> <th colspan="2">PRICE</th> </tr> </thead> <tbody> <tr> <td>1-24</td> <td>\$119.65</td> </tr> <tr> <td>25-49</td> <td>\$113.67</td> </tr> <tr> <td>50-99</td> <td>\$107.69</td> </tr> <tr> <td>100+</td> <td>\$102.90</td> </tr> </tbody> </table> <p>C Female to C Female Tee</p> <p>Model No: PE9294</p>	PRICE		1-24	\$119.65	25-49	\$113.67	50-99	\$107.69	100+	\$102.90	 <table border="1"> <thead> <tr> <th colspan="2">PRICE</th> </tr> </thead> <tbody> <tr> <td>1-24</td> <td>\$117.32</td> </tr> <tr> <td>25-49</td> <td>\$111.45</td> </tr> <tr> <td>50-99</td> <td>\$105.59</td> </tr> <tr> <td>100+</td> <td>\$100.90</td> </tr> </tbody> </table> <p>C Female to C Female Bulkhead-Mounting Hole B07</p> <p>Model No: PE9186</p>	PRICE		1-24	\$117.32	25-49	\$111.45	50-99	\$105.59	100+	\$100.90	<p>D-Sub In-Series</p> <p>→</p>	 <table border="1"> <thead> <tr> <th colspan="2">PRICE</th> </tr> </thead> <tbody> <tr> <td>1-24</td> <td>\$50.01</td> </tr> <tr> <td>25-49</td> <td>\$47.51</td> </tr> <tr> <td>50-99</td> <td>\$45.01</td> </tr> <tr> <td>100+</td> <td>\$43.01</td> </tr> </tbody> </table> <p>D-Sub Plug to D-Sub Plug</p> <p>Model No: PE9688</p>	PRICE		1-24	\$50.01	25-49	\$47.51	50-99	\$45.01	100+	\$43.01	 <table border="1"> <thead> <tr> <th colspan="2">PRICE</th> </tr> </thead> <tbody> <tr> <td>1-24</td> <td>\$49.39</td> </tr> <tr> <td>25-49</td> <td>\$46.92</td> </tr> <tr> <td>50-99</td> <td>\$44.45</td> </tr> <tr> <td>100+</td> <td>\$42.48</td> </tr> </tbody> </table> <p>D-Sub Plug to D-Sub Receptacle</p> <p>Model No: PE9687</p>	PRICE		1-24	\$49.39	25-49	\$46.92	50-99	\$44.45	100+	\$42.48										
PRICE																																																							
1-24	\$119.65																																																						
25-49	\$113.67																																																						
50-99	\$107.69																																																						
100+	\$102.90																																																						
PRICE																																																							
1-24	\$117.32																																																						
25-49	\$111.45																																																						
50-99	\$105.59																																																						
100+	\$100.90																																																						
PRICE																																																							
1-24	\$50.01																																																						
25-49	\$47.51																																																						
50-99	\$45.01																																																						
100+	\$43.01																																																						
PRICE																																																							
1-24	\$49.39																																																						
25-49	\$46.92																																																						
50-99	\$44.45																																																						
100+	\$42.48																																																						
4	 <table border="1"> <thead> <tr> <th colspan="2">PRICE</th> </tr> </thead> <tbody> <tr> <td>1-24</td> <td>\$70.46</td> </tr> <tr> <td>25-49</td> <td>\$66.94</td> </tr> <tr> <td>50-99</td> <td>\$63.41</td> </tr> <tr> <td>100+</td> <td>\$60.60</td> </tr> </tbody> </table> <p>D-Sub Receptacle to D-Sub Receptacle</p> <p>Model No: PE9689</p>	PRICE		1-24	\$70.46	25-49	\$66.94	50-99	\$63.41	100+	\$60.60	<p>FME In-Series</p> <p>→</p>	 <table border="1"> <thead> <tr> <th colspan="2">PRICE</th> </tr> </thead> <tbody> <tr> <td>1-24</td> <td>\$20.43</td> </tr> <tr> <td>25-49</td> <td>\$19.41</td> </tr> <tr> <td>50-99</td> <td>\$18.39</td> </tr> <tr> <td>100+</td> <td>\$17.57</td> </tr> </tbody> </table> <p>FME Plug to FME Plug</p> <p>Model No: PE9696</p>	PRICE		1-24	\$20.43	25-49	\$19.41	50-99	\$18.39	100+	\$17.57	<p>FME Between Series</p> <p>→</p>	 <table border="1"> <thead> <tr> <th colspan="2">PRICE</th> </tr> </thead> <tbody> <tr> <td>1-24</td> <td>\$20.43</td> </tr> <tr> <td>25-49</td> <td>\$19.41</td> </tr> <tr> <td>50-99</td> <td>\$18.39</td> </tr> <tr> <td>100+</td> <td>\$17.57</td> </tr> </tbody> </table> <p>FME Plug to BNC Male</p> <p>Model No: PE9697</p>	PRICE		1-24	\$20.43	25-49	\$19.41	50-99	\$18.39	100+	\$17.57																				
PRICE																																																							
1-24	\$70.46																																																						
25-49	\$66.94																																																						
50-99	\$63.41																																																						
100+	\$60.60																																																						
PRICE																																																							
1-24	\$20.43																																																						
25-49	\$19.41																																																						
50-99	\$18.39																																																						
100+	\$17.57																																																						
PRICE																																																							
1-24	\$20.43																																																						
25-49	\$19.41																																																						
50-99	\$18.39																																																						
100+	\$17.57																																																						
5	 <table border="1"> <thead> <tr> <th colspan="2">PRICE</th> </tr> </thead> <tbody> <tr> <td>1-24</td> <td>\$20.86</td> </tr> <tr> <td>25-49</td> <td>\$19.82</td> </tr> <tr> <td>50-99</td> <td>\$18.77</td> </tr> <tr> <td>100+</td> <td>\$17.94</td> </tr> </tbody> </table> <p>FME Plug to BNC Male Right Angle</p> <p>Model No: PE9698</p>	PRICE		1-24	\$20.86	25-49	\$19.82	50-99	\$18.77	100+	\$17.94	 <table border="1"> <thead> <tr> <th colspan="2">PRICE</th> </tr> </thead> <tbody> <tr> <td>1-24</td> <td>\$20.43</td> </tr> <tr> <td>25-49</td> <td>\$19.41</td> </tr> <tr> <td>50-99</td> <td>\$18.39</td> </tr> <tr> <td>100+</td> <td>\$17.57</td> </tr> </tbody> </table> <p>FME Jack to BNC Male</p> <p>Model No: PE9711</p>	PRICE		1-24	\$20.43	25-49	\$19.41	50-99	\$18.39	100+	\$17.57	 <table border="1"> <thead> <tr> <th colspan="2">PRICE</th> </tr> </thead> <tbody> <tr> <td>1-24</td> <td>\$16.30</td> </tr> <tr> <td>25-49</td> <td>\$15.49</td> </tr> <tr> <td>50-99</td> <td>\$14.67</td> </tr> <tr> <td>100+</td> <td>\$14.02</td> </tr> </tbody> </table> <p>FME Jack to BNC Female</p> <p>Model No: PE9712</p>	PRICE		1-24	\$16.30	25-49	\$15.49	50-99	\$14.67	100+	\$14.02	<p>GR874 In-Series</p> <p>→</p>	 <table border="1"> <thead> <tr> <th colspan="2">PRICE</th> </tr> </thead> <tbody> <tr> <td>1-9</td> <td>\$345.96</td> </tr> <tr> <td>10-24</td> <td>\$328.66</td> </tr> <tr> <td>25-49</td> <td>\$311.36</td> </tr> <tr> <td>50+</td> <td>\$297.53</td> </tr> </tbody> </table> <p>GR874 Sexless to GR874 Sexless Right Angle</p> <p>Model No: PE9286</p>	PRICE		1-9	\$345.96	10-24	\$328.66	25-49	\$311.36	50+	\$297.53										
PRICE																																																							
1-24	\$20.86																																																						
25-49	\$19.82																																																						
50-99	\$18.77																																																						
100+	\$17.94																																																						
PRICE																																																							
1-24	\$20.43																																																						
25-49	\$19.41																																																						
50-99	\$18.39																																																						
100+	\$17.57																																																						
PRICE																																																							
1-24	\$16.30																																																						
25-49	\$15.49																																																						
50-99	\$14.67																																																						
100+	\$14.02																																																						
PRICE																																																							
1-9	\$345.96																																																						
10-24	\$328.66																																																						
25-49	\$311.36																																																						
50+	\$297.53																																																						
6	 <table border="1"> <thead> <tr> <th colspan="2">PRICE</th> </tr> </thead> <tbody> <tr> <td>1-9</td> <td>\$373.83</td> </tr> <tr> <td>10-24</td> <td>\$355.14</td> </tr> <tr> <td>25-49</td> <td>\$336.45</td> </tr> <tr> <td>50+</td> <td>\$321.49</td> </tr> </tbody> </table> <p>GR874 Sexless to GR874 Sexless Tee</p> <p>Model No: PE9285</p>	PRICE		1-9	\$373.83	10-24	\$355.14	25-49	\$336.45	50+	\$321.49	<p>GR874 Between Series</p> <p>→</p>	 <table border="1"> <thead> <tr> <th colspan="2">PRICE</th> </tr> </thead> <tbody> <tr> <td>1-9</td> <td>\$163.58</td> </tr> <tr> <td>10-24</td> <td>\$155.40</td> </tr> <tr> <td>25-49</td> <td>\$147.22</td> </tr> <tr> <td>50+</td> <td>\$140.68</td> </tr> </tbody> </table> <p>GR874 Sexless to BNC Male</p> <p>Model No: PE9223</p>	PRICE		1-9	\$163.58	10-24	\$155.40	25-49	\$147.22	50+	\$140.68	 <table border="1"> <thead> <tr> <th colspan="2">PRICE</th> </tr> </thead> <tbody> <tr> <td>1-9</td> <td>\$169.97</td> </tr> <tr> <td>10-24</td> <td>\$161.47</td> </tr> <tr> <td>25-49</td> <td>\$152.97</td> </tr> <tr> <td>50+</td> <td>\$146.17</td> </tr> </tbody> </table> <p>GR874 Sexless to BNC Female</p> <p>Model No: PE9222</p>	PRICE		1-9	\$169.97	10-24	\$161.47	25-49	\$152.97	50+	\$146.17	 <table border="1"> <thead> <tr> <th colspan="2">PRICE</th> </tr> </thead> <tbody> <tr> <td>1-9</td> <td>\$172.86</td> </tr> <tr> <td>10-24</td> <td>\$164.22</td> </tr> <tr> <td>25-49</td> <td>\$155.57</td> </tr> <tr> <td>50+</td> <td>\$148.66</td> </tr> </tbody> </table> <p>GR874 Sexless to C Female</p> <p>Model No: PE9301</p>	PRICE		1-9	\$172.86	10-24	\$164.22	25-49	\$155.57	50+	\$148.66										
PRICE																																																							
1-9	\$373.83																																																						
10-24	\$355.14																																																						
25-49	\$336.45																																																						
50+	\$321.49																																																						
PRICE																																																							
1-9	\$163.58																																																						
10-24	\$155.40																																																						
25-49	\$147.22																																																						
50+	\$140.68																																																						
PRICE																																																							
1-9	\$169.97																																																						
10-24	\$161.47																																																						
25-49	\$152.97																																																						
50+	\$146.17																																																						
PRICE																																																							
1-9	\$172.86																																																						
10-24	\$164.22																																																						
25-49	\$155.57																																																						
50+	\$148.66																																																						
7	<p>HN In-Series</p> <p>→</p>	 <table border="1"> <thead> <tr> <th colspan="2">PRICE</th> </tr> </thead> <tbody> <tr> <td>1-24</td> <td>\$58.67</td> </tr> <tr> <td>25-49</td> <td>\$55.74</td> </tr> <tr> <td>50-99</td> <td>\$52.80</td> </tr> <tr> <td>100+</td> <td>\$50.46</td> </tr> </tbody> </table> <p>HN Male to HN Male</p> <p>VSWR 1.4:1 to 3 GHz</p> <p>Model No: PE9210</p>	PRICE		1-24	\$58.67	25-49	\$55.74	50-99	\$52.80	100+	\$50.46	 <table border="1"> <thead> <tr> <th colspan="2">PRICE</th> </tr> </thead> <tbody> <tr> <td>1-9</td> <td>\$156.40</td> </tr> <tr> <td>10-24</td> <td>\$148.58</td> </tr> <tr> <td>25-49</td> <td>\$140.76</td> </tr> <tr> <td>50+</td> <td>\$134.50</td> </tr> </tbody> </table> <p>HN Male to HN Male Right Angle</p> <p>Model No: PE9577</p>	PRICE		1-9	\$156.40	10-24	\$148.58	25-49	\$140.76	50+	\$134.50	 <table border="1"> <thead> <tr> <th colspan="2">PRICE</th> </tr> </thead> <tbody> <tr> <td>1-24</td> <td>\$96.14</td> </tr> <tr> <td>25-49</td> <td>\$91.33</td> </tr> <tr> <td>50-99</td> <td>\$86.53</td> </tr> <tr> <td>100+</td> <td>\$82.68</td> </tr> </tbody> </table> <p>HN Male to HN Female</p> <p>Model No: PE9576</p>	PRICE		1-24	\$96.14	25-49	\$91.33	50-99	\$86.53	100+	\$82.68	 <table border="1"> <thead> <tr> <th colspan="2">PRICE</th> </tr> </thead> <tbody> <tr> <td>1-24</td> <td>\$65.82</td> </tr> <tr> <td>25-49</td> <td>\$62.53</td> </tr> <tr> <td>50-99</td> <td>\$59.24</td> </tr> <tr> <td>100+</td> <td>\$56.61</td> </tr> </tbody> </table> <p>HN Male to HN Female Right Angle</p> <p>VSWR 1.5:1 to 3 GHz</p> <p>Model No: PE9205</p>	PRICE		1-24	\$65.82	25-49	\$62.53	50-99	\$59.24	100+	\$56.61										
PRICE																																																							
1-24	\$58.67																																																						
25-49	\$55.74																																																						
50-99	\$52.80																																																						
100+	\$50.46																																																						
PRICE																																																							
1-9	\$156.40																																																						
10-24	\$148.58																																																						
25-49	\$140.76																																																						
50+	\$134.50																																																						
PRICE																																																							
1-24	\$96.14																																																						
25-49	\$91.33																																																						
50-99	\$86.53																																																						
100+	\$82.68																																																						
PRICE																																																							
1-24	\$65.82																																																						
25-49	\$62.53																																																						
50-99	\$59.24																																																						
100+	\$56.61																																																						

ADAPTERS

See Adapter Locator on Pages 8-13

See Page 369 for Mounting Holes

	A	B	C	D	E																																																		
1	 <table border="1"> <thead> <tr> <th colspan="2">PRICE</th> </tr> </thead> <tbody> <tr> <td>1-9</td> <td>\$195.25</td> </tr> <tr> <td>10-24</td> <td>\$185.49</td> </tr> <tr> <td>25-49</td> <td>\$175.73</td> </tr> <tr> <td>50+</td> <td>\$167.92</td> </tr> </tbody> </table> <p>HN Male to HN Female Tee</p> <p>Model No: PE9578</p>	PRICE		1-9	\$195.25	10-24	\$185.49	25-49	\$175.73	50+	\$167.92	 <table border="1"> <thead> <tr> <th colspan="2">PRICE</th> </tr> </thead> <tbody> <tr> <td>1-9</td> <td>\$138.56</td> </tr> <tr> <td>10-24</td> <td>\$131.63</td> </tr> <tr> <td>25-49</td> <td>\$124.70</td> </tr> <tr> <td>50+</td> <td>\$119.16</td> </tr> </tbody> </table> <p>HN Female to HN Male Tee</p> <p>Model No: PE9575</p>	PRICE		1-9	\$138.56	10-24	\$131.63	25-49	\$124.70	50+	\$119.16	 <table border="1"> <thead> <tr> <th colspan="2">PRICE</th> </tr> </thead> <tbody> <tr> <td>1-24</td> <td>\$58.88</td> </tr> <tr> <td>25-49</td> <td>\$55.94</td> </tr> <tr> <td>50-99</td> <td>\$52.99</td> </tr> <tr> <td>100+</td> <td>\$50.64</td> </tr> </tbody> </table> <p>HN Female to HN Female</p> <p>Model No: PE9580</p>	PRICE		1-24	\$58.88	25-49	\$55.94	50-99	\$52.99	100+	\$50.64	 <table border="1"> <thead> <tr> <th colspan="2">PRICE</th> </tr> </thead> <tbody> <tr> <td>1-9</td> <td>\$135.66</td> </tr> <tr> <td>10-24</td> <td>\$128.88</td> </tr> <tr> <td>25-49</td> <td>\$122.09</td> </tr> <tr> <td>50+</td> <td>\$116.67</td> </tr> </tbody> </table> <p>HN Female to HN Female Tee</p> <p>Model No: PE9574</p>	PRICE		1-9	\$135.66	10-24	\$128.88	25-49	\$122.09	50+	\$116.67	 <table border="1"> <thead> <tr> <th colspan="2">PRICE</th> </tr> </thead> <tbody> <tr> <td>1-24</td> <td>\$70.29</td> </tr> <tr> <td>25-49</td> <td>\$66.78</td> </tr> <tr> <td>50-99</td> <td>\$63.26</td> </tr> <tr> <td>100+</td> <td>\$60.45</td> </tr> </tbody> </table> <p>HN Female to HN Female Bulkhead-Mounting Hole G03 VSWR 1.3:1 to 2 GHz</p> <p>Model No: PE9193</p>	PRICE		1-24	\$70.29	25-49	\$66.78	50-99	\$63.26	100+	\$60.45
PRICE																																																							
1-9	\$195.25																																																						
10-24	\$185.49																																																						
25-49	\$175.73																																																						
50+	\$167.92																																																						
PRICE																																																							
1-9	\$138.56																																																						
10-24	\$131.63																																																						
25-49	\$124.70																																																						
50+	\$119.16																																																						
PRICE																																																							
1-24	\$58.88																																																						
25-49	\$55.94																																																						
50-99	\$52.99																																																						
100+	\$50.64																																																						
PRICE																																																							
1-9	\$135.66																																																						
10-24	\$128.88																																																						
25-49	\$122.09																																																						
50+	\$116.67																																																						
PRICE																																																							
1-24	\$70.29																																																						
25-49	\$66.78																																																						
50-99	\$63.26																																																						
100+	\$60.45																																																						
2	<p>HN Between Series</p> <p>→</p>		 <table border="1"> <thead> <tr> <th colspan="2">PRICE</th> </tr> </thead> <tbody> <tr> <td>1-24</td> <td>\$95.71</td> </tr> <tr> <td>25-49</td> <td>\$90.92</td> </tr> <tr> <td>50-99</td> <td>\$86.14</td> </tr> <tr> <td>100+</td> <td>\$82.31</td> </tr> </tbody> </table> <p>HN Male to BNC Male</p> <p>Model No: PE9567</p>	PRICE		1-24	\$95.71	25-49	\$90.92	50-99	\$86.14	100+	\$82.31	 <table border="1"> <thead> <tr> <th colspan="2">PRICE</th> </tr> </thead> <tbody> <tr> <td>1-24</td> <td>\$63.56</td> </tr> <tr> <td>25-49</td> <td>\$60.38</td> </tr> <tr> <td>50-99</td> <td>\$57.20</td> </tr> <tr> <td>100+</td> <td>\$54.66</td> </tr> </tbody> </table> <p>HN Male to BNC Female VSWR 1.5:1 to 4 GHz</p> <p>Model No: PE9126</p>	PRICE		1-24	\$63.56	25-49	\$60.38	50-99	\$57.20	100+	\$54.66	 <table border="1"> <thead> <tr> <th colspan="2">PRICE</th> </tr> </thead> <tbody> <tr> <td>1-24</td> <td>\$102.87</td> </tr> <tr> <td>25-49</td> <td>\$97.73</td> </tr> <tr> <td>50-99</td> <td>\$92.58</td> </tr> <tr> <td>100+</td> <td>\$88.47</td> </tr> </tbody> </table> <p>HN Male to C Male Max. Freq. 4 GHz</p> <p>Model No: PE9579</p>	PRICE		1-24	\$102.87	25-49	\$97.73	50-99	\$92.58	100+	\$88.47	 <table border="1"> <thead> <tr> <th colspan="2">PRICE</th> </tr> </thead> <tbody> <tr> <td>1-24</td> <td>\$80.17</td> </tr> <tr> <td>25-49</td> <td>\$76.16</td> </tr> <tr> <td>50-99</td> <td>\$72.15</td> </tr> <tr> <td>100+</td> <td>\$68.95</td> </tr> </tbody> </table> <p>HN Male to C Female</p> <p>Model No: PE9296</p>	PRICE		1-24	\$80.17	25-49	\$76.16	50-99	\$72.15	100+	\$68.95									
PRICE																																																							
1-24	\$95.71																																																						
25-49	\$90.92																																																						
50-99	\$86.14																																																						
100+	\$82.31																																																						
PRICE																																																							
1-24	\$63.56																																																						
25-49	\$60.38																																																						
50-99	\$57.20																																																						
100+	\$54.66																																																						
PRICE																																																							
1-24	\$102.87																																																						
25-49	\$97.73																																																						
50-99	\$92.58																																																						
100+	\$88.47																																																						
PRICE																																																							
1-24	\$80.17																																																						
25-49	\$76.16																																																						
50-99	\$72.15																																																						
100+	\$68.95																																																						
3	 <table border="1"> <thead> <tr> <th colspan="2">PRICE</th> </tr> </thead> <tbody> <tr> <td>1-9</td> <td>\$212.21</td> </tr> <tr> <td>10-24</td> <td>\$201.60</td> </tr> <tr> <td>25-49</td> <td>\$190.99</td> </tr> <tr> <td>50+</td> <td>\$182.50</td> </tr> </tbody> </table> <p>HN Male to GR874 Sexless</p> <p>Model No: PE9386</p>	PRICE		1-9	\$212.21	10-24	\$201.60	25-49	\$190.99	50+	\$182.50	 <table border="1"> <thead> <tr> <th colspan="2">PRICE</th> </tr> </thead> <tbody> <tr> <td>1-9</td> <td>\$139.41</td> </tr> <tr> <td>10-24</td> <td>\$132.44</td> </tr> <tr> <td>25-49</td> <td>\$125.47</td> </tr> <tr> <td>50+</td> <td>\$119.89</td> </tr> </tbody> </table> <p>HN Male to MHV Female</p> <p>Model No: PE9264</p>	PRICE		1-9	\$139.41	10-24	\$132.44	25-49	\$125.47	50+	\$119.89	 <table border="1"> <thead> <tr> <th colspan="2">PRICE</th> </tr> </thead> <tbody> <tr> <td>1-24</td> <td>\$67.18</td> </tr> <tr> <td>25-49</td> <td>\$63.82</td> </tr> <tr> <td>50-99</td> <td>\$60.46</td> </tr> <tr> <td>100+</td> <td>\$57.77</td> </tr> </tbody> </table> <p>HN Female to BNC Male</p> <p>Model No: PE9129</p>	PRICE		1-24	\$67.18	25-49	\$63.82	50-99	\$60.46	100+	\$57.77	 <table border="1"> <thead> <tr> <th colspan="2">PRICE</th> </tr> </thead> <tbody> <tr> <td>1-24</td> <td>\$123.37</td> </tr> <tr> <td>25-49</td> <td>\$117.20</td> </tr> <tr> <td>50-99</td> <td>\$111.03</td> </tr> <tr> <td>100+</td> <td>\$106.10</td> </tr> </tbody> </table> <p>HN Female to C Male</p> <p>Model No: PE9212</p>	PRICE		1-24	\$123.37	25-49	\$117.20	50-99	\$111.03	100+	\$106.10	 <table border="1"> <thead> <tr> <th colspan="2">PRICE</th> </tr> </thead> <tbody> <tr> <td>1-9</td> <td>\$204.24</td> </tr> <tr> <td>10-24</td> <td>\$194.03</td> </tr> <tr> <td>25-49</td> <td>\$183.82</td> </tr> <tr> <td>50+</td> <td>\$175.65</td> </tr> </tbody> </table> <p>HN Female to GR874 Sexless</p> <p>Model No: PE9387</p>	PRICE		1-9	\$204.24	10-24	\$194.03	25-49	\$183.82	50+	\$175.65
PRICE																																																							
1-9	\$212.21																																																						
10-24	\$201.60																																																						
25-49	\$190.99																																																						
50+	\$182.50																																																						
PRICE																																																							
1-9	\$139.41																																																						
10-24	\$132.44																																																						
25-49	\$125.47																																																						
50+	\$119.89																																																						
PRICE																																																							
1-24	\$67.18																																																						
25-49	\$63.82																																																						
50-99	\$60.46																																																						
100+	\$57.77																																																						
PRICE																																																							
1-24	\$123.37																																																						
25-49	\$117.20																																																						
50-99	\$111.03																																																						
100+	\$106.10																																																						
PRICE																																																							
1-9	\$204.24																																																						
10-24	\$194.03																																																						
25-49	\$183.82																																																						
50+	\$175.65																																																						
4	<p>LC In-Series</p> <p>→</p>		 <table border="1"> <thead> <tr> <th colspan="2">PRICE</th> </tr> </thead> <tbody> <tr> <td>1-9</td> <td>\$302.54</td> </tr> <tr> <td>10-24</td> <td>\$287.41</td> </tr> <tr> <td>25-49</td> <td>\$272.29</td> </tr> <tr> <td>50+</td> <td>\$260.18</td> </tr> </tbody> </table> <p>LC Male to LC Male</p> <p>Model No: PE9569</p>	PRICE		1-9	\$302.54	10-24	\$287.41	25-49	\$272.29	50+	\$260.18	 <table border="1"> <thead> <tr> <th colspan="2">PRICE</th> </tr> </thead> <tbody> <tr> <td>1-9</td> <td>\$402.08</td> </tr> <tr> <td>10-24</td> <td>\$381.98</td> </tr> <tr> <td>25-49</td> <td>\$361.87</td> </tr> <tr> <td>50+</td> <td>\$345.79</td> </tr> </tbody> </table> <p>LC Male to LC Female Right Angle</p> <p>Model No: PE9398</p>	PRICE		1-9	\$402.08	10-24	\$381.98	25-49	\$361.87	50+	\$345.79	 <table border="1"> <thead> <tr> <th colspan="2">PRICE</th> </tr> </thead> <tbody> <tr> <td>1-9</td> <td>\$251.02</td> </tr> <tr> <td>10-24</td> <td>\$238.47</td> </tr> <tr> <td>25-49</td> <td>\$225.92</td> </tr> <tr> <td>50+</td> <td>\$215.88</td> </tr> </tbody> </table> <p>LC Female to LC Female</p> <p>Model No: PE9419</p>	PRICE		1-9	\$251.02	10-24	\$238.47	25-49	\$225.92	50+	\$215.88	<p>LC Between Series</p> <p>→</p>																			
PRICE																																																							
1-9	\$302.54																																																						
10-24	\$287.41																																																						
25-49	\$272.29																																																						
50+	\$260.18																																																						
PRICE																																																							
1-9	\$402.08																																																						
10-24	\$381.98																																																						
25-49	\$361.87																																																						
50+	\$345.79																																																						
PRICE																																																							
1-9	\$251.02																																																						
10-24	\$238.47																																																						
25-49	\$225.92																																																						
50+	\$215.88																																																						
5	 <table border="1"> <thead> <tr> <th colspan="2">PRICE</th> </tr> </thead> <tbody> <tr> <td>1-9</td> <td>\$305.24</td> </tr> <tr> <td>10-24</td> <td>\$289.98</td> </tr> <tr> <td>25-49</td> <td>\$274.72</td> </tr> <tr> <td>50+</td> <td>\$262.51</td> </tr> </tbody> </table> <p>LC Male to HN Female</p> <p>Model No: PE9181</p>	PRICE		1-9	\$305.24	10-24	\$289.98	25-49	\$274.72	50+	\$262.51	 <table border="1"> <thead> <tr> <th colspan="2">PRICE</th> </tr> </thead> <tbody> <tr> <td>1-9</td> <td>\$271.99</td> </tr> <tr> <td>10-24</td> <td>\$258.39</td> </tr> <tr> <td>25-49</td> <td>\$244.79</td> </tr> <tr> <td>50+</td> <td>\$233.91</td> </tr> </tbody> </table> <p>LC Female to HN Male</p> <p>Model No: PE9413</p>	PRICE		1-9	\$271.99	10-24	\$258.39	25-49	\$244.79	50+	\$233.91	<p>MCX In-Series</p> <p>→</p>		 <table border="1"> <thead> <tr> <th colspan="2">PRICE</th> </tr> </thead> <tbody> <tr> <td>1-24</td> <td>\$71.18</td> </tr> <tr> <td>25-49</td> <td>\$67.62</td> </tr> <tr> <td>50-99</td> <td>\$64.06</td> </tr> <tr> <td>100+</td> <td>\$61.21</td> </tr> </tbody> </table> <p>MCX Plug to MCX Jack VSWR 1.35:1 to 6 GHz</p> <p>Model No: PE9479</p>	PRICE		1-24	\$71.18	25-49	\$67.62	50-99	\$64.06	100+	\$61.21	 <table border="1"> <thead> <tr> <th colspan="2">PRICE</th> </tr> </thead> <tbody> <tr> <td>1-24</td> <td>\$21.23</td> </tr> <tr> <td>25-49</td> <td>\$20.17</td> </tr> <tr> <td>50-99</td> <td>\$19.11</td> </tr> <tr> <td>100+</td> <td>\$18.26</td> </tr> </tbody> </table> <p>MCX Jack to MCX Jack</p> <p>Model No: PE9524</p>	PRICE		1-24	\$21.23	25-49	\$20.17	50-99	\$19.11	100+	\$18.26									
PRICE																																																							
1-9	\$305.24																																																						
10-24	\$289.98																																																						
25-49	\$274.72																																																						
50+	\$262.51																																																						
PRICE																																																							
1-9	\$271.99																																																						
10-24	\$258.39																																																						
25-49	\$244.79																																																						
50+	\$233.91																																																						
PRICE																																																							
1-24	\$71.18																																																						
25-49	\$67.62																																																						
50-99	\$64.06																																																						
100+	\$61.21																																																						
PRICE																																																							
1-24	\$21.23																																																						
25-49	\$20.17																																																						
50-99	\$19.11																																																						
100+	\$18.26																																																						
6	 <table border="1"> <thead> <tr> <th colspan="2">PRICE</th> </tr> </thead> <tbody> <tr> <td>1-24</td> <td>\$27.27</td> </tr> <tr> <td>25-49</td> <td>\$25.91</td> </tr> <tr> <td>50-99</td> <td>\$24.54</td> </tr> <tr> <td>100+</td> <td>\$23.45</td> </tr> </tbody> </table> <p>MCX Jack to MCX Jack Bulkhead VSWR 1.35:1 to 3 GHz</p> <p>Model No: PE9474</p>	PRICE		1-24	\$27.27	25-49	\$25.91	50-99	\$24.54	100+	\$23.45	<p>MCX Between Series</p> <p>→</p>		 <table border="1"> <thead> <tr> <th colspan="2">PRICE</th> </tr> </thead> <tbody> <tr> <td>1-24</td> <td>\$96.89</td> </tr> <tr> <td>25-49</td> <td>\$92.05</td> </tr> <tr> <td>50-99</td> <td>\$87.20</td> </tr> <tr> <td>100+</td> <td>\$83.33</td> </tr> </tbody> </table> <p>MCX Plug to BNC Male</p> <p>Model No: PE9469</p>	PRICE		1-24	\$96.89	25-49	\$92.05	50-99	\$87.20	100+	\$83.33	 <table border="1"> <thead> <tr> <th colspan="2">PRICE</th> </tr> </thead> <tbody> <tr> <td>1-24</td> <td>\$81.81</td> </tr> <tr> <td>25-49</td> <td>\$77.72</td> </tr> <tr> <td>50-99</td> <td>\$73.63</td> </tr> <tr> <td>100+</td> <td>\$70.36</td> </tr> </tbody> </table> <p>MCX Plug to BNC Female</p> <p>Model No: PE9467</p>	PRICE		1-24	\$81.81	25-49	\$77.72	50-99	\$73.63	100+	\$70.36	 <table border="1"> <thead> <tr> <th colspan="2">PRICE</th> </tr> </thead> <tbody> <tr> <td>1-24</td> <td>\$76.11</td> </tr> <tr> <td>25-49</td> <td>\$72.30</td> </tr> <tr> <td>50-99</td> <td>\$68.50</td> </tr> <tr> <td>100+</td> <td>\$65.45</td> </tr> </tbody> </table> <p>MCX Jack to BNC Male</p> <p>Model No: PE9468</p>	PRICE		1-24	\$76.11	25-49	\$72.30	50-99	\$68.50	100+	\$65.45									
PRICE																																																							
1-24	\$27.27																																																						
25-49	\$25.91																																																						
50-99	\$24.54																																																						
100+	\$23.45																																																						
PRICE																																																							
1-24	\$96.89																																																						
25-49	\$92.05																																																						
50-99	\$87.20																																																						
100+	\$83.33																																																						
PRICE																																																							
1-24	\$81.81																																																						
25-49	\$77.72																																																						
50-99	\$73.63																																																						
100+	\$70.36																																																						
PRICE																																																							
1-24	\$76.11																																																						
25-49	\$72.30																																																						
50-99	\$68.50																																																						
100+	\$65.45																																																						
7	 <table border="1"> <thead> <tr> <th colspan="2">PRICE</th> </tr> </thead> <tbody> <tr> <td>1-24</td> <td>\$97.55</td> </tr> <tr> <td>25-49</td> <td>\$92.67</td> </tr> <tr> <td>50-99</td> <td>\$87.80</td> </tr> <tr> <td>100+</td> <td>\$83.89</td> </tr> </tbody> </table> <p>MCX Jack to BNC Female</p> <p>Model No: PE9466</p>	PRICE		1-24	\$97.55	25-49	\$92.67	50-99	\$87.80	100+	\$83.89	 <table border="1"> <thead> <tr> <th colspan="2">PRICE</th> </tr> </thead> <tbody> <tr> <td>1-24</td> <td>\$97.80</td> </tr> <tr> <td>25-49</td> <td>\$92.91</td> </tr> <tr> <td>50-99</td> <td>\$88.02</td> </tr> <tr> <td>100+</td> <td>\$84.11</td> </tr> </tbody> </table> <p>MCX Jack to BNC Female Bulkhead-Mounting Hole B04</p> <p>Model No: PE9520</p>	PRICE		1-24	\$97.80	25-49	\$92.91	50-99	\$88.02	100+	\$84.11	<p>MHV In-Series</p> <p>→</p>		 <table border="1"> <thead> <tr> <th colspan="2">PRICE</th> </tr> </thead> <tbody> <tr> <td>1-24</td> <td>\$44.40</td> </tr> <tr> <td>25-49</td> <td>\$42.18</td> </tr> <tr> <td>50-99</td> <td>\$39.96</td> </tr> <tr> <td>100+</td> <td>\$38.18</td> </tr> </tbody> </table> <p>MHV Male to BNC Female VSWR 1.3:1 to 300 MHz</p> <p>Model No: PE9297</p>	PRICE		1-24	\$44.40	25-49	\$42.18	50-99	\$39.96	100+	\$38.18	 <table border="1"> <thead> <tr> <th colspan="2">PRICE</th> </tr> </thead> <tbody> <tr> <td>1-24</td> <td>\$59.73</td> </tr> <tr> <td>25-49</td> <td>\$56.74</td> </tr> <tr> <td>50-99</td> <td>\$53.76</td> </tr> <tr> <td>100+</td> <td>\$51.37</td> </tr> </tbody> </table> <p>MHV Male to MHV Female Right Angle Max. Freq. 50 MHz</p> <p>Model No: PE9266</p>	PRICE		1-24	\$59.73	25-49	\$56.74	50-99	\$53.76	100+	\$51.37									
PRICE																																																							
1-24	\$97.55																																																						
25-49	\$92.67																																																						
50-99	\$87.80																																																						
100+	\$83.89																																																						
PRICE																																																							
1-24	\$97.80																																																						
25-49	\$92.91																																																						
50-99	\$88.02																																																						
100+	\$84.11																																																						
PRICE																																																							
1-24	\$44.40																																																						
25-49	\$42.18																																																						
50-99	\$39.96																																																						
100+	\$38.18																																																						
PRICE																																																							
1-24	\$59.73																																																						
25-49	\$56.74																																																						
50-99	\$53.76																																																						
100+	\$51.37																																																						

ADAPTERS

See Adapter Locator on Pages 8-13

See Page 369 for Mounting Holes

Adapters

See Our Website For Current Pricing & Real-Time Stock Availability!

	A	B	C	D	E																																																		
1	 <table border="1"> <thead> <tr><th colspan="2">PRICE</th></tr> </thead> <tbody> <tr><td>1-24</td><td>\$54.83</td></tr> <tr><td>25-49</td><td>\$52.09</td></tr> <tr><td>50-99</td><td>\$49.35</td></tr> <tr><td>100+</td><td>\$47.15</td></tr> </tbody> </table> <p>MHV Female to MHV Male Tee Max. Freq. 50 MHz</p> <p>Model No: PE9211</p>	PRICE		1-24	\$54.83	25-49	\$52.09	50-99	\$49.35	100+	\$47.15	 <table border="1"> <thead> <tr><th colspan="2">PRICE</th></tr> </thead> <tbody> <tr><td>1-24</td><td>\$36.26</td></tr> <tr><td>25-49</td><td>\$34.45</td></tr> <tr><td>50-99</td><td>\$32.63</td></tr> <tr><td>100+</td><td>\$31.18</td></tr> </tbody> </table> <p>MHV Female to MHV Female VSWR 1.3:1 to 300 MHz</p> <p>Model No: PE9267</p>	PRICE		1-24	\$36.26	25-49	\$34.45	50-99	\$32.63	100+	\$31.18	 <table border="1"> <thead> <tr><th colspan="2">PRICE</th></tr> </thead> <tbody> <tr><td>1-24</td><td>\$61.77</td></tr> <tr><td>25-49</td><td>\$58.68</td></tr> <tr><td>50-99</td><td>\$55.59</td></tr> <tr><td>100+</td><td>\$53.12</td></tr> </tbody> </table> <p>MHV Female to MHV Female Bulkhead</p> <p>Model No: PE9268</p>	PRICE		1-24	\$61.77	25-49	\$58.68	50-99	\$55.59	100+	\$53.12	<p style="text-align: center;">MHV Between Series</p> <p style="text-align: center;">→</p>	 <table border="1"> <thead> <tr><th colspan="2">PRICE</th></tr> </thead> <tbody> <tr><td>1-24</td><td>\$103.78</td></tr> <tr><td>25-49</td><td>\$98.59</td></tr> <tr><td>50-99</td><td>\$93.40</td></tr> <tr><td>100+</td><td>\$89.25</td></tr> </tbody> </table> <p>MHV Male to SHV Plug</p> <p>Model No: PE9340</p>	PRICE		1-24	\$103.78	25-49	\$98.59	50-99	\$93.40	100+	\$89.25										
	PRICE																																																						
1-24	\$54.83																																																						
25-49	\$52.09																																																						
50-99	\$49.35																																																						
100+	\$47.15																																																						
PRICE																																																							
1-24	\$36.26																																																						
25-49	\$34.45																																																						
50-99	\$32.63																																																						
100+	\$31.18																																																						
PRICE																																																							
1-24	\$61.77																																																						
25-49	\$58.68																																																						
50-99	\$55.59																																																						
100+	\$53.12																																																						
PRICE																																																							
1-24	\$103.78																																																						
25-49	\$98.59																																																						
50-99	\$93.40																																																						
100+	\$89.25																																																						
2	 <table border="1"> <thead> <tr><th colspan="2">PRICE</th></tr> </thead> <tbody> <tr><td>1-9</td><td>\$125.48</td></tr> <tr><td>10-24</td><td>\$119.21</td></tr> <tr><td>25-49</td><td>\$112.93</td></tr> <tr><td>50+</td><td>\$107.91</td></tr> </tbody> </table> <p>MHV Male to SHV Jack</p> <p>Model No: PE9335</p>	PRICE		1-9	\$125.48	10-24	\$119.21	25-49	\$112.93	50+	\$107.91	 <table border="1"> <thead> <tr><th colspan="2">PRICE</th></tr> </thead> <tbody> <tr><td>1-9</td><td>\$114.61</td></tr> <tr><td>10-24</td><td>\$108.88</td></tr> <tr><td>25-49</td><td>\$103.15</td></tr> <tr><td>50+</td><td>\$98.56</td></tr> </tbody> </table> <p>MHV Female to SHV Plug</p> <p>Model No: PE9265</p>	PRICE		1-9	\$114.61	10-24	\$108.88	25-49	\$103.15	50+	\$98.56	 <table border="1"> <thead> <tr><th colspan="2">PRICE</th></tr> </thead> <tbody> <tr><td>1-24</td><td>\$67.60</td></tr> <tr><td>25-49</td><td>\$64.22</td></tr> <tr><td>50-99</td><td>\$60.84</td></tr> <tr><td>100+</td><td>\$58.14</td></tr> </tbody> </table> <p>MHV Female to SHV Jack</p> <p>Model No: PE9339</p>	PRICE		1-24	\$67.60	25-49	\$64.22	50-99	\$60.84	100+	\$58.14	<p style="text-align: center;">Mini SMP In-Series</p> <p style="text-align: center;">→</p>	 <table border="1"> <thead> <tr><th colspan="2">PRICE</th></tr> </thead> <tbody> <tr><td>1-24</td><td>\$50.20</td></tr> <tr><td>25-49</td><td>\$47.69</td></tr> <tr><td>50-99</td><td>\$45.18</td></tr> <tr><td>100+</td><td>\$43.17</td></tr> </tbody> </table> <p>Mini SMP Female to Mini SMP Female Max. Freq. 65 GHz</p> <p>Model No: PE9780</p>	PRICE		1-24	\$50.20	25-49	\$47.69	50-99	\$45.18	100+	\$43.17										
	PRICE																																																						
1-9	\$125.48																																																						
10-24	\$119.21																																																						
25-49	\$112.93																																																						
50+	\$107.91																																																						
PRICE																																																							
1-9	\$114.61																																																						
10-24	\$108.88																																																						
25-49	\$103.15																																																						
50+	\$98.56																																																						
PRICE																																																							
1-24	\$67.60																																																						
25-49	\$64.22																																																						
50-99	\$60.84																																																						
100+	\$58.14																																																						
PRICE																																																							
1-24	\$50.20																																																						
25-49	\$47.69																																																						
50-99	\$45.18																																																						
100+	\$43.17																																																						
3	 <table border="1"> <thead> <tr><th colspan="2">PRICE</th></tr> </thead> <tbody> <tr><td>1-24</td><td>\$28.42</td></tr> <tr><td>25-49</td><td>\$27.00</td></tr> <tr><td>50-99</td><td>\$25.58</td></tr> <tr><td>100+</td><td>\$24.44</td></tr> </tbody> </table> <p>Mini SMP Female to Mini SMP Female VSWR 1.2:1 to 26.5 GHz</p> <p>Model No: PE91069</p>	PRICE		1-24	\$28.42	25-49	\$27.00	50-99	\$25.58	100+	\$24.44	<p style="text-align: center;">Mini UHF In-Series</p> <p style="text-align: center;">→</p>	 <table border="1"> <thead> <tr><th colspan="2">PRICE</th></tr> </thead> <tbody> <tr><td>1-24</td><td>\$16.58</td></tr> <tr><td>25-49</td><td>\$15.75</td></tr> <tr><td>50-99</td><td>\$14.92</td></tr> <tr><td>100+</td><td>\$14.26</td></tr> </tbody> </table> <p>Mini UHF Male to Mini UHF Female Right Angle</p> <p>Model No: PE9347</p>	PRICE		1-24	\$16.58	25-49	\$15.75	50-99	\$14.92	100+	\$14.26	 <table border="1"> <thead> <tr><th colspan="2">PRICE</th></tr> </thead> <tbody> <tr><td>1-24</td><td>\$9.84</td></tr> <tr><td>25-49</td><td>\$9.35</td></tr> <tr><td>50-99</td><td>\$8.86</td></tr> <tr><td>100+</td><td>\$8.46</td></tr> </tbody> </table> <p>Mini UHF Female to Mini UHF Male Tee</p> <p>Model No: PE9065</p>	PRICE		1-24	\$9.84	25-49	\$9.35	50-99	\$8.86	100+	\$8.46	 <table border="1"> <thead> <tr><th colspan="2">PRICE</th></tr> </thead> <tbody> <tr><td>1-24</td><td>\$18.56</td></tr> <tr><td>25-49</td><td>\$17.63</td></tr> <tr><td>50-99</td><td>\$16.70</td></tr> <tr><td>100+</td><td>\$15.96</td></tr> </tbody> </table> <p>Mini UHF Female to Mini UHF Female</p> <p>Model No: PE9343</p>	PRICE		1-24	\$18.56	25-49	\$17.63	50-99	\$16.70	100+	\$15.96										
	PRICE																																																						
1-24	\$28.42																																																						
25-49	\$27.00																																																						
50-99	\$25.58																																																						
100+	\$24.44																																																						
PRICE																																																							
1-24	\$16.58																																																						
25-49	\$15.75																																																						
50-99	\$14.92																																																						
100+	\$14.26																																																						
PRICE																																																							
1-24	\$9.84																																																						
25-49	\$9.35																																																						
50-99	\$8.86																																																						
100+	\$8.46																																																						
PRICE																																																							
1-24	\$18.56																																																						
25-49	\$17.63																																																						
50-99	\$16.70																																																						
100+	\$15.96																																																						
4	 <table border="1"> <thead> <tr><th colspan="2">PRICE</th></tr> </thead> <tbody> <tr><td>1-24</td><td>\$17.35</td></tr> <tr><td>25-49</td><td>\$16.48</td></tr> <tr><td>50-99</td><td>\$15.62</td></tr> <tr><td>100+</td><td>\$14.92</td></tr> </tbody> </table> <p>Mini UHF Female to Mini UHF Female Tee</p> <p>Model No: PE9066</p>	PRICE		1-24	\$17.35	25-49	\$16.48	50-99	\$15.62	100+	\$14.92	<p style="text-align: center;">Mini UHF Between Series</p> <p style="text-align: center;">→</p>	 <table border="1"> <thead> <tr><th colspan="2">PRICE</th></tr> </thead> <tbody> <tr><td>1-24</td><td>\$17.69</td></tr> <tr><td>25-49</td><td>\$16.81</td></tr> <tr><td>50-99</td><td>\$15.92</td></tr> <tr><td>100+</td><td>\$15.21</td></tr> </tbody> </table> <p>Mini UHF Male to BNC Female</p> <p>Model No: PE9342</p>	PRICE		1-24	\$17.69	25-49	\$16.81	50-99	\$15.92	100+	\$15.21	 <table border="1"> <thead> <tr><th colspan="2">PRICE</th></tr> </thead> <tbody> <tr><td>1-24</td><td>\$16.99</td></tr> <tr><td>25-49</td><td>\$16.14</td></tr> <tr><td>50-99</td><td>\$15.29</td></tr> <tr><td>100+</td><td>\$14.61</td></tr> </tbody> </table> <p>Mini UHF Male to FME Plug</p> <p>Model No: PE9705</p>	PRICE		1-24	\$16.99	25-49	\$16.14	50-99	\$15.29	100+	\$14.61	 <table border="1"> <thead> <tr><th colspan="2">PRICE</th></tr> </thead> <tbody> <tr><td>1-24</td><td>\$16.23</td></tr> <tr><td>25-49</td><td>\$15.42</td></tr> <tr><td>50-99</td><td>\$14.61</td></tr> <tr><td>100+</td><td>\$13.96</td></tr> </tbody> </table> <p>Mini UHF Male to FME Plug Right Angle</p> <p>Model No: PE9706</p>	PRICE		1-24	\$16.23	25-49	\$15.42	50-99	\$14.61	100+	\$13.96										
	PRICE																																																						
1-24	\$17.35																																																						
25-49	\$16.48																																																						
50-99	\$15.62																																																						
100+	\$14.92																																																						
PRICE																																																							
1-24	\$17.69																																																						
25-49	\$16.81																																																						
50-99	\$15.92																																																						
100+	\$15.21																																																						
PRICE																																																							
1-24	\$16.99																																																						
25-49	\$16.14																																																						
50-99	\$15.29																																																						
100+	\$14.61																																																						
PRICE																																																							
1-24	\$16.23																																																						
25-49	\$15.42																																																						
50-99	\$14.61																																																						
100+	\$13.96																																																						
5	 <table border="1"> <thead> <tr><th colspan="2">PRICE</th></tr> </thead> <tbody> <tr><td>1-24</td><td>\$14.03</td></tr> <tr><td>25-49</td><td>\$13.33</td></tr> <tr><td>50-99</td><td>\$12.63</td></tr> <tr><td>100+</td><td>\$12.07</td></tr> </tbody> </table> <p>Mini UHF Male to FME Jack</p> <p>Model No: PE9709</p>	PRICE		1-24	\$14.03	25-49	\$13.33	50-99	\$12.63	100+	\$12.07	 <table border="1"> <thead> <tr><th colspan="2">PRICE</th></tr> </thead> <tbody> <tr><td>1-24</td><td>\$19.18</td></tr> <tr><td>25-49</td><td>\$18.22</td></tr> <tr><td>50-99</td><td>\$17.26</td></tr> <tr><td>100+</td><td>\$16.49</td></tr> </tbody> </table> <p>Mini UHF Female to BNC Male</p> <p>Model No: PE9341</p>	PRICE		1-24	\$19.18	25-49	\$18.22	50-99	\$17.26	100+	\$16.49	 <table border="1"> <thead> <tr><th colspan="2">PRICE</th></tr> </thead> <tbody> <tr><td>1-24</td><td>\$14.86</td></tr> <tr><td>25-49</td><td>\$14.12</td></tr> <tr><td>50-99</td><td>\$13.37</td></tr> <tr><td>100+</td><td>\$12.78</td></tr> </tbody> </table> <p>Mini UHF Female to FME Jack</p> <p>Model No: PE9710</p>	PRICE		1-24	\$14.86	25-49	\$14.12	50-99	\$13.37	100+	\$12.78	<p style="text-align: center;">MMCX In-Series</p> <p style="text-align: center;">→</p>	 <table border="1"> <thead> <tr><th colspan="2">PRICE</th></tr> </thead> <tbody> <tr><td>1-24</td><td>\$84.62</td></tr> <tr><td>25-49</td><td>\$80.39</td></tr> <tr><td>50-99</td><td>\$76.16</td></tr> <tr><td>100+</td><td>\$72.77</td></tr> </tbody> </table> <p>MMCX Plug to MMCX Jack</p> <p>Model No: PE9480</p>	PRICE		1-24	\$84.62	25-49	\$80.39	50-99	\$76.16	100+	\$72.77										
	PRICE																																																						
1-24	\$14.03																																																						
25-49	\$13.33																																																						
50-99	\$12.63																																																						
100+	\$12.07																																																						
PRICE																																																							
1-24	\$19.18																																																						
25-49	\$18.22																																																						
50-99	\$17.26																																																						
100+	\$16.49																																																						
PRICE																																																							
1-24	\$14.86																																																						
25-49	\$14.12																																																						
50-99	\$13.37																																																						
100+	\$12.78																																																						
PRICE																																																							
1-24	\$84.62																																																						
25-49	\$80.39																																																						
50-99	\$76.16																																																						
100+	\$72.77																																																						
6	 <table border="1"> <thead> <tr><th colspan="2">PRICE</th></tr> </thead> <tbody> <tr><td>1-24</td><td>\$73.01</td></tr> <tr><td>25-49</td><td>\$69.36</td></tr> <tr><td>50-99</td><td>\$65.71</td></tr> <tr><td>100+</td><td>\$62.79</td></tr> </tbody> </table> <p>MMCX Jack to MMCX Jack</p> <p>Model No: PE9523</p>	PRICE		1-24	\$73.01	25-49	\$69.36	50-99	\$65.71	100+	\$62.79	 <table border="1"> <thead> <tr><th colspan="2">PRICE</th></tr> </thead> <tbody> <tr><td>1-24</td><td>\$65.41</td></tr> <tr><td>25-49</td><td>\$62.14</td></tr> <tr><td>50-99</td><td>\$58.87</td></tr> <tr><td>100+</td><td>\$56.25</td></tr> </tbody> </table> <p>MMCX Jack to MMCX Jack Bulkhead-Mounting Hole B01</p> <p>Model No: PE9522</p>	PRICE		1-24	\$65.41	25-49	\$62.14	50-99	\$58.87	100+	\$56.25	<p style="text-align: center;">MMCX Between Series</p> <p style="text-align: center;">→</p>	 <table border="1"> <thead> <tr><th colspan="2">PRICE</th></tr> </thead> <tbody> <tr><td>1-9</td><td>\$112.21</td></tr> <tr><td>10-24</td><td>\$106.60</td></tr> <tr><td>25-49</td><td>\$100.99</td></tr> <tr><td>50+</td><td>\$96.50</td></tr> </tbody> </table> <p>MMCX Plug to BNC Male</p> <p>Model No: PE9517</p>	PRICE		1-9	\$112.21	10-24	\$106.60	25-49	\$100.99	50+	\$96.50	 <table border="1"> <thead> <tr><th colspan="2">PRICE</th></tr> </thead> <tbody> <tr><td>1-9</td><td>\$123.53</td></tr> <tr><td>10-24</td><td>\$117.35</td></tr> <tr><td>25-49</td><td>\$111.18</td></tr> <tr><td>50+</td><td>\$106.24</td></tr> </tbody> </table> <p>MMCX Plug to BNC Female</p> <p>Model No: PE9519</p>	PRICE		1-9	\$123.53	10-24	\$117.35	25-49	\$111.18	50+	\$106.24										
	PRICE																																																						
1-24	\$73.01																																																						
25-49	\$69.36																																																						
50-99	\$65.71																																																						
100+	\$62.79																																																						
PRICE																																																							
1-24	\$65.41																																																						
25-49	\$62.14																																																						
50-99	\$58.87																																																						
100+	\$56.25																																																						
PRICE																																																							
1-9	\$112.21																																																						
10-24	\$106.60																																																						
25-49	\$100.99																																																						
50+	\$96.50																																																						
PRICE																																																							
1-9	\$123.53																																																						
10-24	\$117.35																																																						
25-49	\$111.18																																																						
50+	\$106.24																																																						
7	 <table border="1"> <thead> <tr><th colspan="2">PRICE</th></tr> </thead> <tbody> <tr><td>1-24</td><td>\$96.42</td></tr> <tr><td>25-49</td><td>\$91.60</td></tr> <tr><td>50-99</td><td>\$86.78</td></tr> <tr><td>100+</td><td>\$82.92</td></tr> </tbody> </table> <p>MMCX Plug to MCX Plug</p> <p>Model No: PE9527</p>	PRICE		1-24	\$96.42	25-49	\$91.60	50-99	\$86.78	100+	\$82.92	 <table border="1"> <thead> <tr><th colspan="2">PRICE</th></tr> </thead> <tbody> <tr><td>1-24</td><td>\$116.30</td></tr> <tr><td>25-49</td><td>\$110.49</td></tr> <tr><td>50-99</td><td>\$104.67</td></tr> <tr><td>100+</td><td>\$100.02</td></tr> </tbody> </table> <p>MMCX Plug to MCX Jack</p> <p>Model No: PE9525</p>	PRICE		1-24	\$116.30	25-49	\$110.49	50-99	\$104.67	100+	\$100.02	 <table border="1"> <thead> <tr><th colspan="2">PRICE</th></tr> </thead> <tbody> <tr><td>1-24</td><td>\$89.43</td></tr> <tr><td>25-49</td><td>\$84.96</td></tr> <tr><td>50-99</td><td>\$80.49</td></tr> <tr><td>100+</td><td>\$76.91</td></tr> </tbody> </table> <p>MMCX Jack to BNC Male</p> <p>Model No: PE9518</p>	PRICE		1-24	\$89.43	25-49	\$84.96	50-99	\$80.49	100+	\$76.91	 <table border="1"> <thead> <tr><th colspan="2">PRICE</th></tr> </thead> <tbody> <tr><td>1-24</td><td>\$94.92</td></tr> <tr><td>25-49</td><td>\$90.17</td></tr> <tr><td>50-99</td><td>\$85.43</td></tr> <tr><td>100+</td><td>\$81.63</td></tr> </tbody> </table> <p>MMCX Jack to BNC Female</p> <p>Model No: PE9516</p>	PRICE		1-24	\$94.92	25-49	\$90.17	50-99	\$85.43	100+	\$81.63	 <table border="1"> <thead> <tr><th colspan="2">PRICE</th></tr> </thead> <tbody> <tr><td>1-24</td><td>\$115.70</td></tr> <tr><td>25-49</td><td>\$109.92</td></tr> <tr><td>50-99</td><td>\$104.13</td></tr> <tr><td>100+</td><td>\$99.50</td></tr> </tbody> </table> <p>MMCX Jack to MCX Plug</p> <p>Model No: PE9528</p>	PRICE		1-24	\$115.70	25-49	\$109.92	50-99	\$104.13	100+	\$99.50
	PRICE																																																						
1-24	\$96.42																																																						
25-49	\$91.60																																																						
50-99	\$86.78																																																						
100+	\$82.92																																																						
PRICE																																																							
1-24	\$116.30																																																						
25-49	\$110.49																																																						
50-99	\$104.67																																																						
100+	\$100.02																																																						
PRICE																																																							
1-24	\$89.43																																																						
25-49	\$84.96																																																						
50-99	\$80.49																																																						
100+	\$76.91																																																						
PRICE																																																							
1-24	\$94.92																																																						
25-49	\$90.17																																																						
50-99	\$85.43																																																						
100+	\$81.63																																																						
PRICE																																																							
1-24	\$115.70																																																						
25-49	\$109.92																																																						
50-99	\$104.13																																																						
100+	\$99.50																																																						

ADAPTERS

See Adapter Locator on Pages 8-13

See Page 369 for Mounting Holes

	A	B	C	D	E																																																		
1	 <table border="1"> <thead> <tr> <th colspan="2">PRICE</th> </tr> </thead> <tbody> <tr> <td>1-24</td> <td>\$106.72</td> </tr> <tr> <td>25-49</td> <td>\$101.38</td> </tr> <tr> <td>50-99</td> <td>\$96.05</td> </tr> <tr> <td>100+</td> <td>\$91.78</td> </tr> </tbody> </table> <p>MMCX Jack to MCX Jack</p> <p>Model No: PE9526</p>	PRICE		1-24	\$106.72	25-49	\$101.38	50-99	\$96.05	100+	\$91.78	<p>MMBX In-Series</p> <p>→</p>	 <table border="1"> <thead> <tr> <th colspan="2">PRICE</th> </tr> </thead> <tbody> <tr> <td>1-24</td> <td>\$11.48</td> </tr> <tr> <td>25-49</td> <td>\$10.91</td> </tr> <tr> <td>50-99</td> <td>\$10.33</td> </tr> <tr> <td>100+</td> <td>\$9.87</td> </tr> </tbody> </table> <p>Slide-On MMBX Plug to Snap-On MMBX Plug</p> <p>VSWR 1.08:1 to 12.4 GHz</p> <p>Model No: PE91370</p>	PRICE		1-24	\$11.48	25-49	\$10.91	50-99	\$10.33	100+	\$9.87	 <table border="1"> <thead> <tr> <th colspan="2">PRICE</th> </tr> </thead> <tbody> <tr> <td>1-24</td> <td>\$13.26</td> </tr> <tr> <td>25-49</td> <td>\$12.60</td> </tr> <tr> <td>50-99</td> <td>\$11.93</td> </tr> <tr> <td>100+</td> <td>\$11.40</td> </tr> </tbody> </table> <p>Slide-On MMBX Plug to Snap-On MMBX Plug</p> <p>VSWR 1.08:1 to 12.4 GHz</p> <p>Model No: PE91373</p>	PRICE		1-24	\$13.26	25-49	\$12.60	50-99	\$11.93	100+	\$11.40	 <table border="1"> <thead> <tr> <th colspan="2">PRICE</th> </tr> </thead> <tbody> <tr> <td>1-24</td> <td>\$14.38</td> </tr> <tr> <td>25-49</td> <td>\$13.66</td> </tr> <tr> <td>50-99</td> <td>\$12.94</td> </tr> <tr> <td>100+</td> <td>\$12.37</td> </tr> </tbody> </table> <p>Slide-On MMBX Plug to Slide-On MMBX Plug</p> <p>VSWR 1.15:1 to 12.4 GHz</p> <p>Model No: PE91371</p>	PRICE		1-24	\$14.38	25-49	\$13.66	50-99	\$12.94	100+	\$12.37										
	PRICE																																																						
1-24	\$106.72																																																						
25-49	\$101.38																																																						
50-99	\$96.05																																																						
100+	\$91.78																																																						
PRICE																																																							
1-24	\$11.48																																																						
25-49	\$10.91																																																						
50-99	\$10.33																																																						
100+	\$9.87																																																						
PRICE																																																							
1-24	\$13.26																																																						
25-49	\$12.60																																																						
50-99	\$11.93																																																						
100+	\$11.40																																																						
PRICE																																																							
1-24	\$14.38																																																						
25-49	\$13.66																																																						
50-99	\$12.94																																																						
100+	\$12.37																																																						
2	 <table border="1"> <thead> <tr> <th colspan="2">PRICE</th> </tr> </thead> <tbody> <tr> <td>1-24</td> <td>\$18.44</td> </tr> <tr> <td>25-49</td> <td>\$17.52</td> </tr> <tr> <td>50-99</td> <td>\$16.60</td> </tr> <tr> <td>100+</td> <td>\$15.86</td> </tr> </tbody> </table> <p>Snap-On MMBX Plug to Slide-On MMBX Plug</p> <p>VSWR 1.25:1 to 12.4 GHz</p> <p>Model No: PE91372</p>	PRICE		1-24	\$18.44	25-49	\$17.52	50-99	\$16.60	100+	\$15.86	<p>N In-Series</p> <p>→</p>	 <table border="1"> <thead> <tr> <th colspan="2">PRICE</th> </tr> </thead> <tbody> <tr> <td>1-24</td> <td>\$58.19</td> </tr> <tr> <td>25-49</td> <td>\$55.28</td> </tr> <tr> <td>50-99</td> <td>\$52.37</td> </tr> <tr> <td>100+</td> <td>\$50.04</td> </tr> </tbody> </table> <p>N Male to N Male</p> <p>VSWR 1.2:1 to 6 GHz</p> <p>Model No: PE91198</p>	PRICE		1-24	\$58.19	25-49	\$55.28	50-99	\$52.37	100+	\$50.04	 <table border="1"> <thead> <tr> <th colspan="2">PRICE</th> </tr> </thead> <tbody> <tr> <td>1-24</td> <td>\$43.28</td> </tr> <tr> <td>25-49</td> <td>\$41.12</td> </tr> <tr> <td>50-99</td> <td>\$38.95</td> </tr> <tr> <td>100+</td> <td>\$37.22</td> </tr> </tbody> </table> <p>N Male to N Male</p> <p>VSWR 1.3:1 to 6 GHz</p> <p>Model No: PE91235</p>	PRICE		1-24	\$43.28	25-49	\$41.12	50-99	\$38.95	100+	\$37.22	 <table border="1"> <thead> <tr> <th colspan="2">PRICE</th> </tr> </thead> <tbody> <tr> <td>1-24</td> <td>\$20.14</td> </tr> <tr> <td>25-49</td> <td>\$19.13</td> </tr> <tr> <td>50-99</td> <td>\$18.13</td> </tr> <tr> <td>100+</td> <td>\$17.32</td> </tr> </tbody> </table> <p>N Male to N Male</p> <p>VSWR 1.3:1 to 6 GHz</p> <p>Model No: PE9007</p>	PRICE		1-24	\$20.14	25-49	\$19.13	50-99	\$18.13	100+	\$17.32										
	PRICE																																																						
1-24	\$18.44																																																						
25-49	\$17.52																																																						
50-99	\$16.60																																																						
100+	\$15.86																																																						
PRICE																																																							
1-24	\$58.19																																																						
25-49	\$55.28																																																						
50-99	\$52.37																																																						
100+	\$50.04																																																						
PRICE																																																							
1-24	\$43.28																																																						
25-49	\$41.12																																																						
50-99	\$38.95																																																						
100+	\$37.22																																																						
PRICE																																																							
1-24	\$20.14																																																						
25-49	\$19.13																																																						
50-99	\$18.13																																																						
100+	\$17.32																																																						
3	 <table border="1"> <thead> <tr> <th colspan="2">PRICE</th> </tr> </thead> <tbody> <tr> <td>1-24</td> <td>\$94.34</td> </tr> <tr> <td>25-49</td> <td>\$89.62</td> </tr> <tr> <td>50-99</td> <td>\$84.91</td> </tr> <tr> <td>100+</td> <td>\$81.13</td> </tr> </tbody> </table> <p>Low PIM</p> <p>N Male to N Male</p> <p>Max. Freq. 12.4 GHz</p> <p>Model No: PE91034</p>	PRICE		1-24	\$94.34	25-49	\$89.62	50-99	\$84.91	100+	\$81.13	 <table border="1"> <thead> <tr> <th colspan="2">PRICE</th> </tr> </thead> <tbody> <tr> <td>1-24</td> <td>\$39.91</td> </tr> <tr> <td>25-49</td> <td>\$37.91</td> </tr> <tr> <td>50-99</td> <td>\$35.92</td> </tr> <tr> <td>100+</td> <td>\$34.32</td> </tr> </tbody> </table> <p>N Male to N Male Right Angle</p> <p>VSWR 1.5:1 to 11 GHz</p> <p>Model No: PE9198</p>	PRICE		1-24	\$39.91	25-49	\$37.91	50-99	\$35.92	100+	\$34.32	 <table border="1"> <thead> <tr> <th colspan="2">PRICE</th> </tr> </thead> <tbody> <tr> <td>1-24</td> <td>\$94.68</td> </tr> <tr> <td>25-49</td> <td>\$89.95</td> </tr> <tr> <td>50-99</td> <td>\$85.21</td> </tr> <tr> <td>100+</td> <td>\$81.42</td> </tr> </tbody> </table> <p>N Male to N Male Tee</p> <p>Model No: PE9390</p>	PRICE		1-24	\$94.68	25-49	\$89.95	50-99	\$85.21	100+	\$81.42	 <table border="1"> <thead> <tr> <th colspan="2">PRICE</th> </tr> </thead> <tbody> <tr> <td>1-24</td> <td>\$58.19</td> </tr> <tr> <td>25-49</td> <td>\$55.28</td> </tr> <tr> <td>50-99</td> <td>\$52.37</td> </tr> <tr> <td>100+</td> <td>\$50.04</td> </tr> </tbody> </table> <p>N Male to N Female</p> <p>VSWR 1.2:1 to 6 GHz</p> <p>Model No: PE91199</p>	PRICE		1-24	\$58.19	25-49	\$55.28	50-99	\$52.37	100+	\$50.04	 <table border="1"> <thead> <tr> <th colspan="2">PRICE</th> </tr> </thead> <tbody> <tr> <td>1-24</td> <td>\$41.30</td> </tr> <tr> <td>25-49</td> <td>\$39.24</td> </tr> <tr> <td>50-99</td> <td>\$37.17</td> </tr> <tr> <td>100+</td> <td>\$35.52</td> </tr> </tbody> </table> <p>N Male to N Female</p> <p>VSWR 1.3:1 to 6 GHz</p> <p>Model No: PE91236</p>	PRICE		1-24	\$41.30	25-49	\$39.24	50-99	\$37.17	100+	\$35.52
	PRICE																																																						
1-24	\$94.34																																																						
25-49	\$89.62																																																						
50-99	\$84.91																																																						
100+	\$81.13																																																						
PRICE																																																							
1-24	\$39.91																																																						
25-49	\$37.91																																																						
50-99	\$35.92																																																						
100+	\$34.32																																																						
PRICE																																																							
1-24	\$94.68																																																						
25-49	\$89.95																																																						
50-99	\$85.21																																																						
100+	\$81.42																																																						
PRICE																																																							
1-24	\$58.19																																																						
25-49	\$55.28																																																						
50-99	\$52.37																																																						
100+	\$50.04																																																						
PRICE																																																							
1-24	\$41.30																																																						
25-49	\$39.24																																																						
50-99	\$37.17																																																						
100+	\$35.52																																																						
4	 <table border="1"> <thead> <tr> <th colspan="2">PRICE</th> </tr> </thead> <tbody> <tr> <td>1-24</td> <td>\$98.25</td> </tr> <tr> <td>25-49</td> <td>\$93.34</td> </tr> <tr> <td>50-99</td> <td>\$88.43</td> </tr> <tr> <td>100+</td> <td>\$84.50</td> </tr> </tbody> </table> <p>Low PIM</p> <p>N Male to N Female</p> <p>Max. Freq. 12.4 GHz</p> <p>Model No: PE91040</p>	PRICE		1-24	\$98.25	25-49	\$93.34	50-99	\$88.43	100+	\$84.50	 <table border="1"> <thead> <tr> <th colspan="2">PRICE</th> </tr> </thead> <tbody> <tr> <td>1-24</td> <td>\$30.92</td> </tr> <tr> <td>25-49</td> <td>\$29.37</td> </tr> <tr> <td>50-99</td> <td>\$27.83</td> </tr> <tr> <td>100+</td> <td>\$26.59</td> </tr> </tbody> </table> <p>Push-On N Male to N Female</p> <p>VSWR 1.22:1 to 18 GHz</p> <p>Model No: PE91114</p>	PRICE		1-24	\$30.92	25-49	\$29.37	50-99	\$27.83	100+	\$26.59	 <table border="1"> <thead> <tr> <th colspan="2">PRICE</th> </tr> </thead> <tbody> <tr> <td>1-24</td> <td>\$30.80</td> </tr> <tr> <td>25-49</td> <td>\$29.26</td> </tr> <tr> <td>50-99</td> <td>\$27.72</td> </tr> <tr> <td>100+</td> <td>\$26.49</td> </tr> </tbody> </table> <p>N Male to N Female</p> <p>VSWR 1.3:1 to 11 GHz</p> <p>Model No: PE9311</p>	PRICE		1-24	\$30.80	25-49	\$29.26	50-99	\$27.72	100+	\$26.49	 <table border="1"> <thead> <tr> <th colspan="2">PRICE</th> </tr> </thead> <tbody> <tr> <td>1-24</td> <td>\$55.27</td> </tr> <tr> <td>25-49</td> <td>\$52.51</td> </tr> <tr> <td>50-99</td> <td>\$49.74</td> </tr> <tr> <td>100+</td> <td>\$47.53</td> </tr> </tbody> </table> <p>N Male to 75 Ohm N Female</p> <p>Model No: PE9349</p>	PRICE		1-24	\$55.27	25-49	\$52.51	50-99	\$49.74	100+	\$47.53	 <table border="1"> <thead> <tr> <th colspan="2">PRICE</th> </tr> </thead> <tbody> <tr> <td>1-9</td> <td>\$180.09</td> </tr> <tr> <td>10-24</td> <td>\$171.09</td> </tr> <tr> <td>25-49</td> <td>\$162.08</td> </tr> <tr> <td>50+</td> <td>\$154.88</td> </tr> </tbody> </table> <p>QD N Male to N Female</p> <p>Model No: PE9547</p>	PRICE		1-9	\$180.09	10-24	\$171.09	25-49	\$162.08	50+	\$154.88
	PRICE																																																						
1-24	\$98.25																																																						
25-49	\$93.34																																																						
50-99	\$88.43																																																						
100+	\$84.50																																																						
PRICE																																																							
1-24	\$30.92																																																						
25-49	\$29.37																																																						
50-99	\$27.83																																																						
100+	\$26.59																																																						
PRICE																																																							
1-24	\$30.80																																																						
25-49	\$29.26																																																						
50-99	\$27.72																																																						
100+	\$26.49																																																						
PRICE																																																							
1-24	\$55.27																																																						
25-49	\$52.51																																																						
50-99	\$49.74																																																						
100+	\$47.53																																																						
PRICE																																																							
1-9	\$180.09																																																						
10-24	\$171.09																																																						
25-49	\$162.08																																																						
50+	\$154.88																																																						
5	 <table border="1"> <thead> <tr> <th colspan="2">PRICE</th> </tr> </thead> <tbody> <tr> <td>1-9</td> <td>\$296.93</td> </tr> <tr> <td>10-24</td> <td>\$285.05</td> </tr> <tr> <td>25-49</td> <td>\$276.14</td> </tr> <tr> <td>50+</td> <td>\$270.21</td> </tr> </tbody> </table> <p>PRECISION</p> <p>N Male to N Female Radius Right Angle</p> <p>VSWR 1.25:1 to 18 GHz</p> <p>Model No: PE91350</p>	PRICE		1-9	\$296.93	10-24	\$285.05	25-49	\$276.14	50+	\$270.21	 <table border="1"> <thead> <tr> <th colspan="2">PRICE</th> </tr> </thead> <tbody> <tr> <td>1-24</td> <td>\$22.13</td> </tr> <tr> <td>25-49</td> <td>\$21.02</td> </tr> <tr> <td>50-99</td> <td>\$19.92</td> </tr> <tr> <td>100+</td> <td>\$19.03</td> </tr> </tbody> </table> <p>N Male to N Female Right Angle</p> <p>VSWR 1.3:1 to 11 GHz</p> <p>Model No: PE9086</p>	PRICE		1-24	\$22.13	25-49	\$21.02	50-99	\$19.92	100+	\$19.03	 <table border="1"> <thead> <tr> <th colspan="2">PRICE</th> </tr> </thead> <tbody> <tr> <td>1-24</td> <td>\$98.47</td> </tr> <tr> <td>25-49</td> <td>\$93.55</td> </tr> <tr> <td>50-99</td> <td>\$88.62</td> </tr> <tr> <td>100+</td> <td>\$84.68</td> </tr> </tbody> </table> <p>N Male to N Female Tee</p> <p>Model No: PE9481</p>	PRICE		1-24	\$98.47	25-49	\$93.55	50-99	\$88.62	100+	\$84.68	 <table border="1"> <thead> <tr> <th colspan="2">PRICE</th> </tr> </thead> <tbody> <tr> <td>1-24</td> <td>\$44.95</td> </tr> <tr> <td>25-49</td> <td>\$42.70</td> </tr> <tr> <td>50-99</td> <td>\$40.46</td> </tr> <tr> <td>100+</td> <td>\$38.66</td> </tr> </tbody> </table> <p>N Male to N Female Bulkhead</p> <p>VSWR 1.3:1 to 11 GHz</p> <p>Model No: PE9595</p>	PRICE		1-24	\$44.95	25-49	\$42.70	50-99	\$40.46	100+	\$38.66	 <table border="1"> <thead> <tr> <th colspan="2">PRICE</th> </tr> </thead> <tbody> <tr> <td>1-24</td> <td>\$47.38</td> </tr> <tr> <td>25-49</td> <td>\$45.01</td> </tr> <tr> <td>50-99</td> <td>\$42.64</td> </tr> <tr> <td>100+</td> <td>\$40.75</td> </tr> </tbody> </table> <p>N Female to 75 Ohm N Male</p> <p>Max. Freq. 500 MHz</p> <p>Model No: PE9350</p>	PRICE		1-24	\$47.38	25-49	\$45.01	50-99	\$42.64	100+	\$40.75
	PRICE																																																						
1-9	\$296.93																																																						
10-24	\$285.05																																																						
25-49	\$276.14																																																						
50+	\$270.21																																																						
PRICE																																																							
1-24	\$22.13																																																						
25-49	\$21.02																																																						
50-99	\$19.92																																																						
100+	\$19.03																																																						
PRICE																																																							
1-24	\$98.47																																																						
25-49	\$93.55																																																						
50-99	\$88.62																																																						
100+	\$84.68																																																						
PRICE																																																							
1-24	\$44.95																																																						
25-49	\$42.70																																																						
50-99	\$40.46																																																						
100+	\$38.66																																																						
PRICE																																																							
1-24	\$47.38																																																						
25-49	\$45.01																																																						
50-99	\$42.64																																																						
100+	\$40.75																																																						
6	 <table border="1"> <thead> <tr> <th colspan="2">PRICE</th> </tr> </thead> <tbody> <tr> <td>1-24</td> <td>\$53.26</td> </tr> <tr> <td>25-49</td> <td>\$50.60</td> </tr> <tr> <td>50-99</td> <td>\$47.93</td> </tr> <tr> <td>100+</td> <td>\$45.80</td> </tr> </tbody> </table> <p>N Female to N Male Tee</p> <p>Max. Freq. 11 GHz</p> <p>Model No: PE9102</p>	PRICE		1-24	\$53.26	25-49	\$50.60	50-99	\$47.93	100+	\$45.80	 <table border="1"> <thead> <tr> <th colspan="2">PRICE</th> </tr> </thead> <tbody> <tr> <td>1-24</td> <td>\$58.19</td> </tr> <tr> <td>25-49</td> <td>\$55.28</td> </tr> <tr> <td>50-99</td> <td>\$52.37</td> </tr> <tr> <td>100+</td> <td>\$50.04</td> </tr> </tbody> </table> <p>N Female to N Female</p> <p>VSWR 1.2:1 to 6 GHz</p> <p>Model No: PE91200</p>	PRICE		1-24	\$58.19	25-49	\$55.28	50-99	\$52.37	100+	\$50.04	 <table border="1"> <thead> <tr> <th colspan="2">PRICE</th> </tr> </thead> <tbody> <tr> <td>1-24</td> <td>\$37.49</td> </tr> <tr> <td>25-49</td> <td>\$35.62</td> </tr> <tr> <td>50-99</td> <td>\$33.74</td> </tr> <tr> <td>100+</td> <td>\$32.24</td> </tr> </tbody> </table> <p>N Female to N Female</p> <p>VSWR 1.3:1 to 6 GHz</p> <p>Model No: PE91237</p>	PRICE		1-24	\$37.49	25-49	\$35.62	50-99	\$33.74	100+	\$32.24	 <table border="1"> <thead> <tr> <th colspan="2">PRICE</th> </tr> </thead> <tbody> <tr> <td>1-24</td> <td>\$17.85</td> </tr> <tr> <td>25-49</td> <td>\$16.96</td> </tr> <tr> <td>50-99</td> <td>\$16.07</td> </tr> <tr> <td>100+</td> <td>\$15.35</td> </tr> </tbody> </table> <p>N Female to N Female</p> <p>VSWR 1.3:1 to 11 GHz</p> <p>Model No: PE9006</p>	PRICE		1-24	\$17.85	25-49	\$16.96	50-99	\$16.07	100+	\$15.35	 <table border="1"> <thead> <tr> <th colspan="2">PRICE</th> </tr> </thead> <tbody> <tr> <td>1-24</td> <td>\$71.22</td> </tr> <tr> <td>25-49</td> <td>\$67.66</td> </tr> <tr> <td>50-99</td> <td>\$64.10</td> </tr> <tr> <td>100+</td> <td>\$61.25</td> </tr> </tbody> </table> <p>Low PIM</p> <p>N Female to N Female</p> <p>VSWR 1.2:1 to 6 GHz</p> <p>Model No: PE91140</p>	PRICE		1-24	\$71.22	25-49	\$67.66	50-99	\$64.10	100+	\$61.25
	PRICE																																																						
1-24	\$53.26																																																						
25-49	\$50.60																																																						
50-99	\$47.93																																																						
100+	\$45.80																																																						
PRICE																																																							
1-24	\$58.19																																																						
25-49	\$55.28																																																						
50-99	\$52.37																																																						
100+	\$50.04																																																						
PRICE																																																							
1-24	\$37.49																																																						
25-49	\$35.62																																																						
50-99	\$33.74																																																						
100+	\$32.24																																																						
PRICE																																																							
1-24	\$17.85																																																						
25-49	\$16.96																																																						
50-99	\$16.07																																																						
100+	\$15.35																																																						
PRICE																																																							
1-24	\$71.22																																																						
25-49	\$67.66																																																						
50-99	\$64.10																																																						
100+	\$61.25																																																						
7	 <table border="1"> <thead> <tr> <th colspan="2">PRICE</th> </tr> </thead> <tbody> <tr> <td>1-24</td> <td>\$47.60</td> </tr> <tr> <td>25-49</td> <td>\$45.22</td> </tr> <tr> <td>50-99</td> <td>\$42.84</td> </tr> <tr> <td>100+</td> <td>\$40.94</td> </tr> </tbody> </table> <p>N Female to N Female</p> <p>VSWR 1.2:1 to 18 GHz</p> <p>Model No: PE91141</p>	PRICE		1-24	\$47.60	25-49	\$45.22	50-99	\$42.84	100+	\$40.94	 <table border="1"> <thead> <tr> <th colspan="2">PRICE</th> </tr> </thead> <tbody> <tr> <td>1-24</td> <td>\$53.32</td> </tr> <tr> <td>25-49</td> <td>\$50.65</td> </tr> <tr> <td>50-99</td> <td>\$47.99</td> </tr> <tr> <td>100+</td> <td>\$45.86</td> </tr> </tbody> </table> <p>N Female to N Female Right Angle</p> <p>Model No: PE9359</p>	PRICE		1-24	\$53.32	25-49	\$50.65	50-99	\$47.99	100+	\$45.86	 <table border="1"> <thead> <tr> <th colspan="2">PRICE</th> </tr> </thead> <tbody> <tr> <td>1-24</td> <td>\$35.50</td> </tr> <tr> <td>25-49</td> <td>\$33.73</td> </tr> <tr> <td>50-99</td> <td>\$31.95</td> </tr> <tr> <td>100+</td> <td>\$30.53</td> </tr> </tbody> </table> <p>N Female to N Female Tee</p> <p>VSWR 2:1 to 100 MHz</p> <p>Model No: PE9101</p>	PRICE		1-24	\$35.50	25-49	\$33.73	50-99	\$31.95	100+	\$30.53	 <table border="1"> <thead> <tr> <th colspan="2">PRICE</th> </tr> </thead> <tbody> <tr> <td>1-24</td> <td>\$100.74</td> </tr> <tr> <td>25-49</td> <td>\$95.70</td> </tr> <tr> <td>50-99</td> <td>\$90.67</td> </tr> <tr> <td>100+</td> <td>\$86.64</td> </tr> </tbody> </table> <p>N Female to N Female Cross</p> <p>Model No: PE9548</p>	PRICE		1-24	\$100.74	25-49	\$95.70	50-99	\$90.67	100+	\$86.64	 <table border="1"> <thead> <tr> <th colspan="2">PRICE</th> </tr> </thead> <tbody> <tr> <td>1-24</td> <td>\$29.07</td> </tr> <tr> <td>25-49</td> <td>\$27.62</td> </tr> <tr> <td>50-99</td> <td>\$26.16</td> </tr> <tr> <td>100+</td> <td>\$25.00</td> </tr> </tbody> </table> <p>N Female to N Female Bulkhead</p> <p>VSWR 1.4:1 to 3 GHz</p> <p>Model No: PE9128</p>	PRICE		1-24	\$29.07	25-49	\$27.62	50-99	\$26.16	100+	\$25.00
	PRICE																																																						
1-24	\$47.60																																																						
25-49	\$45.22																																																						
50-99	\$42.84																																																						
100+	\$40.94																																																						
PRICE																																																							
1-24	\$53.32																																																						
25-49	\$50.65																																																						
50-99	\$47.99																																																						
100+	\$45.86																																																						
PRICE																																																							
1-24	\$35.50																																																						
25-49	\$33.73																																																						
50-99	\$31.95																																																						
100+	\$30.53																																																						
PRICE																																																							
1-24	\$100.74																																																						
25-49	\$95.70																																																						
50-99	\$90.67																																																						
100+	\$86.64																																																						
PRICE																																																							
1-24	\$29.07																																																						
25-49	\$27.62																																																						
50-99	\$26.16																																																						
100+	\$25.00																																																						



















ADAPTERS

See Adapter Locator on Pages 8-13

See Page 369 for Mounting Holes

Adapters

See Our Website For Current Pricing & Real-Time Stock Availability!

	A	B	C	D	E																																																		
1	 <table border="1"> <thead> <tr><th colspan="2">PRICE</th></tr> </thead> <tbody> <tr><td>1-24</td><td>\$73.69</td></tr> <tr><td>25-49</td><td>\$70.01</td></tr> <tr><td>50-99</td><td>\$66.32</td></tr> <tr><td>100+</td><td>\$63.37</td></tr> </tbody> </table> <p>N Female to N Female Bulkhead Max. Freq. 11 GHz</p> <p>Model No: PE9383</p>	PRICE		1-24	\$73.69	25-49	\$70.01	50-99	\$66.32	100+	\$63.37	 <table border="1"> <thead> <tr><th colspan="2">PRICE</th></tr> </thead> <tbody> <tr><td>1-24</td><td>\$78.04</td></tr> <tr><td>25-49</td><td>\$74.14</td></tr> <tr><td>50-99</td><td>\$70.24</td></tr> <tr><td>100+</td><td>\$67.11</td></tr> </tbody> </table> <p>N Female to N Female Right Angle Bulkhead-Mounting Hole G01 Max. Freq. 6 GHz</p> <p>Model No: PE9541</p>	PRICE		1-24	\$78.04	25-49	\$74.14	50-99	\$70.24	100+	\$67.11	 <table border="1"> <thead> <tr><th colspan="2">PRICE</th></tr> </thead> <tbody> <tr><td>1-24</td><td>\$31.85</td></tr> <tr><td>25-49</td><td>\$30.26</td></tr> <tr><td>50-99</td><td>\$28.67</td></tr> <tr><td>100+</td><td>\$27.39</td></tr> </tbody> </table> <p>N Female to N Female 4 Hole Flange-Mounting Hole A05 VSWR 1.5:1 to 11 GHz</p> <p>Model No: PE9173</p>	PRICE		1-24	\$31.85	25-49	\$30.26	50-99	\$28.67	100+	\$27.39	 <table border="1"> <thead> <tr><th colspan="2">PRICE</th></tr> </thead> <tbody> <tr><td>1-9</td><td>\$138.51</td></tr> <tr><td>10-24</td><td>\$131.58</td></tr> <tr><td>25-49</td><td>\$124.66</td></tr> <tr><td>50+</td><td>\$119.12</td></tr> </tbody> </table> <p>PRECISION N Female to N Female 4 Hole Flange-Mounting Hole A05 VSWR 1.15:1 to 18 GHz</p> <p>Model No: PE9429</p>	PRICE		1-9	\$138.51	10-24	\$131.58	25-49	\$124.66	50+	\$119.12	 <table border="1"> <thead> <tr><th colspan="2">PRICE</th></tr> </thead> <tbody> <tr><td>1-24</td><td>\$71.43</td></tr> <tr><td>25-49</td><td>\$67.86</td></tr> <tr><td>50-99</td><td>\$64.29</td></tr> <tr><td>100+</td><td>\$61.43</td></tr> </tbody> </table> <p>N Female to N Female Bulkhead VSWR 1.2:1 to 6 GHz</p> <p>Model No: PE91201</p>	PRICE		1-24	\$71.43	25-49	\$67.86	50-99	\$64.29	100+	\$61.43
	PRICE																																																						
1-24	\$73.69																																																						
25-49	\$70.01																																																						
50-99	\$66.32																																																						
100+	\$63.37																																																						
PRICE																																																							
1-24	\$78.04																																																						
25-49	\$74.14																																																						
50-99	\$70.24																																																						
100+	\$67.11																																																						
PRICE																																																							
1-24	\$31.85																																																						
25-49	\$30.26																																																						
50-99	\$28.67																																																						
100+	\$27.39																																																						
PRICE																																																							
1-9	\$138.51																																																						
10-24	\$131.58																																																						
25-49	\$124.66																																																						
50+	\$119.12																																																						
PRICE																																																							
1-24	\$71.43																																																						
25-49	\$67.86																																																						
50-99	\$64.29																																																						
100+	\$61.43																																																						
2	 <table border="1"> <thead> <tr><th colspan="2">PRICE</th></tr> </thead> <tbody> <tr><td>1-24</td><td>\$35.90</td></tr> <tr><td>25-49</td><td>\$34.11</td></tr> <tr><td>50-99</td><td>\$32.31</td></tr> <tr><td>100+</td><td>\$30.87</td></tr> </tbody> </table> <p>N Female to N Female Bulkhead VSWR 1.3:1 to 6 GHz</p> <p>Model No: PE91238</p>	PRICE		1-24	\$35.90	25-49	\$34.11	50-99	\$32.31	100+	\$30.87	 <table border="1"> <thead> <tr><th colspan="2">PRICE</th></tr> </thead> <tbody> <tr><td>1-24</td><td>\$63.79</td></tr> <tr><td>25-49</td><td>\$60.60</td></tr> <tr><td>50-99</td><td>\$57.41</td></tr> <tr><td>100+</td><td>\$54.86</td></tr> </tbody> </table> <p>Low PIM N Female to N Female Bulkhead VSWR 1.2:1 to 6 GHz</p> <p>Model No: PE91179</p>	PRICE		1-24	\$63.79	25-49	\$60.60	50-99	\$57.41	100+	\$54.86	 <table border="1"> <thead> <tr><th colspan="2">PRICE</th></tr> </thead> <tbody> <tr><td>1-9</td><td>\$182.28</td></tr> <tr><td>10-24</td><td>\$173.17</td></tr> <tr><td>25-49</td><td>\$164.05</td></tr> <tr><td>50+</td><td>\$156.76</td></tr> </tbody> </table> <p>PRECISION N Female to N Female Bulkhead VSWR 1.15:1 to 18 GHz</p> <p>Model No: PE9500</p>	PRICE		1-9	\$182.28	10-24	\$173.17	25-49	\$164.05	50+	\$156.76	 <table border="1"> <thead> <tr><th colspan="2">PRICE</th></tr> </thead> <tbody> <tr><td>1-24</td><td>\$45.25</td></tr> <tr><td>25-49</td><td>\$42.99</td></tr> <tr><td>50-99</td><td>\$40.73</td></tr> <tr><td>100+</td><td>\$38.92</td></tr> </tbody> </table> <p>N Female to N Female Bulkhead VSWR 1.5:1 to 11 GHz</p> <p>Model No: PE9382</p>	PRICE		1-24	\$45.25	25-49	\$42.99	50-99	\$40.73	100+	\$38.92	<p style="text-align: center;">Reverse Polarity N In-Series</p> <p style="text-align: center;">→</p>										
	PRICE																																																						
1-24	\$35.90																																																						
25-49	\$34.11																																																						
50-99	\$32.31																																																						
100+	\$30.87																																																						
PRICE																																																							
1-24	\$63.79																																																						
25-49	\$60.60																																																						
50-99	\$57.41																																																						
100+	\$54.86																																																						
PRICE																																																							
1-9	\$182.28																																																						
10-24	\$173.17																																																						
25-49	\$164.05																																																						
50+	\$156.76																																																						
PRICE																																																							
1-24	\$45.25																																																						
25-49	\$42.99																																																						
50-99	\$40.73																																																						
100+	\$38.92																																																						
3	 <table border="1"> <thead> <tr><th colspan="2">PRICE</th></tr> </thead> <tbody> <tr><td>1-24</td><td>\$42.97</td></tr> <tr><td>25-49</td><td>\$40.82</td></tr> <tr><td>50-99</td><td>\$38.67</td></tr> <tr><td>100+</td><td>\$36.95</td></tr> </tbody> </table> <p>N Male to Rev. Pol. N Female Max. Freq. 11 GHz</p> <p>Model No: PE9771</p>	PRICE		1-24	\$42.97	25-49	\$40.82	50-99	\$38.67	100+	\$36.95	 <table border="1"> <thead> <tr><th colspan="2">PRICE</th></tr> </thead> <tbody> <tr><td>1-24</td><td>\$42.32</td></tr> <tr><td>25-49</td><td>\$40.20</td></tr> <tr><td>50-99</td><td>\$38.09</td></tr> <tr><td>100+</td><td>\$36.40</td></tr> </tbody> </table> <p>N Female to Rev. Pol. N Male Max. Freq. 11 GHz</p> <p>Model No: PE9770</p>	PRICE		1-24	\$42.32	25-49	\$40.20	50-99	\$38.09	100+	\$36.40	 <table border="1"> <thead> <tr><th colspan="2">PRICE</th></tr> </thead> <tbody> <tr><td>1-24</td><td>\$42.97</td></tr> <tr><td>25-49</td><td>\$40.82</td></tr> <tr><td>50-99</td><td>\$38.67</td></tr> <tr><td>100+</td><td>\$36.95</td></tr> </tbody> </table> <p>Rev. Pol. N Female to Rev. Pol. N Female VSWR 1.3:1 to 11 GHz</p> <p>Model No: PE9773</p>	PRICE		1-24	\$42.97	25-49	\$40.82	50-99	\$38.67	100+	\$36.95	<p style="text-align: center;">N Between Series</p> <p style="text-align: center;">→</p>	 <table border="1"> <thead> <tr><th colspan="2">PRICE</th></tr> </thead> <tbody> <tr><td>1-9</td><td>\$299.19</td></tr> <tr><td>10-24</td><td>\$284.23</td></tr> <tr><td>25-49</td><td>\$269.27</td></tr> <tr><td>50+</td><td>\$257.30</td></tr> </tbody> </table> <p>PRECISION N Male to 7mm Sexless VSWR 1.12:1 to 18 GHz</p> <p>Model No: PE9217</p>	PRICE		1-9	\$299.19	10-24	\$284.23	25-49	\$269.27	50+	\$257.30										
	PRICE																																																						
1-24	\$42.97																																																						
25-49	\$40.82																																																						
50-99	\$38.67																																																						
100+	\$36.95																																																						
PRICE																																																							
1-24	\$42.32																																																						
25-49	\$40.20																																																						
50-99	\$38.09																																																						
100+	\$36.40																																																						
PRICE																																																							
1-24	\$42.97																																																						
25-49	\$40.82																																																						
50-99	\$38.67																																																						
100+	\$36.95																																																						
PRICE																																																							
1-9	\$299.19																																																						
10-24	\$284.23																																																						
25-49	\$269.27																																																						
50+	\$257.30																																																						
4	 <table border="1"> <thead> <tr><th colspan="2">PRICE</th></tr> </thead> <tbody> <tr><td>1-24</td><td>\$73.94</td></tr> <tr><td>25-49</td><td>\$70.24</td></tr> <tr><td>50-99</td><td>\$66.55</td></tr> <tr><td>100+</td><td>\$63.59</td></tr> </tbody> </table> <p>Low PIM NEW N Male to 4.3-10 Female VSWR 1.08:1 to 6 GHz</p> <p>Model No: PE91388</p>	PRICE		1-24	\$73.94	25-49	\$70.24	50-99	\$66.55	100+	\$63.59	 <table border="1"> <thead> <tr><th colspan="2">PRICE</th></tr> </thead> <tbody> <tr><td>1-24</td><td>\$91.69</td></tr> <tr><td>25-49</td><td>\$87.11</td></tr> <tr><td>50-99</td><td>\$82.52</td></tr> <tr><td>100+</td><td>\$78.85</td></tr> </tbody> </table> <p>Low PIM N Male to 7/16 DIN Male Max. Freq. 8 GHz</p> <p>Model No: PE91030</p>	PRICE		1-24	\$91.69	25-49	\$87.11	50-99	\$82.52	100+	\$78.85	 <table border="1"> <thead> <tr><th colspan="2">PRICE</th></tr> </thead> <tbody> <tr><td>1-9</td><td>\$196.62</td></tr> <tr><td>10-24</td><td>\$186.79</td></tr> <tr><td>25-49</td><td>\$176.96</td></tr> <tr><td>50+</td><td>\$169.09</td></tr> </tbody> </table> <p>N Male to 7/16 DIN Male</p> <p>Model No: PE9535</p>	PRICE		1-9	\$196.62	10-24	\$186.79	25-49	\$176.96	50+	\$169.09	 <table border="1"> <thead> <tr><th colspan="2">PRICE</th></tr> </thead> <tbody> <tr><td>1-24</td><td>\$98.25</td></tr> <tr><td>25-49</td><td>\$93.34</td></tr> <tr><td>50-99</td><td>\$88.43</td></tr> <tr><td>100+</td><td>\$84.50</td></tr> </tbody> </table> <p>Low PIM N Male to 7/16 DIN Female Max. Freq. 8 GHz</p> <p>Model No: PE91032</p>	PRICE		1-24	\$98.25	25-49	\$93.34	50-99	\$88.43	100+	\$84.50	 <table border="1"> <thead> <tr><th colspan="2">PRICE</th></tr> </thead> <tbody> <tr><td>1-24</td><td>\$87.21</td></tr> <tr><td>25-49</td><td>\$82.85</td></tr> <tr><td>50-99</td><td>\$78.49</td></tr> <tr><td>100+</td><td>\$75.00</td></tr> </tbody> </table> <p>N Male to 7/16 DIN Female VSWR 1.15:1 to 6 GHz</p> <p>Model No: PE91134</p>	PRICE		1-24	\$87.21	25-49	\$82.85	50-99	\$78.49	100+	\$75.00
	PRICE																																																						
1-24	\$73.94																																																						
25-49	\$70.24																																																						
50-99	\$66.55																																																						
100+	\$63.59																																																						
PRICE																																																							
1-24	\$91.69																																																						
25-49	\$87.11																																																						
50-99	\$82.52																																																						
100+	\$78.85																																																						
PRICE																																																							
1-9	\$196.62																																																						
10-24	\$186.79																																																						
25-49	\$176.96																																																						
50+	\$169.09																																																						
PRICE																																																							
1-24	\$98.25																																																						
25-49	\$93.34																																																						
50-99	\$88.43																																																						
100+	\$84.50																																																						
PRICE																																																							
1-24	\$87.21																																																						
25-49	\$82.85																																																						
50-99	\$78.49																																																						
100+	\$75.00																																																						
5	 <table border="1"> <thead> <tr><th colspan="2">PRICE</th></tr> </thead> <tbody> <tr><td>1-24</td><td>\$44.52</td></tr> <tr><td>25-49</td><td>\$42.29</td></tr> <tr><td>50-99</td><td>\$40.07</td></tr> <tr><td>100+</td><td>\$38.29</td></tr> </tbody> </table> <p>N Male to BNC Male VSWR 1.3:1 to 4 GHz</p> <p>Model No: PE9127</p>	PRICE		1-24	\$44.52	25-49	\$42.29	50-99	\$40.07	100+	\$38.29	 <table border="1"> <thead> <tr><th colspan="2">PRICE</th></tr> </thead> <tbody> <tr><td>1-9</td><td>\$192.88</td></tr> <tr><td>10-24</td><td>\$183.24</td></tr> <tr><td>25-49</td><td>\$173.59</td></tr> <tr><td>50+</td><td>\$165.88</td></tr> </tbody> </table> <p>PRECISION N Male to BNC Male VSWR 1.2:1 to 8 GHz</p> <p>Model No: PE9489</p>	PRICE		1-9	\$192.88	10-24	\$183.24	25-49	\$173.59	50+	\$165.88	 <table border="1"> <thead> <tr><th colspan="2">PRICE</th></tr> </thead> <tbody> <tr><td>1-24</td><td>\$100.61</td></tr> <tr><td>25-49</td><td>\$95.58</td></tr> <tr><td>50-99</td><td>\$90.55</td></tr> <tr><td>100+</td><td>\$86.52</td></tr> </tbody> </table> <p>N Male to BNC Male Right Angle</p> <p>Model No: PE9565</p>	PRICE		1-24	\$100.61	25-49	\$95.58	50-99	\$90.55	100+	\$86.52	 <table border="1"> <thead> <tr><th colspan="2">PRICE</th></tr> </thead> <tbody> <tr><td>1-24</td><td>\$23.25</td></tr> <tr><td>25-49</td><td>\$22.09</td></tr> <tr><td>50-99</td><td>\$20.93</td></tr> <tr><td>100+</td><td>\$20.00</td></tr> </tbody> </table> <p>N Male to BNC Female VSWR 1.3:1 to 2 GHz</p> <p>Model No: PE9002</p>	PRICE		1-24	\$23.25	25-49	\$22.09	50-99	\$20.93	100+	\$20.00	 <table border="1"> <thead> <tr><th colspan="2">PRICE</th></tr> </thead> <tbody> <tr><td>1-9</td><td>\$140.27</td></tr> <tr><td>10-24</td><td>\$133.26</td></tr> <tr><td>25-49</td><td>\$126.24</td></tr> <tr><td>50+</td><td>\$120.63</td></tr> </tbody> </table> <p>PRECISION N Male to BNC Female VSWR 1.2:1 to 8 GHz</p> <p>Model No: PE9491</p>	PRICE		1-9	\$140.27	10-24	\$133.26	25-49	\$126.24	50+	\$120.63
	PRICE																																																						
1-24	\$44.52																																																						
25-49	\$42.29																																																						
50-99	\$40.07																																																						
100+	\$38.29																																																						
PRICE																																																							
1-9	\$192.88																																																						
10-24	\$183.24																																																						
25-49	\$173.59																																																						
50+	\$165.88																																																						
PRICE																																																							
1-24	\$100.61																																																						
25-49	\$95.58																																																						
50-99	\$90.55																																																						
100+	\$86.52																																																						
PRICE																																																							
1-24	\$23.25																																																						
25-49	\$22.09																																																						
50-99	\$20.93																																																						
100+	\$20.00																																																						
PRICE																																																							
1-9	\$140.27																																																						
10-24	\$133.26																																																						
25-49	\$126.24																																																						
50+	\$120.63																																																						
6	 <table border="1"> <thead> <tr><th colspan="2">PRICE</th></tr> </thead> <tbody> <tr><td>1-24</td><td>\$83.12</td></tr> <tr><td>25-49</td><td>\$78.96</td></tr> <tr><td>50-99</td><td>\$74.81</td></tr> <tr><td>100+</td><td>\$71.48</td></tr> </tbody> </table> <p>N Male to BNC Female Right Angle VSWR 1.2:1 to 4 GHz</p> <p>Model No: PE9278</p>	PRICE		1-24	\$83.12	25-49	\$78.96	50-99	\$74.81	100+	\$71.48	 <table border="1"> <thead> <tr><th colspan="2">PRICE</th></tr> </thead> <tbody> <tr><td>1-24</td><td>\$62.86</td></tr> <tr><td>25-49</td><td>\$59.72</td></tr> <tr><td>50-99</td><td>\$56.57</td></tr> <tr><td>100+</td><td>\$54.06</td></tr> </tbody> </table> <p>N Male to BNC Female 4 Hole Flange Max. Freq. 4 GHz</p> <p>Model No: PE9388</p>	PRICE		1-24	\$62.86	25-49	\$59.72	50-99	\$56.57	100+	\$54.06	 <table border="1"> <thead> <tr><th colspan="2">PRICE</th></tr> </thead> <tbody> <tr><td>1-24</td><td>\$100.33</td></tr> <tr><td>25-49</td><td>\$95.31</td></tr> <tr><td>50-99</td><td>\$90.30</td></tr> <tr><td>100+</td><td>\$86.28</td></tr> </tbody> </table> <p>N Male to C Male</p> <p>Model No: PE9538</p>	PRICE		1-24	\$100.33	25-49	\$95.31	50-99	\$90.30	100+	\$86.28	 <table border="1"> <thead> <tr><th colspan="2">PRICE</th></tr> </thead> <tbody> <tr><td>1-24</td><td>\$62.73</td></tr> <tr><td>25-49</td><td>\$59.59</td></tr> <tr><td>50-99</td><td>\$56.46</td></tr> <tr><td>100+</td><td>\$53.95</td></tr> </tbody> </table> <p>N Male to C Female Max. Freq. 11 GHz</p> <p>Model No: PE91446</p>	PRICE		1-24	\$62.73	25-49	\$59.59	50-99	\$56.46	100+	\$53.95	 <table border="1"> <thead> <tr><th colspan="2">PRICE</th></tr> </thead> <tbody> <tr><td>1-24</td><td>\$106.59</td></tr> <tr><td>25-49</td><td>\$101.26</td></tr> <tr><td>50-99</td><td>\$95.93</td></tr> <tr><td>100+</td><td>\$91.67</td></tr> </tbody> </table> <p>N Male to C Female Right Angle Max. Freq. 4 GHz</p> <p>Model No: PE9239</p>	PRICE		1-24	\$106.59	25-49	\$101.26	50-99	\$95.93	100+	\$91.67
	PRICE																																																						
1-24	\$83.12																																																						
25-49	\$78.96																																																						
50-99	\$74.81																																																						
100+	\$71.48																																																						
PRICE																																																							
1-24	\$62.86																																																						
25-49	\$59.72																																																						
50-99	\$56.57																																																						
100+	\$54.06																																																						
PRICE																																																							
1-24	\$100.33																																																						
25-49	\$95.31																																																						
50-99	\$90.30																																																						
100+	\$86.28																																																						
PRICE																																																							
1-24	\$62.73																																																						
25-49	\$59.59																																																						
50-99	\$56.46																																																						
100+	\$53.95																																																						
PRICE																																																							
1-24	\$106.59																																																						
25-49	\$101.26																																																						
50-99	\$95.93																																																						
100+	\$91.67																																																						
7	 <table border="1"> <thead> <tr><th colspan="2">PRICE</th></tr> </thead> <tbody> <tr><td>1-24</td><td>\$28.85</td></tr> <tr><td>25-49</td><td>\$27.41</td></tr> <tr><td>50-99</td><td>\$25.97</td></tr> <tr><td>100+</td><td>\$24.81</td></tr> </tbody> </table> <p>N Male to 75 Ohm F Female VSWR 1.3:1 to 250 MHz</p> <p>Model No: PE9155</p>	PRICE		1-24	\$28.85	25-49	\$27.41	50-99	\$25.97	100+	\$24.81	 <table border="1"> <thead> <tr><th colspan="2">PRICE</th></tr> </thead> <tbody> <tr><td>1-24</td><td>\$23.62</td></tr> <tr><td>25-49</td><td>\$22.44</td></tr> <tr><td>50-99</td><td>\$21.26</td></tr> <tr><td>100+</td><td>\$20.31</td></tr> </tbody> </table> <p>N Male to FME Plug</p> <p>Model No: PE9704</p>	PRICE		1-24	\$23.62	25-49	\$22.44	50-99	\$21.26	100+	\$20.31	 <table border="1"> <thead> <tr><th colspan="2">PRICE</th></tr> </thead> <tbody> <tr><td>1-9</td><td>\$182.70</td></tr> <tr><td>10-24</td><td>\$173.57</td></tr> <tr><td>25-49</td><td>\$164.43</td></tr> <tr><td>50+</td><td>\$157.12</td></tr> </tbody> </table> <p>N Male to GR874 Sexless</p> <p>Model No: PE9257</p>	PRICE		1-9	\$182.70	10-24	\$173.57	25-49	\$164.43	50+	\$157.12	 <table border="1"> <thead> <tr><th colspan="2">PRICE</th></tr> </thead> <tbody> <tr><td>1-24</td><td>\$81.04</td></tr> <tr><td>25-49</td><td>\$76.99</td></tr> <tr><td>50-99</td><td>\$72.94</td></tr> <tr><td>100+</td><td>\$69.69</td></tr> </tbody> </table> <p>N Male to HN Male</p> <p>Model No: PE9554</p>	PRICE		1-24	\$81.04	25-49	\$76.99	50-99	\$72.94	100+	\$69.69	 <table border="1"> <thead> <tr><th colspan="2">PRICE</th></tr> </thead> <tbody> <tr><td>1-24</td><td>\$51.96</td></tr> <tr><td>25-49</td><td>\$49.36</td></tr> <tr><td>50-99</td><td>\$46.76</td></tr> <tr><td>100+</td><td>\$44.69</td></tr> </tbody> </table> <p>N Male to HN Female VSWR 1.3:1 to 4 GHz</p> <p>Model No: PE9125</p>	PRICE		1-24	\$51.96	25-49	\$49.36	50-99	\$46.76	100+	\$44.69
	PRICE																																																						
1-24	\$28.85																																																						
25-49	\$27.41																																																						
50-99	\$25.97																																																						
100+	\$24.81																																																						
PRICE																																																							
1-24	\$23.62																																																						
25-49	\$22.44																																																						
50-99	\$21.26																																																						
100+	\$20.31																																																						
PRICE																																																							
1-9	\$182.70																																																						
10-24	\$173.57																																																						
25-49	\$164.43																																																						
50+	\$157.12																																																						
PRICE																																																							
1-24	\$81.04																																																						
25-49	\$76.99																																																						
50-99	\$72.94																																																						
100+	\$69.69																																																						
PRICE																																																							
1-24	\$51.96																																																						
25-49	\$49.36																																																						
50-99	\$46.76																																																						
100+	\$44.69																																																						

ADAPTERS

See Adapter Locator on Pages 8-13

See Page 369 for Mounting Holes

	A	B	C	D	E																																													
1	 <table border="1"> <thead> <tr><th>PRICE</th></tr> </thead> <tbody> <tr><td>1-9</td><td>\$193.43</td></tr> <tr><td>10-24</td><td>\$183.76</td></tr> <tr><td>25-49</td><td>\$174.09</td></tr> <tr><td>50+</td><td>\$166.35</td></tr> </tbody> </table> <p>N Male to LC Female</p> <p>Model No: PE9299</p>	PRICE	1-9	\$193.43	10-24	\$183.76	25-49	\$174.09	50+	\$166.35	 <table border="1"> <thead> <tr><th>PRICE</th></tr> </thead> <tbody> <tr><td>1-24</td><td>\$89.44</td></tr> <tr><td>25-49</td><td>\$85.86</td></tr> <tr><td>50-99</td><td>\$83.18</td></tr> <tr><td>100+</td><td>\$81.39</td></tr> </tbody> </table> <p>N Male to MCX Plug</p> <p>Model No: PE9465</p>	PRICE	1-24	\$89.44	25-49	\$85.86	50-99	\$83.18	100+	\$81.39	 <table border="1"> <thead> <tr><th>PRICE</th></tr> </thead> <tbody> <tr><td>1-9</td><td>\$128.20</td></tr> <tr><td>10-24</td><td>\$121.79</td></tr> <tr><td>25-49</td><td>\$115.38</td></tr> <tr><td>50+</td><td>\$110.25</td></tr> </tbody> </table> <p>N Male to MCX Jack</p> <p>Max. Freq. 6 GHz</p> <p>Model No: PE9464</p>	PRICE	1-9	\$128.20	10-24	\$121.79	25-49	\$115.38	50+	\$110.25	 <table border="1"> <thead> <tr><th>PRICE</th></tr> </thead> <tbody> <tr><td>1-24</td><td>\$23.96</td></tr> <tr><td>25-49</td><td>\$22.76</td></tr> <tr><td>50-99</td><td>\$21.56</td></tr> <tr><td>100+</td><td>\$20.61</td></tr> </tbody> </table> <p>N Male to Mini UHF Female</p> <p>Max. Freq. 2.5 GHz</p> <p>Model No: PE9064</p>	PRICE	1-24	\$23.96	25-49	\$22.76	50-99	\$21.56	100+	\$20.61	 <table border="1"> <thead> <tr><th>PRICE</th></tr> </thead> <tbody> <tr><td>1-9</td><td>\$211.54</td></tr> <tr><td>10-24</td><td>\$200.96</td></tr> <tr><td>25-49</td><td>\$190.39</td></tr> <tr><td>50+</td><td>\$181.92</td></tr> </tbody> </table> <p>N Male to QMA Female</p> <p>Max. Freq. 11 GHz</p> <p>Model No: PE9787</p>	PRICE	1-9	\$211.54	10-24	\$200.96	25-49	\$190.39	50+	\$181.92
	PRICE																																																	
1-9	\$193.43																																																	
10-24	\$183.76																																																	
25-49	\$174.09																																																	
50+	\$166.35																																																	
PRICE																																																		
1-24	\$89.44																																																	
25-49	\$85.86																																																	
50-99	\$83.18																																																	
100+	\$81.39																																																	
PRICE																																																		
1-9	\$128.20																																																	
10-24	\$121.79																																																	
25-49	\$115.38																																																	
50+	\$110.25																																																	
PRICE																																																		
1-24	\$23.96																																																	
25-49	\$22.76																																																	
50-99	\$21.56																																																	
100+	\$20.61																																																	
PRICE																																																		
1-9	\$211.54																																																	
10-24	\$200.96																																																	
25-49	\$190.39																																																	
50+	\$181.92																																																	
2	 <table border="1"> <thead> <tr><th>PRICE</th></tr> </thead> <tbody> <tr><td>1-9</td><td>\$121.83</td></tr> <tr><td>10-24</td><td>\$115.74</td></tr> <tr><td>25-49</td><td>\$109.65</td></tr> <tr><td>50+</td><td>\$104.77</td></tr> </tbody> </table> <p>N Male to SC Male</p> <p>Model No: PE9570</p>	PRICE	1-9	\$121.83	10-24	\$115.74	25-49	\$109.65	50+	\$104.77	 <table border="1"> <thead> <tr><th>PRICE</th></tr> </thead> <tbody> <tr><td>1-9</td><td>\$108.71</td></tr> <tr><td>10-24</td><td>\$103.27</td></tr> <tr><td>25-49</td><td>\$97.84</td></tr> <tr><td>50+</td><td>\$93.49</td></tr> </tbody> </table> <p>N Male to SC Female</p> <p>VSWR 1.25:1 to 11 GHz</p> <p>Model No: PE9196</p>	PRICE	1-9	\$108.71	10-24	\$103.27	25-49	\$97.84	50+	\$93.49	 <table border="1"> <thead> <tr><th>PRICE</th></tr> </thead> <tbody> <tr><td>1-24</td><td>\$51.36</td></tr> <tr><td>25-49</td><td>\$48.79</td></tr> <tr><td>50-99</td><td>\$46.22</td></tr> <tr><td>100+</td><td>\$44.17</td></tr> </tbody> </table> <p>Low PIM</p> <p>N Male to SMA Female</p> <p>VSWR 1.2:1 to 6 GHz</p> <p>Model No: PE91177</p>	PRICE	1-24	\$51.36	25-49	\$48.79	50-99	\$46.22	100+	\$44.17	 <table border="1"> <thead> <tr><th>PRICE</th></tr> </thead> <tbody> <tr><td>1-24</td><td>\$96.96</td></tr> <tr><td>25-49</td><td>\$92.11</td></tr> <tr><td>50-99</td><td>\$87.26</td></tr> <tr><td>100+</td><td>\$83.39</td></tr> </tbody> </table> <p>N Male to SMB Plug</p> <p>Model No: PE9314</p>	PRICE	1-24	\$96.96	25-49	\$92.11	50-99	\$87.26	100+	\$83.39	 <table border="1"> <thead> <tr><th>PRICE</th></tr> </thead> <tbody> <tr><td>1-24</td><td>\$69.80</td></tr> <tr><td>25-49</td><td>\$66.31</td></tr> <tr><td>50-99</td><td>\$62.82</td></tr> <tr><td>100+</td><td>\$60.03</td></tr> </tbody> </table> <p>N Male to SMB Jack</p> <p>Model No: PE9313</p>	PRICE	1-24	\$69.80	25-49	\$66.31	50-99	\$62.82	100+	\$60.03
	PRICE																																																	
1-9	\$121.83																																																	
10-24	\$115.74																																																	
25-49	\$109.65																																																	
50+	\$104.77																																																	
PRICE																																																		
1-9	\$108.71																																																	
10-24	\$103.27																																																	
25-49	\$97.84																																																	
50+	\$93.49																																																	
PRICE																																																		
1-24	\$51.36																																																	
25-49	\$48.79																																																	
50-99	\$46.22																																																	
100+	\$44.17																																																	
PRICE																																																		
1-24	\$96.96																																																	
25-49	\$92.11																																																	
50-99	\$87.26																																																	
100+	\$83.39																																																	
PRICE																																																		
1-24	\$69.80																																																	
25-49	\$66.31																																																	
50-99	\$62.82																																																	
100+	\$60.03																																																	
3	 <table border="1"> <thead> <tr><th>PRICE</th></tr> </thead> <tbody> <tr><td>1-24</td><td>\$95.42</td></tr> <tr><td>25-49</td><td>\$90.65</td></tr> <tr><td>50-99</td><td>\$85.88</td></tr> <tr><td>100+</td><td>\$82.06</td></tr> </tbody> </table> <p>N Male to SMC Plug</p> <p>Model No: PE9318</p>	PRICE	1-24	\$95.42	25-49	\$90.65	50-99	\$85.88	100+	\$82.06	 <table border="1"> <thead> <tr><th>PRICE</th></tr> </thead> <tbody> <tr><td>1-24</td><td>\$84.35</td></tr> <tr><td>25-49</td><td>\$80.13</td></tr> <tr><td>50-99</td><td>\$75.92</td></tr> <tr><td>100+</td><td>\$72.54</td></tr> </tbody> </table> <p>N Male to SMC Jack</p> <p>Model No: PE9317</p>	PRICE	1-24	\$84.35	25-49	\$80.13	50-99	\$75.92	100+	\$72.54	 <table border="1"> <thead> <tr><th>PRICE</th></tr> </thead> <tbody> <tr><td>1-24</td><td>\$24.82</td></tr> <tr><td>25-49</td><td>\$23.58</td></tr> <tr><td>50-99</td><td>\$22.34</td></tr> <tr><td>100+</td><td>\$21.35</td></tr> </tbody> </table> <p>N Male to TNC Male</p> <p>VSWR 1.5:1 to 11 GHz</p> <p>Model No: PE9130</p>	PRICE	1-24	\$24.82	25-49	\$23.58	50-99	\$22.34	100+	\$21.35	 <table border="1"> <thead> <tr><th>PRICE</th></tr> </thead> <tbody> <tr><td>1-9</td><td>\$154.34</td></tr> <tr><td>10-24</td><td>\$146.62</td></tr> <tr><td>25-49</td><td>\$138.91</td></tr> <tr><td>50+</td><td>\$132.73</td></tr> </tbody> </table> <p>PRECISION</p> <p>N Male to TNC Male</p> <p>VSWR 1.15:1 to 18 GHz</p> <p>Model No: PE9446</p>	PRICE	1-9	\$154.34	10-24	\$146.62	25-49	\$138.91	50+	\$132.73	 <table border="1"> <thead> <tr><th>PRICE</th></tr> </thead> <tbody> <tr><td>1-24</td><td>\$22.50</td></tr> <tr><td>25-49</td><td>\$21.38</td></tr> <tr><td>50-99</td><td>\$20.25</td></tr> <tr><td>100+</td><td>\$19.35</td></tr> </tbody> </table> <p>N Male to TNC Female</p> <p>VSWR 1.5:1 to 1,000 MHz</p> <p>Model No: PE9090</p>	PRICE	1-24	\$22.50	25-49	\$21.38	50-99	\$20.25	100+	\$19.35
	PRICE																																																	
1-24	\$95.42																																																	
25-49	\$90.65																																																	
50-99	\$85.88																																																	
100+	\$82.06																																																	
PRICE																																																		
1-24	\$84.35																																																	
25-49	\$80.13																																																	
50-99	\$75.92																																																	
100+	\$72.54																																																	
PRICE																																																		
1-24	\$24.82																																																	
25-49	\$23.58																																																	
50-99	\$22.34																																																	
100+	\$21.35																																																	
PRICE																																																		
1-9	\$154.34																																																	
10-24	\$146.62																																																	
25-49	\$138.91																																																	
50+	\$132.73																																																	
PRICE																																																		
1-24	\$22.50																																																	
25-49	\$21.38																																																	
50-99	\$20.25																																																	
100+	\$19.35																																																	
4	 <table border="1"> <thead> <tr><th>PRICE</th></tr> </thead> <tbody> <tr><td>1-9</td><td>\$128.42</td></tr> <tr><td>10-24</td><td>\$122.00</td></tr> <tr><td>25-49</td><td>\$115.58</td></tr> <tr><td>50+</td><td>\$110.44</td></tr> </tbody> </table> <p>PRECISION</p> <p>N Male to TNC Female</p> <p>VSWR 1.15:1 to 18 GHz</p> <p>Model No: PE9448</p>	PRICE	1-9	\$128.42	10-24	\$122.00	25-49	\$115.58	50+	\$110.44	 <table border="1"> <thead> <tr><th>PRICE</th></tr> </thead> <tbody> <tr><td>1-24</td><td>\$83.38</td></tr> <tr><td>25-49</td><td>\$79.21</td></tr> <tr><td>50-99</td><td>\$75.04</td></tr> <tr><td>100+</td><td>\$71.71</td></tr> </tbody> </table> <p>N Male to TNC Female Right Angle</p> <p>VSWR 1.33:1 to 6 GHz</p> <p>Model No: PE9550</p>	PRICE	1-24	\$83.38	25-49	\$79.21	50-99	\$75.04	100+	\$71.71	 <table border="1"> <thead> <tr><th>PRICE</th></tr> </thead> <tbody> <tr><td>1-24</td><td>\$35.87</td></tr> <tr><td>25-49</td><td>\$34.08</td></tr> <tr><td>50-99</td><td>\$32.28</td></tr> <tr><td>100+</td><td>\$30.85</td></tr> </tbody> </table> <p>N Male to UHF Male</p> <p>Model No: PE9113</p>	PRICE	1-24	\$35.87	25-49	\$34.08	50-99	\$32.28	100+	\$30.85	 <table border="1"> <thead> <tr><th>PRICE</th></tr> </thead> <tbody> <tr><td>1-24</td><td>\$33.60</td></tr> <tr><td>25-49</td><td>\$31.92</td></tr> <tr><td>50-99</td><td>\$30.24</td></tr> <tr><td>100+</td><td>\$28.90</td></tr> </tbody> </table> <p>N Male to UHF Female</p> <p>VSWR 1.3:1 to 300 MHz</p> <p>Model No: PE9111</p>	PRICE	1-24	\$33.60	25-49	\$31.92	50-99	\$30.24	100+	\$28.90	 <table border="1"> <thead> <tr><th>PRICE</th></tr> </thead> <tbody> <tr><td>1-9</td><td>\$308.07</td></tr> <tr><td>10-24</td><td>\$295.75</td></tr> <tr><td>25-49</td><td>\$286.51</td></tr> <tr><td>50+</td><td>\$280.34</td></tr> </tbody> </table> <p>PRECISION</p> <p>N Female to 7mm Sexless</p> <p>VSWR 1.15:1 to 18 GHz</p> <p>Model No: PE9216</p>	PRICE	1-9	\$308.07	10-24	\$295.75	25-49	\$286.51	50+	\$280.34
	PRICE																																																	
1-9	\$128.42																																																	
10-24	\$122.00																																																	
25-49	\$115.58																																																	
50+	\$110.44																																																	
PRICE																																																		
1-24	\$83.38																																																	
25-49	\$79.21																																																	
50-99	\$75.04																																																	
100+	\$71.71																																																	
PRICE																																																		
1-24	\$35.87																																																	
25-49	\$34.08																																																	
50-99	\$32.28																																																	
100+	\$30.85																																																	
PRICE																																																		
1-24	\$33.60																																																	
25-49	\$31.92																																																	
50-99	\$30.24																																																	
100+	\$28.90																																																	
PRICE																																																		
1-9	\$308.07																																																	
10-24	\$295.75																																																	
25-49	\$286.51																																																	
50+	\$280.34																																																	
5	 <table border="1"> <thead> <tr><th>PRICE</th></tr> </thead> <tbody> <tr><td>1-24</td><td>\$96.37</td></tr> <tr><td>25-49</td><td>\$91.55</td></tr> <tr><td>50-99</td><td>\$86.73</td></tr> <tr><td>100+</td><td>\$82.88</td></tr> </tbody> </table> <p>Low PIM</p> <p>N Female to 7/16 DIN Male</p> <p>Max. Freq. 8 GHz</p> <p>Model No: PE91031</p>	PRICE	1-24	\$96.37	25-49	\$91.55	50-99	\$86.73	100+	\$82.88	 <table border="1"> <thead> <tr><th>PRICE</th></tr> </thead> <tbody> <tr><td>1-24</td><td>\$98.25</td></tr> <tr><td>25-49</td><td>\$93.34</td></tr> <tr><td>50-99</td><td>\$88.43</td></tr> <tr><td>100+</td><td>\$84.50</td></tr> </tbody> </table> <p>Low PIM</p> <p>N Female to 7/16 DIN Female</p> <p>Max. Freq. 8 GHz</p> <p>Model No: PE91033</p>	PRICE	1-24	\$98.25	25-49	\$93.34	50-99	\$88.43	100+	\$84.50	 <table border="1"> <thead> <tr><th>PRICE</th></tr> </thead> <tbody> <tr><td>1-9</td><td>\$141.81</td></tr> <tr><td>10-24</td><td>\$134.72</td></tr> <tr><td>25-49</td><td>\$127.63</td></tr> <tr><td>50+</td><td>\$121.96</td></tr> </tbody> </table> <p>Low PIM</p> <p>N Female to 7/16 DIN Female</p> <p>Max. Freq. 8 GHz</p> <p>Model No: PE9180</p>	PRICE	1-9	\$141.81	10-24	\$134.72	25-49	\$127.63	50+	\$121.96	 <table border="1"> <thead> <tr><th>PRICE</th></tr> </thead> <tbody> <tr><td>1-24</td><td>\$21.79</td></tr> <tr><td>25-49</td><td>\$20.70</td></tr> <tr><td>50-99</td><td>\$19.61</td></tr> <tr><td>100+</td><td>\$18.74</td></tr> </tbody> </table> <p>N Female to BNC Male</p> <p>VSWR 1.3:1 to 4 GHz</p> <p>Model No: PE9005</p>	PRICE	1-24	\$21.79	25-49	\$20.70	50-99	\$19.61	100+	\$18.74	 <table border="1"> <thead> <tr><th>PRICE</th></tr> </thead> <tbody> <tr><td>1-9</td><td>\$139.08</td></tr> <tr><td>10-24</td><td>\$132.13</td></tr> <tr><td>25-49</td><td>\$125.17</td></tr> <tr><td>50+</td><td>\$119.61</td></tr> </tbody> </table> <p>PRECISION</p> <p>N Female to BNC Male</p> <p>VSWR 1.2:1 to 8 GHz</p> <p>Model No: PE9490</p>	PRICE	1-9	\$139.08	10-24	\$132.13	25-49	\$125.17	50+	\$119.61
	PRICE																																																	
1-24	\$96.37																																																	
25-49	\$91.55																																																	
50-99	\$86.73																																																	
100+	\$82.88																																																	
PRICE																																																		
1-24	\$98.25																																																	
25-49	\$93.34																																																	
50-99	\$88.43																																																	
100+	\$84.50																																																	
PRICE																																																		
1-9	\$141.81																																																	
10-24	\$134.72																																																	
25-49	\$127.63																																																	
50+	\$121.96																																																	
PRICE																																																		
1-24	\$21.79																																																	
25-49	\$20.70																																																	
50-99	\$19.61																																																	
100+	\$18.74																																																	
PRICE																																																		
1-9	\$139.08																																																	
10-24	\$132.13																																																	
25-49	\$125.17																																																	
50+	\$119.61																																																	
6	 <table border="1"> <thead> <tr><th>PRICE</th></tr> </thead> <tbody> <tr><td>1-24</td><td>\$61.97</td></tr> <tr><td>25-49</td><td>\$58.87</td></tr> <tr><td>50-99</td><td>\$55.77</td></tr> <tr><td>100+</td><td>\$53.29</td></tr> </tbody> </table> <p>N Female to BNC Male Right Angle</p> <p>Max. Freq. 4 GHz</p> <p>Model No: PE9566</p>	PRICE	1-24	\$61.97	25-49	\$58.87	50-99	\$55.77	100+	\$53.29	 <table border="1"> <thead> <tr><th>PRICE</th></tr> </thead> <tbody> <tr><td>1-24</td><td>\$81.58</td></tr> <tr><td>25-49</td><td>\$77.50</td></tr> <tr><td>50-99</td><td>\$73.42</td></tr> <tr><td>100+</td><td>\$70.16</td></tr> </tbody> </table> <p>N Female to BNC Male 4 Hole Flange-Mounting Hole A05</p> <p>Model No: PE9123</p>	PRICE	1-24	\$81.58	25-49	\$77.50	50-99	\$73.42	100+	\$70.16	 <table border="1"> <thead> <tr><th>PRICE</th></tr> </thead> <tbody> <tr><td>1-24</td><td>\$25.86</td></tr> <tr><td>25-49</td><td>\$24.57</td></tr> <tr><td>50-99</td><td>\$23.27</td></tr> <tr><td>100+</td><td>\$22.24</td></tr> </tbody> </table> <p>N Female to BNC Female</p> <p>VSWR 1.5:1 to 3 GHz</p> <p>Model No: PE9206</p>	PRICE	1-24	\$25.86	25-49	\$24.57	50-99	\$23.27	100+	\$22.24	 <table border="1"> <thead> <tr><th>PRICE</th></tr> </thead> <tbody> <tr><td>1-9</td><td>\$176.26</td></tr> <tr><td>10-24</td><td>\$167.45</td></tr> <tr><td>25-49</td><td>\$158.63</td></tr> <tr><td>50+</td><td>\$151.58</td></tr> </tbody> </table> <p>PRECISION</p> <p>N Female to BNC Female</p> <p>VSWR 1.2:1 to 8 GHz</p> <p>Model No: PE9492</p>	PRICE	1-9	\$176.26	10-24	\$167.45	25-49	\$158.63	50+	\$151.58	 <table border="1"> <thead> <tr><th>PRICE</th></tr> </thead> <tbody> <tr><td>1-24</td><td>\$65.04</td></tr> <tr><td>25-49</td><td>\$61.79</td></tr> <tr><td>50-99</td><td>\$58.54</td></tr> <tr><td>100+</td><td>\$55.93</td></tr> </tbody> </table> <p>N Female to BNC Female Bulkhead-Mounting Hole G01</p> <p>Model No: PE9261</p>	PRICE	1-24	\$65.04	25-49	\$61.79	50-99	\$58.54	100+	\$55.93
	PRICE																																																	
1-24	\$61.97																																																	
25-49	\$58.87																																																	
50-99	\$55.77																																																	
100+	\$53.29																																																	
PRICE																																																		
1-24	\$81.58																																																	
25-49	\$77.50																																																	
50-99	\$73.42																																																	
100+	\$70.16																																																	
PRICE																																																		
1-24	\$25.86																																																	
25-49	\$24.57																																																	
50-99	\$23.27																																																	
100+	\$22.24																																																	
PRICE																																																		
1-9	\$176.26																																																	
10-24	\$167.45																																																	
25-49	\$158.63																																																	
50+	\$151.58																																																	
PRICE																																																		
1-24	\$65.04																																																	
25-49	\$61.79																																																	
50-99	\$58.54																																																	
100+	\$55.93																																																	
7	 <table border="1"> <thead> <tr><th>PRICE</th></tr> </thead> <tbody> <tr><td>1-24</td><td>\$57.45</td></tr> <tr><td>25-49</td><td>\$54.58</td></tr> <tr><td>50-99</td><td>\$51.71</td></tr> <tr><td>100+</td><td>\$49.41</td></tr> </tbody> </table> <p>N Female to BNC Female 4 Hole Flange-Mounting Hole A05</p> <p>VSWR 1.2:1 to 6 GHz</p> <p>Model No: PE9238</p>	PRICE	1-24	\$57.45	25-49	\$54.58	50-99	\$51.71	100+	\$49.41	 <table border="1"> <thead> <tr><th>PRICE</th></tr> </thead> <tbody> <tr><td>1-24</td><td>\$69.32</td></tr> <tr><td>25-49</td><td>\$65.85</td></tr> <tr><td>50-99</td><td>\$62.39</td></tr> <tr><td>100+</td><td>\$59.62</td></tr> </tbody> </table> <p>N Female to BNC Female Bulkhead-Mounting Hole G01</p> <p>Max. Freq. 4 GHz</p> <p>Model No: PE9540</p>	PRICE	1-24	\$69.32	25-49	\$65.85	50-99	\$62.39	100+	\$59.62	 <table border="1"> <thead> <tr><th>PRICE</th></tr> </thead> <tbody> <tr><td>1-24</td><td>\$61.60</td></tr> <tr><td>25-49</td><td>\$58.52</td></tr> <tr><td>50-99</td><td>\$55.44</td></tr> <tr><td>100+</td><td>\$52.98</td></tr> </tbody> </table> <p>N Female to C Male</p> <p>VSWR 1.25:1 to 11 GHz</p> <p>Model No: PE9295</p>	PRICE	1-24	\$61.60	25-49	\$58.52	50-99	\$55.44	100+	\$52.98	 <table border="1"> <thead> <tr><th>PRICE</th></tr> </thead> <tbody> <tr><td>1-24</td><td>\$90.02</td></tr> <tr><td>25-49</td><td>\$85.52</td></tr> <tr><td>50-99</td><td>\$81.02</td></tr> <tr><td>100+</td><td>\$77.42</td></tr> </tbody> </table> <p>N Female to C Female</p> <p>Model No: PE9539</p>	PRICE	1-24	\$90.02	25-49	\$85.52	50-99	\$81.02	100+	\$77.42	 <table border="1"> <thead> <tr><th>PRICE</th></tr> </thead> <tbody> <tr><td>1-24</td><td>\$41.17</td></tr> <tr><td>25-49</td><td>\$39.11</td></tr> <tr><td>50-99</td><td>\$37.05</td></tr> <tr><td>100+</td><td>\$35.41</td></tr> </tbody> </table> <p>N Female to 75 Ohm F Male</p> <p>VSWR 1.3:1 to 250 MHz</p> <p>Model No: PE9389</p>	PRICE	1-24	\$41.17	25-49	\$39.11	50-99	\$37.05	100+	\$35.41
	PRICE																																																	
1-24	\$57.45																																																	
25-49	\$54.58																																																	
50-99	\$51.71																																																	
100+	\$49.41																																																	
PRICE																																																		
1-24	\$69.32																																																	
25-49	\$65.85																																																	
50-99	\$62.39																																																	
100+	\$59.62																																																	
PRICE																																																		
1-24	\$61.60																																																	
25-49	\$58.52																																																	
50-99	\$55.44																																																	
100+	\$52.98																																																	
PRICE																																																		
1-24	\$90.02																																																	
25-49	\$85.52																																																	
50-99	\$81.02																																																	
100+	\$77.42																																																	
PRICE																																																		
1-24	\$41.17																																																	
25-49	\$39.11																																																	
50-99	\$37.05																																																	
100+	\$35.41																																																	

ADAPTERS

See Adapter Locator on Pages 8-13

See Page 369 for Mounting Holes

Adapters

See Our Website For Current Pricing & Real-Time Stock Availability!

	A	B	C	D	E																																																		
1	 <table border="1"> <thead> <tr> <th colspan="2">PRICE</th> </tr> </thead> <tbody> <tr> <td>1-9</td> <td>\$177.46</td> </tr> <tr> <td>10-24</td> <td>\$168.59</td> </tr> <tr> <td>25-49</td> <td>\$159.71</td> </tr> <tr> <td>50+</td> <td>\$152.62</td> </tr> </tbody> </table> <p>N Female to GR874 Sexless</p> <p>Model No: PE9258</p>	PRICE		1-9	\$177.46	10-24	\$168.59	25-49	\$159.71	50+	\$152.62	 <table border="1"> <thead> <tr> <th colspan="2">PRICE</th> </tr> </thead> <tbody> <tr> <td>1-24</td> <td>\$52.97</td> </tr> <tr> <td>25-49</td> <td>\$50.32</td> </tr> <tr> <td>50-99</td> <td>\$47.67</td> </tr> <tr> <td>100+</td> <td>\$45.55</td> </tr> </tbody> </table> <p>N Female to HN Male</p> <p>VSWR 1.3:1 to 3 GHz</p> <p>Model No: PE9194</p>	PRICE		1-24	\$52.97	25-49	\$50.32	50-99	\$47.67	100+	\$45.55	 <table border="1"> <thead> <tr> <th colspan="2">PRICE</th> </tr> </thead> <tbody> <tr> <td>1-24</td> <td>\$75.55</td> </tr> <tr> <td>25-49</td> <td>\$71.77</td> </tr> <tr> <td>50-99</td> <td>\$68.00</td> </tr> <tr> <td>100+</td> <td>\$64.97</td> </tr> </tbody> </table> <p>N Female to HN Female</p> <p>Model No: PE9360</p>	PRICE		1-24	\$75.55	25-49	\$71.77	50-99	\$68.00	100+	\$64.97	 <table border="1"> <thead> <tr> <th colspan="2">PRICE</th> </tr> </thead> <tbody> <tr> <td>1-24</td> <td>\$113.65</td> </tr> <tr> <td>25-49</td> <td>\$107.97</td> </tr> <tr> <td>50-99</td> <td>\$102.29</td> </tr> <tr> <td>100+</td> <td>\$97.74</td> </tr> </tbody> </table> <p>N Female to HN Female 4 Hole Flange-Mounting Hole A08</p> <p>Model No: PE9553</p>	PRICE		1-24	\$113.65	25-49	\$107.97	50-99	\$102.29	100+	\$97.74	 <table border="1"> <thead> <tr> <th colspan="2">PRICE</th> </tr> </thead> <tbody> <tr> <td>1-9</td> <td>\$241.94</td> </tr> <tr> <td>10-24</td> <td>\$229.84</td> </tr> <tr> <td>25-49</td> <td>\$217.75</td> </tr> <tr> <td>50+</td> <td>\$208.07</td> </tr> </tbody> </table> <p>N Female to LC Male</p> <p>Max. Freq. 1,000 MHz</p> <p>Model No: PE9237</p>	PRICE		1-9	\$241.94	10-24	\$229.84	25-49	\$217.75	50+	\$208.07
	PRICE																																																						
1-9	\$177.46																																																						
10-24	\$168.59																																																						
25-49	\$159.71																																																						
50+	\$152.62																																																						
PRICE																																																							
1-24	\$52.97																																																						
25-49	\$50.32																																																						
50-99	\$47.67																																																						
100+	\$45.55																																																						
PRICE																																																							
1-24	\$75.55																																																						
25-49	\$71.77																																																						
50-99	\$68.00																																																						
100+	\$64.97																																																						
PRICE																																																							
1-24	\$113.65																																																						
25-49	\$107.97																																																						
50-99	\$102.29																																																						
100+	\$97.74																																																						
PRICE																																																							
1-9	\$241.94																																																						
10-24	\$229.84																																																						
25-49	\$217.75																																																						
50+	\$208.07																																																						
2	 <table border="1"> <thead> <tr> <th colspan="2">PRICE</th> </tr> </thead> <tbody> <tr> <td>1-9</td> <td>\$259.16</td> </tr> <tr> <td>10-24</td> <td>\$246.20</td> </tr> <tr> <td>25-49</td> <td>\$233.24</td> </tr> <tr> <td>50+</td> <td>\$222.88</td> </tr> </tbody> </table> <p>N Female to LC Female</p> <p>Model No: PE9298</p>	PRICE		1-9	\$259.16	10-24	\$246.20	25-49	\$233.24	50+	\$222.88	 <table border="1"> <thead> <tr> <th colspan="2">PRICE</th> </tr> </thead> <tbody> <tr> <td>1-24</td> <td>\$101.72</td> </tr> <tr> <td>25-49</td> <td>\$97.65</td> </tr> <tr> <td>50-99</td> <td>\$94.60</td> </tr> <tr> <td>100+</td> <td>\$92.57</td> </tr> </tbody> </table> <p>N Female to MCX Plug</p> <p>Max. Freq. 6 GHz</p> <p>Model No: PE9463</p>	PRICE		1-24	\$101.72	25-49	\$97.65	50-99	\$94.60	100+	\$92.57	 <table border="1"> <thead> <tr> <th colspan="2">PRICE</th> </tr> </thead> <tbody> <tr> <td>1-9</td> <td>\$128.20</td> </tr> <tr> <td>10-24</td> <td>\$121.79</td> </tr> <tr> <td>25-49</td> <td>\$115.38</td> </tr> <tr> <td>50+</td> <td>\$110.25</td> </tr> </tbody> </table> <p>N Female to MCX Jack</p> <p>Max. Freq. 6 GHz</p> <p>Model No: PE9462</p>	PRICE		1-9	\$128.20	10-24	\$121.79	25-49	\$115.38	50+	\$110.25	 <table border="1"> <thead> <tr> <th colspan="2">PRICE</th> </tr> </thead> <tbody> <tr> <td>1-24</td> <td>\$25.89</td> </tr> <tr> <td>25-49</td> <td>\$24.60</td> </tr> <tr> <td>50-99</td> <td>\$23.30</td> </tr> <tr> <td>100+</td> <td>\$22.27</td> </tr> </tbody> </table> <p>N Female to Mini UHF Male</p> <p>VSWR 1.5:1 to 2.5 GHz</p> <p>Model No: PE9183</p>	PRICE		1-24	\$25.89	25-49	\$24.60	50-99	\$23.30	100+	\$22.27	 <table border="1"> <thead> <tr> <th colspan="2">PRICE</th> </tr> </thead> <tbody> <tr> <td>1-9</td> <td>\$109.68</td> </tr> <tr> <td>10-24</td> <td>\$104.20</td> </tr> <tr> <td>25-49</td> <td>\$98.71</td> </tr> <tr> <td>50+</td> <td>\$94.32</td> </tr> </tbody> </table> <p>N Female to SC Male</p> <p>Model No: PE9277</p>	PRICE		1-9	\$109.68	10-24	\$104.20	25-49	\$98.71	50+	\$94.32
	PRICE																																																						
1-9	\$259.16																																																						
10-24	\$246.20																																																						
25-49	\$233.24																																																						
50+	\$222.88																																																						
PRICE																																																							
1-24	\$101.72																																																						
25-49	\$97.65																																																						
50-99	\$94.60																																																						
100+	\$92.57																																																						
PRICE																																																							
1-9	\$128.20																																																						
10-24	\$121.79																																																						
25-49	\$115.38																																																						
50+	\$110.25																																																						
PRICE																																																							
1-24	\$25.89																																																						
25-49	\$24.60																																																						
50-99	\$23.30																																																						
100+	\$22.27																																																						
PRICE																																																							
1-9	\$109.68																																																						
10-24	\$104.20																																																						
25-49	\$98.71																																																						
50+	\$94.32																																																						
3	 <table border="1"> <thead> <tr> <th colspan="2">PRICE</th> </tr> </thead> <tbody> <tr> <td>1-9</td> <td>\$110.13</td> </tr> <tr> <td>10-24</td> <td>\$104.62</td> </tr> <tr> <td>25-49</td> <td>\$99.12</td> </tr> <tr> <td>50+</td> <td>\$94.71</td> </tr> </tbody> </table> <p>N Female to SC Female</p> <p>VSWR 1.25:1 to 11 GHz</p> <p>Model No: PE9292</p>	PRICE		1-9	\$110.13	10-24	\$104.62	25-49	\$99.12	50+	\$94.71	 <table border="1"> <thead> <tr> <th colspan="2">PRICE</th> </tr> </thead> <tbody> <tr> <td>1-24</td> <td>\$52.30</td> </tr> <tr> <td>25-49</td> <td>\$49.69</td> </tr> <tr> <td>50-99</td> <td>\$47.07</td> </tr> <tr> <td>100+</td> <td>\$44.98</td> </tr> </tbody> </table> <p>Low PIM</p> <p>N Female to SMA Male</p> <p>VSWR 1.2:1 to 6 GHz</p> <p>Model No: PE91178</p>	PRICE		1-24	\$52.30	25-49	\$49.69	50-99	\$47.07	100+	\$44.98	 <table border="1"> <thead> <tr> <th colspan="2">PRICE</th> </tr> </thead> <tbody> <tr> <td>1-24</td> <td>\$71.18</td> </tr> <tr> <td>25-49</td> <td>\$67.62</td> </tr> <tr> <td>50-99</td> <td>\$64.06</td> </tr> <tr> <td>100+</td> <td>\$61.21</td> </tr> </tbody> </table> <p>N Female to SMB Plug</p> <p>Model No: PE9316</p>	PRICE		1-24	\$71.18	25-49	\$67.62	50-99	\$64.06	100+	\$61.21	 <table border="1"> <thead> <tr> <th colspan="2">PRICE</th> </tr> </thead> <tbody> <tr> <td>1-24</td> <td>\$71.18</td> </tr> <tr> <td>25-49</td> <td>\$67.62</td> </tr> <tr> <td>50-99</td> <td>\$64.06</td> </tr> <tr> <td>100+</td> <td>\$61.21</td> </tr> </tbody> </table> <p>N Female to SMB Jack</p> <p>Model No: PE9315</p>	PRICE		1-24	\$71.18	25-49	\$67.62	50-99	\$64.06	100+	\$61.21	 <table border="1"> <thead> <tr> <th colspan="2">PRICE</th> </tr> </thead> <tbody> <tr> <td>1-24</td> <td>\$103.17</td> </tr> <tr> <td>25-49</td> <td>\$98.01</td> </tr> <tr> <td>50-99</td> <td>\$92.85</td> </tr> <tr> <td>100+</td> <td>\$88.73</td> </tr> </tbody> </table> <p>N Female to SMC Plug</p> <p>Model No: PE9320</p>	PRICE		1-24	\$103.17	25-49	\$98.01	50-99	\$92.85	100+	\$88.73
	PRICE																																																						
1-9	\$110.13																																																						
10-24	\$104.62																																																						
25-49	\$99.12																																																						
50+	\$94.71																																																						
PRICE																																																							
1-24	\$52.30																																																						
25-49	\$49.69																																																						
50-99	\$47.07																																																						
100+	\$44.98																																																						
PRICE																																																							
1-24	\$71.18																																																						
25-49	\$67.62																																																						
50-99	\$64.06																																																						
100+	\$61.21																																																						
PRICE																																																							
1-24	\$71.18																																																						
25-49	\$67.62																																																						
50-99	\$64.06																																																						
100+	\$61.21																																																						
PRICE																																																							
1-24	\$103.17																																																						
25-49	\$98.01																																																						
50-99	\$92.85																																																						
100+	\$88.73																																																						
4	 <table border="1"> <thead> <tr> <th colspan="2">PRICE</th> </tr> </thead> <tbody> <tr> <td>1-24</td> <td>\$82.59</td> </tr> <tr> <td>25-49</td> <td>\$78.46</td> </tr> <tr> <td>50-99</td> <td>\$74.33</td> </tr> <tr> <td>100+</td> <td>\$71.03</td> </tr> </tbody> </table> <p>N Female to SMC Jack</p> <p>Model No: PE9319</p>	PRICE		1-24	\$82.59	25-49	\$78.46	50-99	\$74.33	100+	\$71.03	 <table border="1"> <thead> <tr> <th colspan="2">PRICE</th> </tr> </thead> <tbody> <tr> <td>1-24</td> <td>\$21.40</td> </tr> <tr> <td>25-49</td> <td>\$20.33</td> </tr> <tr> <td>50-99</td> <td>\$19.26</td> </tr> <tr> <td>100+</td> <td>\$18.40</td> </tr> </tbody> </table> <p>N Female to TNC Male</p> <p>VSWR 1.3:1 to 6 GHz</p> <p>Model No: PE9089</p>	PRICE		1-24	\$21.40	25-49	\$20.33	50-99	\$19.26	100+	\$18.40	 <table border="1"> <thead> <tr> <th colspan="2">PRICE</th> </tr> </thead> <tbody> <tr> <td>1-24</td> <td>\$139.01</td> </tr> <tr> <td>25-49</td> <td>\$129.28</td> </tr> <tr> <td>50-99</td> <td>\$119.55</td> </tr> <tr> <td>100+</td> <td>\$111.21</td> </tr> </tbody> </table> <p>PRECISION</p> <p>N Female to TNC Male</p> <p>VSWR 1.2:1 to 18 GHz</p> <p>Model No: PE91506</p>	PRICE		1-24	\$139.01	25-49	\$129.28	50-99	\$119.55	100+	\$111.21	 <table border="1"> <thead> <tr> <th colspan="2">PRICE</th> </tr> </thead> <tbody> <tr> <td>1-24</td> <td>\$63.98</td> </tr> <tr> <td>25-49</td> <td>\$60.78</td> </tr> <tr> <td>50-99</td> <td>\$57.58</td> </tr> <tr> <td>100+</td> <td>\$55.02</td> </tr> </tbody> </table> <p>N Female to TNC Male Right Angle</p> <p>VSWR 1.5:1 to 6 GHz</p> <p>Model No: PE9263</p>	PRICE		1-24	\$63.98	25-49	\$60.78	50-99	\$57.58	100+	\$55.02	 <table border="1"> <thead> <tr> <th colspan="2">PRICE</th> </tr> </thead> <tbody> <tr> <td>1-24</td> <td>\$25.83</td> </tr> <tr> <td>25-49</td> <td>\$24.54</td> </tr> <tr> <td>50-99</td> <td>\$23.25</td> </tr> <tr> <td>100+</td> <td>\$22.21</td> </tr> </tbody> </table> <p>N Female to TNC Female</p> <p>VSWR 1.5:1 to 3 GHz</p> <p>Model No: PE9131</p>	PRICE		1-24	\$25.83	25-49	\$24.54	50-99	\$23.25	100+	\$22.21
	PRICE																																																						
1-24	\$82.59																																																						
25-49	\$78.46																																																						
50-99	\$74.33																																																						
100+	\$71.03																																																						
PRICE																																																							
1-24	\$21.40																																																						
25-49	\$20.33																																																						
50-99	\$19.26																																																						
100+	\$18.40																																																						
PRICE																																																							
1-24	\$139.01																																																						
25-49	\$129.28																																																						
50-99	\$119.55																																																						
100+	\$111.21																																																						
PRICE																																																							
1-24	\$63.98																																																						
25-49	\$60.78																																																						
50-99	\$57.58																																																						
100+	\$55.02																																																						
PRICE																																																							
1-24	\$25.83																																																						
25-49	\$24.54																																																						
50-99	\$23.25																																																						
100+	\$22.21																																																						
5	 <table border="1"> <thead> <tr> <th colspan="2">PRICE</th> </tr> </thead> <tbody> <tr> <td>1-9</td> <td>\$186.29</td> </tr> <tr> <td>10-24</td> <td>\$176.98</td> </tr> <tr> <td>25-49</td> <td>\$167.66</td> </tr> <tr> <td>50+</td> <td>\$160.21</td> </tr> </tbody> </table> <p>PRECISION</p> <p>N Female to TNC Female</p> <p>VSWR 1.15:1 to 18 GHz</p> <p>Model No: PE9449</p>	PRICE		1-9	\$186.29	10-24	\$176.98	25-49	\$167.66	50+	\$160.21	 <table border="1"> <thead> <tr> <th colspan="2">PRICE</th> </tr> </thead> <tbody> <tr> <td>1-24</td> <td>\$87.30</td> </tr> <tr> <td>25-49</td> <td>\$82.94</td> </tr> <tr> <td>50-99</td> <td>\$78.57</td> </tr> <tr> <td>100+</td> <td>\$75.08</td> </tr> </tbody> </table> <p>N Female to TNC Female 4 Hole Flange-Mounting Hole A05</p> <p>Model No: PE9552</p>	PRICE		1-24	\$87.30	25-49	\$82.94	50-99	\$78.57	100+	\$75.08	 <table border="1"> <thead> <tr> <th colspan="2">PRICE</th> </tr> </thead> <tbody> <tr> <td>1-24</td> <td>\$49.21</td> </tr> <tr> <td>25-49</td> <td>\$46.75</td> </tr> <tr> <td>50-99</td> <td>\$44.29</td> </tr> <tr> <td>100+</td> <td>\$42.32</td> </tr> </tbody> </table> <p>N Female to TNC Female Bulkhead</p> <p>VSWR 1.35:1 to 10 GHz</p> <p>Model No: PE9482</p>	PRICE		1-24	\$49.21	25-49	\$46.75	50-99	\$44.29	100+	\$42.32	 <table border="1"> <thead> <tr> <th colspan="2">PRICE</th> </tr> </thead> <tbody> <tr> <td>1-9</td> <td>\$147.89</td> </tr> <tr> <td>10-24</td> <td>\$140.50</td> </tr> <tr> <td>25-49</td> <td>\$133.10</td> </tr> <tr> <td>50+</td> <td>\$127.19</td> </tr> </tbody> </table> <p>PRECISION</p> <p>N Female to TNC Female 4 Hole Flange-Mounting Hole A05</p> <p>VSWR 1.15:1 to 18 GHz</p> <p>Model No: PE9450</p>	PRICE		1-9	\$147.89	10-24	\$140.50	25-49	\$133.10	50+	\$127.19	 <table border="1"> <thead> <tr> <th colspan="2">PRICE</th> </tr> </thead> <tbody> <tr> <td>1-24</td> <td>\$31.14</td> </tr> <tr> <td>25-49</td> <td>\$29.58</td> </tr> <tr> <td>50-99</td> <td>\$28.03</td> </tr> <tr> <td>100+</td> <td>\$26.78</td> </tr> </tbody> </table> <p>N Female to UHF Male</p> <p>VSWR 1.3:1 to 300 MHz</p> <p>Model No: PE9112</p>	PRICE		1-24	\$31.14	25-49	\$29.58	50-99	\$28.03	100+	\$26.78
	PRICE																																																						
1-9	\$186.29																																																						
10-24	\$176.98																																																						
25-49	\$167.66																																																						
50+	\$160.21																																																						
PRICE																																																							
1-24	\$87.30																																																						
25-49	\$82.94																																																						
50-99	\$78.57																																																						
100+	\$75.08																																																						
PRICE																																																							
1-24	\$49.21																																																						
25-49	\$46.75																																																						
50-99	\$44.29																																																						
100+	\$42.32																																																						
PRICE																																																							
1-9	\$147.89																																																						
10-24	\$140.50																																																						
25-49	\$133.10																																																						
50+	\$127.19																																																						
PRICE																																																							
1-24	\$31.14																																																						
25-49	\$29.58																																																						
50-99	\$28.03																																																						
100+	\$26.78																																																						
6	 <table border="1"> <thead> <tr> <th colspan="2">PRICE</th> </tr> </thead> <tbody> <tr> <td>1-24</td> <td>\$37.07</td> </tr> <tr> <td>25-49</td> <td>\$35.22</td> </tr> <tr> <td>50-99</td> <td>\$33.36</td> </tr> <tr> <td>100+</td> <td>\$31.88</td> </tr> </tbody> </table> <p>N Female to UHF Female</p> <p>Max. Freq. 1,000 MHz</p> <p>Model No: PE9385</p>	PRICE		1-24	\$37.07	25-49	\$35.22	50-99	\$33.36	100+	\$31.88	<p>Reverse Polarity N Between Series</p> <p>→</p>		 <table border="1"> <thead> <tr> <th colspan="2">PRICE</th> </tr> </thead> <tbody> <tr> <td>1-24</td> <td>\$47.23</td> </tr> <tr> <td>25-49</td> <td>\$44.87</td> </tr> <tr> <td>50-99</td> <td>\$42.51</td> </tr> <tr> <td>100+</td> <td>\$40.62</td> </tr> </tbody> </table> <p>N Male to Rev. Pol. TNC Female</p> <p>VSWR 1.3:1 to 6 GHz</p> <p>Model No: PE9730</p>	PRICE		1-24	\$47.23	25-49	\$44.87	50-99	\$42.51	100+	\$40.62	 <table border="1"> <thead> <tr> <th colspan="2">PRICE</th> </tr> </thead> <tbody> <tr> <td>1-24</td> <td>\$47.06</td> </tr> <tr> <td>25-49</td> <td>\$44.71</td> </tr> <tr> <td>50-99</td> <td>\$42.35</td> </tr> <tr> <td>100+</td> <td>\$40.47</td> </tr> </tbody> </table> <p>N Female to Rev. Pol. TNC Male</p> <p>Model No: PE9731</p>	PRICE		1-24	\$47.06	25-49	\$44.71	50-99	\$42.35	100+	\$40.47																				
	PRICE																																																						
1-24	\$37.07																																																						
25-49	\$35.22																																																						
50-99	\$33.36																																																						
100+	\$31.88																																																						
PRICE																																																							
1-24	\$47.23																																																						
25-49	\$44.87																																																						
50-99	\$42.51																																																						
100+	\$40.62																																																						
PRICE																																																							
1-24	\$47.06																																																						
25-49	\$44.71																																																						
50-99	\$42.35																																																						
100+	\$40.47																																																						
7	 <table border="1"> <thead> <tr> <th colspan="2">PRICE</th> </tr> </thead> <tbody> <tr> <td>1-24</td> <td>\$55.22</td> </tr> <tr> <td>25-49</td> <td>\$52.46</td> </tr> <tr> <td>50-99</td> <td>\$49.70</td> </tr> <tr> <td>100+</td> <td>\$47.49</td> </tr> </tbody> </table> <p>Snap-On QMA Male to Snap-On QMA Male</p> <p>VSWR 1.08:1 to 6 GHz</p> <p>Model No: PE91341</p>	PRICE		1-24	\$55.22	25-49	\$52.46	50-99	\$49.70	100+	\$47.49	 <table border="1"> <thead> <tr> <th colspan="2">PRICE</th> </tr> </thead> <tbody> <tr> <td>1-24</td> <td>\$33.20</td> </tr> <tr> <td>25-49</td> <td>\$31.54</td> </tr> <tr> <td>50-99</td> <td>\$29.88</td> </tr> <tr> <td>100+</td> <td>\$28.55</td> </tr> </tbody> </table> <p>Snap-On QMA Male to Snap-On QMA Female</p> <p>VSWR 1.12:1 to 6 GHz</p> <p>Model No: PE91342</p>	PRICE		1-24	\$33.20	25-49	\$31.54	50-99	\$29.88	100+	\$28.55	 <table border="1"> <thead> <tr> <th colspan="2">PRICE</th> </tr> </thead> <tbody> <tr> <td>1-9</td> <td>\$162.74</td> </tr> <tr> <td>10-24</td> <td>\$154.60</td> </tr> <tr> <td>25-49</td> <td>\$146.47</td> </tr> <tr> <td>NEW 50+</td> <td>\$139.96</td> </tr> </tbody> </table> <p>Snap-On QMA Female to Snap-On QMA Female</p> <p>VSWR 1.08:1 to 6 GHz</p> <p>Model No: PE91343</p>	PRICE		1-9	\$162.74	10-24	\$154.60	25-49	\$146.47	NEW 50+	\$139.96	<p>QMA Between Series</p> <p>→</p>		 <table border="1"> <thead> <tr> <th colspan="2">PRICE</th> </tr> </thead> <tbody> <tr> <td>1-9</td> <td>\$179.20</td> </tr> <tr> <td>10-24</td> <td>\$170.24</td> </tr> <tr> <td>25-49</td> <td>\$161.28</td> </tr> <tr> <td>50+</td> <td>\$154.11</td> </tr> </tbody> </table> <p>Snap-On QMA Male to Snap-On SMA Male</p> <p>VSWR 1.18:1 to 6 GHz</p> <p>Model No: PE91344</p>	PRICE		1-9	\$179.20	10-24	\$170.24	25-49	\$161.28	50+	\$154.11									
	PRICE																																																						
1-24	\$55.22																																																						
25-49	\$52.46																																																						
50-99	\$49.70																																																						
100+	\$47.49																																																						
PRICE																																																							
1-24	\$33.20																																																						
25-49	\$31.54																																																						
50-99	\$29.88																																																						
100+	\$28.55																																																						
PRICE																																																							
1-9	\$162.74																																																						
10-24	\$154.60																																																						
25-49	\$146.47																																																						
NEW 50+	\$139.96																																																						
PRICE																																																							
1-9	\$179.20																																																						
10-24	\$170.24																																																						
25-49	\$161.28																																																						
50+	\$154.11																																																						

ADAPTERS

See Adapter Locator on Pages 8-13

See Page 369 for Mounting Holes

	A	B	C	D	E																																													
1	 <table border="1"> <thead> <tr><th>PRICE</th></tr> </thead> <tbody> <tr><td>1-24</td><td>\$63.66</td></tr> <tr><td>25-49</td><td>\$60.48</td></tr> <tr><td>50-99</td><td>\$57.29</td></tr> <tr><td>NEW 100+</td><td>\$54.75</td></tr> </tbody> </table> <p>Snap-On QMA Male to SMA Female VSWR 1.18:1 to 6 GHz Model No: PE91345</p>	PRICE	1-24	\$63.66	25-49	\$60.48	50-99	\$57.29	NEW 100+	\$54.75	 <table border="1"> <thead> <tr><th>PRICE</th></tr> </thead> <tbody> <tr><td>1-24</td><td>\$51.11</td></tr> <tr><td>25-49</td><td>\$48.55</td></tr> <tr><td>50-99</td><td>\$46.00</td></tr> <tr><td>NEW 100+</td><td>\$43.95</td></tr> </tbody> </table> <p>Snap-On QMA Female to SMA Male VSWR 1.18:1 to 6 GHz Model No: PE91346</p>	PRICE	1-24	\$51.11	25-49	\$48.55	50-99	\$46.00	NEW 100+	\$43.95	 <table border="1"> <thead> <tr><th>PRICE</th></tr> </thead> <tbody> <tr><td>1-9</td><td>\$109.94</td></tr> <tr><td>10-24</td><td>\$104.44</td></tr> <tr><td>25-49</td><td>\$98.95</td></tr> <tr><td>NEW 50+</td><td>\$94.55</td></tr> </tbody> </table> <p>Snap-On QMA Female to Snap-On SMA Female VSWR 1.18:1 to 6 GHz Model No: PE91347</p>	PRICE	1-9	\$109.94	10-24	\$104.44	25-49	\$98.95	NEW 50+	\$94.55	<p style="text-align: center;">SC In-Series</p> <p style="text-align: center;">→</p>	 <table border="1"> <thead> <tr><th>PRICE</th></tr> </thead> <tbody> <tr><td>1-9</td><td>\$112.00</td></tr> <tr><td>10-24</td><td>\$106.40</td></tr> <tr><td>25-49</td><td>\$100.80</td></tr> <tr><td>50+</td><td>\$96.32</td></tr> </tbody> </table> <p>SC Male to SC Male Model No: PE9403</p>	PRICE	1-9	\$112.00	10-24	\$106.40	25-49	\$100.80	50+	\$96.32									
	PRICE																																																	
1-24	\$63.66																																																	
25-49	\$60.48																																																	
50-99	\$57.29																																																	
NEW 100+	\$54.75																																																	
PRICE																																																		
1-24	\$51.11																																																	
25-49	\$48.55																																																	
50-99	\$46.00																																																	
NEW 100+	\$43.95																																																	
PRICE																																																		
1-9	\$109.94																																																	
10-24	\$104.44																																																	
25-49	\$98.95																																																	
NEW 50+	\$94.55																																																	
PRICE																																																		
1-9	\$112.00																																																	
10-24	\$106.40																																																	
25-49	\$100.80																																																	
50+	\$96.32																																																	
2	 <table border="1"> <thead> <tr><th>PRICE</th></tr> </thead> <tbody> <tr><td>1-24</td><td>\$82.33</td></tr> <tr><td>25-49</td><td>\$78.21</td></tr> <tr><td>50-99</td><td>\$74.10</td></tr> <tr><td>100+</td><td>\$70.80</td></tr> </tbody> </table> <p>SC Male to SC Female Model No: PE9572</p>	PRICE	1-24	\$82.33	25-49	\$78.21	50-99	\$74.10	100+	\$70.80	 <table border="1"> <thead> <tr><th>PRICE</th></tr> </thead> <tbody> <tr><td>1-9</td><td>\$162.12</td></tr> <tr><td>10-24</td><td>\$154.01</td></tr> <tr><td>25-49</td><td>\$145.91</td></tr> <tr><td>50+</td><td>\$139.42</td></tr> </tbody> </table> <p>SC Male to SC Female Right Angle Model No: PE9405</p>	PRICE	1-9	\$162.12	10-24	\$154.01	25-49	\$145.91	50+	\$139.42	 <table border="1"> <thead> <tr><th>PRICE</th></tr> </thead> <tbody> <tr><td>1-9</td><td>\$266.89</td></tr> <tr><td>10-24</td><td>\$253.55</td></tr> <tr><td>25-49</td><td>\$240.20</td></tr> <tr><td>50+</td><td>\$229.53</td></tr> </tbody> </table> <p>SC Female to SC Male Tee Model No: PE9225</p>	PRICE	1-9	\$266.89	10-24	\$253.55	25-49	\$240.20	50+	\$229.53	 <table border="1"> <thead> <tr><th>PRICE</th></tr> </thead> <tbody> <tr><td>1-9</td><td>\$117.84</td></tr> <tr><td>10-24</td><td>\$111.95</td></tr> <tr><td>25-49</td><td>\$106.06</td></tr> <tr><td>50+</td><td>\$101.34</td></tr> </tbody> </table> <p>SC Female to SC Female Model No: PE9404</p>	PRICE	1-9	\$117.84	10-24	\$111.95	25-49	\$106.06	50+	\$101.34	 <table border="1"> <thead> <tr><th>PRICE</th></tr> </thead> <tbody> <tr><td>1-9</td><td>\$151.55</td></tr> <tr><td>10-24</td><td>\$143.97</td></tr> <tr><td>25-49</td><td>\$136.40</td></tr> <tr><td>50+</td><td>\$130.33</td></tr> </tbody> </table> <p>SC Female to SC Female Bulkhead Model No: PE9573</p>	PRICE	1-9	\$151.55	10-24	\$143.97	25-49	\$136.40	50+	\$130.33
	PRICE																																																	
1-24	\$82.33																																																	
25-49	\$78.21																																																	
50-99	\$74.10																																																	
100+	\$70.80																																																	
PRICE																																																		
1-9	\$162.12																																																	
10-24	\$154.01																																																	
25-49	\$145.91																																																	
50+	\$139.42																																																	
PRICE																																																		
1-9	\$266.89																																																	
10-24	\$253.55																																																	
25-49	\$240.20																																																	
50+	\$229.53																																																	
PRICE																																																		
1-9	\$117.84																																																	
10-24	\$111.95																																																	
25-49	\$106.06																																																	
50+	\$101.34																																																	
PRICE																																																		
1-9	\$151.55																																																	
10-24	\$143.97																																																	
25-49	\$136.40																																																	
50+	\$130.33																																																	
3	<p style="text-align: center;">SC Between Series</p> <p style="text-align: center;">→</p>	 <table border="1"> <thead> <tr><th>PRICE</th></tr> </thead> <tbody> <tr><td>1-24</td><td>\$55.48</td></tr> <tr><td>25-49</td><td>\$52.71</td></tr> <tr><td>50-99</td><td>\$49.93</td></tr> <tr><td>100+</td><td>\$47.71</td></tr> </tbody> </table> <p>SC Male to BNC Male Model No: PE9568</p>	PRICE	1-24	\$55.48	25-49	\$52.71	50-99	\$49.93	100+	\$47.71	 <table border="1"> <thead> <tr><th>PRICE</th></tr> </thead> <tbody> <tr><td>1-9</td><td>\$191.22</td></tr> <tr><td>10-24</td><td>\$181.66</td></tr> <tr><td>25-49</td><td>\$172.10</td></tr> <tr><td>50+</td><td>\$164.45</td></tr> </tbody> </table> <p>SC Male to BNC Female Model No: PE9200</p>	PRICE	1-9	\$191.22	10-24	\$181.66	25-49	\$172.10	50+	\$164.45	 <table border="1"> <thead> <tr><th>PRICE</th></tr> </thead> <tbody> <tr><td>1-24</td><td>\$74.47</td></tr> <tr><td>25-49</td><td>\$70.75</td></tr> <tr><td>50-99</td><td>\$67.02</td></tr> <tr><td>100+</td><td>\$64.04</td></tr> </tbody> </table> <p>SC Female to BNC Female Model No: PE9571</p>	PRICE	1-24	\$74.47	25-49	\$70.75	50-99	\$67.02	100+	\$64.04	<p style="text-align: center;">SHV In-Series</p> <p style="text-align: center;">→</p>																		
		PRICE																																																
1-24	\$55.48																																																	
25-49	\$52.71																																																	
50-99	\$49.93																																																	
100+	\$47.71																																																	
PRICE																																																		
1-9	\$191.22																																																	
10-24	\$181.66																																																	
25-49	\$172.10																																																	
50+	\$164.45																																																	
PRICE																																																		
1-24	\$74.47																																																	
25-49	\$70.75																																																	
50-99	\$67.02																																																	
100+	\$64.04																																																	
4	 <table border="1"> <thead> <tr><th>PRICE</th></tr> </thead> <tbody> <tr><td>1-9</td><td>\$127.63</td></tr> <tr><td>10-24</td><td>\$121.25</td></tr> <tr><td>25-49</td><td>\$114.87</td></tr> <tr><td>50+</td><td>\$109.76</td></tr> </tbody> </table> <p>SHV Plug to SHV Jack Model No: PE9749</p>	PRICE	1-9	\$127.63	10-24	\$121.25	25-49	\$114.87	50+	\$109.76	 <table border="1"> <thead> <tr><th>PRICE</th></tr> </thead> <tbody> <tr><td>1-24</td><td>\$88.28</td></tr> <tr><td>25-49</td><td>\$83.87</td></tr> <tr><td>50-99</td><td>\$79.45</td></tr> <tr><td>100+</td><td>\$75.92</td></tr> </tbody> </table> <p>SHV Plug to SHV Jack Right Angle Model No: PE9338</p>	PRICE	1-24	\$88.28	25-49	\$83.87	50-99	\$79.45	100+	\$75.92	 <table border="1"> <thead> <tr><th>PRICE</th></tr> </thead> <tbody> <tr><td>1-24</td><td>\$102.79</td></tr> <tr><td>25-49</td><td>\$97.65</td></tr> <tr><td>50-99</td><td>\$92.51</td></tr> <tr><td>100+</td><td>\$88.40</td></tr> </tbody> </table> <p>SHV Jack to SHV Plug Tee VSWR 1.2:1 to 300 MHz Model No: PE9249</p>	PRICE	1-24	\$102.79	25-49	\$97.65	50-99	\$92.51	100+	\$88.40	 <table border="1"> <thead> <tr><th>PRICE</th></tr> </thead> <tbody> <tr><td>1-24</td><td>\$44.83</td></tr> <tr><td>25-49</td><td>\$42.59</td></tr> <tr><td>50-99</td><td>\$40.35</td></tr> <tr><td>100+</td><td>\$38.55</td></tr> </tbody> </table> <p>SHV Jack to SHV Jack VSWR 1.3:1 to 300 MHz Model No: PE9337</p>	PRICE	1-24	\$44.83	25-49	\$42.59	50-99	\$40.35	100+	\$38.55	 <table border="1"> <thead> <tr><th>PRICE</th></tr> </thead> <tbody> <tr><td>1-24</td><td>\$88.25</td></tr> <tr><td>25-49</td><td>\$83.84</td></tr> <tr><td>50-99</td><td>\$79.43</td></tr> <tr><td>100+</td><td>\$75.90</td></tr> </tbody> </table> <p>SHV Jack to SHV Jack Bulkhead Max. Freq. 300 MHz Model No: PE9336</p>	PRICE	1-24	\$88.25	25-49	\$83.84	50-99	\$79.43	100+	\$75.90
	PRICE																																																	
1-9	\$127.63																																																	
10-24	\$121.25																																																	
25-49	\$114.87																																																	
50+	\$109.76																																																	
PRICE																																																		
1-24	\$88.28																																																	
25-49	\$83.87																																																	
50-99	\$79.45																																																	
100+	\$75.92																																																	
PRICE																																																		
1-24	\$102.79																																																	
25-49	\$97.65																																																	
50-99	\$92.51																																																	
100+	\$88.40																																																	
PRICE																																																		
1-24	\$44.83																																																	
25-49	\$42.59																																																	
50-99	\$40.35																																																	
100+	\$38.55																																																	
PRICE																																																		
1-24	\$88.25																																																	
25-49	\$83.84																																																	
50-99	\$79.43																																																	
100+	\$75.90																																																	
5	<p style="text-align: center;">SMA In-Series</p> <p style="text-align: center;">→</p>	 <table border="1"> <thead> <tr><th>PRICE</th></tr> </thead> <tbody> <tr><td>1-24</td><td>\$19.29</td></tr> <tr><td>25-49</td><td>\$18.33</td></tr> <tr><td>50-99</td><td>\$17.36</td></tr> <tr><td>100+</td><td>\$16.59</td></tr> </tbody> </table> <p>SMA Male to SMA Male VSWR 1.23:1 to 18 GHz Model No: PE91135</p>	PRICE	1-24	\$19.29	25-49	\$18.33	50-99	\$17.36	100+	\$16.59	 <table border="1"> <thead> <tr><th>PRICE</th></tr> </thead> <tbody> <tr><td>1-24</td><td>\$72.63</td></tr> <tr><td>25-49</td><td>\$69.00</td></tr> <tr><td>50-99</td><td>\$65.37</td></tr> <tr><td>PRECISION 100+</td><td>\$62.46</td></tr> </tbody> </table> <p>SMA Male to SMA Male VSWR 1.2:1 to 27 GHz Model No: PE9505</p>	PRICE	1-24	\$72.63	25-49	\$69.00	50-99	\$65.37	PRECISION 100+	\$62.46	 <table border="1"> <thead> <tr><th>PRICE</th></tr> </thead> <tbody> <tr><td>1-9</td><td>Call</td></tr> <tr><td>10-24</td><td>Call</td></tr> <tr><td>25-49</td><td>Call</td></tr> <tr><td>50+</td><td>Call</td></tr> </tbody> </table> <p>SMA Male to SMA Male Radius Right Angle VSWR 1.25:1 to 18 GHz Model No: PE91327</p>	PRICE	1-9	Call	10-24	Call	25-49	Call	50+	Call	 <table border="1"> <thead> <tr><th>PRICE</th></tr> </thead> <tbody> <tr><td>1-9</td><td>Call</td></tr> <tr><td>10-24</td><td>Call</td></tr> <tr><td>25-49</td><td>Call</td></tr> <tr><td>PRECISION NEW 50+</td><td>Call</td></tr> </tbody> </table> <p>SMA Male to SMA Male Radius Right Angle VSWR 1.25:1 to 18 GHz Model No: PE91458</p>	PRICE	1-9	Call	10-24	Call	25-49	Call	PRECISION NEW 50+	Call									
		PRICE																																																
1-24	\$19.29																																																	
25-49	\$18.33																																																	
50-99	\$17.36																																																	
100+	\$16.59																																																	
PRICE																																																		
1-24	\$72.63																																																	
25-49	\$69.00																																																	
50-99	\$65.37																																																	
PRECISION 100+	\$62.46																																																	
PRICE																																																		
1-9	Call																																																	
10-24	Call																																																	
25-49	Call																																																	
50+	Call																																																	
PRICE																																																		
1-9	Call																																																	
10-24	Call																																																	
25-49	Call																																																	
PRECISION NEW 50+	Call																																																	
6	 <table border="1"> <thead> <tr><th>PRICE</th></tr> </thead> <tbody> <tr><td>1-24</td><td>\$53.31</td></tr> <tr><td>25-49</td><td>\$50.64</td></tr> <tr><td>50-99</td><td>\$47.98</td></tr> <tr><td>100+</td><td>\$45.85</td></tr> </tbody> </table> <p>SMA Male to SMA Male Right Angle VSWR 1.5:1 to 12.4 GHz Model No: PE9418</p>	PRICE	1-24	\$53.31	25-49	\$50.64	50-99	\$47.98	100+	\$45.85	 <table border="1"> <thead> <tr><th>PRICE</th></tr> </thead> <tbody> <tr><td>1-24</td><td>\$76.60</td></tr> <tr><td>25-49</td><td>\$72.77</td></tr> <tr><td>50-99</td><td>\$68.94</td></tr> <tr><td>100+</td><td>\$65.88</td></tr> </tbody> </table> <p>SMA Male to SMA Male Tee Model No: PE9379</p>	PRICE	1-24	\$76.60	25-49	\$72.77	50-99	\$68.94	100+	\$65.88	 <table border="1"> <thead> <tr><th>PRICE</th></tr> </thead> <tbody> <tr><td>1-24</td><td>\$100.21</td></tr> <tr><td>25-49</td><td>\$95.20</td></tr> <tr><td>50-99</td><td>\$90.19</td></tr> <tr><td>PRECISION 100+</td><td>\$86.18</td></tr> </tbody> </table> <p>SMA Male to SMA Male Miter Right Angle VSWR 1.15:1 to 27 GHz Model No: PE91151</p>	PRICE	1-24	\$100.21	25-49	\$95.20	50-99	\$90.19	PRECISION 100+	\$86.18	 <table border="1"> <thead> <tr><th>PRICE</th></tr> </thead> <tbody> <tr><td>1-24</td><td>\$94.56</td></tr> <tr><td>25-49</td><td>\$89.83</td></tr> <tr><td>50-99</td><td>\$85.10</td></tr> <tr><td>100+</td><td>\$81.32</td></tr> </tbody> </table> <p>SMA Male to SMA Male Miter Right Angle VSWR 1.35:1 to 27 GHz Model No: PE9642</p>	PRICE	1-24	\$94.56	25-49	\$89.83	50-99	\$85.10	100+	\$81.32	 <table border="1"> <thead> <tr><th>PRICE</th></tr> </thead> <tbody> <tr><td>1-9</td><td>\$218.37</td></tr> <tr><td>10-24</td><td>\$209.64</td></tr> <tr><td>25-49</td><td>\$203.08</td></tr> <tr><td>50+</td><td>\$198.72</td></tr> </tbody> </table> <p>SMA Male to SMA Male 4 Hole Flange-Mounting Hole A01 VSWR 1.2:1 to 18 GHz Model No: PE9669</p>	PRICE	1-9	\$218.37	10-24	\$209.64	25-49	\$203.08	50+	\$198.72
	PRICE																																																	
1-24	\$53.31																																																	
25-49	\$50.64																																																	
50-99	\$47.98																																																	
100+	\$45.85																																																	
PRICE																																																		
1-24	\$76.60																																																	
25-49	\$72.77																																																	
50-99	\$68.94																																																	
100+	\$65.88																																																	
PRICE																																																		
1-24	\$100.21																																																	
25-49	\$95.20																																																	
50-99	\$90.19																																																	
PRECISION 100+	\$86.18																																																	
PRICE																																																		
1-24	\$94.56																																																	
25-49	\$89.83																																																	
50-99	\$85.10																																																	
100+	\$81.32																																																	
PRICE																																																		
1-9	\$218.37																																																	
10-24	\$209.64																																																	
25-49	\$203.08																																																	
50+	\$198.72																																																	
7	 <table border="1"> <thead> <tr><th>PRICE</th></tr> </thead> <tbody> <tr><td>1-24</td><td>\$26.94</td></tr> <tr><td>25-49</td><td>\$25.59</td></tr> <tr><td>50-99</td><td>\$24.25</td></tr> <tr><td>100+</td><td>\$23.17</td></tr> </tbody> </table> <p>SMA Male to SMA Female VSWR 1.25:1 to 18 GHz Model No: PE9103</p>	PRICE	1-24	\$26.94	25-49	\$25.59	50-99	\$24.25	100+	\$23.17	 <table border="1"> <thead> <tr><th>PRICE</th></tr> </thead> <tbody> <tr><td>1-24</td><td>\$31.40</td></tr> <tr><td>25-49</td><td>\$29.83</td></tr> <tr><td>50-99</td><td>\$28.26</td></tr> <tr><td>100+</td><td>\$27.00</td></tr> </tbody> </table> <p>QD SMA Male to SMA Female Model No: PE9546</p>	PRICE	1-24	\$31.40	25-49	\$29.83	50-99	\$28.26	100+	\$27.00	 <table border="1"> <thead> <tr><th>PRICE</th></tr> </thead> <tbody> <tr><td>1-24</td><td>\$52.31</td></tr> <tr><td>25-49</td><td>\$49.69</td></tr> <tr><td>50-99</td><td>\$47.08</td></tr> <tr><td>PRECISION 100+</td><td>\$44.99</td></tr> </tbody> </table> <p>SMA Male to SMA Female VSWR 1.2:1 to 18 GHz Model No: PE9694</p>	PRICE	1-24	\$52.31	25-49	\$49.69	50-99	\$47.08	PRECISION 100+	\$44.99	 <table border="1"> <thead> <tr><th>PRICE</th></tr> </thead> <tbody> <tr><td>1-9</td><td>\$149.17</td></tr> <tr><td>10-24</td><td>\$141.71</td></tr> <tr><td>25-49</td><td>\$134.25</td></tr> <tr><td>PRECISION 50+</td><td>\$128.29</td></tr> </tbody> </table> <p>QD SMA Male to SMA Female VSWR 1.14:1 to 18 GHz Model No: PE9774</p>	PRICE	1-9	\$149.17	10-24	\$141.71	25-49	\$134.25	PRECISION 50+	\$128.29	 <table border="1"> <thead> <tr><th>PRICE</th></tr> </thead> <tbody> <tr><td>1-24</td><td>\$58.00</td></tr> <tr><td>25-49</td><td>\$53.94</td></tr> <tr><td>50-99</td><td>\$49.88</td></tr> <tr><td>100+</td><td>\$46.40</td></tr> </tbody> </table> <p>SMA Male to SMA Female Radius Right Angle VSWR 1.2:1 to 18 GHz Model No: PE91492</p>	PRICE	1-24	\$58.00	25-49	\$53.94	50-99	\$49.88	100+	\$46.40
	PRICE																																																	
1-24	\$26.94																																																	
25-49	\$25.59																																																	
50-99	\$24.25																																																	
100+	\$23.17																																																	
PRICE																																																		
1-24	\$31.40																																																	
25-49	\$29.83																																																	
50-99	\$28.26																																																	
100+	\$27.00																																																	
PRICE																																																		
1-24	\$52.31																																																	
25-49	\$49.69																																																	
50-99	\$47.08																																																	
PRECISION 100+	\$44.99																																																	
PRICE																																																		
1-9	\$149.17																																																	
10-24	\$141.71																																																	
25-49	\$134.25																																																	
PRECISION 50+	\$128.29																																																	
PRICE																																																		
1-24	\$58.00																																																	
25-49	\$53.94																																																	
50-99	\$49.88																																																	
100+	\$46.40																																																	

ADAPTERS

See Adapter Locator on Pages 8-13

See Page 369 for Mounting Holes

Adapters

See Our Website For Current Pricing & Real-Time Stock Availability!

	A	B	C	D	E																																																		
1	 <table border="1"> <thead> <tr><th colspan="2">PRICE</th></tr> </thead> <tbody> <tr><td>1-24</td><td>\$61.00</td></tr> <tr><td>25-49</td><td>\$56.73</td></tr> <tr><td>50-99</td><td>\$52.46</td></tr> <tr><td>100+</td><td>\$48.80</td></tr> </tbody> </table> <p>SMA Male to SMA Female Radius Right Angle VSWR 1.2:1 to 18 GHz</p> <p>Model No: PE91493</p>	PRICE		1-24	\$61.00	25-49	\$56.73	50-99	\$52.46	100+	\$48.80	 <table border="1"> <thead> <tr><th colspan="2">PRICE</th></tr> </thead> <tbody> <tr><td>1-24</td><td>\$87.64</td></tr> <tr><td>25-49</td><td>\$84.13</td></tr> <tr><td>50-99</td><td>\$81.51</td></tr> <tr><td>100+</td><td>\$79.75</td></tr> </tbody> </table> <p>SMA Male to SMA Female Radius Right Angle VSWR 1.25:1 to 18 GHz</p> <p>Model No: PE91155</p>	PRICE		1-24	\$87.64	25-49	\$84.13	50-99	\$81.51	100+	\$79.75	 <table border="1"> <thead> <tr><th colspan="2">PRICE</th></tr> </thead> <tbody> <tr><td>1-24</td><td>\$76.52</td></tr> <tr><td>25-49</td><td>\$72.69</td></tr> <tr><td>50-99</td><td>\$68.87</td></tr> <tr><td>100+</td><td>\$65.81</td></tr> </tbody> </table> <p>SMA Male to SMA Female Radius Right Angle VSWR 1.55:1 to 26.5 GHz</p> <p>Model No: PE91222</p>	PRICE		1-24	\$76.52	25-49	\$72.69	50-99	\$68.87	100+	\$65.81	 <table border="1"> <thead> <tr><th colspan="2">PRICE</th></tr> </thead> <tbody> <tr><td>1-24</td><td>\$31.17</td></tr> <tr><td>25-49</td><td>\$29.61</td></tr> <tr><td>50-99</td><td>\$28.05</td></tr> <tr><td>100+</td><td>\$26.81</td></tr> </tbody> </table> <p>SMA Male to SMA Female Right Angle VSWR 1.23:1 to 12.4 GHz</p> <p>Model No: PE9068</p>	PRICE		1-24	\$31.17	25-49	\$29.61	50-99	\$28.05	100+	\$26.81	 <table border="1"> <thead> <tr><th colspan="2">PRICE</th></tr> </thead> <tbody> <tr><td>1-24</td><td>\$98.04</td></tr> <tr><td>25-49</td><td>\$93.14</td></tr> <tr><td>50-99</td><td>\$88.24</td></tr> <tr><td>100+</td><td>\$84.31</td></tr> </tbody> </table> <p>PRECISION SMA Male to SMA Female 45 Degree Right VSWR 1.3:1 to 27 GHz</p> <p>Model No: PE91332</p>	PRICE		1-24	\$98.04	25-49	\$93.14	50-99	\$88.24	100+	\$84.31
	PRICE																																																						
1-24	\$61.00																																																						
25-49	\$56.73																																																						
50-99	\$52.46																																																						
100+	\$48.80																																																						
PRICE																																																							
1-24	\$87.64																																																						
25-49	\$84.13																																																						
50-99	\$81.51																																																						
100+	\$79.75																																																						
PRICE																																																							
1-24	\$76.52																																																						
25-49	\$72.69																																																						
50-99	\$68.87																																																						
100+	\$65.81																																																						
PRICE																																																							
1-24	\$31.17																																																						
25-49	\$29.61																																																						
50-99	\$28.05																																																						
100+	\$26.81																																																						
PRICE																																																							
1-24	\$98.04																																																						
25-49	\$93.14																																																						
50-99	\$88.24																																																						
100+	\$84.31																																																						
2	 <table border="1"> <thead> <tr><th colspan="2">PRICE</th></tr> </thead> <tbody> <tr><td>1-24</td><td>\$84.04</td></tr> <tr><td>25-49</td><td>\$79.84</td></tr> <tr><td>50-99</td><td>\$75.64</td></tr> <tr><td>100+</td><td>\$72.27</td></tr> </tbody> </table> <p>SMA Male to SMA Female Tee VSWR 2.25:1 to 6 GHz</p> <p>Model No: PE9247</p>	PRICE		1-24	\$84.04	25-49	\$79.84	50-99	\$75.64	100+	\$72.27	 <table border="1"> <thead> <tr><th colspan="2">PRICE</th></tr> </thead> <tbody> <tr><td>1-24</td><td>\$76.80</td></tr> <tr><td>25-49</td><td>\$72.96</td></tr> <tr><td>50-99</td><td>\$69.12</td></tr> <tr><td>100+</td><td>\$66.05</td></tr> </tbody> </table> <p>SMA Male to SMA Female Miter Right Angle VSWR 1.35:1 to 27 GHz</p> <p>Model No: PE91149</p>	PRICE		1-24	\$76.80	25-49	\$72.96	50-99	\$69.12	100+	\$66.05	 <table border="1"> <thead> <tr><th colspan="2">PRICE</th></tr> </thead> <tbody> <tr><td>1-24</td><td>\$83.79</td></tr> <tr><td>25-49</td><td>\$77.92</td></tr> <tr><td>50-99</td><td>\$72.06</td></tr> <tr><td>100+</td><td>\$67.03</td></tr> </tbody> </table> <p>PRECISION SMA Male to SMA Female Miter Right Angle VSWR 1.2:1 to 27 GHz</p> <p>Model No: PE91504</p>	PRICE		1-24	\$83.79	25-49	\$77.92	50-99	\$72.06	100+	\$67.03	 <table border="1"> <thead> <tr><th colspan="2">PRICE</th></tr> </thead> <tbody> <tr><td>1-24</td><td>\$62.54</td></tr> <tr><td>25-49</td><td>\$59.41</td></tr> <tr><td>50-99</td><td>\$56.29</td></tr> <tr><td>100+</td><td>\$53.78</td></tr> </tbody> </table> <p>SMA Male to SMA Female Bulkhead-Mounting Hole B02 VSWR 1.23:1 to 18 GHz</p> <p>Model No: PE9014</p>	PRICE		1-24	\$62.54	25-49	\$59.41	50-99	\$56.29	100+	\$53.78	 <table border="1"> <thead> <tr><th colspan="2">PRICE</th></tr> </thead> <tbody> <tr><td>1-24</td><td>\$55.77</td></tr> <tr><td>25-49</td><td>\$52.98</td></tr> <tr><td>50-99</td><td>\$50.19</td></tr> <tr><td>100+</td><td>\$47.96</td></tr> </tbody> </table> <p>SMA Male to SMA Female Bulkhead VSWR 1.3:1 to 18 GHz</p> <p>Model No: PE9621</p>	PRICE		1-24	\$55.77	25-49	\$52.98	50-99	\$50.19	100+	\$47.96
	PRICE																																																						
1-24	\$84.04																																																						
25-49	\$79.84																																																						
50-99	\$75.64																																																						
100+	\$72.27																																																						
PRICE																																																							
1-24	\$76.80																																																						
25-49	\$72.96																																																						
50-99	\$69.12																																																						
100+	\$66.05																																																						
PRICE																																																							
1-24	\$83.79																																																						
25-49	\$77.92																																																						
50-99	\$72.06																																																						
100+	\$67.03																																																						
PRICE																																																							
1-24	\$62.54																																																						
25-49	\$59.41																																																						
50-99	\$56.29																																																						
100+	\$53.78																																																						
PRICE																																																							
1-24	\$55.77																																																						
25-49	\$52.98																																																						
50-99	\$50.19																																																						
100+	\$47.96																																																						
3	 <table border="1"> <thead> <tr><th colspan="2">PRICE</th></tr> </thead> <tbody> <tr><td>1-24</td><td>\$27.14</td></tr> <tr><td>25-49</td><td>\$25.78</td></tr> <tr><td>50-99</td><td>\$24.43</td></tr> <tr><td>100+</td><td>\$23.34</td></tr> </tbody> </table> <p>Push-On SMA Male to SMA Female Bulkhead VSWR 1.23:1 to 18 GHz</p> <p>Model No: PE91321</p>	PRICE		1-24	\$27.14	25-49	\$25.78	50-99	\$24.43	100+	\$23.34	 <table border="1"> <thead> <tr><th colspan="2">PRICE</th></tr> </thead> <tbody> <tr><td>1-24</td><td>\$49.35</td></tr> <tr><td>25-49</td><td>\$46.88</td></tr> <tr><td>50-99</td><td>\$44.42</td></tr> <tr><td>100+</td><td>\$42.44</td></tr> </tbody> </table> <p>SMA Female to SMA Male Tee Max. Freq. 6 GHz</p> <p>Model No: PE9182</p>	PRICE		1-24	\$49.35	25-49	\$46.88	50-99	\$44.42	100+	\$42.44	 <table border="1"> <thead> <tr><th colspan="2">PRICE</th></tr> </thead> <tbody> <tr><td>1-24</td><td>\$18.78</td></tr> <tr><td>25-49</td><td>\$17.84</td></tr> <tr><td>50-99</td><td>\$16.90</td></tr> <tr><td>100+</td><td>\$16.15</td></tr> </tbody> </table> <p>SMA Female to SMA Female VSWR 1.25:1 to 18 GHz</p> <p>Model No: PE9070</p>	PRICE		1-24	\$18.78	25-49	\$17.84	50-99	\$16.90	100+	\$16.15	 <table border="1"> <thead> <tr><th colspan="2">PRICE</th></tr> </thead> <tbody> <tr><td>1-24</td><td>\$34.11</td></tr> <tr><td>25-49</td><td>\$32.40</td></tr> <tr><td>50-99</td><td>\$30.70</td></tr> <tr><td>100+</td><td>\$29.33</td></tr> </tbody> </table> <p>SMA Female to SMA Female VSWR 1.23:1 to 18 GHz</p> <p>Model No: PE9380</p>	PRICE		1-24	\$34.11	25-49	\$32.40	50-99	\$30.70	100+	\$29.33	 <table border="1"> <thead> <tr><th colspan="2">PRICE</th></tr> </thead> <tbody> <tr><td>1-24</td><td>\$65.03</td></tr> <tr><td>25-49</td><td>\$61.78</td></tr> <tr><td>50-99</td><td>\$58.53</td></tr> <tr><td>100+</td><td>\$55.93</td></tr> </tbody> </table> <p>PRECISION SMA Female to SMA Female VSWR 1.2:1 to 27 GHz</p> <p>Model No: PE9507</p>	PRICE		1-24	\$65.03	25-49	\$61.78	50-99	\$58.53	100+	\$55.93
	PRICE																																																						
1-24	\$27.14																																																						
25-49	\$25.78																																																						
50-99	\$24.43																																																						
100+	\$23.34																																																						
PRICE																																																							
1-24	\$49.35																																																						
25-49	\$46.88																																																						
50-99	\$44.42																																																						
100+	\$42.44																																																						
PRICE																																																							
1-24	\$18.78																																																						
25-49	\$17.84																																																						
50-99	\$16.90																																																						
100+	\$16.15																																																						
PRICE																																																							
1-24	\$34.11																																																						
25-49	\$32.40																																																						
50-99	\$30.70																																																						
100+	\$29.33																																																						
PRICE																																																							
1-24	\$65.03																																																						
25-49	\$61.78																																																						
50-99	\$58.53																																																						
100+	\$55.93																																																						
4	 <table border="1"> <thead> <tr><th colspan="2">PRICE</th></tr> </thead> <tbody> <tr><td>1-24</td><td>\$45.52</td></tr> <tr><td>25-49</td><td>\$43.24</td></tr> <tr><td>50-99</td><td>\$40.97</td></tr> <tr><td>100+</td><td>\$39.15</td></tr> </tbody> </table> <p>PRECISION SMA Female to SMA Female VSWR 1.15:1 to 18 GHz</p> <p>Model No: PE9695</p>	PRICE		1-24	\$45.52	25-49	\$43.24	50-99	\$40.97	100+	\$39.15	 <table border="1"> <thead> <tr><th colspan="2">PRICE</th></tr> </thead> <tbody> <tr><td>1-24</td><td>\$60.16</td></tr> <tr><td>25-49</td><td>\$57.15</td></tr> <tr><td>50-99</td><td>\$54.14</td></tr> <tr><td>100+</td><td>\$51.74</td></tr> </tbody> </table> <p>SMA Female to SMA Female Right Angle</p> <p>Model No: PE9485</p>	PRICE		1-24	\$60.16	25-49	\$57.15	50-99	\$54.14	100+	\$51.74	 <table border="1"> <thead> <tr><th colspan="2">PRICE</th></tr> </thead> <tbody> <tr><td>1-24</td><td>\$67.74</td></tr> <tr><td>25-49</td><td>\$64.35</td></tr> <tr><td>50-99</td><td>\$60.97</td></tr> <tr><td>100+</td><td>\$58.26</td></tr> </tbody> </table> <p>SMA Female to SMA Female Tee Max. Freq. 6 GHz</p> <p>Model No: PE9246</p>	PRICE		1-24	\$67.74	25-49	\$64.35	50-99	\$60.97	100+	\$58.26	 <table border="1"> <thead> <tr><th colspan="2">PRICE</th></tr> </thead> <tbody> <tr><td>1-24</td><td>\$20.11</td></tr> <tr><td>25-49</td><td>\$19.10</td></tr> <tr><td>50-99</td><td>\$18.10</td></tr> <tr><td>100+</td><td>\$17.29</td></tr> </tbody> </table> <p>SMA Female to SMA Female Bulkhead VSWR 1.25:1 to 18 GHz</p> <p>Model No: PE91258</p>	PRICE		1-24	\$20.11	25-49	\$19.10	50-99	\$18.10	100+	\$17.29	 <table border="1"> <thead> <tr><th colspan="2">PRICE</th></tr> </thead> <tbody> <tr><td>1-9</td><td>\$113.12</td></tr> <tr><td>10-24</td><td>\$107.46</td></tr> <tr><td>25-49</td><td>\$101.81</td></tr> <tr><td>50+</td><td>\$97.28</td></tr> </tbody> </table> <p>SMA Female to SMA Female Bulkhead-Mounting Hole B02 VSWR 1.3:1 to 26.5 GHz</p> <p>Model No: PE9508</p>	PRICE		1-9	\$113.12	10-24	\$107.46	25-49	\$101.81	50+	\$97.28
	PRICE																																																						
1-24	\$45.52																																																						
25-49	\$43.24																																																						
50-99	\$40.97																																																						
100+	\$39.15																																																						
PRICE																																																							
1-24	\$60.16																																																						
25-49	\$57.15																																																						
50-99	\$54.14																																																						
100+	\$51.74																																																						
PRICE																																																							
1-24	\$67.74																																																						
25-49	\$64.35																																																						
50-99	\$60.97																																																						
100+	\$58.26																																																						
PRICE																																																							
1-24	\$20.11																																																						
25-49	\$19.10																																																						
50-99	\$18.10																																																						
100+	\$17.29																																																						
PRICE																																																							
1-9	\$113.12																																																						
10-24	\$107.46																																																						
25-49	\$101.81																																																						
50+	\$97.28																																																						
5	 <table border="1"> <thead> <tr><th colspan="2">PRICE</th></tr> </thead> <tbody> <tr><td>1-24</td><td>\$46.59</td></tr> <tr><td>25-49</td><td>\$44.26</td></tr> <tr><td>50-99</td><td>\$41.93</td></tr> <tr><td>100+</td><td>\$40.07</td></tr> </tbody> </table> <p>PRECISION SMA Female to SMA Female Bulkhead-Mounting Hole B02 VSWR 1.15:1 to 18 GHz</p> <p>Model No: PE9620</p>	PRICE		1-24	\$46.59	25-49	\$44.26	50-99	\$41.93	100+	\$40.07	 <table border="1"> <thead> <tr><th colspan="2">PRICE</th></tr> </thead> <tbody> <tr><td>1-9</td><td>Call</td></tr> <tr><td>10-24</td><td>Call</td></tr> <tr><td>25-49</td><td>Call</td></tr> <tr><td>50+</td><td>Call</td></tr> </tbody> </table> <p>NEW SMA Female to SMA Female Bulkhead VSWR 1.35:1 to 18 GHz</p> <p>Model No: PE91393</p>	PRICE		1-9	Call	10-24	Call	25-49	Call	50+	Call	 <table border="1"> <thead> <tr><th colspan="2">PRICE</th></tr> </thead> <tbody> <tr><td>1-24</td><td>\$48.11</td></tr> <tr><td>25-49</td><td>\$45.70</td></tr> <tr><td>50-99</td><td>\$43.30</td></tr> <tr><td>100+</td><td>\$41.37</td></tr> </tbody> </table> <p>SMA Female to SMA Female Bulkhead VSWR 1.4:1 to 18 GHz</p> <p>Model No: PE9184</p>	PRICE		1-24	\$48.11	25-49	\$45.70	50-99	\$43.30	100+	\$41.37	 <table border="1"> <thead> <tr><th colspan="2">PRICE</th></tr> </thead> <tbody> <tr><td>1-24</td><td>\$36.08</td></tr> <tr><td>25-49</td><td>\$34.28</td></tr> <tr><td>50-99</td><td>\$32.47</td></tr> <tr><td>100+</td><td>\$31.03</td></tr> </tbody> </table> <p>SMA Female to SMA Female Bulkhead VSWR 1.25:1 to 12.4 GHz</p> <p>Model No: PE9067</p>	PRICE		1-24	\$36.08	25-49	\$34.28	50-99	\$32.47	100+	\$31.03	 <table border="1"> <thead> <tr><th colspan="2">PRICE</th></tr> </thead> <tbody> <tr><td>1-24</td><td>\$65.84</td></tr> <tr><td>25-49</td><td>\$62.55</td></tr> <tr><td>50-99</td><td>\$59.26</td></tr> <tr><td>100+</td><td>\$56.62</td></tr> </tbody> </table> <p>SMA Female to SMA Female 4 Hole Flange-Mounting Hole A01 VSWR 1.25:1 to 18 GHz</p> <p>Model No: PE9312</p>	PRICE		1-24	\$65.84	25-49	\$62.55	50-99	\$59.26	100+	\$56.62
	PRICE																																																						
1-24	\$46.59																																																						
25-49	\$44.26																																																						
50-99	\$41.93																																																						
100+	\$40.07																																																						
PRICE																																																							
1-9	Call																																																						
10-24	Call																																																						
25-49	Call																																																						
50+	Call																																																						
PRICE																																																							
1-24	\$48.11																																																						
25-49	\$45.70																																																						
50-99	\$43.30																																																						
100+	\$41.37																																																						
PRICE																																																							
1-24	\$36.08																																																						
25-49	\$34.28																																																						
50-99	\$32.47																																																						
100+	\$31.03																																																						
PRICE																																																							
1-24	\$65.84																																																						
25-49	\$62.55																																																						
50-99	\$59.26																																																						
100+	\$56.62																																																						
6	 <table border="1"> <thead> <tr><th colspan="2">PRICE</th></tr> </thead> <tbody> <tr><td>1-24</td><td>\$94.19</td></tr> <tr><td>25-49</td><td>\$89.48</td></tr> <tr><td>50-99</td><td>\$84.77</td></tr> <tr><td>100+</td><td>\$81.00</td></tr> </tbody> </table> <p>SMA Female to SMA Female 4 Hole Flange-Mounting Hole A01 VSWR 1.25:1 to 18 GHz</p> <p>Model No: PE9670</p>	PRICE		1-24	\$94.19	25-49	\$89.48	50-99	\$84.77	100+	\$81.00	 <table border="1"> <thead> <tr><th colspan="2">PRICE</th></tr> </thead> <tbody> <tr><td>1-24</td><td>\$24.21</td></tr> <tr><td>25-49</td><td>\$23.00</td></tr> <tr><td>50-99</td><td>\$21.79</td></tr> <tr><td>100+</td><td>\$20.82</td></tr> </tbody> </table> <p>SMA Female to SMA Female Bulkhead VSWR 1.23:1 to 18 GHz</p> <p>Model No: PE9184NH</p>	PRICE		1-24	\$24.21	25-49	\$23.00	50-99	\$21.79	100+	\$20.82	 <table border="1"> <thead> <tr><th colspan="2">PRICE</th></tr> </thead> <tbody> <tr><td>1-24</td><td>\$21.04</td></tr> <tr><td>25-49</td><td>\$19.99</td></tr> <tr><td>50-99</td><td>\$18.94</td></tr> <tr><td>100+</td><td>\$18.09</td></tr> </tbody> </table> <p>SMA Female to SMA Female 2 Hole Flange VSWR 1.25:1 to 18 GHz</p> <p>Model No: PE91290</p>	PRICE		1-24	\$21.04	25-49	\$19.99	50-99	\$18.94	100+	\$18.09	<p>Reverse Polarity SMA In-Series</p> 																					
	PRICE																																																						
1-24	\$94.19																																																						
25-49	\$89.48																																																						
50-99	\$84.77																																																						
100+	\$81.00																																																						
PRICE																																																							
1-24	\$24.21																																																						
25-49	\$23.00																																																						
50-99	\$21.79																																																						
100+	\$20.82																																																						
PRICE																																																							
1-24	\$21.04																																																						
25-49	\$19.99																																																						
50-99	\$18.94																																																						
100+	\$18.09																																																						
7	 <table border="1"> <thead> <tr><th colspan="2">PRICE</th></tr> </thead> <tbody> <tr><td>1-24</td><td>\$68.10</td></tr> <tr><td>25-49</td><td>\$64.70</td></tr> <tr><td>50-99</td><td>\$61.29</td></tr> <tr><td>100+</td><td>\$58.57</td></tr> </tbody> </table> <p>QD SMA Male to Rev. Pol. SMA Female VSWR 1.25:1 to 18 GHz</p> <p>Model No: PE91265</p>	PRICE		1-24	\$68.10	25-49	\$64.70	50-99	\$61.29	100+	\$58.57	 <table border="1"> <thead> <tr><th colspan="2">PRICE</th></tr> </thead> <tbody> <tr><td>1-24</td><td>\$42.26</td></tr> <tr><td>25-49</td><td>\$40.15</td></tr> <tr><td>50-99</td><td>\$38.03</td></tr> <tr><td>100+</td><td>\$36.34</td></tr> </tbody> </table> <p>SMA Male to Rev. Pol. SMA Female VSWR 1.25:1 to 18 GHz</p> <p>Model No: PE9534</p>	PRICE		1-24	\$42.26	25-49	\$40.15	50-99	\$38.03	100+	\$36.34	 <table border="1"> <thead> <tr><th colspan="2">PRICE</th></tr> </thead> <tbody> <tr><td>1-24</td><td>\$46.67</td></tr> <tr><td>25-49</td><td>\$44.34</td></tr> <tr><td>50-99</td><td>\$42.00</td></tr> <tr><td>100+</td><td>\$40.14</td></tr> </tbody> </table> <p>SMA Male to Rev. Pol. SMA Female Right Angle VSWR 1.23:1 to 12.4 GHz</p> <p>Model No: PE91264</p>	PRICE		1-24	\$46.67	25-49	\$44.34	50-99	\$42.00	100+	\$40.14	 <table border="1"> <thead> <tr><th colspan="2">PRICE</th></tr> </thead> <tbody> <tr><td>1-24</td><td>\$23.46</td></tr> <tr><td>25-49</td><td>\$22.29</td></tr> <tr><td>50-99</td><td>\$21.11</td></tr> <tr><td>100+</td><td>\$20.18</td></tr> </tbody> </table> <p>SMA Female to Rev. Pol. SMA Male VSWR 1.25:1 to 18 GHz</p> <p>Model No: PE9533</p>	PRICE		1-24	\$23.46	25-49	\$22.29	50-99	\$21.11	100+	\$20.18	 <table border="1"> <thead> <tr><th colspan="2">PRICE</th></tr> </thead> <tbody> <tr><td>1-24</td><td>\$37.54</td></tr> <tr><td>25-49</td><td>\$35.66</td></tr> <tr><td>50-99</td><td>\$33.79</td></tr> <tr><td>100+</td><td>\$32.28</td></tr> </tbody> </table> <p>SMA Female to Rev. Pol. SMA Female VSWR 1.2:1 to 18 GHz</p> <p>Model No: PE91260</p>	PRICE		1-24	\$37.54	25-49	\$35.66	50-99	\$33.79	100+	\$32.28
	PRICE																																																						
1-24	\$68.10																																																						
25-49	\$64.70																																																						
50-99	\$61.29																																																						
100+	\$58.57																																																						
PRICE																																																							
1-24	\$42.26																																																						
25-49	\$40.15																																																						
50-99	\$38.03																																																						
100+	\$36.34																																																						
PRICE																																																							
1-24	\$46.67																																																						
25-49	\$44.34																																																						
50-99	\$42.00																																																						
100+	\$40.14																																																						
PRICE																																																							
1-24	\$23.46																																																						
25-49	\$22.29																																																						
50-99	\$21.11																																																						
100+	\$20.18																																																						
PRICE																																																							
1-24	\$37.54																																																						
25-49	\$35.66																																																						
50-99	\$33.79																																																						
100+	\$32.28																																																						

ADAPTERS

See Adapter Locator on Pages 8-13

See Page 369 for Mounting Holes

	A	B	C	D	E																																													
1	 <table border="1"> <thead> <tr><th>PRICE</th></tr> </thead> <tbody> <tr><td>1-24</td><td>\$113.55</td></tr> <tr><td>25-49</td><td>\$107.87</td></tr> <tr><td>50-99</td><td>\$102.20</td></tr> <tr><td>100+</td><td>\$97.65</td></tr> </tbody> </table> <p>QD Rev. Pol. SMA Male to SMA Male VSWR 1.25:1 to 18 GHz Model No: PE91266</p>	PRICE	1-24	\$113.55	25-49	\$107.87	50-99	\$102.20	100+	\$97.65	 <table border="1"> <thead> <tr><th>PRICE</th></tr> </thead> <tbody> <tr><td>1-24</td><td>\$68.10</td></tr> <tr><td>25-49</td><td>\$64.70</td></tr> <tr><td>50-99</td><td>\$61.29</td></tr> <tr><td>100+</td><td>\$58.57</td></tr> </tbody> </table> <p>QD Rev. Pol. SMA Male to SMA Female VSWR 1.25:1 to 18 GHz Model No: PE91267</p>	PRICE	1-24	\$68.10	25-49	\$64.70	50-99	\$61.29	100+	\$58.57	 <table border="1"> <thead> <tr><th>PRICE</th></tr> </thead> <tbody> <tr><td>1-24</td><td>\$38.24</td></tr> <tr><td>25-49</td><td>\$36.33</td></tr> <tr><td>50-99</td><td>\$34.42</td></tr> <tr><td>100+</td><td>\$32.89</td></tr> </tbody> </table> <p>Rev. Pol. SMA Male to SMA Female Right Angle VSWR 1.23:1 to 12.4 GHz Model No: PE91263</p>	PRICE	1-24	\$38.24	25-49	\$36.33	50-99	\$34.42	100+	\$32.89	 <table border="1"> <thead> <tr><th>PRICE</th></tr> </thead> <tbody> <tr><td>1-24</td><td>\$45.39</td></tr> <tr><td>25-49</td><td>\$43.12</td></tr> <tr><td>50-99</td><td>\$40.85</td></tr> <tr><td>100+</td><td>\$39.04</td></tr> </tbody> </table> <p>Rev. Pol. SMA Male to Rev. Pol. SMA Male VSWR 1.2:1 to 18 GHz Model No: PE91261</p>	PRICE	1-24	\$45.39	25-49	\$43.12	50-99	\$40.85	100+	\$39.04	 <table border="1"> <thead> <tr><th>PRICE</th></tr> </thead> <tbody> <tr><td>1-24</td><td>\$55.97</td></tr> <tr><td>25-49</td><td>\$53.17</td></tr> <tr><td>50-99</td><td>\$50.37</td></tr> <tr><td>100+</td><td>\$48.13</td></tr> </tbody> </table> <p>Rev. Pol. SMA Male to Rev. Pol. SMA Male VSWR 1.35:1 to 6 GHz Model No: PE91330</p>	PRICE	1-24	\$55.97	25-49	\$53.17	50-99	\$50.37	100+	\$48.13
	PRICE																																																	
1-24	\$113.55																																																	
25-49	\$107.87																																																	
50-99	\$102.20																																																	
100+	\$97.65																																																	
PRICE																																																		
1-24	\$68.10																																																	
25-49	\$64.70																																																	
50-99	\$61.29																																																	
100+	\$58.57																																																	
PRICE																																																		
1-24	\$38.24																																																	
25-49	\$36.33																																																	
50-99	\$34.42																																																	
100+	\$32.89																																																	
PRICE																																																		
1-24	\$45.39																																																	
25-49	\$43.12																																																	
50-99	\$40.85																																																	
100+	\$39.04																																																	
PRICE																																																		
1-24	\$55.97																																																	
25-49	\$53.17																																																	
50-99	\$50.37																																																	
100+	\$48.13																																																	
2	 <table border="1"> <thead> <tr><th>PRICE</th></tr> </thead> <tbody> <tr><td>1-24</td><td>\$68.10</td></tr> <tr><td>25-49</td><td>\$64.70</td></tr> <tr><td>50-99</td><td>\$61.29</td></tr> <tr><td>100+</td><td>\$58.57</td></tr> </tbody> </table> <p>QD Rev. Pol. SMA Male to Rev. Pol. SMA Female VSWR 1.25:1 to 18 GHz Model No: PE91268</p>	PRICE	1-24	\$68.10	25-49	\$64.70	50-99	\$61.29	100+	\$58.57	 <table border="1"> <thead> <tr><th>PRICE</th></tr> </thead> <tbody> <tr><td>1-24</td><td>\$55.85</td></tr> <tr><td>25-49</td><td>\$53.06</td></tr> <tr><td>50-99</td><td>\$50.27</td></tr> <tr><td>100+</td><td>\$48.03</td></tr> </tbody> </table> <p>Rev. Pol. SMA Male to Rev. Pol. SMA Female VSWR 1.35:1 to 6 GHz Model No: PE91331</p>	PRICE	1-24	\$55.85	25-49	\$53.06	50-99	\$50.27	100+	\$48.03	 <table border="1"> <thead> <tr><th>PRICE</th></tr> </thead> <tbody> <tr><td>1-24</td><td>\$37.54</td></tr> <tr><td>25-49</td><td>\$35.66</td></tr> <tr><td>50-99</td><td>\$33.79</td></tr> <tr><td>100+</td><td>\$32.28</td></tr> </tbody> </table> <p>Rev. Pol. SMA Male to Rev. Pol. SMA Female Right Angle VSWR 1.25:1 to 6 GHz Model No: PE9594</p>	PRICE	1-24	\$37.54	25-49	\$35.66	50-99	\$33.79	100+	\$32.28	 <table border="1"> <thead> <tr><th>PRICE</th></tr> </thead> <tbody> <tr><td>1-24</td><td>\$45.39</td></tr> <tr><td>25-49</td><td>\$43.12</td></tr> <tr><td>50-99</td><td>\$40.85</td></tr> <tr><td>100+</td><td>\$39.04</td></tr> </tbody> </table> <p>Rev. Pol. SMA Female to Rev. Pol. SMA Female VSWR 1.2:1 to 18 GHz Model No: PE91262</p>	PRICE	1-24	\$45.39	25-49	\$43.12	50-99	\$40.85	100+	\$39.04	 <table border="1"> <thead> <tr><th>PRICE</th></tr> </thead> <tbody> <tr><td>1-24</td><td>\$36.83</td></tr> <tr><td>25-49</td><td>\$34.99</td></tr> <tr><td>50-99</td><td>\$33.15</td></tr> <tr><td>100+</td><td>\$31.67</td></tr> </tbody> </table> <p>Rev. Pol. SMA Female to Rev. Pol. SMA Female VSWR 1.35:1 to 6 GHz Model No: PE91334</p>	PRICE	1-24	\$36.83	25-49	\$34.99	50-99	\$33.15	100+	\$31.67
	PRICE																																																	
1-24	\$68.10																																																	
25-49	\$64.70																																																	
50-99	\$61.29																																																	
100+	\$58.57																																																	
PRICE																																																		
1-24	\$55.85																																																	
25-49	\$53.06																																																	
50-99	\$50.27																																																	
100+	\$48.03																																																	
PRICE																																																		
1-24	\$37.54																																																	
25-49	\$35.66																																																	
50-99	\$33.79																																																	
100+	\$32.28																																																	
PRICE																																																		
1-24	\$45.39																																																	
25-49	\$43.12																																																	
50-99	\$40.85																																																	
100+	\$39.04																																																	
PRICE																																																		
1-24	\$36.83																																																	
25-49	\$34.99																																																	
50-99	\$33.15																																																	
100+	\$31.67																																																	
3	 <table border="1"> <thead> <tr><th>PRICE</th></tr> </thead> <tbody> <tr><td>1-24</td><td>\$53.06</td></tr> <tr><td>25-49</td><td>\$50.41</td></tr> <tr><td>50-99</td><td>\$47.75</td></tr> <tr><td>100+</td><td>\$45.63</td></tr> </tbody> </table> <p>Rev. Pol. SMA Female to Rev. Pol. SMA Female Bulkhead-Mounting Hole B02 VSWR 1.25:1 to 18 GHz Model No: PE9593</p>	PRICE	1-24	\$53.06	25-49	\$50.41	50-99	\$47.75	100+	\$45.63	 <table border="1"> <thead> <tr><th>PRICE</th></tr> </thead> <tbody> <tr><td>1-24</td><td>\$46.74</td></tr> <tr><td>25-49</td><td>\$44.40</td></tr> <tr><td>50-99</td><td>\$42.07</td></tr> <tr><td>100+</td><td>\$40.20</td></tr> </tbody> </table> <p>Rev. Pol. SMA Female to Rev. Pol. SMA Female 2 Hole Flange VSWR 1.2:1 to 18 GHz Model No: PE91270</p>	PRICE	1-24	\$46.74	25-49	\$44.40	50-99	\$42.07	100+	\$40.20	 <table border="1"> <thead> <tr><th>PRICE</th></tr> </thead> <tbody> <tr><td>1-24</td><td>\$48.28</td></tr> <tr><td>25-49</td><td>\$45.87</td></tr> <tr><td>50-99</td><td>\$43.45</td></tr> <tr><td>100+</td><td>\$41.52</td></tr> </tbody> </table> <p>Rev. Pol. SMA Female to Rev. Pol. SMA Female 4 Hole Flange VSWR 1.2:1 to 18 GHz Model No: PE91269</p>	PRICE	1-24	\$48.28	25-49	\$45.87	50-99	\$43.45	100+	\$41.52	<p>Reverse Thread SMA In-Series</p> 																			
	PRICE																																																	
1-24	\$53.06																																																	
25-49	\$50.41																																																	
50-99	\$47.75																																																	
100+	\$45.63																																																	
PRICE																																																		
1-24	\$46.74																																																	
25-49	\$44.40																																																	
50-99	\$42.07																																																	
100+	\$40.20																																																	
PRICE																																																		
1-24	\$48.28																																																	
25-49	\$45.87																																																	
50-99	\$43.45																																																	
100+	\$41.52																																																	
4	 <table border="1"> <thead> <tr><th>PRICE</th></tr> </thead> <tbody> <tr><td>1-24</td><td>\$61.36</td></tr> <tr><td>25-49</td><td>\$58.29</td></tr> <tr><td>50-99</td><td>\$55.22</td></tr> <tr><td>100+</td><td>\$52.77</td></tr> </tbody> </table> <p>SMA Female to Reverse Thread SMA Male Model No: PE9683</p>	PRICE	1-24	\$61.36	25-49	\$58.29	50-99	\$55.22	100+	\$52.77	<p>SMA Between Series</p> 		 <table border="1"> <thead> <tr><th>PRICE</th></tr> </thead> <tbody> <tr><td>1-24</td><td>\$117.37</td></tr> <tr><td>25-49</td><td>\$111.50</td></tr> <tr><td>50-99</td><td>\$105.63</td></tr> <tr><td>100+</td><td>\$100.94</td></tr> </tbody> </table> <p>SMA Male to 1.0/2.3 Plug Model No: PE9692</p>	PRICE	1-24	\$117.37	25-49	\$111.50	50-99	\$105.63	100+	\$100.94	 <table border="1"> <thead> <tr><th>PRICE</th></tr> </thead> <tbody> <tr><td>1-24</td><td>\$96.12</td></tr> <tr><td>25-49</td><td>\$91.31</td></tr> <tr><td>50-99</td><td>\$86.51</td></tr> <tr><td>100+</td><td>\$82.66</td></tr> </tbody> </table> <p>SMA Male to 1.0/2.3 Jack Model No: PE9690</p>	PRICE	1-24	\$96.12	25-49	\$91.31	50-99	\$86.51	100+	\$82.66																		
	PRICE																																																	
1-24	\$61.36																																																	
25-49	\$58.29																																																	
50-99	\$55.22																																																	
100+	\$52.77																																																	
PRICE																																																		
1-24	\$117.37																																																	
25-49	\$111.50																																																	
50-99	\$105.63																																																	
100+	\$100.94																																																	
PRICE																																																		
1-24	\$96.12																																																	
25-49	\$91.31																																																	
50-99	\$86.51																																																	
100+	\$82.66																																																	
5	 <table border="1"> <thead> <tr><th>PRICE</th></tr> </thead> <tbody> <tr><td>1-9</td><td>\$222.33</td></tr> <tr><td>10-24</td><td>\$211.21</td></tr> <tr><td>25-49</td><td>\$200.10</td></tr> <tr><td>50+</td><td>\$191.20</td></tr> </tbody> </table> <p>SMA Male to 1.85mm Female VSWR 1.3:1 to 18 GHz Model No: PE9728</p>	PRICE	1-9	\$222.33	10-24	\$211.21	25-49	\$200.10	50+	\$191.20	 <table border="1"> <thead> <tr><th>PRICE</th></tr> </thead> <tbody> <tr><td>1-9</td><td>\$208.85</td></tr> <tr><td>10-24</td><td>\$198.41</td></tr> <tr><td>25-49</td><td>\$187.97</td></tr> <tr><td>50+</td><td>\$179.61</td></tr> </tbody> </table> <p>PRECISION SMA Male to 2.4mm Male VSWR 1.2:1 to 26.5 GHz Model No: PE9653</p>	PRICE	1-9	\$208.85	10-24	\$198.41	25-49	\$187.97	50+	\$179.61	 <table border="1"> <thead> <tr><th>PRICE</th></tr> </thead> <tbody> <tr><td>1-9</td><td>\$229.87</td></tr> <tr><td>10-24</td><td>\$218.38</td></tr> <tr><td>25-49</td><td>\$206.88</td></tr> <tr><td>50+</td><td>\$197.69</td></tr> </tbody> </table> <p>PRECISION SMA Male to 2.4mm Female VSWR 1.2:1 to 26.5 GHz Model No: PE9654</p>	PRICE	1-9	\$229.87	10-24	\$218.38	25-49	\$206.88	50+	\$197.69	 <table border="1"> <thead> <tr><th>PRICE</th></tr> </thead> <tbody> <tr><td>1-9</td><td>\$215.22</td></tr> <tr><td>10-24</td><td>\$204.46</td></tr> <tr><td>25-49</td><td>\$193.70</td></tr> <tr><td>50+</td><td>\$185.09</td></tr> </tbody> </table> <p>PRECISION SMA Male to 2.92mm Male VSWR 1.2:1 to 26.5 GHz Model No: PE91010</p>	PRICE	1-9	\$215.22	10-24	\$204.46	25-49	\$193.70	50+	\$185.09	 <table border="1"> <thead> <tr><th>PRICE</th></tr> </thead> <tbody> <tr><td>1-9</td><td>\$211.08</td></tr> <tr><td>10-24</td><td>\$200.53</td></tr> <tr><td>25-49</td><td>\$189.97</td></tr> <tr><td>50+</td><td>\$181.53</td></tr> </tbody> </table> <p>PRECISION SMA Male to 2.92mm Female VSWR 1.2:1 to 26.5 GHz Model No: PE91008</p>	PRICE	1-9	\$211.08	10-24	\$200.53	25-49	\$189.97	50+	\$181.53
	PRICE																																																	
1-9	\$222.33																																																	
10-24	\$211.21																																																	
25-49	\$200.10																																																	
50+	\$191.20																																																	
PRICE																																																		
1-9	\$208.85																																																	
10-24	\$198.41																																																	
25-49	\$187.97																																																	
50+	\$179.61																																																	
PRICE																																																		
1-9	\$229.87																																																	
10-24	\$218.38																																																	
25-49	\$206.88																																																	
50+	\$197.69																																																	
PRICE																																																		
1-9	\$215.22																																																	
10-24	\$204.46																																																	
25-49	\$193.70																																																	
50+	\$185.09																																																	
PRICE																																																		
1-9	\$211.08																																																	
10-24	\$200.53																																																	
25-49	\$189.97																																																	
50+	\$181.53																																																	
6	 <table border="1"> <thead> <tr><th>PRICE</th></tr> </thead> <tbody> <tr><td>1-9</td><td>\$212.43</td></tr> <tr><td>10-24</td><td>\$201.81</td></tr> <tr><td>25-49</td><td>\$191.19</td></tr> <tr><td>50+</td><td>\$182.69</td></tr> </tbody> </table> <p>SMA Male to 3.5mm Male VSWR 1.25:1 to 18 GHz Model No: PE9722</p>	PRICE	1-9	\$212.43	10-24	\$201.81	25-49	\$191.19	50+	\$182.69	 <table border="1"> <thead> <tr><th>PRICE</th></tr> </thead> <tbody> <tr><td>1-4</td><td>\$526.44</td></tr> <tr><td>5-9</td><td>\$500.12</td></tr> <tr><td>10-24</td><td>\$473.80</td></tr> <tr><td>25+</td><td>\$452.74</td></tr> </tbody> </table> <p>PRECISION SMA Male to 7mm Sexless VSWR 1.15:1 to 18 GHz Model No: PE9215</p>	PRICE	1-4	\$526.44	5-9	\$500.12	10-24	\$473.80	25+	\$452.74	 <table border="1"> <thead> <tr><th>PRICE</th></tr> </thead> <tbody> <tr><td>1-9</td><td>\$119.52</td></tr> <tr><td>10-24</td><td>\$113.54</td></tr> <tr><td>25-49</td><td>\$107.57</td></tr> <tr><td>50+</td><td>\$102.79</td></tr> </tbody> </table> <p>Low PIM SMA Male to 7/16 DIN Male VSWR 1.09:1 to 7.5 GHz Model No: PE91043</p>	PRICE	1-9	\$119.52	10-24	\$113.54	25-49	\$107.57	50+	\$102.79	 <table border="1"> <thead> <tr><th>PRICE</th></tr> </thead> <tbody> <tr><td>1-9</td><td>\$107.89</td></tr> <tr><td>10-24</td><td>\$102.50</td></tr> <tr><td>25-49</td><td>\$97.10</td></tr> <tr><td>50+</td><td>\$92.79</td></tr> </tbody> </table> <p>Low PIM SMA Male to 7/16 DIN Female Max. Freq. 8 GHz Model No: PE91041</p>	PRICE	1-9	\$107.89	10-24	\$102.50	25-49	\$97.10	50+	\$92.79	 <table border="1"> <thead> <tr><th>PRICE</th></tr> </thead> <tbody> <tr><td>1-9</td><td>\$170.61</td></tr> <tr><td>10-24</td><td>\$162.08</td></tr> <tr><td>25-49</td><td>\$153.55</td></tr> <tr><td>50+</td><td>\$146.72</td></tr> </tbody> </table> <p>SMA Male to 7/16 DIN Female Model No: PE9411</p>	PRICE	1-9	\$170.61	10-24	\$162.08	25-49	\$153.55	50+	\$146.72
	PRICE																																																	
1-9	\$212.43																																																	
10-24	\$201.81																																																	
25-49	\$191.19																																																	
50+	\$182.69																																																	
PRICE																																																		
1-4	\$526.44																																																	
5-9	\$500.12																																																	
10-24	\$473.80																																																	
25+	\$452.74																																																	
PRICE																																																		
1-9	\$119.52																																																	
10-24	\$113.54																																																	
25-49	\$107.57																																																	
50+	\$102.79																																																	
PRICE																																																		
1-9	\$107.89																																																	
10-24	\$102.50																																																	
25-49	\$97.10																																																	
50+	\$92.79																																																	
PRICE																																																		
1-9	\$170.61																																																	
10-24	\$162.08																																																	
25-49	\$153.55																																																	
50+	\$146.72																																																	
7	 <table border="1"> <thead> <tr><th>PRICE</th></tr> </thead> <tbody> <tr><td>1-24</td><td>\$44.11</td></tr> <tr><td>25-49</td><td>\$41.90</td></tr> <tr><td>50-99</td><td>\$39.70</td></tr> <tr><td>100+</td><td>\$37.93</td></tr> </tbody> </table> <p>SMA Male to BNC Male Max. Freq. 4 GHz Model No: PE9072</p>	PRICE	1-24	\$44.11	25-49	\$41.90	50-99	\$39.70	100+	\$37.93	 <table border="1"> <thead> <tr><th>PRICE</th></tr> </thead> <tbody> <tr><td>1-24</td><td>\$113.61</td></tr> <tr><td>25-49</td><td>\$107.93</td></tr> <tr><td>50-99</td><td>\$102.25</td></tr> <tr><td>100+</td><td>\$97.70</td></tr> </tbody> </table> <p>SMA Male to BNC Male VSWR 1.25:1 to 8 GHz Model No: PE9493</p>	PRICE	1-24	\$113.61	25-49	\$107.93	50-99	\$102.25	100+	\$97.70	 <table border="1"> <thead> <tr><th>PRICE</th></tr> </thead> <tbody> <tr><td>1-24</td><td>\$27.87</td></tr> <tr><td>25-49</td><td>\$26.48</td></tr> <tr><td>50-99</td><td>\$25.08</td></tr> <tr><td>100+</td><td>\$23.97</td></tr> </tbody> </table> <p>SMA Male to BNC Female VSWR 1.3:1 to 4 GHz Model No: PE9074</p>	PRICE	1-24	\$27.87	25-49	\$26.48	50-99	\$25.08	100+	\$23.97	 <table border="1"> <thead> <tr><th>PRICE</th></tr> </thead> <tbody> <tr><td>1-9</td><td>\$148.74</td></tr> <tr><td>10-24</td><td>\$141.30</td></tr> <tr><td>25-49</td><td>\$133.87</td></tr> <tr><td>50+</td><td>\$127.92</td></tr> </tbody> </table> <p>SMA Male to BNC Female VSWR 1.25:1 to 8 GHz Model No: PE9495</p>	PRICE	1-9	\$148.74	10-24	\$141.30	25-49	\$133.87	50+	\$127.92	 <table border="1"> <thead> <tr><th>PRICE</th></tr> </thead> <tbody> <tr><td>1-24</td><td>\$35.98</td></tr> <tr><td>25-49</td><td>\$34.18</td></tr> <tr><td>50-99</td><td>\$32.38</td></tr> <tr><td>100+</td><td>\$30.94</td></tr> </tbody> </table> <p>SMA Male to 75 Ohm F Female Max. Freq. 2 GHz Model No: PE91003</p>	PRICE	1-24	\$35.98	25-49	\$34.18	50-99	\$32.38	100+	\$30.94
	PRICE																																																	
1-24	\$44.11																																																	
25-49	\$41.90																																																	
50-99	\$39.70																																																	
100+	\$37.93																																																	
PRICE																																																		
1-24	\$113.61																																																	
25-49	\$107.93																																																	
50-99	\$102.25																																																	
100+	\$97.70																																																	
PRICE																																																		
1-24	\$27.87																																																	
25-49	\$26.48																																																	
50-99	\$25.08																																																	
100+	\$23.97																																																	
PRICE																																																		
1-9	\$148.74																																																	
10-24	\$141.30																																																	
25-49	\$133.87																																																	
50+	\$127.92																																																	
PRICE																																																		
1-24	\$35.98																																																	
25-49	\$34.18																																																	
50-99	\$32.38																																																	
100+	\$30.94																																																	

ADAPTERS

See Adapter Locator on Pages 8-13

See Page 369 for Mounting Holes

	A	B	C	D	E																																																		
1	 <table border="1"> <thead> <tr> <th colspan="2">PRICE</th> </tr> </thead> <tbody> <tr> <td>1-24</td> <td>\$23.07</td> </tr> <tr> <td>25-49</td> <td>\$21.92</td> </tr> <tr> <td>50-99</td> <td>\$20.76</td> </tr> <tr> <td>100+</td> <td>\$19.84</td> </tr> </tbody> </table> <p>SMA Male to FME Jack</p> <p>Model No: PE9707</p>	PRICE		1-24	\$23.07	25-49	\$21.92	50-99	\$20.76	100+	\$19.84	 <table border="1"> <thead> <tr> <th colspan="2">PRICE</th> </tr> </thead> <tbody> <tr> <td>1-9</td> <td>\$244.12</td> </tr> <tr> <td>10-24</td> <td>\$231.91</td> </tr> <tr> <td>25-49</td> <td>\$219.71</td> </tr> <tr> <td>50+</td> <td>\$209.94</td> </tr> </tbody> </table> <p>SMA Male to GR874 Sexless</p> <p>Model No: PE9259</p>	PRICE		1-9	\$244.12	10-24	\$231.91	25-49	\$219.71	50+	\$209.94	 <table border="1"> <thead> <tr> <th colspan="2">PRICE</th> </tr> </thead> <tbody> <tr> <td>1-24</td> <td>\$92.46</td> </tr> <tr> <td>25-49</td> <td>\$87.84</td> </tr> <tr> <td>50-99</td> <td>\$83.21</td> </tr> <tr> <td>NEW 100+</td> <td>\$79.52</td> </tr> </tbody> </table> <p>SMA Male to HN Male VSWR 1.4:1 to 4 GHz</p> <p>Model No: PE91448</p>	PRICE		1-24	\$92.46	25-49	\$87.84	50-99	\$83.21	NEW 100+	\$79.52	 <table border="1"> <thead> <tr> <th colspan="2">PRICE</th> </tr> </thead> <tbody> <tr> <td>1-9</td> <td>\$138.57</td> </tr> <tr> <td>10-24</td> <td>\$131.64</td> </tr> <tr> <td>25-49</td> <td>\$124.71</td> </tr> <tr> <td>50+</td> <td>\$119.17</td> </tr> </tbody> </table> <p>SMA Male to HN Female</p> <p>Model No: PE9256</p>	PRICE		1-9	\$138.57	10-24	\$131.64	25-49	\$124.71	50+	\$119.17	 <table border="1"> <thead> <tr> <th colspan="2">PRICE</th> </tr> </thead> <tbody> <tr> <td>1-24</td> <td>\$113.69</td> </tr> <tr> <td>25-49</td> <td>\$108.01</td> </tr> <tr> <td>50-99</td> <td>\$102.32</td> </tr> <tr> <td>100+</td> <td>\$97.77</td> </tr> </tbody> </table> <p>SMA Male to MCX Plug</p> <p>Model No: PE9473</p>	PRICE		1-24	\$113.69	25-49	\$108.01	50-99	\$102.32	100+	\$97.77
	PRICE																																																						
1-24	\$23.07																																																						
25-49	\$21.92																																																						
50-99	\$20.76																																																						
100+	\$19.84																																																						
PRICE																																																							
1-9	\$244.12																																																						
10-24	\$231.91																																																						
25-49	\$219.71																																																						
50+	\$209.94																																																						
PRICE																																																							
1-24	\$92.46																																																						
25-49	\$87.84																																																						
50-99	\$83.21																																																						
NEW 100+	\$79.52																																																						
PRICE																																																							
1-9	\$138.57																																																						
10-24	\$131.64																																																						
25-49	\$124.71																																																						
50+	\$119.17																																																						
PRICE																																																							
1-24	\$113.69																																																						
25-49	\$108.01																																																						
50-99	\$102.32																																																						
100+	\$97.77																																																						
2	 <table border="1"> <thead> <tr> <th colspan="2">PRICE</th> </tr> </thead> <tbody> <tr> <td>1-24</td> <td>\$104.58</td> </tr> <tr> <td>25-49</td> <td>\$99.35</td> </tr> <tr> <td>50-99</td> <td>\$94.12</td> </tr> <tr> <td>100+</td> <td>\$89.94</td> </tr> </tbody> </table> <p>SMA Male to MCX Jack</p> <p>Model No: PE9472</p>	PRICE		1-24	\$104.58	25-49	\$99.35	50-99	\$94.12	100+	\$89.94	 <table border="1"> <thead> <tr> <th colspan="2">PRICE</th> </tr> </thead> <tbody> <tr> <td>1-24</td> <td>\$89.02</td> </tr> <tr> <td>25-49</td> <td>\$84.57</td> </tr> <tr> <td>50-99</td> <td>\$80.12</td> </tr> <tr> <td>100+</td> <td>\$76.56</td> </tr> </tbody> </table> <p>SMA Male to Full Detent Mini SMP Male VSWR 1.2:1 to 18 GHz</p> <p>Model No: PE91302</p>	PRICE		1-24	\$89.02	25-49	\$84.57	50-99	\$80.12	100+	\$76.56	 <table border="1"> <thead> <tr> <th colspan="2">PRICE</th> </tr> </thead> <tbody> <tr> <td>1-24</td> <td>\$100.77</td> </tr> <tr> <td>25-49</td> <td>\$95.73</td> </tr> <tr> <td>50-99</td> <td>\$90.69</td> </tr> <tr> <td>100+</td> <td>\$86.66</td> </tr> </tbody> </table> <p>SMA Male to Smooth Bore Mini SMP Male VSWR 1.2:1 to 18 GHz</p> <p>Model No: PE91303</p>	PRICE		1-24	\$100.77	25-49	\$95.73	50-99	\$90.69	100+	\$86.66	 <table border="1"> <thead> <tr> <th colspan="2">PRICE</th> </tr> </thead> <tbody> <tr> <td>1-9</td> <td>\$191.34</td> </tr> <tr> <td>10-24</td> <td>\$181.77</td> </tr> <tr> <td>25-49</td> <td>\$172.21</td> </tr> <tr> <td>PRECISION 50+</td> <td>\$164.55</td> </tr> </tbody> </table> <p>SMA Male to Full Detent Mini SMP Male VSWR 1.2:1 to 26.5 GHz</p> <p>Model No: PE91052</p>	PRICE		1-9	\$191.34	10-24	\$181.77	25-49	\$172.21	PRECISION 50+	\$164.55	 <table border="1"> <thead> <tr> <th colspan="2">PRICE</th> </tr> </thead> <tbody> <tr> <td>1-24</td> <td>\$90.69</td> </tr> <tr> <td>25-49</td> <td>\$86.16</td> </tr> <tr> <td>50-99</td> <td>\$81.62</td> </tr> <tr> <td>100+</td> <td>\$77.99</td> </tr> </tbody> </table> <p>SMA Male to Mini SMP Female VSWR 1.2:1 to 18 GHz</p> <p>Model No: PE91304</p>	PRICE		1-24	\$90.69	25-49	\$86.16	50-99	\$81.62	100+	\$77.99
	PRICE																																																						
1-24	\$104.58																																																						
25-49	\$99.35																																																						
50-99	\$94.12																																																						
100+	\$89.94																																																						
PRICE																																																							
1-24	\$89.02																																																						
25-49	\$84.57																																																						
50-99	\$80.12																																																						
100+	\$76.56																																																						
PRICE																																																							
1-24	\$100.77																																																						
25-49	\$95.73																																																						
50-99	\$90.69																																																						
100+	\$86.66																																																						
PRICE																																																							
1-9	\$191.34																																																						
10-24	\$181.77																																																						
25-49	\$172.21																																																						
PRECISION 50+	\$164.55																																																						
PRICE																																																							
1-24	\$90.69																																																						
25-49	\$86.16																																																						
50-99	\$81.62																																																						
100+	\$77.99																																																						
3	 <table border="1"> <thead> <tr> <th colspan="2">PRICE</th> </tr> </thead> <tbody> <tr> <td>1-9</td> <td>\$229.85</td> </tr> <tr> <td>10-24</td> <td>\$218.36</td> </tr> <tr> <td>25-49</td> <td>\$206.87</td> </tr> <tr> <td>PRECISION 50+</td> <td>\$197.67</td> </tr> </tbody> </table> <p>SMA Male to Mini SMP Female VSWR 1.2:1 to 26.5 GHz</p> <p>Model No: PE91103</p>	PRICE		1-9	\$229.85	10-24	\$218.36	25-49	\$206.87	PRECISION 50+	\$197.67	 <table border="1"> <thead> <tr> <th colspan="2">PRICE</th> </tr> </thead> <tbody> <tr> <td>1-9</td> <td>\$127.83</td> </tr> <tr> <td>10-24</td> <td>\$121.44</td> </tr> <tr> <td>25-49</td> <td>\$115.05</td> </tr> <tr> <td>50+</td> <td>\$109.93</td> </tr> </tbody> </table> <p>SMA Male to MMCX Plug</p> <p>Model No: PE9476</p>	PRICE		1-9	\$127.83	10-24	\$121.44	25-49	\$115.05	50+	\$109.93	 <table border="1"> <thead> <tr> <th colspan="2">PRICE</th> </tr> </thead> <tbody> <tr> <td>1-24</td> <td>\$94.99</td> </tr> <tr> <td>25-49</td> <td>\$90.24</td> </tr> <tr> <td>50-99</td> <td>\$85.49</td> </tr> <tr> <td>100+</td> <td>\$81.69</td> </tr> </tbody> </table> <p>SMA Male to MMCX Jack</p> <p>Model No: PE9478</p>	PRICE		1-24	\$94.99	25-49	\$90.24	50-99	\$85.49	100+	\$81.69	 <table border="1"> <thead> <tr> <th colspan="2">PRICE</th> </tr> </thead> <tbody> <tr> <td>1-9</td> <td>\$201.74</td> </tr> <tr> <td>10-24</td> <td>\$191.65</td> </tr> <tr> <td>25-49</td> <td>\$181.57</td> </tr> <tr> <td>NEW 50+</td> <td>\$173.50</td> </tr> </tbody> </table> <p>SMA Male to Snap-On MMBX Plug VSWR 1.2:1 to 12.4 GHz</p> <p>Model No: PE91360</p>	PRICE		1-9	\$201.74	10-24	\$191.65	25-49	\$181.57	NEW 50+	\$173.50	 <table border="1"> <thead> <tr> <th colspan="2">PRICE</th> </tr> </thead> <tbody> <tr> <td>1-9</td> <td>\$184.80</td> </tr> <tr> <td>10-24</td> <td>\$175.56</td> </tr> <tr> <td>25-49</td> <td>\$166.32</td> </tr> <tr> <td>NEW 50+</td> <td>\$158.93</td> </tr> </tbody> </table> <p>SMA Male to Snap-On MMBX Jack VSWR 1.08:1 to 12.4 GHz</p> <p>Model No: PE91362</p>	PRICE		1-9	\$184.80	10-24	\$175.56	25-49	\$166.32	NEW 50+	\$158.93
	PRICE																																																						
1-9	\$229.85																																																						
10-24	\$218.36																																																						
25-49	\$206.87																																																						
PRECISION 50+	\$197.67																																																						
PRICE																																																							
1-9	\$127.83																																																						
10-24	\$121.44																																																						
25-49	\$115.05																																																						
50+	\$109.93																																																						
PRICE																																																							
1-24	\$94.99																																																						
25-49	\$90.24																																																						
50-99	\$85.49																																																						
100+	\$81.69																																																						
PRICE																																																							
1-9	\$201.74																																																						
10-24	\$191.65																																																						
25-49	\$181.57																																																						
NEW 50+	\$173.50																																																						
PRICE																																																							
1-9	\$184.80																																																						
10-24	\$175.56																																																						
25-49	\$166.32																																																						
NEW 50+	\$158.93																																																						
4	 <table border="1"> <thead> <tr> <th colspan="2">PRICE</th> </tr> </thead> <tbody> <tr> <td>1-24</td> <td>\$24.38</td> </tr> <tr> <td>25-49</td> <td>\$23.16</td> </tr> <tr> <td>50-99</td> <td>\$21.94</td> </tr> <tr> <td>100+</td> <td>\$20.97</td> </tr> </tbody> </table> <p>SMA Male to N Male VSWR 1.3:1 to 11 GHz</p> <p>Model No: PE9080</p>	PRICE		1-24	\$24.38	25-49	\$23.16	50-99	\$21.94	100+	\$20.97	 <table border="1"> <thead> <tr> <th colspan="2">PRICE</th> </tr> </thead> <tbody> <tr> <td>1-9</td> <td>\$138.42</td> </tr> <tr> <td>10-24</td> <td>\$131.50</td> </tr> <tr> <td>25-49</td> <td>\$124.58</td> </tr> <tr> <td>PRECISION 50+</td> <td>\$119.04</td> </tr> </tbody> </table> <p>SMA Male to N Male VSWR 1.15:1 to 18 GHz</p> <p>Model No: PE9431</p>	PRICE		1-9	\$138.42	10-24	\$131.50	25-49	\$124.58	PRECISION 50+	\$119.04	 <table border="1"> <thead> <tr> <th colspan="2">PRICE</th> </tr> </thead> <tbody> <tr> <td>1-9</td> <td>\$142.70</td> </tr> <tr> <td>10-24</td> <td>\$135.57</td> </tr> <tr> <td>25-49</td> <td>\$128.43</td> </tr> <tr> <td>PRECISION 50+</td> <td>\$122.72</td> </tr> </tbody> </table> <p>SMA Male to N Male 4 Hole Flange-Mounting Hole A05 VSWR 1.15:1 to 18 GHz</p> <p>Model No: PE9499</p>	PRICE		1-9	\$142.70	10-24	\$135.57	25-49	\$128.43	PRECISION 50+	\$122.72	 <table border="1"> <thead> <tr> <th colspan="2">PRICE</th> </tr> </thead> <tbody> <tr> <td>1-24</td> <td>\$22.87</td> </tr> <tr> <td>25-49</td> <td>\$21.73</td> </tr> <tr> <td>50-99</td> <td>\$20.58</td> </tr> <tr> <td>100+</td> <td>\$19.67</td> </tr> </tbody> </table> <p>SMA Male to N Female VSWR 1.3:1 to 11 GHz</p> <p>Model No: PE9082</p>	PRICE		1-24	\$22.87	25-49	\$21.73	50-99	\$20.58	100+	\$19.67	 <table border="1"> <thead> <tr> <th colspan="2">PRICE</th> </tr> </thead> <tbody> <tr> <td>1-24</td> <td>\$102.64</td> </tr> <tr> <td>25-49</td> <td>\$97.51</td> </tr> <tr> <td>50-99</td> <td>\$92.38</td> </tr> <tr> <td>PRECISION 100+</td> <td>\$88.27</td> </tr> </tbody> </table> <p>SMA Male to N Female VSWR 1.15:1 to 18 GHz</p> <p>Model No: PE9433</p>	PRICE		1-24	\$102.64	25-49	\$97.51	50-99	\$92.38	PRECISION 100+	\$88.27
	PRICE																																																						
1-24	\$24.38																																																						
25-49	\$23.16																																																						
50-99	\$21.94																																																						
100+	\$20.97																																																						
PRICE																																																							
1-9	\$138.42																																																						
10-24	\$131.50																																																						
25-49	\$124.58																																																						
PRECISION 50+	\$119.04																																																						
PRICE																																																							
1-9	\$142.70																																																						
10-24	\$135.57																																																						
25-49	\$128.43																																																						
PRECISION 50+	\$122.72																																																						
PRICE																																																							
1-24	\$22.87																																																						
25-49	\$21.73																																																						
50-99	\$20.58																																																						
100+	\$19.67																																																						
PRICE																																																							
1-24	\$102.64																																																						
25-49	\$97.51																																																						
50-99	\$92.38																																																						
PRECISION 100+	\$88.27																																																						
5	 <table border="1"> <thead> <tr> <th colspan="2">PRICE</th> </tr> </thead> <tbody> <tr> <td>1-9</td> <td>\$184.89</td> </tr> <tr> <td>10-24</td> <td>\$175.65</td> </tr> <tr> <td>25-49</td> <td>\$166.40</td> </tr> <tr> <td>PRECISION 50+</td> <td>\$159.01</td> </tr> </tbody> </table> <p>SMA Male to N Female Bulkhead VSWR 1.15:1 to 18 GHz</p> <p>Model No: PE9487</p>	PRICE		1-9	\$184.89	10-24	\$175.65	25-49	\$166.40	PRECISION 50+	\$159.01	 <table border="1"> <thead> <tr> <th colspan="2">PRICE</th> </tr> </thead> <tbody> <tr> <td>1-24</td> <td>\$101.91</td> </tr> <tr> <td>25-49</td> <td>\$96.81</td> </tr> <tr> <td>50-99</td> <td>\$91.72</td> </tr> <tr> <td>100+</td> <td>\$87.64</td> </tr> </tbody> </table> <p>SMA Male to N Female 4 Hole Flange VSWR 1.4:1 to 18 GHz</p> <p>Model No: PE9105</p>	PRICE		1-24	\$101.91	25-49	\$96.81	50-99	\$91.72	100+	\$87.64	 <table border="1"> <thead> <tr> <th colspan="2">PRICE</th> </tr> </thead> <tbody> <tr> <td>1-9</td> <td>\$196.20</td> </tr> <tr> <td>10-24</td> <td>\$186.39</td> </tr> <tr> <td>25-49</td> <td>\$176.58</td> </tr> <tr> <td>PRECISION 50+</td> <td>\$168.73</td> </tr> </tbody> </table> <p>SMA Male to N Female 4 Hole Flange VSWR 1.15:1 to 18 GHz</p> <p>Model No: PE9497</p>	PRICE		1-9	\$196.20	10-24	\$186.39	25-49	\$176.58	PRECISION 50+	\$168.73	 <table border="1"> <thead> <tr> <th colspan="2">PRICE</th> </tr> </thead> <tbody> <tr> <td>1-9</td> <td>\$179.17</td> </tr> <tr> <td>10-24</td> <td>\$170.21</td> </tr> <tr> <td>25-49</td> <td>\$161.25</td> </tr> <tr> <td>PRECISION 50+</td> <td>\$154.09</td> </tr> </tbody> </table> <p>SMA Male to N Female Bulkhead VSWR 1.15:1 to 18 GHz</p> <p>Model No: PE9488</p>	PRICE		1-9	\$179.17	10-24	\$170.21	25-49	\$161.25	PRECISION 50+	\$154.09	 <table border="1"> <thead> <tr> <th colspan="2">PRICE</th> </tr> </thead> <tbody> <tr> <td>1-24</td> <td>\$23.02</td> </tr> <tr> <td>25-49</td> <td>\$22.10</td> </tr> <tr> <td>50-99</td> <td>\$21.41</td> </tr> <tr> <td>NEW 100+</td> <td>\$20.95</td> </tr> </tbody> </table> <p>Push-On SMA Male to SMA Female VSWR 1.5:1 to 18 GHz</p> <p>Model No: PE91336</p>	PRICE		1-24	\$23.02	25-49	\$22.10	50-99	\$21.41	NEW 100+	\$20.95
	PRICE																																																						
1-9	\$184.89																																																						
10-24	\$175.65																																																						
25-49	\$166.40																																																						
PRECISION 50+	\$159.01																																																						
PRICE																																																							
1-24	\$101.91																																																						
25-49	\$96.81																																																						
50-99	\$91.72																																																						
100+	\$87.64																																																						
PRICE																																																							
1-9	\$196.20																																																						
10-24	\$186.39																																																						
25-49	\$176.58																																																						
PRECISION 50+	\$168.73																																																						
PRICE																																																							
1-9	\$179.17																																																						
10-24	\$170.21																																																						
25-49	\$161.25																																																						
PRECISION 50+	\$154.09																																																						
PRICE																																																							
1-24	\$23.02																																																						
25-49	\$22.10																																																						
50-99	\$21.41																																																						
NEW 100+	\$20.95																																																						
6	 <table border="1"> <thead> <tr> <th colspan="2">PRICE</th> </tr> </thead> <tbody> <tr> <td>1-24</td> <td>\$88.98</td> </tr> <tr> <td>25-49</td> <td>\$84.53</td> </tr> <tr> <td>50-99</td> <td>\$80.08</td> </tr> <tr> <td>100+</td> <td>\$76.52</td> </tr> </tbody> </table> <p>SMA Male to SMB Plug VSWR 1.25:1 to 4 GHz</p> <p>Model No: PE9144</p>	PRICE		1-24	\$88.98	25-49	\$84.53	50-99	\$80.08	100+	\$76.52	 <table border="1"> <thead> <tr> <th colspan="2">PRICE</th> </tr> </thead> <tbody> <tr> <td>1-24</td> <td>\$50.68</td> </tr> <tr> <td>25-49</td> <td>\$48.15</td> </tr> <tr> <td>50-99</td> <td>\$45.61</td> </tr> <tr> <td>100+</td> <td>\$43.58</td> </tr> </tbody> </table> <p>SMA Male to SMB Jack VSWR 1.25:1 to 4 GHz</p> <p>Model No: PE9145</p>	PRICE		1-24	\$50.68	25-49	\$48.15	50-99	\$45.61	100+	\$43.58	 <table border="1"> <thead> <tr> <th colspan="2">PRICE</th> </tr> </thead> <tbody> <tr> <td>1-24</td> <td>\$70.85</td> </tr> <tr> <td>25-49</td> <td>\$67.31</td> </tr> <tr> <td>50-99</td> <td>\$63.77</td> </tr> <tr> <td>100+</td> <td>\$60.93</td> </tr> </tbody> </table> <p>SMA Male to SMC Plug Max. Freq. 10 GHz</p> <p>Model No: PE9148</p>	PRICE		1-24	\$70.85	25-49	\$67.31	50-99	\$63.77	100+	\$60.93	 <table border="1"> <thead> <tr> <th colspan="2">PRICE</th> </tr> </thead> <tbody> <tr> <td>1-24</td> <td>\$60.54</td> </tr> <tr> <td>25-49</td> <td>\$57.51</td> </tr> <tr> <td>50-99</td> <td>\$54.49</td> </tr> <tr> <td>100+</td> <td>\$52.06</td> </tr> </tbody> </table> <p>SMA Male to SMC Jack VSWR 1.2:1 to 10 GHz</p> <p>Model No: PE9149</p>	PRICE		1-24	\$60.54	25-49	\$57.51	50-99	\$54.49	100+	\$52.06	 <table border="1"> <thead> <tr> <th colspan="2">PRICE</th> </tr> </thead> <tbody> <tr> <td>1-24</td> <td>\$71.57</td> </tr> <tr> <td>25-49</td> <td>\$67.99</td> </tr> <tr> <td>50-99</td> <td>\$64.41</td> </tr> <tr> <td>100+</td> <td>\$61.55</td> </tr> </tbody> </table> <p>SMA Male to Full Detent SMP Male VSWR 1.2:1 to 18 GHz</p> <p>Model No: PE91309</p>	PRICE		1-24	\$71.57	25-49	\$67.99	50-99	\$64.41	100+	\$61.55
	PRICE																																																						
1-24	\$88.98																																																						
25-49	\$84.53																																																						
50-99	\$80.08																																																						
100+	\$76.52																																																						
PRICE																																																							
1-24	\$50.68																																																						
25-49	\$48.15																																																						
50-99	\$45.61																																																						
100+	\$43.58																																																						
PRICE																																																							
1-24	\$70.85																																																						
25-49	\$67.31																																																						
50-99	\$63.77																																																						
100+	\$60.93																																																						
PRICE																																																							
1-24	\$60.54																																																						
25-49	\$57.51																																																						
50-99	\$54.49																																																						
100+	\$52.06																																																						
PRICE																																																							
1-24	\$71.57																																																						
25-49	\$67.99																																																						
50-99	\$64.41																																																						
100+	\$61.55																																																						
7	 <table border="1"> <thead> <tr> <th colspan="2">PRICE</th> </tr> </thead> <tbody> <tr> <td>1-24</td> <td>\$70.27</td> </tr> <tr> <td>25-49</td> <td>\$66.76</td> </tr> <tr> <td>50-99</td> <td>\$63.24</td> </tr> <tr> <td>100+</td> <td>\$60.43</td> </tr> </tbody> </table> <p>SMA Male to Limited Detent SMP Male VSWR 1.2:1 to 18 GHz</p> <p>Model No: PE91310</p>	PRICE		1-24	\$70.27	25-49	\$66.76	50-99	\$63.24	100+	\$60.43	 <table border="1"> <thead> <tr> <th colspan="2">PRICE</th> </tr> </thead> <tbody> <tr> <td>1-24</td> <td>\$70.27</td> </tr> <tr> <td>25-49</td> <td>\$66.76</td> </tr> <tr> <td>50-99</td> <td>\$63.24</td> </tr> <tr> <td>100+</td> <td>\$60.43</td> </tr> </tbody> </table> <p>SMA Male to Smooth Bore SMP Male VSWR 1.2:1 to 18 GHz</p> <p>Model No: PE91311</p>	PRICE		1-24	\$70.27	25-49	\$66.76	50-99	\$63.24	100+	\$60.43	 <table border="1"> <thead> <tr> <th colspan="2">PRICE</th> </tr> </thead> <tbody> <tr> <td>1-9</td> <td>\$126.71</td> </tr> <tr> <td>10-24</td> <td>\$120.37</td> </tr> <tr> <td>25-49</td> <td>\$114.04</td> </tr> <tr> <td>PRECISION 50+</td> <td>\$108.97</td> </tr> </tbody> </table> <p>SMA Male to Full Detent SMP Male VSWR 1.2:1 to 26.5 GHz</p> <p>Model No: PE91063</p>	PRICE		1-9	\$126.71	10-24	\$120.37	25-49	\$114.04	PRECISION 50+	\$108.97	 <table border="1"> <thead> <tr> <th colspan="2">PRICE</th> </tr> </thead> <tbody> <tr> <td>1-9</td> <td>\$167.87</td> </tr> <tr> <td>10-24</td> <td>\$159.48</td> </tr> <tr> <td>25-49</td> <td>\$151.08</td> </tr> <tr> <td>PRECISION 50+</td> <td>\$144.37</td> </tr> </tbody> </table> <p>SMA Male to Limited Detent SMP Male VSWR 1.2:1 to 18 GHz</p> <p>Model No: PE9511</p>	PRICE		1-9	\$167.87	10-24	\$159.48	25-49	\$151.08	PRECISION 50+	\$144.37	 <table border="1"> <thead> <tr> <th colspan="2">PRICE</th> </tr> </thead> <tbody> <tr> <td>1-24</td> <td>\$71.57</td> </tr> <tr> <td>25-49</td> <td>\$67.99</td> </tr> <tr> <td>50-99</td> <td>\$64.41</td> </tr> <tr> <td>100+</td> <td>\$61.55</td> </tr> </tbody> </table> <p>SMA Male to SMP Female VSWR 1.2:1 to 18 GHz</p> <p>Model No: PE91312</p>	PRICE		1-24	\$71.57	25-49	\$67.99	50-99	\$64.41	100+	\$61.55
	PRICE																																																						
1-24	\$70.27																																																						
25-49	\$66.76																																																						
50-99	\$63.24																																																						
100+	\$60.43																																																						
PRICE																																																							
1-24	\$70.27																																																						
25-49	\$66.76																																																						
50-99	\$63.24																																																						
100+	\$60.43																																																						
PRICE																																																							
1-9	\$126.71																																																						
10-24	\$120.37																																																						
25-49	\$114.04																																																						
PRECISION 50+	\$108.97																																																						
PRICE																																																							
1-9	\$167.87																																																						
10-24	\$159.48																																																						
25-49	\$151.08																																																						
PRECISION 50+	\$144.37																																																						
PRICE																																																							
1-24	\$71.57																																																						
25-49	\$67.99																																																						
50-99	\$64.41																																																						
100+	\$61.55																																																						

ADAPTERS

See Adapter Locator on Pages 8-13

See Page 369 for Mounting Holes

	A	B	C	D	E																									
1	 <table border="1"> <thead> <tr> <th>PRICE</th> </tr> </thead> <tbody> <tr> <td>1-9 \$157.28</td> </tr> <tr> <td>10-24 \$149.42</td> </tr> <tr> <td>25-49 \$141.55</td> </tr> <tr> <td>50+ \$135.26</td> </tr> </tbody> </table> <p>PRECISION</p> <p>SMA Male to SMP Female</p> <p>VSWR 1.2:1 to 26.5 GHz</p> <p>Model No: PE91062</p>	PRICE	1-9 \$157.28	10-24 \$149.42	25-49 \$141.55	50+ \$135.26	 <table border="1"> <thead> <tr> <th>PRICE</th> </tr> </thead> <tbody> <tr> <td>1-9 \$192.04</td> </tr> <tr> <td>10-24 \$182.44</td> </tr> <tr> <td>25-49 \$172.84</td> </tr> <tr> <td>50+ \$165.15</td> </tr> </tbody> </table> <p>PRECISION</p> <p>SMA Male to SMP Female</p> <p>VSWR 1.2:1 to 18 GHz</p> <p>Model No: PE9513</p>	PRICE	1-9 \$192.04	10-24 \$182.44	25-49 \$172.84	50+ \$165.15	 <table border="1"> <thead> <tr> <th>PRICE</th> </tr> </thead> <tbody> <tr> <td>1-24 \$100.70</td> </tr> <tr> <td>25-49 \$95.67</td> </tr> <tr> <td>50-99 \$90.63</td> </tr> <tr> <td>100+ \$86.60</td> </tr> </tbody> </table> <p>SMA Male to SSMA Male</p> <p>VSWR 1.25:1 to 26.5 GHz</p> <p>Model No: PE9187</p>	PRICE	1-24 \$100.70	25-49 \$95.67	50-99 \$90.63	100+ \$86.60	 <table border="1"> <thead> <tr> <th>PRICE</th> </tr> </thead> <tbody> <tr> <td>1-24 \$64.77</td> </tr> <tr> <td>25-49 \$61.53</td> </tr> <tr> <td>50-99 \$58.29</td> </tr> <tr> <td>100+ \$55.70</td> </tr> </tbody> </table> <p>SMA Male to SSMA Female</p> <p>VSWR 1.4:1 to 18 GHz</p> <p>Model No: PE9063</p>	PRICE	1-24 \$64.77	25-49 \$61.53	50-99 \$58.29	100+ \$55.70	 <table border="1"> <thead> <tr> <th>PRICE</th> </tr> </thead> <tbody> <tr> <td>1-24 \$89.29</td> </tr> <tr> <td>25-49 \$84.83</td> </tr> <tr> <td>50-99 \$80.36</td> </tr> <tr> <td>100+ \$76.79</td> </tr> </tbody> </table> <p>SMA Male to SSMB Jack</p> <p>Model No: PE9401</p>	PRICE	1-24 \$89.29	25-49 \$84.83	50-99 \$80.36	100+ \$76.79
	PRICE																													
1-9 \$157.28																														
10-24 \$149.42																														
25-49 \$141.55																														
50+ \$135.26																														
PRICE																														
1-9 \$192.04																														
10-24 \$182.44																														
25-49 \$172.84																														
50+ \$165.15																														
PRICE																														
1-24 \$100.70																														
25-49 \$95.67																														
50-99 \$90.63																														
100+ \$86.60																														
PRICE																														
1-24 \$64.77																														
25-49 \$61.53																														
50-99 \$58.29																														
100+ \$55.70																														
PRICE																														
1-24 \$89.29																														
25-49 \$84.83																														
50-99 \$80.36																														
100+ \$76.79																														
2	 <table border="1"> <thead> <tr> <th>PRICE</th> </tr> </thead> <tbody> <tr> <td>1-24 \$43.86</td> </tr> <tr> <td>25-49 \$41.67</td> </tr> <tr> <td>50-99 \$39.47</td> </tr> <tr> <td>100+ \$37.72</td> </tr> </tbody> </table> <p>SMA Male to TNC Male</p> <p>Model No: PE9076</p>	PRICE	1-24 \$43.86	25-49 \$41.67	50-99 \$39.47	100+ \$37.72	 <table border="1"> <thead> <tr> <th>PRICE</th> </tr> </thead> <tbody> <tr> <td>1-9 \$137.52</td> </tr> <tr> <td>10-24 \$130.64</td> </tr> <tr> <td>25-49 \$123.77</td> </tr> <tr> <td>50+ \$118.27</td> </tr> </tbody> </table> <p>SMA Male to TNC Male</p> <p>VSWR 1.25:1 to 18 GHz</p> <p>Model No: PE9439</p>	PRICE	1-9 \$137.52	10-24 \$130.64	25-49 \$123.77	50+ \$118.27	 <table border="1"> <thead> <tr> <th>PRICE</th> </tr> </thead> <tbody> <tr> <td>1-24 \$44.53</td> </tr> <tr> <td>25-49 \$42.30</td> </tr> <tr> <td>50-99 \$40.08</td> </tr> <tr> <td>100+ \$38.30</td> </tr> </tbody> </table> <p>SMA Male to TNC Female</p> <p>VSWR 1.3:1 to 11 GHz</p> <p>Model No: PE9078</p>	PRICE	1-24 \$44.53	25-49 \$42.30	50-99 \$40.08	100+ \$38.30	<p>Ohm SMA Between Series</p> <p>→</p>		 <table border="1"> <thead> <tr> <th>PRICE</th> </tr> </thead> <tbody> <tr> <td>1-24 \$110.13</td> </tr> <tr> <td>25-49 \$102.42</td> </tr> <tr> <td>50-99 \$94.71</td> </tr> <tr> <td>100+ \$88.10</td> </tr> </tbody> </table> <p>SMA Male to TNC Female</p> <p>VSWR 1.2:1 to 18 GHz</p> <p>Model No: PE91507</p>	PRICE	1-24 \$110.13	25-49 \$102.42	50-99 \$94.71	100+ \$88.10				
	PRICE																													
1-24 \$43.86																														
25-49 \$41.67																														
50-99 \$39.47																														
100+ \$37.72																														
PRICE																														
1-9 \$137.52																														
10-24 \$130.64																														
25-49 \$123.77																														
50+ \$118.27																														
PRICE																														
1-24 \$44.53																														
25-49 \$42.30																														
50-99 \$40.08																														
100+ \$38.30																														
PRICE																														
1-24 \$110.13																														
25-49 \$102.42																														
50-99 \$94.71																														
100+ \$88.10																														
3	<p>SMA Between Series</p> <p>→</p>		 <table border="1"> <thead> <tr> <th>PRICE</th> </tr> </thead> <tbody> <tr> <td>1-24 \$95.43</td> </tr> <tr> <td>25-49 \$90.66</td> </tr> <tr> <td>50-99 \$85.89</td> </tr> <tr> <td>100+ \$82.07</td> </tr> </tbody> </table> <p>SMA Male to TNC Female 4 Hole Flange-Mounting Hole A04</p> <p>VSWR 1.3:1 to 11 GHz</p> <p>Model No: PE9384</p>	PRICE	1-24 \$95.43	25-49 \$90.66	50-99 \$85.89	100+ \$82.07	 <table border="1"> <thead> <tr> <th>PRICE</th> </tr> </thead> <tbody> <tr> <td>1-24 \$48.24</td> </tr> <tr> <td>25-49 \$45.83</td> </tr> <tr> <td>50-99 \$43.42</td> </tr> <tr> <td>100+ \$41.49</td> </tr> </tbody> </table> <p>SMA Male to UHF Female</p> <p>Model No: PE9400</p>	PRICE	1-24 \$48.24	25-49 \$45.83	50-99 \$43.42	100+ \$41.49	 <table border="1"> <thead> <tr> <th>PRICE</th> </tr> </thead> <tbody> <tr> <td>1-24 \$30.20</td> </tr> <tr> <td>25-49 \$28.69</td> </tr> <tr> <td>50-99 \$27.18</td> </tr> <tr> <td>100+ \$25.97</td> </tr> </tbody> </table> <p>SMA Male to UMCX Jack</p> <p>VSWR 1.3:1 to 6 GHz</p> <p>Model No: PE91007</p>	PRICE	1-24 \$30.20	25-49 \$28.69	50-99 \$27.18	100+ \$25.97	 <table border="1"> <thead> <tr> <th>PRICE</th> </tr> </thead> <tbody> <tr> <td>1-24 \$97.00</td> </tr> <tr> <td>25-49 \$92.15</td> </tr> <tr> <td>50-99 \$87.30</td> </tr> <tr> <td>100+ \$83.42</td> </tr> </tbody> </table> <p>SMA Female to 1.0/2.3 Plug</p> <p>Model No: PE9691</p>	PRICE	1-24 \$97.00	25-49 \$92.15	50-99 \$87.30	100+ \$83.42				
	PRICE																													
1-24 \$95.43																														
25-49 \$90.66																														
50-99 \$85.89																														
100+ \$82.07																														
PRICE																														
1-24 \$48.24																														
25-49 \$45.83																														
50-99 \$43.42																														
100+ \$41.49																														
PRICE																														
1-24 \$30.20																														
25-49 \$28.69																														
50-99 \$27.18																														
100+ \$25.97																														
PRICE																														
1-24 \$97.00																														
25-49 \$92.15																														
50-99 \$87.30																														
100+ \$83.42																														
4	 <table border="1"> <thead> <tr> <th>PRICE</th> </tr> </thead> <tbody> <tr> <td>1-24 \$84.56</td> </tr> <tr> <td>25-49 \$80.33</td> </tr> <tr> <td>50-99 \$76.10</td> </tr> <tr> <td>100+ \$72.72</td> </tr> </tbody> </table> <p>SMA Female to 1.0/2.3 Jack</p> <p>Model No: PE9693</p>	PRICE	1-24 \$84.56	25-49 \$80.33	50-99 \$76.10	100+ \$72.72	 <table border="1"> <thead> <tr> <th>PRICE</th> </tr> </thead> <tbody> <tr> <td>1-9 \$210.40</td> </tr> <tr> <td>10-24 \$199.88</td> </tr> <tr> <td>25-49 \$189.36</td> </tr> <tr> <td>50+ \$180.94</td> </tr> </tbody> </table> <p>SMA Female to 1.85mm Male</p> <p>VSWR 1.3:1 to 18 GHz</p> <p>Model No: PE9726</p>	PRICE	1-9 \$210.40	10-24 \$199.88	25-49 \$189.36	50+ \$180.94	 <table border="1"> <thead> <tr> <th>PRICE</th> </tr> </thead> <tbody> <tr> <td>1-9 \$217.27</td> </tr> <tr> <td>10-24 \$206.41</td> </tr> <tr> <td>25-49 \$195.54</td> </tr> <tr> <td>50+ \$186.85</td> </tr> </tbody> </table> <p>SMA Female to 1.85mm Female</p> <p>VSWR 1.3:1 to 18 GHz</p> <p>Model No: PE9729</p>	PRICE	1-9 \$217.27	10-24 \$206.41	25-49 \$195.54	50+ \$186.85	 <table border="1"> <thead> <tr> <th>PRICE</th> </tr> </thead> <tbody> <tr> <td>1-9 \$214.32</td> </tr> <tr> <td>10-24 \$203.60</td> </tr> <tr> <td>25-49 \$192.89</td> </tr> <tr> <td>50+ \$184.32</td> </tr> </tbody> </table> <p>SMA Female to 2.4mm Male</p> <p>VSWR 1.2:1 to 27 GHz</p> <p>Model No: PE9655</p>	PRICE	1-9 \$214.32	10-24 \$203.60	25-49 \$192.89	50+ \$184.32	 <table border="1"> <thead> <tr> <th>PRICE</th> </tr> </thead> <tbody> <tr> <td>1-9 \$220.01</td> </tr> <tr> <td>10-24 \$209.01</td> </tr> <tr> <td>25-49 \$198.01</td> </tr> <tr> <td>50+ \$189.21</td> </tr> </tbody> </table> <p>PRECISION</p> <p>SMA Female to 2.4mm Female</p> <p>VSWR 1.2:1 to 26.5 GHz</p> <p>Model No: PE9656</p>	PRICE	1-9 \$220.01	10-24 \$209.01	25-49 \$198.01	50+ \$189.21
	PRICE																													
1-24 \$84.56																														
25-49 \$80.33																														
50-99 \$76.10																														
100+ \$72.72																														
PRICE																														
1-9 \$210.40																														
10-24 \$199.88																														
25-49 \$189.36																														
50+ \$180.94																														
PRICE																														
1-9 \$217.27																														
10-24 \$206.41																														
25-49 \$195.54																														
50+ \$186.85																														
PRICE																														
1-9 \$214.32																														
10-24 \$203.60																														
25-49 \$192.89																														
50+ \$184.32																														
PRICE																														
1-9 \$220.01																														
10-24 \$209.01																														
25-49 \$198.01																														
50+ \$189.21																														
5	 <table border="1"> <thead> <tr> <th>PRICE</th> </tr> </thead> <tbody> <tr> <td>1-9 \$207.05</td> </tr> <tr> <td>10-24 \$196.70</td> </tr> <tr> <td>25-49 \$186.35</td> </tr> <tr> <td>50+ \$178.06</td> </tr> </tbody> </table> <p>PRECISION</p> <p>SMA Female to 2.92mm Male</p> <p>VSWR 1.2:1 to 26.5 GHz</p> <p>Model No: PE91009</p>	PRICE	1-9 \$207.05	10-24 \$196.70	25-49 \$186.35	50+ \$178.06	 <table border="1"> <thead> <tr> <th>PRICE</th> </tr> </thead> <tbody> <tr> <td>1-9 \$211.08</td> </tr> <tr> <td>10-24 \$200.53</td> </tr> <tr> <td>25-49 \$189.97</td> </tr> <tr> <td>50+ \$181.53</td> </tr> </tbody> </table> <p>PRECISION</p> <p>SMA Female to 2.92mm Female</p> <p>VSWR 1.2:1 to 26.5 GHz</p> <p>Model No: PE91011</p>	PRICE	1-9 \$211.08	10-24 \$200.53	25-49 \$189.97	50+ \$181.53	 <table border="1"> <thead> <tr> <th>PRICE</th> </tr> </thead> <tbody> <tr> <td>1-9 \$193.10</td> </tr> <tr> <td>10-24 \$183.45</td> </tr> <tr> <td>25-49 \$173.79</td> </tr> <tr> <td>50+ \$166.07</td> </tr> </tbody> </table> <p>SMA Female to 3.5mm Male</p> <p>VSWR 1.2:1 to 27 GHz</p> <p>Model No: PE9724</p>	PRICE	1-9 \$193.10	10-24 \$183.45	25-49 \$173.79	50+ \$166.07	 <table border="1"> <thead> <tr> <th>PRICE</th> </tr> </thead> <tbody> <tr> <td>1-9 \$198.70</td> </tr> <tr> <td>10-24 \$188.77</td> </tr> <tr> <td>25-49 \$178.83</td> </tr> <tr> <td>50+ \$170.88</td> </tr> </tbody> </table> <p>SMA Female to 3.5mm Female</p> <p>VSWR 1.2:1 to 27 GHz</p> <p>Model No: PE9725</p>	PRICE	1-9 \$198.70	10-24 \$188.77	25-49 \$178.83	50+ \$170.88	 <table border="1"> <thead> <tr> <th>PRICE</th> </tr> </thead> <tbody> <tr> <td>1-9 \$235.28</td> </tr> <tr> <td>10-24 \$223.52</td> </tr> <tr> <td>25-49 \$211.75</td> </tr> <tr> <td>50+ \$202.34</td> </tr> </tbody> </table> <p>PRECISION</p> <p>SMA Female to 7mm Sexless</p> <p>VSWR 1.15:1 to 18 GHz</p> <p>Model No: PE9214</p>	PRICE	1-9 \$235.28	10-24 \$223.52	25-49 \$211.75	50+ \$202.34
	PRICE																													
1-9 \$207.05																														
10-24 \$196.70																														
25-49 \$186.35																														
50+ \$178.06																														
PRICE																														
1-9 \$211.08																														
10-24 \$200.53																														
25-49 \$189.97																														
50+ \$181.53																														
PRICE																														
1-9 \$193.10																														
10-24 \$183.45																														
25-49 \$173.79																														
50+ \$166.07																														
PRICE																														
1-9 \$198.70																														
10-24 \$188.77																														
25-49 \$178.83																														
50+ \$170.88																														
PRICE																														
1-9 \$235.28																														
10-24 \$223.52																														
25-49 \$211.75																														
50+ \$202.34																														
6	 <table border="1"> <thead> <tr> <th>PRICE</th> </tr> </thead> <tbody> <tr> <td>1-4 \$585.14</td> </tr> <tr> <td>5-9 \$555.88</td> </tr> <tr> <td>10-24 \$526.63</td> </tr> <tr> <td>25+ \$503.22</td> </tr> </tbody> </table> <p>PRECISION</p> <p>SMA Female to 7mm Sexless 4 Hole Flange-Mounting Hole A05</p> <p>VSWR 1.15:1 to 18 GHz</p> <p>Model No: PE9327</p>	PRICE	1-4 \$585.14	5-9 \$555.88	10-24 \$526.63	25+ \$503.22	 <table border="1"> <thead> <tr> <th>PRICE</th> </tr> </thead> <tbody> <tr> <td>1-24 \$90.94</td> </tr> <tr> <td>25-49 \$86.39</td> </tr> <tr> <td>50-99 \$81.85</td> </tr> <tr> <td>100+ \$78.21</td> </tr> </tbody> </table> <p>Low PIM</p> <p>SMA Female to 7/16 DIN Male</p> <p>VSWR 1.09:1 to 7.5 GHz</p> <p>Model No: PE91036</p>	PRICE	1-24 \$90.94	25-49 \$86.39	50-99 \$81.85	100+ \$78.21	 <table border="1"> <thead> <tr> <th>PRICE</th> </tr> </thead> <tbody> <tr> <td>1-9 \$114.30</td> </tr> <tr> <td>10-24 \$108.59</td> </tr> <tr> <td>25-49 \$102.87</td> </tr> <tr> <td>50+ \$98.30</td> </tr> </tbody> </table> <p>SMA Female to 7/16 DIN Male</p> <p>VSWR 1.25:1 to 6 GHz</p> <p>Model No: PE91175</p>	PRICE	1-9 \$114.30	10-24 \$108.59	25-49 \$102.87	50+ \$98.30	 <table border="1"> <thead> <tr> <th>PRICE</th> </tr> </thead> <tbody> <tr> <td>1-24 \$91.69</td> </tr> <tr> <td>25-49 \$87.11</td> </tr> <tr> <td>50-99 \$82.52</td> </tr> <tr> <td>100+ \$78.85</td> </tr> </tbody> </table> <p>Low PIM</p> <p>SMA Female to 7/16 DIN Female</p> <p>Max. Freq. 8 GHz</p> <p>Model No: PE91042</p>	PRICE	1-24 \$91.69	25-49 \$87.11	50-99 \$82.52	100+ \$78.85	 <table border="1"> <thead> <tr> <th>PRICE</th> </tr> </thead> <tbody> <tr> <td>1-24 \$21.16</td> </tr> <tr> <td>25-49 \$20.10</td> </tr> <tr> <td>50-99 \$19.04</td> </tr> <tr> <td>100+ \$18.20</td> </tr> </tbody> </table> <p>SMA Female to BNC Male</p> <p>VSWR 1.3:1 to 4 GHz</p> <p>Model No: PE9073</p>	PRICE	1-24 \$21.16	25-49 \$20.10	50-99 \$19.04	100+ \$18.20
	PRICE																													
1-4 \$585.14																														
5-9 \$555.88																														
10-24 \$526.63																														
25+ \$503.22																														
PRICE																														
1-24 \$90.94																														
25-49 \$86.39																														
50-99 \$81.85																														
100+ \$78.21																														
PRICE																														
1-9 \$114.30																														
10-24 \$108.59																														
25-49 \$102.87																														
50+ \$98.30																														
PRICE																														
1-24 \$91.69																														
25-49 \$87.11																														
50-99 \$82.52																														
100+ \$78.85																														
PRICE																														
1-24 \$21.16																														
25-49 \$20.10																														
50-99 \$19.04																														
100+ \$18.20																														
7	 <table border="1"> <thead> <tr> <th>PRICE</th> </tr> </thead> <tbody> <tr> <td>1-24 \$80.63</td> </tr> <tr> <td>25-49 \$76.60</td> </tr> <tr> <td>50-99 \$72.57</td> </tr> <tr> <td>100+ \$69.34</td> </tr> </tbody> </table> <p>SMA Female to BNC Male</p> <p>VSWR 1.25:1 to 8 GHz</p> <p>Model No: PE9494</p>	PRICE	1-24 \$80.63	25-49 \$76.60	50-99 \$72.57	100+ \$69.34	 <table border="1"> <thead> <tr> <th>PRICE</th> </tr> </thead> <tbody> <tr> <td>1-24 \$45.58</td> </tr> <tr> <td>25-49 \$43.30</td> </tr> <tr> <td>50-99 \$41.02</td> </tr> <tr> <td>100+ \$39.20</td> </tr> </tbody> </table> <p>SMA Female to BNC Female</p> <p>VSWR 1.3:1 to 4 GHz</p> <p>Model No: PE9075</p>	PRICE	1-24 \$45.58	25-49 \$43.30	50-99 \$41.02	100+ \$39.20	 <table border="1"> <thead> <tr> <th>PRICE</th> </tr> </thead> <tbody> <tr> <td>1-24 \$113.61</td> </tr> <tr> <td>25-49 \$107.93</td> </tr> <tr> <td>50-99 \$102.25</td> </tr> <tr> <td>100+ \$97.70</td> </tr> </tbody> </table> <p>SMA Female to BNC Female</p> <p>VSWR 1.25:1 to 8 GHz</p> <p>Model No: PE9496</p>	PRICE	1-24 \$113.61	25-49 \$107.93	50-99 \$102.25	100+ \$97.70	 <table border="1"> <thead> <tr> <th>PRICE</th> </tr> </thead> <tbody> <tr> <td>1-24 \$55.75</td> </tr> <tr> <td>25-49 \$52.96</td> </tr> <tr> <td>50-99 \$50.18</td> </tr> <tr> <td>100+ \$47.95</td> </tr> </tbody> </table> <p>SMA Female to BNC Female Bulkhead</p> <p>Max. Freq. 4 GHz</p> <p>Model No: PE9185</p>	PRICE	1-24 \$55.75	25-49 \$52.96	50-99 \$50.18	100+ \$47.95	 <table border="1"> <thead> <tr> <th>PRICE</th> </tr> </thead> <tbody> <tr> <td>1-24 \$64.59</td> </tr> <tr> <td>25-49 \$61.36</td> </tr> <tr> <td>50-99 \$58.13</td> </tr> <tr> <td>100+ \$55.55</td> </tr> </tbody> </table> <p>SMA Female to BNC Female Bulkhead</p> <p>Max. Freq. 4 GHz</p> <p>Model No: PE9407</p>	PRICE	1-24 \$64.59	25-49 \$61.36	50-99 \$58.13	100+ \$55.55
	PRICE																													
1-24 \$80.63																														
25-49 \$76.60																														
50-99 \$72.57																														
100+ \$69.34																														
PRICE																														
1-24 \$45.58																														
25-49 \$43.30																														
50-99 \$41.02																														
100+ \$39.20																														
PRICE																														
1-24 \$113.61																														
25-49 \$107.93																														
50-99 \$102.25																														
100+ \$97.70																														
PRICE																														
1-24 \$55.75																														
25-49 \$52.96																														
50-99 \$50.18																														
100+ \$47.95																														
PRICE																														
1-24 \$64.59																														
25-49 \$61.36																														
50-99 \$58.13																														
100+ \$55.55																														

ADAPTERS

See Adapter Locator on Pages 8-13

See Page 369 for Mounting Holes

Adapters

See Our Website For Current Pricing & Real-Time Stock Availability!

	A	B	C	D	E																																																		
1	 <table border="1"> <thead> <tr> <th colspan="2">PRICE</th> </tr> </thead> <tbody> <tr> <td>1-24</td> <td>\$26.54</td> </tr> <tr> <td>25-49</td> <td>\$25.21</td> </tr> <tr> <td>50-99</td> <td>\$23.89</td> </tr> <tr> <td>100+</td> <td>\$22.82</td> </tr> </tbody> </table> <p>SMA Female to 75 Ohm F Male VSWR 1.5:1 to 500 MHz</p> <p>Model No: PE91045</p>	PRICE		1-24	\$26.54	25-49	\$25.21	50-99	\$23.89	100+	\$22.82	 <table border="1"> <thead> <tr> <th colspan="2">PRICE</th> </tr> </thead> <tbody> <tr> <td>1-24</td> <td>\$55.82</td> </tr> <tr> <td>25-49</td> <td>\$53.03</td> </tr> <tr> <td>50-99</td> <td>\$50.24</td> </tr> <tr> <td>100+</td> <td>\$48.01</td> </tr> </tbody> </table> <p>SMA Female to 75 Ohm F Female</p> <p>Model No: PE91002</p>	PRICE		1-24	\$55.82	25-49	\$53.03	50-99	\$50.24	100+	\$48.01	 <table border="1"> <thead> <tr> <th colspan="2">PRICE</th> </tr> </thead> <tbody> <tr> <td>1-24</td> <td>\$21.23</td> </tr> <tr> <td>25-49</td> <td>\$20.17</td> </tr> <tr> <td>50-99</td> <td>\$19.11</td> </tr> <tr> <td>100+</td> <td>\$18.26</td> </tr> </tbody> </table> <p>SMA Female to FME Plug</p> <p>Model No: PE9703</p>	PRICE		1-24	\$21.23	25-49	\$20.17	50-99	\$19.11	100+	\$18.26	 <table border="1"> <thead> <tr> <th colspan="2">PRICE</th> </tr> </thead> <tbody> <tr> <td>1-24</td> <td>\$27.44</td> </tr> <tr> <td>25-49</td> <td>\$26.07</td> </tr> <tr> <td>50-99</td> <td>\$24.70</td> </tr> <tr> <td>100+</td> <td>\$23.60</td> </tr> </tbody> </table> <p>SMA Female to FME Jack VSWR 1.3:1 to 900 MHz</p> <p>Model No: PE9708</p>	PRICE		1-24	\$27.44	25-49	\$26.07	50-99	\$24.70	100+	\$23.60	 <table border="1"> <thead> <tr> <th colspan="2">PRICE</th> </tr> </thead> <tbody> <tr> <td>1-9</td> <td>\$182.70</td> </tr> <tr> <td>10-24</td> <td>\$173.57</td> </tr> <tr> <td>25-49</td> <td>\$164.43</td> </tr> <tr> <td>50+</td> <td>\$157.12</td> </tr> </tbody> </table> <p>SMA Female to GR874 Sexless</p> <p>Model No: PE9260</p>	PRICE		1-9	\$182.70	10-24	\$173.57	25-49	\$164.43	50+	\$157.12
	PRICE																																																						
1-24	\$26.54																																																						
25-49	\$25.21																																																						
50-99	\$23.89																																																						
100+	\$22.82																																																						
PRICE																																																							
1-24	\$55.82																																																						
25-49	\$53.03																																																						
50-99	\$50.24																																																						
100+	\$48.01																																																						
PRICE																																																							
1-24	\$21.23																																																						
25-49	\$20.17																																																						
50-99	\$19.11																																																						
100+	\$18.26																																																						
PRICE																																																							
1-24	\$27.44																																																						
25-49	\$26.07																																																						
50-99	\$24.70																																																						
100+	\$23.60																																																						
PRICE																																																							
1-9	\$182.70																																																						
10-24	\$173.57																																																						
25-49	\$164.43																																																						
50+	\$157.12																																																						
2	 <table border="1"> <thead> <tr> <th colspan="2">PRICE</th> </tr> </thead> <tbody> <tr> <td>1-24</td> <td>\$83.56</td> </tr> <tr> <td>25-49</td> <td>\$79.38</td> </tr> <tr> <td>50-99</td> <td>\$75.20</td> </tr> <tr> <td>100+</td> <td>\$71.86</td> </tr> </tbody> </table> <p>SMA Female to HN Male Max. Freq. 4 GHz</p> <p>Model No: PE9253</p>	PRICE		1-24	\$83.56	25-49	\$79.38	50-99	\$75.20	100+	\$71.86	 <table border="1"> <thead> <tr> <th colspan="2">PRICE</th> </tr> </thead> <tbody> <tr> <td>1-24</td> <td>\$68.50</td> </tr> <tr> <td>25-49</td> <td>\$65.08</td> </tr> <tr> <td>50-99</td> <td>\$61.65</td> </tr> <tr> <td>100+</td> <td>\$58.91</td> </tr> </tbody> </table> <p>SMA Female to HN Female</p> <p>Model No: PE9255</p>	PRICE		1-24	\$68.50	25-49	\$65.08	50-99	\$61.65	100+	\$58.91	 <table border="1"> <thead> <tr> <th colspan="2">PRICE</th> </tr> </thead> <tbody> <tr> <td>1-24</td> <td>\$82.36</td> </tr> <tr> <td>25-49</td> <td>\$78.24</td> </tr> <tr> <td>50-99</td> <td>\$74.12</td> </tr> <tr> <td>100+</td> <td>\$70.83</td> </tr> </tbody> </table> <p>SMA Female to MCX Plug</p> <p>Model No: PE9471</p>	PRICE		1-24	\$82.36	25-49	\$78.24	50-99	\$74.12	100+	\$70.83	 <table border="1"> <thead> <tr> <th colspan="2">PRICE</th> </tr> </thead> <tbody> <tr> <td>1-24</td> <td>\$80.98</td> </tr> <tr> <td>25-49</td> <td>\$76.93</td> </tr> <tr> <td>50-99</td> <td>\$72.88</td> </tr> <tr> <td>100+</td> <td>\$69.64</td> </tr> </tbody> </table> <p>SMA Female to MCX Jack</p> <p>Model No: PE9470</p>	PRICE		1-24	\$80.98	25-49	\$76.93	50-99	\$72.88	100+	\$69.64	 <table border="1"> <thead> <tr> <th colspan="2">PRICE</th> </tr> </thead> <tbody> <tr> <td>1-24</td> <td>\$90.69</td> </tr> <tr> <td>25-49</td> <td>\$86.16</td> </tr> <tr> <td>50-99</td> <td>\$81.62</td> </tr> <tr> <td>100+</td> <td>\$77.99</td> </tr> </tbody> </table> <p>SMA Female to Full Detent Mini SMP Male VSWR 1.2:1 to 18 GHz</p> <p>Model No: PE91299</p>	PRICE		1-24	\$90.69	25-49	\$86.16	50-99	\$81.62	100+	\$77.99
	PRICE																																																						
1-24	\$83.56																																																						
25-49	\$79.38																																																						
50-99	\$75.20																																																						
100+	\$71.86																																																						
PRICE																																																							
1-24	\$68.50																																																						
25-49	\$65.08																																																						
50-99	\$61.65																																																						
100+	\$58.91																																																						
PRICE																																																							
1-24	\$82.36																																																						
25-49	\$78.24																																																						
50-99	\$74.12																																																						
100+	\$70.83																																																						
PRICE																																																							
1-24	\$80.98																																																						
25-49	\$76.93																																																						
50-99	\$72.88																																																						
100+	\$69.64																																																						
PRICE																																																							
1-24	\$90.69																																																						
25-49	\$86.16																																																						
50-99	\$81.62																																																						
100+	\$77.99																																																						
3	 <table border="1"> <thead> <tr> <th colspan="2">PRICE</th> </tr> </thead> <tbody> <tr> <td>1-9</td> <td>\$175.00</td> </tr> <tr> <td>10-24</td> <td>\$166.25</td> </tr> <tr> <td>25-49</td> <td>\$157.50</td> </tr> <tr> <td>50+</td> <td>\$150.50</td> </tr> </tbody> </table> <p>SMA Female to Full Detent Mini SMP Male VSWR 1.2:1 to 26.5 GHz</p> <p>Model No: PE91129</p>	PRICE		1-9	\$175.00	10-24	\$166.25	25-49	\$157.50	50+	\$150.50	 <table border="1"> <thead> <tr> <th colspan="2">PRICE</th> </tr> </thead> <tbody> <tr> <td>1-24</td> <td>\$100.77</td> </tr> <tr> <td>25-49</td> <td>\$95.73</td> </tr> <tr> <td>50-99</td> <td>\$90.69</td> </tr> <tr> <td>100+</td> <td>\$86.66</td> </tr> </tbody> </table> <p>SMA Female to Smooth Bore Mini SMP Male VSWR 1.2:1 to 18 GHz</p> <p>Model No: PE91300</p>	PRICE		1-24	\$100.77	25-49	\$95.73	50-99	\$90.69	100+	\$86.66	 <table border="1"> <thead> <tr> <th colspan="2">PRICE</th> </tr> </thead> <tbody> <tr> <td>1-24</td> <td>\$89.85</td> </tr> <tr> <td>25-49</td> <td>\$85.36</td> </tr> <tr> <td>50-99</td> <td>\$80.87</td> </tr> <tr> <td>100+</td> <td>\$77.27</td> </tr> </tbody> </table> <p>SMA Female to Mini SMP Female VSWR 1.2:1 to 18 GHz</p> <p>Model No: PE91301</p>	PRICE		1-24	\$89.85	25-49	\$85.36	50-99	\$80.87	100+	\$77.27	 <table border="1"> <thead> <tr> <th colspan="2">PRICE</th> </tr> </thead> <tbody> <tr> <td>1-9</td> <td>\$157.83</td> </tr> <tr> <td>10-24</td> <td>\$149.94</td> </tr> <tr> <td>25-49</td> <td>\$142.05</td> </tr> <tr> <td>50+</td> <td>\$135.73</td> </tr> </tbody> </table> <p>PRECISION SMA Female to Mini SMP Female VSWR 1.2:1 to 26.5 GHz</p> <p>Model No: PE91051</p>	PRICE		1-9	\$157.83	10-24	\$149.94	25-49	\$142.05	50+	\$135.73	 <table border="1"> <thead> <tr> <th colspan="2">PRICE</th> </tr> </thead> <tbody> <tr> <td>1-24</td> <td>\$92.95</td> </tr> <tr> <td>25-49</td> <td>\$88.30</td> </tr> <tr> <td>50-99</td> <td>\$83.66</td> </tr> <tr> <td>100+</td> <td>\$79.94</td> </tr> </tbody> </table> <p>SMA Female to MMCX Plug</p> <p>Model No: PE9475</p>	PRICE		1-24	\$92.95	25-49	\$88.30	50-99	\$83.66	100+	\$79.94
	PRICE																																																						
1-9	\$175.00																																																						
10-24	\$166.25																																																						
25-49	\$157.50																																																						
50+	\$150.50																																																						
PRICE																																																							
1-24	\$100.77																																																						
25-49	\$95.73																																																						
50-99	\$90.69																																																						
100+	\$86.66																																																						
PRICE																																																							
1-24	\$89.85																																																						
25-49	\$85.36																																																						
50-99	\$80.87																																																						
100+	\$77.27																																																						
PRICE																																																							
1-9	\$157.83																																																						
10-24	\$149.94																																																						
25-49	\$142.05																																																						
50+	\$135.73																																																						
PRICE																																																							
1-24	\$92.95																																																						
25-49	\$88.30																																																						
50-99	\$83.66																																																						
100+	\$79.94																																																						
4	 <table border="1"> <thead> <tr> <th colspan="2">PRICE</th> </tr> </thead> <tbody> <tr> <td>1-24</td> <td>\$84.80</td> </tr> <tr> <td>25-49</td> <td>\$80.56</td> </tr> <tr> <td>50-99</td> <td>\$76.32</td> </tr> <tr> <td>100+</td> <td>\$72.93</td> </tr> </tbody> </table> <p>SMA Female to MMCX Jack</p> <p>Model No: PE9477</p>	PRICE		1-24	\$84.80	25-49	\$80.56	50-99	\$76.32	100+	\$72.93	 <table border="1"> <thead> <tr> <th colspan="2">PRICE</th> </tr> </thead> <tbody> <tr> <td>1-9</td> <td>\$195.38</td> </tr> <tr> <td>10-24</td> <td>\$185.61</td> </tr> <tr> <td>25-49</td> <td>\$175.84</td> </tr> <tr> <td>50+</td> <td>\$168.03</td> </tr> </tbody> </table> <p>NEW SMA Female to Snap-On MMBX Plug VSWR 1.08:1 to 12.4 GHz</p> <p>Model No: PE91361</p>	PRICE		1-9	\$195.38	10-24	\$185.61	25-49	\$175.84	50+	\$168.03	 <table border="1"> <thead> <tr> <th colspan="2">PRICE</th> </tr> </thead> <tbody> <tr> <td>1-9</td> <td>\$177.22</td> </tr> <tr> <td>10-24</td> <td>\$168.36</td> </tr> <tr> <td>25-49</td> <td>\$159.50</td> </tr> <tr> <td>50+</td> <td>\$152.41</td> </tr> </tbody> </table> <p>NEW SMA Female to Snap-On MMBX Jack VSWR 1.08:1 to 12.4 GHz</p> <p>Model No: PE91363</p>	PRICE		1-9	\$177.22	10-24	\$168.36	25-49	\$159.50	50+	\$152.41	 <table border="1"> <thead> <tr> <th colspan="2">PRICE</th> </tr> </thead> <tbody> <tr> <td>1-24</td> <td>\$16.99</td> </tr> <tr> <td>25-49</td> <td>\$16.14</td> </tr> <tr> <td>50-99</td> <td>\$15.29</td> </tr> <tr> <td>100+</td> <td>\$14.61</td> </tr> </tbody> </table> <p>SMA Female to N Male VSWR 1.3:1 to 11 GHz</p> <p>Model No: PE9081</p>	PRICE		1-24	\$16.99	25-49	\$16.14	50-99	\$15.29	100+	\$14.61	 <table border="1"> <thead> <tr> <th colspan="2">PRICE</th> </tr> </thead> <tbody> <tr> <td>1-9</td> <td>\$205.73</td> </tr> <tr> <td>10-24</td> <td>\$195.44</td> </tr> <tr> <td>25-49</td> <td>\$185.16</td> </tr> <tr> <td>50+</td> <td>\$176.93</td> </tr> </tbody> </table> <p>SMA Female to QD N Male</p> <p>Model No: PE9684</p>	PRICE		1-9	\$205.73	10-24	\$195.44	25-49	\$185.16	50+	\$176.93
	PRICE																																																						
1-24	\$84.80																																																						
25-49	\$80.56																																																						
50-99	\$76.32																																																						
100+	\$72.93																																																						
PRICE																																																							
1-9	\$195.38																																																						
10-24	\$185.61																																																						
25-49	\$175.84																																																						
50+	\$168.03																																																						
PRICE																																																							
1-9	\$177.22																																																						
10-24	\$168.36																																																						
25-49	\$159.50																																																						
50+	\$152.41																																																						
PRICE																																																							
1-24	\$16.99																																																						
25-49	\$16.14																																																						
50-99	\$15.29																																																						
100+	\$14.61																																																						
PRICE																																																							
1-9	\$205.73																																																						
10-24	\$195.44																																																						
25-49	\$185.16																																																						
50+	\$176.93																																																						
5	 <table border="1"> <thead> <tr> <th colspan="2">PRICE</th> </tr> </thead> <tbody> <tr> <td>1-24</td> <td>\$70.59</td> </tr> <tr> <td>25-49</td> <td>\$67.06</td> </tr> <tr> <td>50-99</td> <td>\$63.53</td> </tr> <tr> <td>100+</td> <td>\$60.71</td> </tr> </tbody> </table> <p>SMA Female to N Male Bulkhead Max. Freq. 11 GHz</p> <p>Model No: PE9551</p>	PRICE		1-24	\$70.59	25-49	\$67.06	50-99	\$63.53	100+	\$60.71	 <table border="1"> <thead> <tr> <th colspan="2">PRICE</th> </tr> </thead> <tbody> <tr> <td>1-24</td> <td>\$92.25</td> </tr> <tr> <td>25-49</td> <td>\$87.64</td> </tr> <tr> <td>50-99</td> <td>\$83.03</td> </tr> <tr> <td>100+</td> <td>\$79.34</td> </tr> </tbody> </table> <p>SMA Female to N Male 4 Hole Flange-Mounting Hole A05 VSWR 1.2:1 to 12.4 GHz</p> <p>Model No: PE9275</p>	PRICE		1-24	\$92.25	25-49	\$87.64	50-99	\$83.03	100+	\$79.34	 <table border="1"> <thead> <tr> <th colspan="2">PRICE</th> </tr> </thead> <tbody> <tr> <td>1-9</td> <td>\$177.24</td> </tr> <tr> <td>10-24</td> <td>\$168.38</td> </tr> <tr> <td>25-49</td> <td>\$159.52</td> </tr> <tr> <td>50+</td> <td>\$152.43</td> </tr> </tbody> </table> <p>PRECISION SMA Female to N Male 4 Hole Flange-Mounting Hole A05 VSWR 1.15:1 to 18 GHz</p> <p>Model No: PE9498</p>	PRICE		1-9	\$177.24	10-24	\$168.38	25-49	\$159.52	50+	\$152.43	 <table border="1"> <thead> <tr> <th colspan="2">PRICE</th> </tr> </thead> <tbody> <tr> <td>1-24</td> <td>\$21.11</td> </tr> <tr> <td>25-49</td> <td>\$20.05</td> </tr> <tr> <td>50-99</td> <td>\$19.00</td> </tr> <tr> <td>100+</td> <td>\$18.15</td> </tr> </tbody> </table> <p>SMA Female to N Female VSWR 1.3:1 to 11 GHz</p> <p>Model No: PE9083</p>	PRICE		1-24	\$21.11	25-49	\$20.05	50-99	\$19.00	100+	\$18.15	 <table border="1"> <thead> <tr> <th colspan="2">PRICE</th> </tr> </thead> <tbody> <tr> <td>1-24</td> <td>\$100.81</td> </tr> <tr> <td>25-49</td> <td>\$95.77</td> </tr> <tr> <td>50-99</td> <td>\$90.73</td> </tr> <tr> <td>100+</td> <td>\$86.70</td> </tr> </tbody> </table> <p>PRECISION SMA Female to N Female VSWR 1.15:1 to 18 GHz</p> <p>Model No: PE9432</p>	PRICE		1-24	\$100.81	25-49	\$95.77	50-99	\$90.73	100+	\$86.70
	PRICE																																																						
1-24	\$70.59																																																						
25-49	\$67.06																																																						
50-99	\$63.53																																																						
100+	\$60.71																																																						
PRICE																																																							
1-24	\$92.25																																																						
25-49	\$87.64																																																						
50-99	\$83.03																																																						
100+	\$79.34																																																						
PRICE																																																							
1-9	\$177.24																																																						
10-24	\$168.38																																																						
25-49	\$159.52																																																						
50+	\$152.43																																																						
PRICE																																																							
1-24	\$21.11																																																						
25-49	\$20.05																																																						
50-99	\$19.00																																																						
100+	\$18.15																																																						
PRICE																																																							
1-24	\$100.81																																																						
25-49	\$95.77																																																						
50-99	\$90.73																																																						
100+	\$86.70																																																						
6	 <table border="1"> <thead> <tr> <th colspan="2">PRICE</th> </tr> </thead> <tbody> <tr> <td>1-24</td> <td>\$51.00</td> </tr> <tr> <td>25-49</td> <td>\$48.45</td> </tr> <tr> <td>50-99</td> <td>\$45.90</td> </tr> <tr> <td>100+</td> <td>\$43.86</td> </tr> </tbody> </table> <p>SMA Female to N Female Bulkhead VSWR 1.3:1 to 11 GHz</p> <p>Model No: PE9252</p>	PRICE		1-24	\$51.00	25-49	\$48.45	50-99	\$45.90	100+	\$43.86	 <table border="1"> <thead> <tr> <th colspan="2">PRICE</th> </tr> </thead> <tbody> <tr> <td>1-9</td> <td>\$157.52</td> </tr> <tr> <td>10-24</td> <td>\$149.64</td> </tr> <tr> <td>25-49</td> <td>\$141.77</td> </tr> <tr> <td>50+</td> <td>\$135.47</td> </tr> </tbody> </table> <p>PRECISION SMA Female to N Female Bulkhead VSWR 1.15:1 to 18 GHz</p> <p>Model No: PE9486</p>	PRICE		1-9	\$157.52	10-24	\$149.64	25-49	\$141.77	50+	\$135.47	 <table border="1"> <thead> <tr> <th colspan="2">PRICE</th> </tr> </thead> <tbody> <tr> <td>1-24</td> <td>\$64.37</td> </tr> <tr> <td>25-49</td> <td>\$61.15</td> </tr> <tr> <td>50-99</td> <td>\$57.93</td> </tr> <tr> <td>100+</td> <td>\$55.36</td> </tr> </tbody> </table> <p>SMA Female to N Female 4 Hole Flange-Mounting Hole A05 VSWR 1.3:1 to 11 GHz</p> <p>Model No: PE9104</p>	PRICE		1-24	\$64.37	25-49	\$61.15	50-99	\$57.93	100+	\$55.36	 <table border="1"> <thead> <tr> <th colspan="2">PRICE</th> </tr> </thead> <tbody> <tr> <td>1-9</td> <td>\$157.52</td> </tr> <tr> <td>10-24</td> <td>\$149.64</td> </tr> <tr> <td>25-49</td> <td>\$141.77</td> </tr> <tr> <td>50+</td> <td>\$135.47</td> </tr> </tbody> </table> <p>PRECISION SMA Female to N Female 4 Hole Flange-Mounting Hole A05 VSWR 1.15:1 to 18 GHz</p> <p>Model No: PE9434</p>	PRICE		1-9	\$157.52	10-24	\$149.64	25-49	\$141.77	50+	\$135.47	 <table border="1"> <thead> <tr> <th colspan="2">PRICE</th> </tr> </thead> <tbody> <tr> <td>1-24</td> <td>\$75.09</td> </tr> <tr> <td>25-49</td> <td>\$71.34</td> </tr> <tr> <td>50-99</td> <td>\$67.58</td> </tr> <tr> <td>100+</td> <td>\$64.58</td> </tr> </tbody> </table> <p>SMA Female to N Female Bulkhead VSWR 1.25:1 to 6 GHz</p> <p>Model No: PE9408</p>	PRICE		1-24	\$75.09	25-49	\$71.34	50-99	\$67.58	100+	\$64.58
	PRICE																																																						
1-24	\$51.00																																																						
25-49	\$48.45																																																						
50-99	\$45.90																																																						
100+	\$43.86																																																						
PRICE																																																							
1-9	\$157.52																																																						
10-24	\$149.64																																																						
25-49	\$141.77																																																						
50+	\$135.47																																																						
PRICE																																																							
1-24	\$64.37																																																						
25-49	\$61.15																																																						
50-99	\$57.93																																																						
100+	\$55.36																																																						
PRICE																																																							
1-9	\$157.52																																																						
10-24	\$149.64																																																						
25-49	\$141.77																																																						
50+	\$135.47																																																						
PRICE																																																							
1-24	\$75.09																																																						
25-49	\$71.34																																																						
50-99	\$67.58																																																						
100+	\$64.58																																																						
7	 <table border="1"> <thead> <tr> <th colspan="2">PRICE</th> </tr> </thead> <tbody> <tr> <td>1-9</td> <td>\$161.70</td> </tr> <tr> <td>10-24</td> <td>\$153.62</td> </tr> <tr> <td>25-49</td> <td>\$145.53</td> </tr> <tr> <td>50+</td> <td>\$139.06</td> </tr> </tbody> </table> <p>PRECISION SMA Female to N Female Bulkhead-Mounting Hole G01 VSWR 1.15:1 to 18 GHz</p> <p>Model No: PE9435</p>	PRICE		1-9	\$161.70	10-24	\$153.62	25-49	\$145.53	50+	\$139.06	 <table border="1"> <thead> <tr> <th colspan="2">PRICE</th> </tr> </thead> <tbody> <tr> <td>1-24</td> <td>\$63.88</td> </tr> <tr> <td>25-49</td> <td>\$60.69</td> </tr> <tr> <td>50-99</td> <td>\$57.49</td> </tr> <tr> <td>100+</td> <td>\$54.94</td> </tr> </tbody> </table> <p>SMA Female to QMA Male Max. Freq. 18 GHz</p> <p>Model No: PE9786</p>	PRICE		1-24	\$63.88	25-49	\$60.69	50-99	\$57.49	100+	\$54.94	 <table border="1"> <thead> <tr> <th colspan="2">PRICE</th> </tr> </thead> <tbody> <tr> <td>1-24</td> <td>\$27.92</td> </tr> <tr> <td>25-49</td> <td>\$26.52</td> </tr> <tr> <td>50-99</td> <td>\$25.13</td> </tr> <tr> <td>100+</td> <td>\$24.01</td> </tr> </tbody> </table> <p>SMA Female to SMB Plug VSWR 1.3:1 to 4 GHz</p> <p>Model No: PE9142</p>	PRICE		1-24	\$27.92	25-49	\$26.52	50-99	\$25.13	100+	\$24.01	 <table border="1"> <thead> <tr> <th colspan="2">PRICE</th> </tr> </thead> <tbody> <tr> <td>1-24</td> <td>\$57.95</td> </tr> <tr> <td>25-49</td> <td>\$55.05</td> </tr> <tr> <td>50-99</td> <td>\$52.16</td> </tr> <tr> <td>100+</td> <td>\$49.84</td> </tr> </tbody> </table> <p>SMA Female to SMB Jack VSWR 1.46:1 to 4 GHz</p> <p>Model No: PE9143</p>	PRICE		1-24	\$57.95	25-49	\$55.05	50-99	\$52.16	100+	\$49.84	 <table border="1"> <thead> <tr> <th colspan="2">PRICE</th> </tr> </thead> <tbody> <tr> <td>1-24</td> <td>\$56.13</td> </tr> <tr> <td>25-49</td> <td>\$53.32</td> </tr> <tr> <td>50-99</td> <td>\$50.52</td> </tr> <tr> <td>100+</td> <td>\$48.27</td> </tr> </tbody> </table> <p>SMA Female to SMC Plug VSWR 1.2:1 to 10 GHz</p> <p>Model No: PE9146</p>	PRICE		1-24	\$56.13	25-49	\$53.32	50-99	\$50.52	100+	\$48.27
	PRICE																																																						
1-9	\$161.70																																																						
10-24	\$153.62																																																						
25-49	\$145.53																																																						
50+	\$139.06																																																						
PRICE																																																							
1-24	\$63.88																																																						
25-49	\$60.69																																																						
50-99	\$57.49																																																						
100+	\$54.94																																																						
PRICE																																																							
1-24	\$27.92																																																						
25-49	\$26.52																																																						
50-99	\$25.13																																																						
100+	\$24.01																																																						
PRICE																																																							
1-24	\$57.95																																																						
25-49	\$55.05																																																						
50-99	\$52.16																																																						
100+	\$49.84																																																						
PRICE																																																							
1-24	\$56.13																																																						
25-49	\$53.32																																																						
50-99	\$50.52																																																						
100+	\$48.27																																																						

ADAPTERS

See Adapter Locator on Pages 8-13

See Page 369 for Mounting Holes

Adapters

See Our Website For Current Pricing & Real-Time Stock Availability!

	A	B	C	D	E																																																		
1	 <table border="1"> <thead> <tr> <th colspan="2">PRICE</th> </tr> </thead> <tbody> <tr> <td>1-24</td> <td>\$60.54</td> </tr> <tr> <td>25-49</td> <td>\$57.51</td> </tr> <tr> <td>50-99</td> <td>\$54.49</td> </tr> <tr> <td>100+</td> <td>\$52.06</td> </tr> </tbody> </table> <p>SMA Female to SMC Jack Max. Freq. 10 GHz Model No: PE9147</p>	PRICE		1-24	\$60.54	25-49	\$57.51	50-99	\$54.49	100+	\$52.06	 <table border="1"> <thead> <tr> <th colspan="2">PRICE</th> </tr> </thead> <tbody> <tr> <td>1-24</td> <td>\$71.57</td> </tr> <tr> <td>25-49</td> <td>\$67.99</td> </tr> <tr> <td>50-99</td> <td>\$64.41</td> </tr> <tr> <td>100+</td> <td>\$61.55</td> </tr> </tbody> </table> <p>SMA Female to Full Detent SMP Male VSWR 1.2:1 to 18 GHz Model No: PE91305</p>	PRICE		1-24	\$71.57	25-49	\$67.99	50-99	\$64.41	100+	\$61.55	 <table border="1"> <thead> <tr> <th colspan="2">PRICE</th> </tr> </thead> <tbody> <tr> <td>1-9</td> <td>\$121.91</td> </tr> <tr> <td>10-24</td> <td>\$115.81</td> </tr> <tr> <td>25-49</td> <td>\$109.72</td> </tr> <tr> <td>50+</td> <td>\$104.84</td> </tr> </tbody> </table> <p>PRECISION SMA Female to Full Detent SMP Male VSWR 1.2:1 to 26.5 GHz Model No: PE91056</p>	PRICE		1-9	\$121.91	10-24	\$115.81	25-49	\$109.72	50+	\$104.84	 <table border="1"> <thead> <tr> <th colspan="2">PRICE</th> </tr> </thead> <tbody> <tr> <td>1-9</td> <td>\$130.19</td> </tr> <tr> <td>10-24</td> <td>\$123.68</td> </tr> <tr> <td>25-49</td> <td>\$117.17</td> </tr> <tr> <td>50+</td> <td>\$111.96</td> </tr> </tbody> </table> <p>SMA Female to Full Detent SMP Male Bulkhead-Mounting Hole F05 VSWR 1.3:1 to 26.5 GHz Model No: PE91054</p>	PRICE		1-9	\$130.19	10-24	\$123.68	25-49	\$117.17	50+	\$111.96	 <table border="1"> <thead> <tr> <th colspan="2">PRICE</th> </tr> </thead> <tbody> <tr> <td>1-9</td> <td>\$123.04</td> </tr> <tr> <td>10-24</td> <td>\$116.89</td> </tr> <tr> <td>25-49</td> <td>\$110.74</td> </tr> <tr> <td>50+</td> <td>\$105.81</td> </tr> </tbody> </table> <p>PRECISION SMA Female to Full Detent SMP Male 2 Hole Flange-Mounting Hole C01 VSWR 1.2:1 to 26.5 GHz Model No: PE91058</p>	PRICE		1-9	\$123.04	10-24	\$116.89	25-49	\$110.74	50+	\$105.81
	PRICE																																																						
1-24	\$60.54																																																						
25-49	\$57.51																																																						
50-99	\$54.49																																																						
100+	\$52.06																																																						
PRICE																																																							
1-24	\$71.57																																																						
25-49	\$67.99																																																						
50-99	\$64.41																																																						
100+	\$61.55																																																						
PRICE																																																							
1-9	\$121.91																																																						
10-24	\$115.81																																																						
25-49	\$109.72																																																						
50+	\$104.84																																																						
PRICE																																																							
1-9	\$130.19																																																						
10-24	\$123.68																																																						
25-49	\$117.17																																																						
50+	\$111.96																																																						
PRICE																																																							
1-9	\$123.04																																																						
10-24	\$116.89																																																						
25-49	\$110.74																																																						
50+	\$105.81																																																						
2	 <table border="1"> <thead> <tr> <th colspan="2">PRICE</th> </tr> </thead> <tbody> <tr> <td>1-24</td> <td>\$71.57</td> </tr> <tr> <td>25-49</td> <td>\$67.99</td> </tr> <tr> <td>50-99</td> <td>\$64.41</td> </tr> <tr> <td>100+</td> <td>\$61.55</td> </tr> </tbody> </table> <p>SMA Female to Limited Detent SMP Male VSWR 1.2:1 to 18 GHz Model No: PE91306</p>	PRICE		1-24	\$71.57	25-49	\$67.99	50-99	\$64.41	100+	\$61.55	 <table border="1"> <thead> <tr> <th colspan="2">PRICE</th> </tr> </thead> <tbody> <tr> <td>1-9</td> <td>\$124.77</td> </tr> <tr> <td>10-24</td> <td>\$118.53</td> </tr> <tr> <td>25-49</td> <td>\$112.29</td> </tr> <tr> <td>50+</td> <td>\$107.30</td> </tr> </tbody> </table> <p>PRECISION SMA Female to Limited Detent SMP Male VSWR 1.2:1 to 26.5 GHz Model No: PE91050</p>	PRICE		1-9	\$124.77	10-24	\$118.53	25-49	\$112.29	50+	\$107.30	 <table border="1"> <thead> <tr> <th colspan="2">PRICE</th> </tr> </thead> <tbody> <tr> <td>1-9</td> <td>\$179.50</td> </tr> <tr> <td>10-24</td> <td>\$170.53</td> </tr> <tr> <td>25-49</td> <td>\$161.55</td> </tr> <tr> <td>50+</td> <td>\$154.37</td> </tr> </tbody> </table> <p>PRECISION SMA Female to Limited Detent SMP Male VSWR 1.2:1 to 18 GHz Model No: PE9512</p>	PRICE		1-9	\$179.50	10-24	\$170.53	25-49	\$161.55	50+	\$154.37	 <table border="1"> <thead> <tr> <th colspan="2">PRICE</th> </tr> </thead> <tbody> <tr> <td>1-9</td> <td>\$408.56</td> </tr> <tr> <td>10-24</td> <td>\$388.13</td> </tr> <tr> <td>25-49</td> <td>\$367.70</td> </tr> <tr> <td>50+</td> <td>\$351.36</td> </tr> </tbody> </table> <p>SMA Female to Limited Detent SMP Male Max. Freq. 26.5 GHz Model No: PE9778</p>	PRICE		1-9	\$408.56	10-24	\$388.13	25-49	\$367.70	50+	\$351.36	 <table border="1"> <thead> <tr> <th colspan="2">PRICE</th> </tr> </thead> <tbody> <tr> <td>1-9</td> <td>\$135.00</td> </tr> <tr> <td>10-24</td> <td>\$128.25</td> </tr> <tr> <td>25-49</td> <td>\$121.50</td> </tr> <tr> <td>50+</td> <td>\$116.10</td> </tr> </tbody> </table> <p>PRECISION SMA Female to Limited Detent SMP Male 2 Hole Flange-Mounting Hole C05 VSWR 1.2:1 to 26.5 GHz Model No: PE91066</p>	PRICE		1-9	\$135.00	10-24	\$128.25	25-49	\$121.50	50+	\$116.10
	PRICE																																																						
1-24	\$71.57																																																						
25-49	\$67.99																																																						
50-99	\$64.41																																																						
100+	\$61.55																																																						
PRICE																																																							
1-9	\$124.77																																																						
10-24	\$118.53																																																						
25-49	\$112.29																																																						
50+	\$107.30																																																						
PRICE																																																							
1-9	\$179.50																																																						
10-24	\$170.53																																																						
25-49	\$161.55																																																						
50+	\$154.37																																																						
PRICE																																																							
1-9	\$408.56																																																						
10-24	\$388.13																																																						
25-49	\$367.70																																																						
50+	\$351.36																																																						
PRICE																																																							
1-9	\$135.00																																																						
10-24	\$128.25																																																						
25-49	\$121.50																																																						
50+	\$116.10																																																						
3	 <table border="1"> <thead> <tr> <th colspan="2">PRICE</th> </tr> </thead> <tbody> <tr> <td>1-24</td> <td>\$71.57</td> </tr> <tr> <td>25-49</td> <td>\$67.99</td> </tr> <tr> <td>50-99</td> <td>\$64.41</td> </tr> <tr> <td>100+</td> <td>\$61.55</td> </tr> </tbody> </table> <p>SMA Female to Smooth Bore SMP Male VSWR 1.2:1 to 18 GHz Model No: PE91307</p>	PRICE		1-24	\$71.57	25-49	\$67.99	50-99	\$64.41	100+	\$61.55	 <table border="1"> <thead> <tr> <th colspan="2">PRICE</th> </tr> </thead> <tbody> <tr> <td>1-9</td> <td>\$131.83</td> </tr> <tr> <td>10-24</td> <td>\$125.24</td> </tr> <tr> <td>25-49</td> <td>\$118.65</td> </tr> <tr> <td>50+</td> <td>\$113.37</td> </tr> </tbody> </table> <p>PRECISION SMA Female to Smooth Bore SMP Male VSWR 1.2:1 to 26.5 GHz Model No: PE91049</p>	PRICE		1-9	\$131.83	10-24	\$125.24	25-49	\$118.65	50+	\$113.37	 <table border="1"> <thead> <tr> <th colspan="2">PRICE</th> </tr> </thead> <tbody> <tr> <td>1-9</td> <td>\$121.91</td> </tr> <tr> <td>10-24</td> <td>\$115.81</td> </tr> <tr> <td>25-49</td> <td>\$109.72</td> </tr> <tr> <td>50+</td> <td>\$104.84</td> </tr> </tbody> </table> <p>PRECISION SMA Female to Smooth Bore SMP Male 2 Hole Flange-Mounting Hole C05 VSWR 1.2:1 to 26.5 GHz Model No: PE91061</p>	PRICE		1-9	\$121.91	10-24	\$115.81	25-49	\$109.72	50+	\$104.84	 <table border="1"> <thead> <tr> <th colspan="2">PRICE</th> </tr> </thead> <tbody> <tr> <td>1-9</td> <td>\$124.43</td> </tr> <tr> <td>10-24</td> <td>\$118.21</td> </tr> <tr> <td>25-49</td> <td>\$111.99</td> </tr> <tr> <td>50+</td> <td>\$107.01</td> </tr> </tbody> </table> <p>PRECISION SMA Female to SMP Male 2 Hole Flange-Mounting Hole C05 VSWR 1.2:1 to 26.5 GHz Model No: PE91057</p>	PRICE		1-9	\$124.43	10-24	\$118.21	25-49	\$111.99	50+	\$107.01	 <table border="1"> <thead> <tr> <th colspan="2">PRICE</th> </tr> </thead> <tbody> <tr> <td>1-9</td> <td>\$144.65</td> </tr> <tr> <td>10-24</td> <td>\$137.42</td> </tr> <tr> <td>25-49</td> <td>\$130.19</td> </tr> <tr> <td>50+</td> <td>\$124.40</td> </tr> </tbody> </table> <p>PRECISION SMA Female to SMP Male 4 Hole Flange-Mounting Hole A01 VSWR 1.2:1 to 26.5 GHz Model No: PE91059</p>	PRICE		1-9	\$144.65	10-24	\$137.42	25-49	\$130.19	50+	\$124.40
	PRICE																																																						
1-24	\$71.57																																																						
25-49	\$67.99																																																						
50-99	\$64.41																																																						
100+	\$61.55																																																						
PRICE																																																							
1-9	\$131.83																																																						
10-24	\$125.24																																																						
25-49	\$118.65																																																						
50+	\$113.37																																																						
PRICE																																																							
1-9	\$121.91																																																						
10-24	\$115.81																																																						
25-49	\$109.72																																																						
50+	\$104.84																																																						
PRICE																																																							
1-9	\$124.43																																																						
10-24	\$118.21																																																						
25-49	\$111.99																																																						
50+	\$107.01																																																						
PRICE																																																							
1-9	\$144.65																																																						
10-24	\$137.42																																																						
25-49	\$130.19																																																						
50+	\$124.40																																																						
4	 <table border="1"> <thead> <tr> <th colspan="2">PRICE</th> </tr> </thead> <tbody> <tr> <td>1-24</td> <td>\$70.27</td> </tr> <tr> <td>25-49</td> <td>\$66.76</td> </tr> <tr> <td>50-99</td> <td>\$63.24</td> </tr> <tr> <td>100+</td> <td>\$60.43</td> </tr> </tbody> </table> <p>SMA Female to SMP Female VSWR 1.2:1 to 18 GHz Model No: PE91308</p>	PRICE		1-24	\$70.27	25-49	\$66.76	50-99	\$63.24	100+	\$60.43	 <table border="1"> <thead> <tr> <th colspan="2">PRICE</th> </tr> </thead> <tbody> <tr> <td>1-9</td> <td>\$124.05</td> </tr> <tr> <td>10-24</td> <td>\$117.85</td> </tr> <tr> <td>25-49</td> <td>\$111.65</td> </tr> <tr> <td>50+</td> <td>\$106.68</td> </tr> </tbody> </table> <p>PRECISION SMA Female to SMP Female VSWR 1.2:1 to 26.5 GHz Model No: PE91064</p>	PRICE		1-9	\$124.05	10-24	\$117.85	25-49	\$111.65	50+	\$106.68	 <table border="1"> <thead> <tr> <th colspan="2">PRICE</th> </tr> </thead> <tbody> <tr> <td>1-9</td> <td>\$220.65</td> </tr> <tr> <td>10-24</td> <td>\$209.62</td> </tr> <tr> <td>25-49</td> <td>\$198.59</td> </tr> <tr> <td>50+</td> <td>\$189.76</td> </tr> </tbody> </table> <p>PRECISION SMA Female to SMP Female VSWR 1.2:1 to 18 GHz Model No: PE9779</p>	PRICE		1-9	\$220.65	10-24	\$209.62	25-49	\$198.59	50+	\$189.76	 <table border="1"> <thead> <tr> <th colspan="2">PRICE</th> </tr> </thead> <tbody> <tr> <td>1-24</td> <td>\$52.98</td> </tr> <tr> <td>25-49</td> <td>\$50.33</td> </tr> <tr> <td>50-99</td> <td>\$47.68</td> </tr> <tr> <td>100+</td> <td>\$45.56</td> </tr> </tbody> </table> <p>SMA Female to SSMA Male VSWR 1.3:1 to 18 GHz Model No: PE9188</p>	PRICE		1-24	\$52.98	25-49	\$50.33	50-99	\$47.68	100+	\$45.56	 <table border="1"> <thead> <tr> <th colspan="2">PRICE</th> </tr> </thead> <tbody> <tr> <td>1-24</td> <td>\$71.18</td> </tr> <tr> <td>25-49</td> <td>\$67.62</td> </tr> <tr> <td>50-99</td> <td>\$64.06</td> </tr> <tr> <td>100+</td> <td>\$61.21</td> </tr> </tbody> </table> <p>SMA Female to SSMA Female VSWR 1.4:1 to 18 GHz Model No: PE9399</p>	PRICE		1-24	\$71.18	25-49	\$67.62	50-99	\$64.06	100+	\$61.21
	PRICE																																																						
1-24	\$70.27																																																						
25-49	\$66.76																																																						
50-99	\$63.24																																																						
100+	\$60.43																																																						
PRICE																																																							
1-9	\$124.05																																																						
10-24	\$117.85																																																						
25-49	\$111.65																																																						
50+	\$106.68																																																						
PRICE																																																							
1-9	\$220.65																																																						
10-24	\$209.62																																																						
25-49	\$198.59																																																						
50+	\$189.76																																																						
PRICE																																																							
1-24	\$52.98																																																						
25-49	\$50.33																																																						
50-99	\$47.68																																																						
100+	\$45.56																																																						
PRICE																																																							
1-24	\$71.18																																																						
25-49	\$67.62																																																						
50-99	\$64.06																																																						
100+	\$61.21																																																						
5	 <table border="1"> <thead> <tr> <th colspan="2">PRICE</th> </tr> </thead> <tbody> <tr> <td>1-24</td> <td>\$62.97</td> </tr> <tr> <td>25-49</td> <td>\$59.82</td> </tr> <tr> <td>50-99</td> <td>\$56.67</td> </tr> <tr> <td>100+</td> <td>\$54.15</td> </tr> </tbody> </table> <p>SMA Female to SSMB Plug Model No: PE9402</p>	PRICE		1-24	\$62.97	25-49	\$59.82	50-99	\$56.67	100+	\$54.15	 <table border="1"> <thead> <tr> <th colspan="2">PRICE</th> </tr> </thead> <tbody> <tr> <td>1-24</td> <td>\$57.92</td> </tr> <tr> <td>25-49</td> <td>\$55.02</td> </tr> <tr> <td>50-99</td> <td>\$52.13</td> </tr> <tr> <td>100+</td> <td>\$49.81</td> </tr> </tbody> </table> <p>NEW SMA Female to SSMC Plug VSWR 1.25:1 to 3 GHz Model No: PE91380</p>	PRICE		1-24	\$57.92	25-49	\$55.02	50-99	\$52.13	100+	\$49.81	 <table border="1"> <thead> <tr> <th colspan="2">PRICE</th> </tr> </thead> <tbody> <tr> <td>1-24</td> <td>\$59.34</td> </tr> <tr> <td>25-49</td> <td>\$56.37</td> </tr> <tr> <td>50-99</td> <td>\$53.41</td> </tr> <tr> <td>100+</td> <td>\$51.03</td> </tr> </tbody> </table> <p>NEW SMA Female to SSMC Jack VSWR 1.25:1 to 3 GHz Model No: PE91433</p>	PRICE		1-24	\$59.34	25-49	\$56.37	50-99	\$53.41	100+	\$51.03	 <table border="1"> <thead> <tr> <th colspan="2">PRICE</th> </tr> </thead> <tbody> <tr> <td>1-24</td> <td>\$20.02</td> </tr> <tr> <td>25-49</td> <td>\$19.02</td> </tr> <tr> <td>50-99</td> <td>\$18.02</td> </tr> <tr> <td>100+</td> <td>\$17.22</td> </tr> </tbody> </table> <p>SMA Female to TNC Male VSWR 1.3:1 to 11 GHz Model No: PE9077</p>	PRICE		1-24	\$20.02	25-49	\$19.02	50-99	\$18.02	100+	\$17.22	 <table border="1"> <thead> <tr> <th colspan="2">PRICE</th> </tr> </thead> <tbody> <tr> <td>1-9</td> <td>\$116.95</td> </tr> <tr> <td>10-24</td> <td>\$111.10</td> </tr> <tr> <td>25-49</td> <td>\$105.26</td> </tr> <tr> <td>50+</td> <td>\$100.58</td> </tr> </tbody> </table> <p>SMA Female to TNC Male VSWR 1.25:1 to 18 GHz Model No: PE9440</p>	PRICE		1-9	\$116.95	10-24	\$111.10	25-49	\$105.26	50+	\$100.58
	PRICE																																																						
1-24	\$62.97																																																						
25-49	\$59.82																																																						
50-99	\$56.67																																																						
100+	\$54.15																																																						
PRICE																																																							
1-24	\$57.92																																																						
25-49	\$55.02																																																						
50-99	\$52.13																																																						
100+	\$49.81																																																						
PRICE																																																							
1-24	\$59.34																																																						
25-49	\$56.37																																																						
50-99	\$53.41																																																						
100+	\$51.03																																																						
PRICE																																																							
1-24	\$20.02																																																						
25-49	\$19.02																																																						
50-99	\$18.02																																																						
100+	\$17.22																																																						
PRICE																																																							
1-9	\$116.95																																																						
10-24	\$111.10																																																						
25-49	\$105.26																																																						
50+	\$100.58																																																						
6	 <table border="1"> <thead> <tr> <th colspan="2">PRICE</th> </tr> </thead> <tbody> <tr> <td>1-24</td> <td>\$47.98</td> </tr> <tr> <td>25-49</td> <td>\$45.58</td> </tr> <tr> <td>50-99</td> <td>\$43.18</td> </tr> <tr> <td>100+</td> <td>\$41.26</td> </tr> </tbody> </table> <p>SMA Female to TNC Female Max. Freq. 11 GHz Model No: PE9079</p>	PRICE		1-24	\$47.98	25-49	\$45.58	50-99	\$43.18	100+	\$41.26	 <table border="1"> <thead> <tr> <th colspan="2">PRICE</th> </tr> </thead> <tbody> <tr> <td>1-9</td> <td>\$141.75</td> </tr> <tr> <td>10-24</td> <td>\$134.66</td> </tr> <tr> <td>25-49</td> <td>\$127.58</td> </tr> <tr> <td>50+</td> <td>\$121.91</td> </tr> </tbody> </table> <p>SMA Female to TNC Female VSWR 1.25:1 to 18 GHz Model No: PE9442</p>	PRICE		1-9	\$141.75	10-24	\$134.66	25-49	\$127.58	50+	\$121.91	 <table border="1"> <thead> <tr> <th colspan="2">PRICE</th> </tr> </thead> <tbody> <tr> <td>1-24</td> <td>\$50.78</td> </tr> <tr> <td>25-49</td> <td>\$48.24</td> </tr> <tr> <td>50-99</td> <td>\$45.70</td> </tr> <tr> <td>100+</td> <td>\$43.67</td> </tr> </tbody> </table> <p>SMA Female to TNC Female Bulkhead VSWR 1.3:1 to 11 GHz Model No: PE9251</p>	PRICE		1-24	\$50.78	25-49	\$48.24	50-99	\$45.70	100+	\$43.67	 <table border="1"> <thead> <tr> <th colspan="2">PRICE</th> </tr> </thead> <tbody> <tr> <td>1-24</td> <td>\$53.03</td> </tr> <tr> <td>25-49</td> <td>\$50.38</td> </tr> <tr> <td>50-99</td> <td>\$47.73</td> </tr> <tr> <td>100+</td> <td>\$45.61</td> </tr> </tbody> </table> <p>SMA Female to TNC Female 4 Hole Flange-Mounting Hole A03 Model No: PE9276</p>	PRICE		1-24	\$53.03	25-49	\$50.38	50-99	\$47.73	100+	\$45.61	 <table border="1"> <thead> <tr> <th colspan="2">PRICE</th> </tr> </thead> <tbody> <tr> <td>1-24</td> <td>\$58.50</td> </tr> <tr> <td>25-49</td> <td>\$55.58</td> </tr> <tr> <td>50-99</td> <td>\$52.65</td> </tr> <tr> <td>100+</td> <td>\$50.31</td> </tr> </tbody> </table> <p>SMA Female to UHF Male VSWR 1.3:1 to 300 MHz Model No: PE9415</p>	PRICE		1-24	\$58.50	25-49	\$55.58	50-99	\$52.65	100+	\$50.31
	PRICE																																																						
1-24	\$47.98																																																						
25-49	\$45.58																																																						
50-99	\$43.18																																																						
100+	\$41.26																																																						
PRICE																																																							
1-9	\$141.75																																																						
10-24	\$134.66																																																						
25-49	\$127.58																																																						
50+	\$121.91																																																						
PRICE																																																							
1-24	\$50.78																																																						
25-49	\$48.24																																																						
50-99	\$45.70																																																						
100+	\$43.67																																																						
PRICE																																																							
1-24	\$53.03																																																						
25-49	\$50.38																																																						
50-99	\$47.73																																																						
100+	\$45.61																																																						
PRICE																																																							
1-24	\$58.50																																																						
25-49	\$55.58																																																						
50-99	\$52.65																																																						
100+	\$50.31																																																						
7	 <table border="1"> <thead> <tr> <th colspan="2">PRICE</th> </tr> </thead> <tbody> <tr> <td>1-24</td> <td>\$24.07</td> </tr> <tr> <td>25-49</td> <td>\$22.87</td> </tr> <tr> <td>50-99</td> <td>\$21.66</td> </tr> <tr> <td>100+</td> <td>\$20.70</td> </tr> </tbody> </table> <p>SMA Female to UMCX Plug VSWR 1.3:1 to 6 GHz Model No: PE91005</p>	PRICE		1-24	\$24.07	25-49	\$22.87	50-99	\$21.66	100+	\$20.70	 <table border="1"> <thead> <tr> <th colspan="2">PRICE</th> </tr> </thead> <tbody> <tr> <td>1-24</td> <td>\$29.85</td> </tr> <tr> <td>25-49</td> <td>\$28.36</td> </tr> <tr> <td>50-99</td> <td>\$26.87</td> </tr> <tr> <td>100+</td> <td>\$25.67</td> </tr> </tbody> </table> <p>SMA Female to UMCX Jack VSWR 1.3:1 to 6 GHz Model No: PE91006</p>	PRICE		1-24	\$29.85	25-49	\$28.36	50-99	\$26.87	100+	\$25.67	<p>Reverse Polarity SMA Between Series</p> <p>→</p>		 <table border="1"> <thead> <tr> <th colspan="2">PRICE</th> </tr> </thead> <tbody> <tr> <td>1-24</td> <td>\$82.08</td> </tr> <tr> <td>25-49</td> <td>\$77.98</td> </tr> <tr> <td>50-99</td> <td>\$73.87</td> </tr> <tr> <td>100+</td> <td>\$70.59</td> </tr> </tbody> </table> <p>SMA Male to Rev. Pol. MCX Plug VSWR 1.2:1 to 6 GHz Model No: PE9581</p>	PRICE		1-24	\$82.08	25-49	\$77.98	50-99	\$73.87	100+	\$70.59	 <table border="1"> <thead> <tr> <th colspan="2">PRICE</th> </tr> </thead> <tbody> <tr> <td>1-24</td> <td>\$59.26</td> </tr> <tr> <td>25-49</td> <td>\$56.30</td> </tr> <tr> <td>50-99</td> <td>\$53.33</td> </tr> <tr> <td>100+</td> <td>\$50.96</td> </tr> </tbody> </table> <p>SMA Male to Rev. Pol. TNC Female VSWR 1.25:1 to 11 GHz Model No: PE9600</p>	PRICE		1-24	\$59.26	25-49	\$56.30	50-99	\$53.33	100+	\$50.96									
	PRICE																																																						
1-24	\$24.07																																																						
25-49	\$22.87																																																						
50-99	\$21.66																																																						
100+	\$20.70																																																						
PRICE																																																							
1-24	\$29.85																																																						
25-49	\$28.36																																																						
50-99	\$26.87																																																						
100+	\$25.67																																																						
PRICE																																																							
1-24	\$82.08																																																						
25-49	\$77.98																																																						
50-99	\$73.87																																																						
100+	\$70.59																																																						
PRICE																																																							
1-24	\$59.26																																																						
25-49	\$56.30																																																						
50-99	\$53.33																																																						
100+	\$50.96																																																						

ADAPTERS

See Adapter Locator on Pages 8-13

See Page 369 for Mounting Holes

Adapters

See Our Website For Current Pricing & Real-Time Stock Availability!

	A	B	C	D	E																																																		
1	 <table border="1"> <thead> <tr> <th colspan="2">PRICE</th> </tr> </thead> <tbody> <tr> <td>1-24</td> <td>\$56.97</td> </tr> <tr> <td>25-49</td> <td>\$54.12</td> </tr> <tr> <td>50-99</td> <td>\$51.27</td> </tr> <tr> <td>100+</td> <td>\$48.99</td> </tr> </tbody> </table> <p>SMA Female to Rev. Pol. TNC Male Max. Freq. 11 GHz Model No: PE9602</p>	PRICE		1-24	\$56.97	25-49	\$54.12	50-99	\$51.27	100+	\$48.99	 <table border="1"> <thead> <tr> <th colspan="2">PRICE</th> </tr> </thead> <tbody> <tr> <td>1-24</td> <td>\$74.24</td> </tr> <tr> <td>25-49</td> <td>\$70.53</td> </tr> <tr> <td>50-99</td> <td>\$66.82</td> </tr> <tr> <td>100+</td> <td>\$63.85</td> </tr> </tbody> </table> <p>SMA Female to Rev. Pol. TNC Female VSWR 1.25:1 to 11 GHz Model No: PE9603</p>	PRICE		1-24	\$74.24	25-49	\$70.53	50-99	\$66.82	100+	\$63.85	 <table border="1"> <thead> <tr> <th colspan="2">PRICE</th> </tr> </thead> <tbody> <tr> <td>1-24</td> <td>\$77.28</td> </tr> <tr> <td>25-49</td> <td>\$73.42</td> </tr> <tr> <td>50-99</td> <td>\$69.55</td> </tr> <tr> <td>100+</td> <td>\$66.46</td> </tr> </tbody> </table> <p>Rev. Pol. SMA Male to N Female VSWR 1.25:1 to 11 GHz Model No: PE9732</p>	PRICE		1-24	\$77.28	25-49	\$73.42	50-99	\$69.55	100+	\$66.46	 <table border="1"> <thead> <tr> <th colspan="2">PRICE</th> </tr> </thead> <tbody> <tr> <td>1-24</td> <td>\$65.30</td> </tr> <tr> <td>25-49</td> <td>\$62.04</td> </tr> <tr> <td>50-99</td> <td>\$58.77</td> </tr> <tr> <td>100+</td> <td>\$56.16</td> </tr> </tbody> </table> <p>Rev. Pol. SMA Male to TNC Male VSWR 1.2:1 to 11 GHz Model No: PE9597</p>	PRICE		1-24	\$65.30	25-49	\$62.04	50-99	\$58.77	100+	\$56.16	 <table border="1"> <thead> <tr> <th colspan="2">PRICE</th> </tr> </thead> <tbody> <tr> <td>1-24</td> <td>\$62.87</td> </tr> <tr> <td>25-49</td> <td>\$59.73</td> </tr> <tr> <td>50-99</td> <td>\$56.58</td> </tr> <tr> <td>100+</td> <td>\$54.07</td> </tr> </tbody> </table> <p>Rev. Pol. SMA Male to TNC Female VSWR 1.2:1 to 11 GHz Model No: PE9596</p>	PRICE		1-24	\$62.87	25-49	\$59.73	50-99	\$56.58	100+	\$54.07
PRICE																																																							
1-24	\$56.97																																																						
25-49	\$54.12																																																						
50-99	\$51.27																																																						
100+	\$48.99																																																						
PRICE																																																							
1-24	\$74.24																																																						
25-49	\$70.53																																																						
50-99	\$66.82																																																						
100+	\$63.85																																																						
PRICE																																																							
1-24	\$77.28																																																						
25-49	\$73.42																																																						
50-99	\$69.55																																																						
100+	\$66.46																																																						
PRICE																																																							
1-24	\$65.30																																																						
25-49	\$62.04																																																						
50-99	\$58.77																																																						
100+	\$56.16																																																						
PRICE																																																							
1-24	\$62.87																																																						
25-49	\$59.73																																																						
50-99	\$56.58																																																						
100+	\$54.07																																																						
2	 <table border="1"> <thead> <tr> <th colspan="2">PRICE</th> </tr> </thead> <tbody> <tr> <td>1-24</td> <td>\$84.23</td> </tr> <tr> <td>25-49</td> <td>\$80.02</td> </tr> <tr> <td>50-99</td> <td>\$75.81</td> </tr> <tr> <td>100+</td> <td>\$72.44</td> </tr> </tbody> </table> <p>Rev. Pol. SMA Female to N Male VSWR 1.25:1 to 11 GHz Model No: PE9733</p>	PRICE		1-24	\$84.23	25-49	\$80.02	50-99	\$75.81	100+	\$72.44	 <table border="1"> <thead> <tr> <th colspan="2">PRICE</th> </tr> </thead> <tbody> <tr> <td>1-24</td> <td>\$64.03</td> </tr> <tr> <td>25-49</td> <td>\$60.83</td> </tr> <tr> <td>50-99</td> <td>\$57.63</td> </tr> <tr> <td>100+</td> <td>\$55.07</td> </tr> </tbody> </table> <p>Rev. Pol. SMA Female to TNC Male VSWR 1.2:1 to 11 GHz Model No: PE9598</p>	PRICE		1-24	\$64.03	25-49	\$60.83	50-99	\$57.63	100+	\$55.07	 <table border="1"> <thead> <tr> <th colspan="2">PRICE</th> </tr> </thead> <tbody> <tr> <td>1-24</td> <td>\$65.30</td> </tr> <tr> <td>25-49</td> <td>\$62.04</td> </tr> <tr> <td>50-99</td> <td>\$58.77</td> </tr> <tr> <td>100+</td> <td>\$56.16</td> </tr> </tbody> </table> <p>Rev. Pol. SMA Female to TNC Female VSWR 1.2:1 to 11 GHz Model No: PE9599</p>	PRICE		1-24	\$65.30	25-49	\$62.04	50-99	\$58.77	100+	\$56.16	 <table border="1"> <thead> <tr> <th colspan="2">PRICE</th> </tr> </thead> <tbody> <tr> <td>1-24</td> <td>\$65.30</td> </tr> <tr> <td>25-49</td> <td>\$62.04</td> </tr> <tr> <td>50-99</td> <td>\$58.77</td> </tr> <tr> <td>100+</td> <td>\$56.16</td> </tr> </tbody> </table> <p>Rev. Pol. SMA Male to Rev. Pol. TNC Male VSWR 1.2:1 to 11 GHz Model No: PE9605</p>	PRICE		1-24	\$65.30	25-49	\$62.04	50-99	\$58.77	100+	\$56.16	 <table border="1"> <thead> <tr> <th colspan="2">PRICE</th> </tr> </thead> <tbody> <tr> <td>1-24</td> <td>\$83.50</td> </tr> <tr> <td>25-49</td> <td>\$79.33</td> </tr> <tr> <td>50-99</td> <td>\$75.15</td> </tr> <tr> <td>100+</td> <td>\$71.81</td> </tr> </tbody> </table> <p>Rev. Pol. SMA Male to Rev. Pol. TNC Female VSWR 1.25:1 to 11 GHz Model No: PE9604</p>	PRICE		1-24	\$83.50	25-49	\$79.33	50-99	\$75.15	100+	\$71.81
PRICE																																																							
1-24	\$84.23																																																						
25-49	\$80.02																																																						
50-99	\$75.81																																																						
100+	\$72.44																																																						
PRICE																																																							
1-24	\$64.03																																																						
25-49	\$60.83																																																						
50-99	\$57.63																																																						
100+	\$55.07																																																						
PRICE																																																							
1-24	\$65.30																																																						
25-49	\$62.04																																																						
50-99	\$58.77																																																						
100+	\$56.16																																																						
PRICE																																																							
1-24	\$65.30																																																						
25-49	\$62.04																																																						
50-99	\$58.77																																																						
100+	\$56.16																																																						
PRICE																																																							
1-24	\$83.50																																																						
25-49	\$79.33																																																						
50-99	\$75.15																																																						
100+	\$71.81																																																						
3	 <table border="1"> <thead> <tr> <th colspan="2">PRICE</th> </tr> </thead> <tbody> <tr> <td>1-24</td> <td>\$65.30</td> </tr> <tr> <td>25-49</td> <td>\$62.04</td> </tr> <tr> <td>50-99</td> <td>\$58.77</td> </tr> <tr> <td>100+</td> <td>\$56.16</td> </tr> </tbody> </table> <p>Rev. Pol. SMA Female to Rev. Pol. TNC Male VSWR 1.2:1 to 11 GHz Model No: PE9607</p>	PRICE		1-24	\$65.30	25-49	\$62.04	50-99	\$58.77	100+	\$56.16	 <table border="1"> <thead> <tr> <th colspan="2">PRICE</th> </tr> </thead> <tbody> <tr> <td>1-24</td> <td>\$65.30</td> </tr> <tr> <td>25-49</td> <td>\$62.04</td> </tr> <tr> <td>50-99</td> <td>\$58.77</td> </tr> <tr> <td>100+</td> <td>\$56.16</td> </tr> </tbody> </table> <p>Rev. Pol. SMA Female to Rev. Pol. TNC Female VSWR 1.25:1 to 11 GHz Model No: PE9606</p>	PRICE		1-24	\$65.30	25-49	\$62.04	50-99	\$58.77	100+	\$56.16	<p>SMB In-Series</p> 		 <table border="1"> <thead> <tr> <th colspan="2">PRICE</th> </tr> </thead> <tbody> <tr> <td>1-24</td> <td>\$36.17</td> </tr> <tr> <td>25-49</td> <td>\$34.36</td> </tr> <tr> <td>50-99</td> <td>\$32.55</td> </tr> <tr> <td>100+</td> <td>\$31.11</td> </tr> </tbody> </table> <p>SMB Plug to SMB Plug Max. Freq. 4 GHz Model No: PE9118</p>	PRICE		1-24	\$36.17	25-49	\$34.36	50-99	\$32.55	100+	\$31.11	 <table border="1"> <thead> <tr> <th colspan="2">PRICE</th> </tr> </thead> <tbody> <tr> <td>1-24</td> <td>\$93.26</td> </tr> <tr> <td>25-49</td> <td>\$88.60</td> </tr> <tr> <td>50-99</td> <td>\$83.93</td> </tr> <tr> <td>100+</td> <td>\$80.20</td> </tr> </tbody> </table> <p>SMB Plug to SMB Plug Tee Max. Freq. 4 GHz Model No: PE9310</p>	PRICE		1-24	\$93.26	25-49	\$88.60	50-99	\$83.93	100+	\$80.20									
PRICE																																																							
1-24	\$65.30																																																						
25-49	\$62.04																																																						
50-99	\$58.77																																																						
100+	\$56.16																																																						
PRICE																																																							
1-24	\$65.30																																																						
25-49	\$62.04																																																						
50-99	\$58.77																																																						
100+	\$56.16																																																						
PRICE																																																							
1-24	\$36.17																																																						
25-49	\$34.36																																																						
50-99	\$32.55																																																						
100+	\$31.11																																																						
PRICE																																																							
1-24	\$93.26																																																						
25-49	\$88.60																																																						
50-99	\$83.93																																																						
100+	\$80.20																																																						
4	 <table border="1"> <thead> <tr> <th colspan="2">PRICE</th> </tr> </thead> <tbody> <tr> <td>1-24</td> <td>\$62.86</td> </tr> <tr> <td>25-49</td> <td>\$59.72</td> </tr> <tr> <td>50-99</td> <td>\$56.57</td> </tr> <tr> <td>100+</td> <td>\$54.06</td> </tr> </tbody> </table> <p>SMB Plug to SMB Jack VSWR 1.2:1 to 4 GHz Model No: PE9120</p>	PRICE		1-24	\$62.86	25-49	\$59.72	50-99	\$56.57	100+	\$54.06	 <table border="1"> <thead> <tr> <th colspan="2">PRICE</th> </tr> </thead> <tbody> <tr> <td>1-24</td> <td>\$70.80</td> </tr> <tr> <td>25-49</td> <td>\$67.26</td> </tr> <tr> <td>50-99</td> <td>\$63.72</td> </tr> <tr> <td>100+</td> <td>\$60.89</td> </tr> </tbody> </table> <p>SMB Plug to SMB Jack Tee Model No: PE9309</p>	PRICE		1-24	\$70.80	25-49	\$67.26	50-99	\$63.72	100+	\$60.89	 <table border="1"> <thead> <tr> <th colspan="2">PRICE</th> </tr> </thead> <tbody> <tr> <td>1-24</td> <td>\$41.48</td> </tr> <tr> <td>25-49</td> <td>\$39.41</td> </tr> <tr> <td>50-99</td> <td>\$37.33</td> </tr> <tr> <td>100+</td> <td>\$35.67</td> </tr> </tbody> </table> <p>SMB Jack to SMB Plug Tee Max. Freq. 100 MHz Model No: PE9243</p>	PRICE		1-24	\$41.48	25-49	\$39.41	50-99	\$37.33	100+	\$35.67	 <table border="1"> <thead> <tr> <th colspan="2">PRICE</th> </tr> </thead> <tbody> <tr> <td>1-24</td> <td>\$50.65</td> </tr> <tr> <td>25-49</td> <td>\$48.12</td> </tr> <tr> <td>50-99</td> <td>\$45.59</td> </tr> <tr> <td>100+</td> <td>\$43.56</td> </tr> </tbody> </table> <p>SMB Jack to SMB Jack VSWR 1.3:1 to 4 GHz Model No: PE9116</p>	PRICE		1-24	\$50.65	25-49	\$48.12	50-99	\$45.59	100+	\$43.56	 <table border="1"> <thead> <tr> <th colspan="2">PRICE</th> </tr> </thead> <tbody> <tr> <td>1-24</td> <td>\$50.13</td> </tr> <tr> <td>25-49</td> <td>\$47.62</td> </tr> <tr> <td>50-99</td> <td>\$45.12</td> </tr> <tr> <td>100+</td> <td>\$43.11</td> </tr> </tbody> </table> <p>SMB Jack to SMB Jack Tee Model No: PE9302</p>	PRICE		1-24	\$50.13	25-49	\$47.62	50-99	\$45.12	100+	\$43.11
PRICE																																																							
1-24	\$62.86																																																						
25-49	\$59.72																																																						
50-99	\$56.57																																																						
100+	\$54.06																																																						
PRICE																																																							
1-24	\$70.80																																																						
25-49	\$67.26																																																						
50-99	\$63.72																																																						
100+	\$60.89																																																						
PRICE																																																							
1-24	\$41.48																																																						
25-49	\$39.41																																																						
50-99	\$37.33																																																						
100+	\$35.67																																																						
PRICE																																																							
1-24	\$50.65																																																						
25-49	\$48.12																																																						
50-99	\$45.59																																																						
100+	\$43.56																																																						
PRICE																																																							
1-24	\$50.13																																																						
25-49	\$47.62																																																						
50-99	\$45.12																																																						
100+	\$43.11																																																						
5	 <table border="1"> <thead> <tr> <th colspan="2">PRICE</th> </tr> </thead> <tbody> <tr> <td>1-24</td> <td>\$34.77</td> </tr> <tr> <td>25-49</td> <td>\$33.03</td> </tr> <tr> <td>50-99</td> <td>\$31.29</td> </tr> <tr> <td>100+</td> <td>\$29.90</td> </tr> </tbody> </table> <p>SMB Jack to SMB Jack Bulkhead-Mounting Hole B01 Max. Freq. 4 GHz Model No: PE9122</p>	PRICE		1-24	\$34.77	25-49	\$33.03	50-99	\$31.29	100+	\$29.90	<p>SMB Between Series</p> 		 <table border="1"> <thead> <tr> <th colspan="2">PRICE</th> </tr> </thead> <tbody> <tr> <td>1-24</td> <td>\$56.29</td> </tr> <tr> <td>25-49</td> <td>\$53.48</td> </tr> <tr> <td>50-99</td> <td>\$50.66</td> </tr> <tr> <td>100+</td> <td>\$48.41</td> </tr> </tbody> </table> <p>SMB Plug to BNC Male Max. Freq. 4 GHz Model No: PE9135</p>	PRICE		1-24	\$56.29	25-49	\$53.48	50-99	\$50.66	100+	\$48.41	 <table border="1"> <thead> <tr> <th colspan="2">PRICE</th> </tr> </thead> <tbody> <tr> <td>1-24</td> <td>\$59.31</td> </tr> <tr> <td>25-49</td> <td>\$56.34</td> </tr> <tr> <td>50-99</td> <td>\$53.38</td> </tr> <tr> <td>100+</td> <td>\$51.01</td> </tr> </tbody> </table> <p>SMB Plug to BNC Female VSWR 1.3:1 to 4 GHz Model No: PE9137</p>	PRICE		1-24	\$59.31	25-49	\$56.34	50-99	\$53.38	100+	\$51.01	 <table border="1"> <thead> <tr> <th colspan="2">PRICE</th> </tr> </thead> <tbody> <tr> <td>1-24</td> <td>\$49.94</td> </tr> <tr> <td>25-49</td> <td>\$47.44</td> </tr> <tr> <td>50-99</td> <td>\$44.95</td> </tr> <tr> <td>100+</td> <td>\$42.95</td> </tr> </tbody> </table> <p>SMB Plug to BNC Female Bulkhead-Mounting Hole B05 Max. Freq. 3 GHz Model No: PE9241</p>	PRICE		1-24	\$49.94	25-49	\$47.44	50-99	\$44.95	100+	\$42.95									
PRICE																																																							
1-24	\$34.77																																																						
25-49	\$33.03																																																						
50-99	\$31.29																																																						
100+	\$29.90																																																						
PRICE																																																							
1-24	\$56.29																																																						
25-49	\$53.48																																																						
50-99	\$50.66																																																						
100+	\$48.41																																																						
PRICE																																																							
1-24	\$59.31																																																						
25-49	\$56.34																																																						
50-99	\$53.38																																																						
100+	\$51.01																																																						
PRICE																																																							
1-24	\$49.94																																																						
25-49	\$47.44																																																						
50-99	\$44.95																																																						
100+	\$42.95																																																						
6	 <table border="1"> <thead> <tr> <th colspan="2">PRICE</th> </tr> </thead> <tbody> <tr> <td>1-24</td> <td>\$56.28</td> </tr> <tr> <td>25-49</td> <td>\$53.47</td> </tr> <tr> <td>50-99</td> <td>\$50.65</td> </tr> <tr> <td>100+</td> <td>\$48.40</td> </tr> </tbody> </table> <p>SMB Jack to BNC Male Max. Freq. 4 GHz Model No: PE9132</p>	PRICE		1-24	\$56.28	25-49	\$53.47	50-99	\$50.65	100+	\$48.40	 <table border="1"> <thead> <tr> <th colspan="2">PRICE</th> </tr> </thead> <tbody> <tr> <td>1-24</td> <td>\$58.25</td> </tr> <tr> <td>25-49</td> <td>\$55.34</td> </tr> <tr> <td>50-99</td> <td>\$52.43</td> </tr> <tr> <td>100+</td> <td>\$50.10</td> </tr> </tbody> </table> <p>SMB Jack to BNC Female Max. Freq. 4 GHz Model No: PE9136</p>	PRICE		1-24	\$58.25	25-49	\$55.34	50-99	\$52.43	100+	\$50.10	 <table border="1"> <thead> <tr> <th colspan="2">PRICE</th> </tr> </thead> <tbody> <tr> <td>1-24</td> <td>\$53.02</td> </tr> <tr> <td>25-49</td> <td>\$50.37</td> </tr> <tr> <td>50-99</td> <td>\$47.72</td> </tr> <tr> <td>100+</td> <td>\$45.60</td> </tr> </tbody> </table> <p>SMB Jack to BNC Female Bulkhead VSWR 1.3:1 to 4 GHz Model No: PE9240</p>	PRICE		1-24	\$53.02	25-49	\$50.37	50-99	\$47.72	100+	\$45.60	<p>SMC In-Series</p> 		 <table border="1"> <thead> <tr> <th colspan="2">PRICE</th> </tr> </thead> <tbody> <tr> <td>1-24</td> <td>\$32.63</td> </tr> <tr> <td>25-49</td> <td>\$31.00</td> </tr> <tr> <td>50-99</td> <td>\$29.37</td> </tr> <tr> <td>100+</td> <td>\$28.06</td> </tr> </tbody> </table> <p>SMC Plug to SMC Plug Max. Freq. 6 GHz Model No: PE9117</p>	PRICE		1-24	\$32.63	25-49	\$31.00	50-99	\$29.37	100+	\$28.06									
PRICE																																																							
1-24	\$56.28																																																						
25-49	\$53.47																																																						
50-99	\$50.65																																																						
100+	\$48.40																																																						
PRICE																																																							
1-24	\$58.25																																																						
25-49	\$55.34																																																						
50-99	\$52.43																																																						
100+	\$50.10																																																						
PRICE																																																							
1-24	\$53.02																																																						
25-49	\$50.37																																																						
50-99	\$47.72																																																						
100+	\$45.60																																																						
PRICE																																																							
1-24	\$32.63																																																						
25-49	\$31.00																																																						
50-99	\$29.37																																																						
100+	\$28.06																																																						
7	 <table border="1"> <thead> <tr> <th colspan="2">PRICE</th> </tr> </thead> <tbody> <tr> <td>1-24</td> <td>\$56.51</td> </tr> <tr> <td>25-49</td> <td>\$53.68</td> </tr> <tr> <td>50-99</td> <td>\$50.86</td> </tr> <tr> <td>100+</td> <td>\$48.60</td> </tr> </tbody> </table> <p>SMC Plug to SMC Plug Tee Model No: PE9305</p>	PRICE		1-24	\$56.51	25-49	\$53.68	50-99	\$50.86	100+	\$48.60	 <table border="1"> <thead> <tr> <th colspan="2">PRICE</th> </tr> </thead> <tbody> <tr> <td>1-24</td> <td>\$48.44</td> </tr> <tr> <td>25-49</td> <td>\$46.02</td> </tr> <tr> <td>50-99</td> <td>\$43.60</td> </tr> <tr> <td>100+</td> <td>\$41.66</td> </tr> </tbody> </table> <p>SMC Plug to SMC Jack VSWR 1.2:1 to 10 GHz Model No: PE9119</p>	PRICE		1-24	\$48.44	25-49	\$46.02	50-99	\$43.60	100+	\$41.66	 <table border="1"> <thead> <tr> <th colspan="2">PRICE</th> </tr> </thead> <tbody> <tr> <td>1-24</td> <td>\$62.15</td> </tr> <tr> <td>25-49</td> <td>\$59.04</td> </tr> <tr> <td>50-99</td> <td>\$55.94</td> </tr> <tr> <td>100+</td> <td>\$53.45</td> </tr> </tbody> </table> <p>SMC Plug to SMC Jack Right Angle Model No: PE9303</p>	PRICE		1-24	\$62.15	25-49	\$59.04	50-99	\$55.94	100+	\$53.45	 <table border="1"> <thead> <tr> <th colspan="2">PRICE</th> </tr> </thead> <tbody> <tr> <td>1-24</td> <td>\$44.16</td> </tr> <tr> <td>25-49</td> <td>\$41.95</td> </tr> <tr> <td>50-99</td> <td>\$39.74</td> </tr> <tr> <td>100+</td> <td>\$37.98</td> </tr> </tbody> </table> <p>SMC Jack to SMC Plug Tee Max. Freq. 100 MHz Model No: PE9242</p>	PRICE		1-24	\$44.16	25-49	\$41.95	50-99	\$39.74	100+	\$37.98	 <table border="1"> <thead> <tr> <th colspan="2">PRICE</th> </tr> </thead> <tbody> <tr> <td>1-24</td> <td>\$31.39</td> </tr> <tr> <td>25-49</td> <td>\$29.82</td> </tr> <tr> <td>50-99</td> <td>\$28.25</td> </tr> <tr> <td>100+</td> <td>\$27.00</td> </tr> </tbody> </table> <p>SMC Jack to SMC Jack Tee Model No: PE9115</p>	PRICE		1-24	\$31.39	25-49	\$29.82	50-99	\$28.25	100+	\$27.00
PRICE																																																							
1-24	\$56.51																																																						
25-49	\$53.68																																																						
50-99	\$50.86																																																						
100+	\$48.60																																																						
PRICE																																																							
1-24	\$48.44																																																						
25-49	\$46.02																																																						
50-99	\$43.60																																																						
100+	\$41.66																																																						
PRICE																																																							
1-24	\$62.15																																																						
25-49	\$59.04																																																						
50-99	\$55.94																																																						
100+	\$53.45																																																						
PRICE																																																							
1-24	\$44.16																																																						
25-49	\$41.95																																																						
50-99	\$39.74																																																						
100+	\$37.98																																																						
PRICE																																																							
1-24	\$31.39																																																						
25-49	\$29.82																																																						
50-99	\$28.25																																																						
100+	\$27.00																																																						

ADAPTERS

See Adapter Locator on Pages 8-13

See Page 369 for Mounting Holes

	A	B	C	D	E																																																		
1	 <table border="1"> <thead> <tr><th colspan="2">PRICE</th></tr> </thead> <tbody> <tr><td>1-24</td><td>\$64.71</td></tr> <tr><td>25-49</td><td>\$61.47</td></tr> <tr><td>50-99</td><td>\$58.24</td></tr> <tr><td>100+</td><td>\$55.65</td></tr> </tbody> </table> <p>SMC Jack to SMC Jack Tee</p> <p>Model No: PE9304</p>	PRICE		1-24	\$64.71	25-49	\$61.47	50-99	\$58.24	100+	\$55.65	 <table border="1"> <thead> <tr><th colspan="2">PRICE</th></tr> </thead> <tbody> <tr><td>1-24</td><td>\$33.15</td></tr> <tr><td>25-49</td><td>\$31.49</td></tr> <tr><td>50-99</td><td>\$29.84</td></tr> <tr><td>100+</td><td>\$28.51</td></tr> </tbody> </table> <p>NEW</p> <p>SMC Jack to SMC Jack Bulkhead-Mounting Hole B01 Max. Freq. 10 GHz</p> <p>Model No: PE91403</p>	PRICE		1-24	\$33.15	25-49	\$31.49	50-99	\$29.84	100+	\$28.51	<p>SMC <i>Between Series</i></p> <p>→</p>		 <table border="1"> <thead> <tr><th colspan="2">PRICE</th></tr> </thead> <tbody> <tr><td>1-24</td><td>\$57.18</td></tr> <tr><td>25-49</td><td>\$54.32</td></tr> <tr><td>50-99</td><td>\$51.46</td></tr> <tr><td>100+</td><td>\$49.17</td></tr> </tbody> </table> <p>SMC Plug to BNC Male</p> <p>Model No: PE9139</p>	PRICE		1-24	\$57.18	25-49	\$54.32	50-99	\$51.46	100+	\$49.17	 <table border="1"> <thead> <tr><th colspan="2">PRICE</th></tr> </thead> <tbody> <tr><td>1-24</td><td>\$56.29</td></tr> <tr><td>25-49</td><td>\$53.48</td></tr> <tr><td>50-99</td><td>\$50.66</td></tr> <tr><td>100+</td><td>\$48.41</td></tr> </tbody> </table> <p>SMC Plug to BNC Female</p> <p>VSWR 1.3:1 to 4 GHz</p> <p>Model No: PE9141</p>	PRICE		1-24	\$56.29	25-49	\$53.48	50-99	\$50.66	100+	\$48.41									
	PRICE																																																						
1-24	\$64.71																																																						
25-49	\$61.47																																																						
50-99	\$58.24																																																						
100+	\$55.65																																																						
PRICE																																																							
1-24	\$33.15																																																						
25-49	\$31.49																																																						
50-99	\$29.84																																																						
100+	\$28.51																																																						
PRICE																																																							
1-24	\$57.18																																																						
25-49	\$54.32																																																						
50-99	\$51.46																																																						
100+	\$49.17																																																						
PRICE																																																							
1-24	\$56.29																																																						
25-49	\$53.48																																																						
50-99	\$50.66																																																						
100+	\$48.41																																																						
2	 <table border="1"> <thead> <tr><th colspan="2">PRICE</th></tr> </thead> <tbody> <tr><td>1-24</td><td>\$84.40</td></tr> <tr><td>25-49</td><td>\$80.18</td></tr> <tr><td>50-99</td><td>\$75.96</td></tr> <tr><td>100+</td><td>\$72.58</td></tr> </tbody> </table> <p>SMC Plug to SMB Plug</p> <p>Model No: PE9281</p>	PRICE		1-24	\$84.40	25-49	\$80.18	50-99	\$75.96	100+	\$72.58	 <table border="1"> <thead> <tr><th colspan="2">PRICE</th></tr> </thead> <tbody> <tr><td>1-24</td><td>\$46.42</td></tr> <tr><td>25-49</td><td>\$44.10</td></tr> <tr><td>50-99</td><td>\$41.78</td></tr> <tr><td>100+</td><td>\$39.92</td></tr> </tbody> </table> <p>SMC Plug to SMB Jack</p> <p>Model No: PE9284</p>	PRICE		1-24	\$46.42	25-49	\$44.10	50-99	\$41.78	100+	\$39.92	 <table border="1"> <thead> <tr><th colspan="2">PRICE</th></tr> </thead> <tbody> <tr><td>1-24</td><td>\$56.29</td></tr> <tr><td>25-49</td><td>\$53.48</td></tr> <tr><td>50-99</td><td>\$50.66</td></tr> <tr><td>100+</td><td>\$48.41</td></tr> </tbody> </table> <p>SMC Jack to BNC Male</p> <p>Model No: PE9138</p>	PRICE		1-24	\$56.29	25-49	\$53.48	50-99	\$50.66	100+	\$48.41	 <table border="1"> <thead> <tr><th colspan="2">PRICE</th></tr> </thead> <tbody> <tr><td>1-24</td><td>\$65.61</td></tr> <tr><td>25-49</td><td>\$62.33</td></tr> <tr><td>50-99</td><td>\$59.05</td></tr> <tr><td>100+</td><td>\$56.42</td></tr> </tbody> </table> <p>SMC Jack to BNC Female</p> <p>VSWR 1.35:1 to 4 GHz</p> <p>Model No: PE9140</p>	PRICE		1-24	\$65.61	25-49	\$62.33	50-99	\$59.05	100+	\$56.42	 <table border="1"> <thead> <tr><th colspan="2">PRICE</th></tr> </thead> <tbody> <tr><td>1-24</td><td>\$77.33</td></tr> <tr><td>25-49</td><td>\$73.46</td></tr> <tr><td>50-99</td><td>\$69.60</td></tr> <tr><td>100+</td><td>\$66.50</td></tr> </tbody> </table> <p>SMC Jack to BNC Female Bulkhead</p> <p>Model No: PE9108</p>	PRICE		1-24	\$77.33	25-49	\$73.46	50-99	\$69.60	100+	\$66.50
	PRICE																																																						
1-24	\$84.40																																																						
25-49	\$80.18																																																						
50-99	\$75.96																																																						
100+	\$72.58																																																						
PRICE																																																							
1-24	\$46.42																																																						
25-49	\$44.10																																																						
50-99	\$41.78																																																						
100+	\$39.92																																																						
PRICE																																																							
1-24	\$56.29																																																						
25-49	\$53.48																																																						
50-99	\$50.66																																																						
100+	\$48.41																																																						
PRICE																																																							
1-24	\$65.61																																																						
25-49	\$62.33																																																						
50-99	\$59.05																																																						
100+	\$56.42																																																						
PRICE																																																							
1-24	\$77.33																																																						
25-49	\$73.46																																																						
50-99	\$69.60																																																						
100+	\$66.50																																																						
3	 <table border="1"> <thead> <tr><th colspan="2">PRICE</th></tr> </thead> <tbody> <tr><td>1-24</td><td>\$54.55</td></tr> <tr><td>25-49</td><td>\$51.82</td></tr> <tr><td>50-99</td><td>\$49.10</td></tr> <tr><td>100+</td><td>\$46.91</td></tr> </tbody> </table> <p>SMC Jack to SMB Plug</p> <p>Model No: PE9282</p>	PRICE		1-24	\$54.55	25-49	\$51.82	50-99	\$49.10	100+	\$46.91	 <table border="1"> <thead> <tr><th colspan="2">PRICE</th></tr> </thead> <tbody> <tr><td>1-24</td><td>\$55.98</td></tr> <tr><td>25-49</td><td>\$53.18</td></tr> <tr><td>50-99</td><td>\$50.38</td></tr> <tr><td>100+</td><td>\$48.14</td></tr> </tbody> </table> <p>SMC Jack to SMB Jack</p> <p>Model No: PE9283</p>	PRICE		1-24	\$55.98	25-49	\$53.18	50-99	\$50.38	100+	\$48.14	<p>SMP <i>In-Series</i></p> <p>→</p>		 <table border="1"> <thead> <tr><th colspan="2">PRICE</th></tr> </thead> <tbody> <tr><td>1-24</td><td>\$20.98</td></tr> <tr><td>25-49</td><td>\$19.93</td></tr> <tr><td>50-99</td><td>\$18.88</td></tr> <tr><td>100+</td><td>\$18.04</td></tr> </tbody> </table> <p>SMP Female to SMP Female</p> <p>VSWR 1.2:1 to 12 GHz</p> <p>Model No: PE91102</p>	PRICE		1-24	\$20.98	25-49	\$19.93	50-99	\$18.88	100+	\$18.04	 <table border="1"> <thead> <tr><th colspan="2">PRICE</th></tr> </thead> <tbody> <tr><td>1-24</td><td>\$81.24</td></tr> <tr><td>25-49</td><td>\$77.18</td></tr> <tr><td>50-99</td><td>\$73.12</td></tr> <tr><td>100+</td><td>\$69.87</td></tr> </tbody> </table> <p>SMP Female to SMP Female</p> <p>Max. Freq. 26.5 GHz</p> <p>Model No: PE9776</p>	PRICE		1-24	\$81.24	25-49	\$77.18	50-99	\$73.12	100+	\$69.87									
	PRICE																																																						
1-24	\$54.55																																																						
25-49	\$51.82																																																						
50-99	\$49.10																																																						
100+	\$46.91																																																						
PRICE																																																							
1-24	\$55.98																																																						
25-49	\$53.18																																																						
50-99	\$50.38																																																						
100+	\$48.14																																																						
PRICE																																																							
1-24	\$20.98																																																						
25-49	\$19.93																																																						
50-99	\$18.88																																																						
100+	\$18.04																																																						
PRICE																																																							
1-24	\$81.24																																																						
25-49	\$77.18																																																						
50-99	\$73.12																																																						
100+	\$69.87																																																						
4	 <table border="1"> <thead> <tr><th colspan="2">PRICE</th></tr> </thead> <tbody> <tr><td>1-24</td><td>\$21.84</td></tr> <tr><td>25-49</td><td>\$20.75</td></tr> <tr><td>50-99</td><td>\$19.66</td></tr> <tr><td>100+</td><td>\$18.78</td></tr> </tbody> </table> <p>SMP Female to SMP Female</p> <p>VSWR 1.2:1 to 8 GHz</p> <p>Model No: PE91068</p>	PRICE		1-24	\$21.84	25-49	\$20.75	50-99	\$19.66	100+	\$18.78	 <table border="1"> <thead> <tr><th colspan="2">PRICE</th></tr> </thead> <tbody> <tr><td>1-24</td><td>\$33.30</td></tr> <tr><td>25-49</td><td>\$31.64</td></tr> <tr><td>50-99</td><td>\$29.97</td></tr> <tr><td>100+</td><td>\$28.64</td></tr> </tbody> </table> <p>SMP Female to SMP Female</p> <p>Max. Freq. 40 GHz</p> <p>Model No: PE91072</p>	PRICE		1-24	\$33.30	25-49	\$31.64	50-99	\$29.97	100+	\$28.64	 <table border="1"> <thead> <tr><th colspan="2">PRICE</th></tr> </thead> <tbody> <tr><td>1-24</td><td>\$33.56</td></tr> <tr><td>25-49</td><td>\$31.88</td></tr> <tr><td>50-99</td><td>\$30.20</td></tr> <tr><td>100+</td><td>\$28.86</td></tr> </tbody> </table> <p>SMP Female to SMP Female</p> <p>Max. Freq. 40 GHz</p> <p>Model No: PE91099</p>	PRICE		1-24	\$33.56	25-49	\$31.88	50-99	\$30.20	100+	\$28.86	 <table border="1"> <thead> <tr><th colspan="2">PRICE</th></tr> </thead> <tbody> <tr><td>1-24</td><td>\$13.98</td></tr> <tr><td>25-49</td><td>\$13.28</td></tr> <tr><td>50-99</td><td>\$12.58</td></tr> <tr><td>100+</td><td>\$12.02</td></tr> </tbody> </table> <p>SMP Female to SMP Female</p> <p>VSWR 1.2:1 to 8 GHz</p> <p>Model No: PE91101</p>	PRICE		1-24	\$13.98	25-49	\$13.28	50-99	\$12.58	100+	\$12.02	 <table border="1"> <thead> <tr><th colspan="2">PRICE</th></tr> </thead> <tbody> <tr><td>1-24</td><td>\$68.11</td></tr> <tr><td>25-49</td><td>\$64.70</td></tr> <tr><td>50-99</td><td>\$61.30</td></tr> <tr><td>100+</td><td>\$58.57</td></tr> </tbody> </table> <p>SMP Female to SMP Female</p> <p>Max. Freq. 26.5 GHz</p> <p>Model No: PE9775</p>	PRICE		1-24	\$68.11	25-49	\$64.70	50-99	\$61.30	100+	\$58.57
	PRICE																																																						
1-24	\$21.84																																																						
25-49	\$20.75																																																						
50-99	\$19.66																																																						
100+	\$18.78																																																						
PRICE																																																							
1-24	\$33.30																																																						
25-49	\$31.64																																																						
50-99	\$29.97																																																						
100+	\$28.64																																																						
PRICE																																																							
1-24	\$33.56																																																						
25-49	\$31.88																																																						
50-99	\$30.20																																																						
100+	\$28.86																																																						
PRICE																																																							
1-24	\$13.98																																																						
25-49	\$13.28																																																						
50-99	\$12.58																																																						
100+	\$12.02																																																						
PRICE																																																							
1-24	\$68.11																																																						
25-49	\$64.70																																																						
50-99	\$61.30																																																						
100+	\$58.57																																																						
5	 <table border="1"> <thead> <tr><th colspan="2">PRICE</th></tr> </thead> <tbody> <tr><td>1-24</td><td>\$43.53</td></tr> <tr><td>25-49</td><td>\$41.35</td></tr> <tr><td>50-99</td><td>\$39.18</td></tr> <tr><td>100+</td><td>\$37.44</td></tr> </tbody> </table> <p>SMP Female to SMP Female</p> <p>Max. Freq. 26.5 GHz</p> <p>Model No: PE9777</p>	PRICE		1-24	\$43.53	25-49	\$41.35	50-99	\$39.18	100+	\$37.44	<p>SMP <i>Between Series</i></p> <p>→</p>		 <table border="1"> <thead> <tr><th colspan="2">PRICE</th></tr> </thead> <tbody> <tr><td>1-24</td><td>\$12.24</td></tr> <tr><td>25-49</td><td>\$11.63</td></tr> <tr><td>50-99</td><td>\$11.02</td></tr> <tr><td>100+</td><td>\$10.53</td></tr> </tbody> </table> <p>NEW</p> <p>Push-On SMP Female to Snap-On MMBX Plug</p> <p>VSWR 1.25:1 to 6 GHz</p> <p>Model No: PE91364</p>	PRICE		1-24	\$12.24	25-49	\$11.63	50-99	\$11.02	100+	\$10.53	 <table border="1"> <thead> <tr><th colspan="2">PRICE</th></tr> </thead> <tbody> <tr><td>1-24</td><td>\$27.22</td></tr> <tr><td>25-49</td><td>\$25.86</td></tr> <tr><td>50-99</td><td>\$24.50</td></tr> <tr><td>100+</td><td>\$23.41</td></tr> </tbody> </table> <p>SMP Female to SMP Female</p> <p>Max. Freq. 40 GHz</p> <p>Model No: PE91065</p>	PRICE		1-24	\$27.22	25-49	\$25.86	50-99	\$24.50	100+	\$23.41	<p>SSMA <i>In-Series</i></p> <p>→</p>																			
	PRICE																																																						
1-24	\$43.53																																																						
25-49	\$41.35																																																						
50-99	\$39.18																																																						
100+	\$37.44																																																						
PRICE																																																							
1-24	\$12.24																																																						
25-49	\$11.63																																																						
50-99	\$11.02																																																						
100+	\$10.53																																																						
PRICE																																																							
1-24	\$27.22																																																						
25-49	\$25.86																																																						
50-99	\$24.50																																																						
100+	\$23.41																																																						
6	 <table border="1"> <thead> <tr><th colspan="2">PRICE</th></tr> </thead> <tbody> <tr><td>1-9</td><td>\$112.53</td></tr> <tr><td>10-24</td><td>\$106.90</td></tr> <tr><td>25-49</td><td>\$101.28</td></tr> <tr><td>50+</td><td>\$96.78</td></tr> </tbody> </table> <p>SSMA Male to SSMA Male</p> <p>Model No: PE9357</p>	PRICE		1-9	\$112.53	10-24	\$106.90	25-49	\$101.28	50+	\$96.78	 <table border="1"> <thead> <tr><th colspan="2">PRICE</th></tr> </thead> <tbody> <tr><td>1-24</td><td>\$71.18</td></tr> <tr><td>25-49</td><td>\$67.62</td></tr> <tr><td>50-99</td><td>\$64.06</td></tr> <tr><td>100+</td><td>\$61.21</td></tr> </tbody> </table> <p>SSMA Male to SSMA Female</p> <p>Model No: PE9358</p>	PRICE		1-24	\$71.18	25-49	\$67.62	50-99	\$64.06	100+	\$61.21	 <table border="1"> <thead> <tr><th colspan="2">PRICE</th></tr> </thead> <tbody> <tr><td>1-9</td><td>\$168.39</td></tr> <tr><td>10-24</td><td>\$159.97</td></tr> <tr><td>25-49</td><td>\$151.55</td></tr> <tr><td>50+</td><td>\$144.82</td></tr> </tbody> </table> <p>QD SSMA Male to SSMA Female</p> <p>Model No: PE9685</p>	PRICE		1-9	\$168.39	10-24	\$159.97	25-49	\$151.55	50+	\$144.82	 <table border="1"> <thead> <tr><th colspan="2">PRICE</th></tr> </thead> <tbody> <tr><td>1-24</td><td>\$88.13</td></tr> <tr><td>25-49</td><td>\$83.72</td></tr> <tr><td>50-99</td><td>\$79.32</td></tr> <tr><td>100+</td><td>\$75.79</td></tr> </tbody> </table> <p>SSMA Male to SSMA Female Right Angle</p> <p>VSWR 1.3:1 to 18 GHz</p> <p>Model No: PE9334</p>	PRICE		1-24	\$88.13	25-49	\$83.72	50-99	\$79.32	100+	\$75.79	 <table border="1"> <thead> <tr><th colspan="2">PRICE</th></tr> </thead> <tbody> <tr><td>1-24</td><td>\$62.84</td></tr> <tr><td>25-49</td><td>\$59.70</td></tr> <tr><td>50-99</td><td>\$56.56</td></tr> <tr><td>100+</td><td>\$54.04</td></tr> </tbody> </table> <p>SSMA Female to SSMA Female</p> <p>VSWR 1.3:1 to 25 GHz</p> <p>Model No: PE9192</p>	PRICE		1-24	\$62.84	25-49	\$59.70	50-99	\$56.56	100+	\$54.04
	PRICE																																																						
1-9	\$112.53																																																						
10-24	\$106.90																																																						
25-49	\$101.28																																																						
50+	\$96.78																																																						
PRICE																																																							
1-24	\$71.18																																																						
25-49	\$67.62																																																						
50-99	\$64.06																																																						
100+	\$61.21																																																						
PRICE																																																							
1-9	\$168.39																																																						
10-24	\$159.97																																																						
25-49	\$151.55																																																						
50+	\$144.82																																																						
PRICE																																																							
1-24	\$88.13																																																						
25-49	\$83.72																																																						
50-99	\$79.32																																																						
100+	\$75.79																																																						
PRICE																																																							
1-24	\$62.84																																																						
25-49	\$59.70																																																						
50-99	\$56.56																																																						
100+	\$54.04																																																						
7	 <table border="1"> <thead> <tr><th colspan="2">PRICE</th></tr> </thead> <tbody> <tr><td>1-24</td><td>\$65.35</td></tr> <tr><td>25-49</td><td>\$62.08</td></tr> <tr><td>50-99</td><td>\$58.82</td></tr> <tr><td>100+</td><td>\$56.20</td></tr> </tbody> </table> <p>SSMA Female to SSMA Female Bulkhead-Mounting Hole B01</p> <p>Model No: PE9189</p>	PRICE		1-24	\$65.35	25-49	\$62.08	50-99	\$58.82	100+	\$56.20	<p>SSMA <i>Between Series</i></p> <p>→</p>		 <table border="1"> <thead> <tr><th colspan="2">PRICE</th></tr> </thead> <tbody> <tr><td>1-9</td><td>\$123.51</td></tr> <tr><td>10-24</td><td>\$117.33</td></tr> <tr><td>25-49</td><td>\$111.16</td></tr> <tr><td>50+</td><td>\$106.22</td></tr> </tbody> </table> <p>SSMA Male to BNC Male</p> <p>Model No: PE9213</p>	PRICE		1-9	\$123.51	10-24	\$117.33	25-49	\$111.16	50+	\$106.22	 <table border="1"> <thead> <tr><th colspan="2">PRICE</th></tr> </thead> <tbody> <tr><td>1-24</td><td>\$111.74</td></tr> <tr><td>25-49</td><td>\$106.15</td></tr> <tr><td>50-99</td><td>\$100.57</td></tr> <tr><td>100+</td><td>\$96.10</td></tr> </tbody> </table> <p>SSMA Male to BNC Female</p> <p>Model No: PE91046</p>	PRICE		1-24	\$111.74	25-49	\$106.15	50-99	\$100.57	100+	\$96.10	 <table border="1"> <thead> <tr><th colspan="2">PRICE</th></tr> </thead> <tbody> <tr><td>1-24</td><td>\$96.07</td></tr> <tr><td>25-49</td><td>\$91.27</td></tr> <tr><td>50-99</td><td>\$86.46</td></tr> <tr><td>100+</td><td>\$82.62</td></tr> </tbody> </table> <p>SSMA Male to N Male</p> <p>Max. Freq. 11 GHz</p> <p>Model No: PE9351</p>	PRICE		1-24	\$96.07	25-49	\$91.27	50-99	\$86.46	100+	\$82.62									
	PRICE																																																						
1-24	\$65.35																																																						
25-49	\$62.08																																																						
50-99	\$58.82																																																						
100+	\$56.20																																																						
PRICE																																																							
1-9	\$123.51																																																						
10-24	\$117.33																																																						
25-49	\$111.16																																																						
50+	\$106.22																																																						
PRICE																																																							
1-24	\$111.74																																																						
25-49	\$106.15																																																						
50-99	\$100.57																																																						
100+	\$96.10																																																						
PRICE																																																							
1-24	\$96.07																																																						
25-49	\$91.27																																																						
50-99	\$86.46																																																						
100+	\$82.62																																																						

ADAPTERS

See Adapter Locator on Pages 8-13

See Page 369 for Mounting Holes

Adapters

See Our Website For Current Pricing & Real-Time Stock Availability!

	A	B	C	D	E																																																		
1	 <table border="1"> <thead> <tr> <th colspan="2">PRICE</th> </tr> </thead> <tbody> <tr> <td>1-9</td> <td>\$299.66</td> </tr> <tr> <td>10-24</td> <td>\$284.68</td> </tr> <tr> <td>25-49</td> <td>\$269.69</td> </tr> <tr> <td>50+</td> <td>\$257.71</td> </tr> </tbody> </table> <p>PRECISION SSMA Female to 7mm Sexless</p> <p>Model No: PE9356</p>	PRICE		1-9	\$299.66	10-24	\$284.68	25-49	\$269.69	50+	\$257.71	 <table border="1"> <thead> <tr> <th colspan="2">PRICE</th> </tr> </thead> <tbody> <tr> <td>1-24</td> <td>\$96.14</td> </tr> <tr> <td>25-49</td> <td>\$92.29</td> </tr> <tr> <td>50-99</td> <td>\$89.41</td> </tr> <tr> <td>100+</td> <td>\$87.49</td> </tr> </tbody> </table> <p>SSMA Female to BNC Male</p> <p>Model No: PE9191</p>	PRICE		1-24	\$96.14	25-49	\$92.29	50-99	\$89.41	100+	\$87.49	 <table border="1"> <thead> <tr> <th colspan="2">PRICE</th> </tr> </thead> <tbody> <tr> <td>1-24</td> <td>\$85.67</td> </tr> <tr> <td>25-49</td> <td>\$81.39</td> </tr> <tr> <td>50-99</td> <td>\$77.10</td> </tr> <tr> <td>100+</td> <td>\$73.68</td> </tr> </tbody> </table> <p>SSMA Female to N Male</p> <p>Model No: PE9352</p>	PRICE		1-24	\$85.67	25-49	\$81.39	50-99	\$77.10	100+	\$73.68	 <table border="1"> <thead> <tr> <th colspan="2">PRICE</th> </tr> </thead> <tbody> <tr> <td>1-24</td> <td>\$78.96</td> </tr> <tr> <td>25-49</td> <td>\$75.01</td> </tr> <tr> <td>50-99</td> <td>\$71.06</td> </tr> <tr> <td>100+</td> <td>\$67.91</td> </tr> </tbody> </table> <p>SSMA Female to N Female</p> <p>Model No: PE9354</p>	PRICE		1-24	\$78.96	25-49	\$75.01	50-99	\$71.06	100+	\$67.91	<p>SSMB Between Series</p> <p>→</p>										
PRICE																																																							
1-9	\$299.66																																																						
10-24	\$284.68																																																						
25-49	\$269.69																																																						
50+	\$257.71																																																						
PRICE																																																							
1-24	\$96.14																																																						
25-49	\$92.29																																																						
50-99	\$89.41																																																						
100+	\$87.49																																																						
PRICE																																																							
1-24	\$85.67																																																						
25-49	\$81.39																																																						
50-99	\$77.10																																																						
100+	\$73.68																																																						
PRICE																																																							
1-24	\$78.96																																																						
25-49	\$75.01																																																						
50-99	\$71.06																																																						
100+	\$67.91																																																						
2	 <table border="1"> <thead> <tr> <th colspan="2">PRICE</th> </tr> </thead> <tbody> <tr> <td>1-24</td> <td>\$86.06</td> </tr> <tr> <td>25-49</td> <td>\$81.76</td> </tr> <tr> <td>50-99</td> <td>\$77.45</td> </tr> <tr> <td>100+</td> <td>\$74.01</td> </tr> </tbody> </table> <p>SSMB Plug to BNC Male</p> <p>Model No: PE9393</p>	PRICE		1-24	\$86.06	25-49	\$81.76	50-99	\$77.45	100+	\$74.01	 <table border="1"> <thead> <tr> <th colspan="2">PRICE</th> </tr> </thead> <tbody> <tr> <td>1-24</td> <td>\$108.18</td> </tr> <tr> <td>25-49</td> <td>\$102.77</td> </tr> <tr> <td>50-99</td> <td>\$97.36</td> </tr> <tr> <td>100+</td> <td>\$93.03</td> </tr> </tbody> </table> <p>SSMB Plug to BNC Female</p> <p>Model No: PE9395</p>	PRICE		1-24	\$108.18	25-49	\$102.77	50-99	\$97.36	100+	\$93.03	 <table border="1"> <thead> <tr> <th colspan="2">PRICE</th> </tr> </thead> <tbody> <tr> <td>1-24</td> <td>\$111.34</td> </tr> <tr> <td>25-49</td> <td>\$105.77</td> </tr> <tr> <td>50-99</td> <td>\$100.21</td> </tr> <tr> <td>100+</td> <td>\$95.75</td> </tr> </tbody> </table> <p>SSMB Jack to BNC Male</p> <p>Model No: PE9392</p>	PRICE		1-24	\$111.34	25-49	\$105.77	50-99	\$100.21	100+	\$95.75	 <table border="1"> <thead> <tr> <th colspan="2">PRICE</th> </tr> </thead> <tbody> <tr> <td>1-24</td> <td>\$111.30</td> </tr> <tr> <td>25-49</td> <td>\$105.74</td> </tr> <tr> <td>50-99</td> <td>\$100.17</td> </tr> <tr> <td>100+</td> <td>\$95.72</td> </tr> </tbody> </table> <p>SSMB Jack to BNC Female</p> <p>Model No: PE9394</p>	PRICE		1-24	\$111.30	25-49	\$105.74	50-99	\$100.17	100+	\$95.72	<p>SSMC In-Series</p> <p>→</p>										
PRICE																																																							
1-24	\$86.06																																																						
25-49	\$81.76																																																						
50-99	\$77.45																																																						
100+	\$74.01																																																						
PRICE																																																							
1-24	\$108.18																																																						
25-49	\$102.77																																																						
50-99	\$97.36																																																						
100+	\$93.03																																																						
PRICE																																																							
1-24	\$111.34																																																						
25-49	\$105.77																																																						
50-99	\$100.21																																																						
100+	\$95.75																																																						
PRICE																																																							
1-24	\$111.30																																																						
25-49	\$105.74																																																						
50-99	\$100.17																																																						
100+	\$95.72																																																						
3	 <table border="1"> <thead> <tr> <th colspan="2">PRICE</th> </tr> </thead> <tbody> <tr> <td>1-24</td> <td>\$52.13</td> </tr> <tr> <td>25-49</td> <td>\$50.04</td> </tr> <tr> <td>50-99</td> <td>\$48.48</td> </tr> <tr> <td>100+</td> <td>\$47.44</td> </tr> </tbody> </table> <p>NEW SSMC Plug to SSMC Plug VSWR 1.25:1 to 12 GHz</p> <p>Model No: PE91436</p>	PRICE		1-24	\$52.13	25-49	\$50.04	50-99	\$48.48	100+	\$47.44	 <table border="1"> <thead> <tr> <th colspan="2">PRICE</th> </tr> </thead> <tbody> <tr> <td>1-24</td> <td>\$52.13</td> </tr> <tr> <td>25-49</td> <td>\$49.52</td> </tr> <tr> <td>50-99</td> <td>\$46.92</td> </tr> <tr> <td>100+</td> <td>\$44.83</td> </tr> </tbody> </table> <p>NEW SSMC Plug to SSMC Jack VSWR 1.25:1 to 12 GHz</p> <p>Model No: PE91434</p>	PRICE		1-24	\$52.13	25-49	\$49.52	50-99	\$46.92	100+	\$44.83	 <table border="1"> <thead> <tr> <th colspan="2">PRICE</th> </tr> </thead> <tbody> <tr> <td>1-24</td> <td>\$52.13</td> </tr> <tr> <td>25-49</td> <td>\$49.52</td> </tr> <tr> <td>50-99</td> <td>\$46.92</td> </tr> <tr> <td>100+</td> <td>\$44.83</td> </tr> </tbody> </table> <p>NEW SSMC Jack to SSMC Jack Bulkhead VSWR 1.25:1 to 4 GHz</p> <p>Model No: PE91432</p>	PRICE		1-24	\$52.13	25-49	\$49.52	50-99	\$46.92	100+	\$44.83	<p>TNC In-Series</p> <p>→</p>	 <table border="1"> <thead> <tr> <th colspan="2">PRICE</th> </tr> </thead> <tbody> <tr> <td>1-24</td> <td>\$61.44</td> </tr> <tr> <td>25-49</td> <td>\$58.37</td> </tr> <tr> <td>50-99</td> <td>\$55.30</td> </tr> <tr> <td>100+</td> <td>\$52.84</td> </tr> </tbody> </table> <p>Low PIM TNC Male to TNC Male VSWR 1.25:1 to 6 GHz</p> <p>Model No: PE91172</p>	PRICE		1-24	\$61.44	25-49	\$58.37	50-99	\$55.30	100+	\$52.84										
PRICE																																																							
1-24	\$52.13																																																						
25-49	\$50.04																																																						
50-99	\$48.48																																																						
100+	\$47.44																																																						
PRICE																																																							
1-24	\$52.13																																																						
25-49	\$49.52																																																						
50-99	\$46.92																																																						
100+	\$44.83																																																						
PRICE																																																							
1-24	\$52.13																																																						
25-49	\$49.52																																																						
50-99	\$46.92																																																						
100+	\$44.83																																																						
PRICE																																																							
1-24	\$61.44																																																						
25-49	\$58.37																																																						
50-99	\$55.30																																																						
100+	\$52.84																																																						
4	 <table border="1"> <thead> <tr> <th colspan="2">PRICE</th> </tr> </thead> <tbody> <tr> <td>1-24</td> <td>\$52.91</td> </tr> <tr> <td>25-49</td> <td>\$50.26</td> </tr> <tr> <td>50-99</td> <td>\$47.62</td> </tr> <tr> <td>100+</td> <td>\$45.50</td> </tr> </tbody> </table> <p>TNC Male to TNC Male VSWR 1.2:1 to 6 GHz</p> <p>Model No: PE91202</p>	PRICE		1-24	\$52.91	25-49	\$50.26	50-99	\$47.62	100+	\$45.50	 <table border="1"> <thead> <tr> <th colspan="2">PRICE</th> </tr> </thead> <tbody> <tr> <td>1-24</td> <td>\$51.97</td> </tr> <tr> <td>25-49</td> <td>\$49.37</td> </tr> <tr> <td>50-99</td> <td>\$46.77</td> </tr> <tr> <td>100+</td> <td>\$44.69</td> </tr> </tbody> </table> <p>TNC Male to TNC Male VSWR 1.3:1 to 6 GHz</p> <p>Model No: PE91239</p>	PRICE		1-24	\$51.97	25-49	\$49.37	50-99	\$46.77	100+	\$44.69	 <table border="1"> <thead> <tr> <th colspan="2">PRICE</th> </tr> </thead> <tbody> <tr> <td>1-24</td> <td>\$35.15</td> </tr> <tr> <td>25-49</td> <td>\$33.39</td> </tr> <tr> <td>50-99</td> <td>\$31.64</td> </tr> <tr> <td>100+</td> <td>\$30.23</td> </tr> </tbody> </table> <p>TNC Male to TNC Male VSWR 1.3:1 to 1,000 MHz</p> <p>Model No: PE9091</p>	PRICE		1-24	\$35.15	25-49	\$33.39	50-99	\$31.64	100+	\$30.23	 <table border="1"> <thead> <tr> <th colspan="2">PRICE</th> </tr> </thead> <tbody> <tr> <td>1-9</td> <td>\$159.25</td> </tr> <tr> <td>10-24</td> <td>\$151.29</td> </tr> <tr> <td>25-49</td> <td>\$143.33</td> </tr> <tr> <td>50+</td> <td>\$136.96</td> </tr> </tbody> </table> <p>TNC Male to TNC Male VSWR 1.25:1 to 18 GHz</p> <p>Model No: PE9445</p>	PRICE		1-9	\$159.25	10-24	\$151.29	25-49	\$143.33	50+	\$136.96	 <table border="1"> <thead> <tr> <th colspan="2">PRICE</th> </tr> </thead> <tbody> <tr> <td>1-24</td> <td>\$93.02</td> </tr> <tr> <td>25-49</td> <td>\$88.37</td> </tr> <tr> <td>50-99</td> <td>\$83.72</td> </tr> <tr> <td>100+</td> <td>\$80.00</td> </tr> </tbody> </table> <p>TNC Male to TNC Male Right Angle</p> <p>Model No: PE9560</p>	PRICE		1-24	\$93.02	25-49	\$88.37	50-99	\$83.72	100+	\$80.00
PRICE																																																							
1-24	\$52.91																																																						
25-49	\$50.26																																																						
50-99	\$47.62																																																						
100+	\$45.50																																																						
PRICE																																																							
1-24	\$51.97																																																						
25-49	\$49.37																																																						
50-99	\$46.77																																																						
100+	\$44.69																																																						
PRICE																																																							
1-24	\$35.15																																																						
25-49	\$33.39																																																						
50-99	\$31.64																																																						
100+	\$30.23																																																						
PRICE																																																							
1-9	\$159.25																																																						
10-24	\$151.29																																																						
25-49	\$143.33																																																						
50+	\$136.96																																																						
PRICE																																																							
1-24	\$93.02																																																						
25-49	\$88.37																																																						
50-99	\$83.72																																																						
100+	\$80.00																																																						
5	 <table border="1"> <thead> <tr> <th colspan="2">PRICE</th> </tr> </thead> <tbody> <tr> <td>1-24</td> <td>\$52.91</td> </tr> <tr> <td>25-49</td> <td>\$50.26</td> </tr> <tr> <td>50-99</td> <td>\$47.62</td> </tr> <tr> <td>100+</td> <td>\$45.50</td> </tr> </tbody> </table> <p>TNC Male to TNC Female VSWR 1.2:1 to 6 GHz</p> <p>Model No: PE91203</p>	PRICE		1-24	\$52.91	25-49	\$50.26	50-99	\$47.62	100+	\$45.50	 <table border="1"> <thead> <tr> <th colspan="2">PRICE</th> </tr> </thead> <tbody> <tr> <td>1-24</td> <td>\$51.66</td> </tr> <tr> <td>25-49</td> <td>\$49.08</td> </tr> <tr> <td>50-99</td> <td>\$46.49</td> </tr> <tr> <td>100+</td> <td>\$44.43</td> </tr> </tbody> </table> <p>TNC Male to TNC Female VSWR 1.3:1 to 6 GHz</p> <p>Model No: PE91240</p>	PRICE		1-24	\$51.66	25-49	\$49.08	50-99	\$46.49	100+	\$44.43	 <table border="1"> <thead> <tr> <th colspan="2">PRICE</th> </tr> </thead> <tbody> <tr> <td>1-24</td> <td>\$69.69</td> </tr> <tr> <td>25-49</td> <td>\$64.81</td> </tr> <tr> <td>50-99</td> <td>\$59.93</td> </tr> <tr> <td>100+</td> <td>\$55.75</td> </tr> </tbody> </table> <p>PRECISION TNC Male to TNC Female VSWR 1.15:1 to 18 GHz</p> <p>Model No: PE91505</p>	PRICE		1-24	\$69.69	25-49	\$64.81	50-99	\$59.93	100+	\$55.75	 <table border="1"> <thead> <tr> <th colspan="2">PRICE</th> </tr> </thead> <tbody> <tr> <td>1-24</td> <td>\$58.54</td> </tr> <tr> <td>25-49</td> <td>\$55.61</td> </tr> <tr> <td>50-99</td> <td>\$52.69</td> </tr> <tr> <td>100+</td> <td>\$50.34</td> </tr> </tbody> </table> <p>Low PIM TNC Male to TNC Female VSWR 1.25:1 to 6 GHz</p> <p>Model No: PE91173</p>	PRICE		1-24	\$58.54	25-49	\$55.61	50-99	\$52.69	100+	\$50.34	 <table border="1"> <thead> <tr> <th colspan="2">PRICE</th> </tr> </thead> <tbody> <tr> <td>1-24</td> <td>\$24.23</td> </tr> <tr> <td>25-49</td> <td>\$23.02</td> </tr> <tr> <td>50-99</td> <td>\$21.81</td> </tr> <tr> <td>100+</td> <td>\$20.84</td> </tr> </tbody> </table> <p>TNC Male to TNC Female VSWR 1.5:1 to 11 GHz</p> <p>Model No: PE9270</p>	PRICE		1-24	\$24.23	25-49	\$23.02	50-99	\$21.81	100+	\$20.84
PRICE																																																							
1-24	\$52.91																																																						
25-49	\$50.26																																																						
50-99	\$47.62																																																						
100+	\$45.50																																																						
PRICE																																																							
1-24	\$51.66																																																						
25-49	\$49.08																																																						
50-99	\$46.49																																																						
100+	\$44.43																																																						
PRICE																																																							
1-24	\$69.69																																																						
25-49	\$64.81																																																						
50-99	\$59.93																																																						
100+	\$55.75																																																						
PRICE																																																							
1-24	\$58.54																																																						
25-49	\$55.61																																																						
50-99	\$52.69																																																						
100+	\$50.34																																																						
PRICE																																																							
1-24	\$24.23																																																						
25-49	\$23.02																																																						
50-99	\$21.81																																																						
100+	\$20.84																																																						
6	 <table border="1"> <thead> <tr> <th colspan="2">PRICE</th> </tr> </thead> <tbody> <tr> <td>1-24</td> <td>\$132.70</td> </tr> <tr> <td>25-49</td> <td>\$123.41</td> </tr> <tr> <td>50-99</td> <td>\$114.12</td> </tr> <tr> <td>100+</td> <td>\$106.16</td> </tr> </tbody> </table> <p>PRECISION TNC Male to TNC Female VSWR 1.15:1 to 18 GHz</p> <p>Model No: PE9443</p>	PRICE		1-24	\$132.70	25-49	\$123.41	50-99	\$114.12	100+	\$106.16	 <table border="1"> <thead> <tr> <th colspan="2">PRICE</th> </tr> </thead> <tbody> <tr> <td>1-9</td> <td>\$188.44</td> </tr> <tr> <td>10-24</td> <td>\$179.02</td> </tr> <tr> <td>25-49</td> <td>\$169.60</td> </tr> <tr> <td>50+</td> <td>\$162.06</td> </tr> </tbody> </table> <p>QD TNC Male to TNC Female</p> <p>Model No: PE9561</p>	PRICE		1-9	\$188.44	10-24	\$179.02	25-49	\$169.60	50+	\$162.06	 <table border="1"> <thead> <tr> <th colspan="2">PRICE</th> </tr> </thead> <tbody> <tr> <td>1-24</td> <td>\$33.06</td> </tr> <tr> <td>25-49</td> <td>\$31.41</td> </tr> <tr> <td>50-99</td> <td>\$29.75</td> </tr> <tr> <td>100+</td> <td>\$28.43</td> </tr> </tbody> </table> <p>TNC Male to TNC Female Right Angle Max. Freq. 11 GHz</p> <p>Model No: PE9100</p>	PRICE		1-24	\$33.06	25-49	\$31.41	50-99	\$29.75	100+	\$28.43	 <table border="1"> <thead> <tr> <th colspan="2">PRICE</th> </tr> </thead> <tbody> <tr> <td>1-24</td> <td>\$86.05</td> </tr> <tr> <td>25-49</td> <td>\$81.75</td> </tr> <tr> <td>50-99</td> <td>\$77.45</td> </tr> <tr> <td>100+</td> <td>\$74.00</td> </tr> </tbody> </table> <p>TNC Male to TNC Female Tee</p> <p>Model No: PE9290</p>	PRICE		1-24	\$86.05	25-49	\$81.75	50-99	\$77.45	100+	\$74.00	 <table border="1"> <thead> <tr> <th colspan="2">PRICE</th> </tr> </thead> <tbody> <tr> <td>1-24</td> <td>\$28.32</td> </tr> <tr> <td>25-49</td> <td>\$26.90</td> </tr> <tr> <td>50-99</td> <td>\$25.49</td> </tr> <tr> <td>100+</td> <td>\$24.36</td> </tr> </tbody> </table> <p>TNC Female to TNC Male Tee Max. Freq. 11 GHz</p> <p>Model No: PE9195</p>	PRICE		1-24	\$28.32	25-49	\$26.90	50-99	\$25.49	100+	\$24.36
PRICE																																																							
1-24	\$132.70																																																						
25-49	\$123.41																																																						
50-99	\$114.12																																																						
100+	\$106.16																																																						
PRICE																																																							
1-9	\$188.44																																																						
10-24	\$179.02																																																						
25-49	\$169.60																																																						
50+	\$162.06																																																						
PRICE																																																							
1-24	\$33.06																																																						
25-49	\$31.41																																																						
50-99	\$29.75																																																						
100+	\$28.43																																																						
PRICE																																																							
1-24	\$86.05																																																						
25-49	\$81.75																																																						
50-99	\$77.45																																																						
100+	\$74.00																																																						
PRICE																																																							
1-24	\$28.32																																																						
25-49	\$26.90																																																						
50-99	\$25.49																																																						
100+	\$24.36																																																						
7	 <table border="1"> <thead> <tr> <th colspan="2">PRICE</th> </tr> </thead> <tbody> <tr> <td>1-24</td> <td>\$52.91</td> </tr> <tr> <td>25-49</td> <td>\$50.26</td> </tr> <tr> <td>50-99</td> <td>\$47.62</td> </tr> <tr> <td>100+</td> <td>\$45.50</td> </tr> </tbody> </table> <p>TNC Female to TNC Female VSWR 1.2:1 to 6 GHz</p> <p>Model No: PE91204</p>	PRICE		1-24	\$52.91	25-49	\$50.26	50-99	\$47.62	100+	\$45.50	 <table border="1"> <thead> <tr> <th colspan="2">PRICE</th> </tr> </thead> <tbody> <tr> <td>1-24</td> <td>\$46.90</td> </tr> <tr> <td>25-49</td> <td>\$44.56</td> </tr> <tr> <td>50-99</td> <td>\$42.21</td> </tr> <tr> <td>100+</td> <td>\$40.33</td> </tr> </tbody> </table> <p>TNC Female to TNC Female VSWR 1.3:1 to 6 GHz</p> <p>Model No: PE91241</p>	PRICE		1-24	\$46.90	25-49	\$44.56	50-99	\$42.21	100+	\$40.33	 <table border="1"> <thead> <tr> <th colspan="2">PRICE</th> </tr> </thead> <tbody> <tr> <td>1-24</td> <td>\$14.92</td> </tr> <tr> <td>25-49</td> <td>\$14.17</td> </tr> <tr> <td>50-99</td> <td>\$13.43</td> </tr> <tr> <td>100+</td> <td>\$12.83</td> </tr> </tbody> </table> <p>TNC Female to TNC Female VSWR 1.3:1 to 5 GHz</p> <p>Model No: PE9099</p>	PRICE		1-24	\$14.92	25-49	\$14.17	50-99	\$13.43	100+	\$12.83	 <table border="1"> <thead> <tr> <th colspan="2">PRICE</th> </tr> </thead> <tbody> <tr> <td>1-24</td> <td>\$53.66</td> </tr> <tr> <td>25-49</td> <td>\$50.98</td> </tr> <tr> <td>50-99</td> <td>\$48.29</td> </tr> <tr> <td>100+</td> <td>\$46.15</td> </tr> </tbody> </table> <p>Low PIM TNC Female to TNC Female VSWR 1.25:1 to 6 GHz</p> <p>Model No: PE91174</p>	PRICE		1-24	\$53.66	25-49	\$50.98	50-99	\$48.29	100+	\$46.15	 <table border="1"> <thead> <tr> <th colspan="2">PRICE</th> </tr> </thead> <tbody> <tr> <td>1-9</td> <td>\$124.73</td> </tr> <tr> <td>10-24</td> <td>\$118.49</td> </tr> <tr> <td>25-49</td> <td>\$112.26</td> </tr> <tr> <td>50+</td> <td>\$107.27</td> </tr> </tbody> </table> <p>PRECISION TNC Female to TNC Female VSWR 1.15:1 to 18 GHz</p> <p>Model No: PE9444</p>	PRICE		1-9	\$124.73	10-24	\$118.49	25-49	\$112.26	50+	\$107.27
PRICE																																																							
1-24	\$52.91																																																						
25-49	\$50.26																																																						
50-99	\$47.62																																																						
100+	\$45.50																																																						
PRICE																																																							
1-24	\$46.90																																																						
25-49	\$44.56																																																						
50-99	\$42.21																																																						
100+	\$40.33																																																						
PRICE																																																							
1-24	\$14.92																																																						
25-49	\$14.17																																																						
50-99	\$13.43																																																						
100+	\$12.83																																																						
PRICE																																																							
1-24	\$53.66																																																						
25-49	\$50.98																																																						
50-99	\$48.29																																																						
100+	\$46.15																																																						
PRICE																																																							
1-9	\$124.73																																																						
10-24	\$118.49																																																						
25-49	\$112.26																																																						
50+	\$107.27																																																						

ADAPTERS

See Adapter Locator on Pages 8-13

See Page 369 for Mounting Holes

	A	B	C	D	E																																													
1	 <table border="1"> <thead> <tr><th>PRICE</th></tr> </thead> <tbody> <tr><td>1-24</td><td>\$35.68</td></tr> <tr><td>25-49</td><td>\$33.90</td></tr> <tr><td>50-99</td><td>\$32.11</td></tr> <tr><td>NEW 100+</td><td>\$30.68</td></tr> </tbody> </table> <p>TNC Female to TNC Female Tee</p> <p>Model No: PE91381</p>	PRICE	1-24	\$35.68	25-49	\$33.90	50-99	\$32.11	NEW 100+	\$30.68	 <table border="1"> <thead> <tr><th>PRICE</th></tr> </thead> <tbody> <tr><td>1-24</td><td>\$27.35</td></tr> <tr><td>25-49</td><td>\$25.98</td></tr> <tr><td>50-99</td><td>\$24.62</td></tr> <tr><td>100+</td><td>\$23.52</td></tr> </tbody> </table> <p>TNC Female to TNC Female Bulkhead VSWR 1.3:1 to 6 GHz</p> <p>Model No: PE9154</p>	PRICE	1-24	\$27.35	25-49	\$25.98	50-99	\$24.62	100+	\$23.52	 <table border="1"> <thead> <tr><th>PRICE</th></tr> </thead> <tbody> <tr><td>1-24</td><td>\$35.26</td></tr> <tr><td>25-49</td><td>\$33.50</td></tr> <tr><td>50-99</td><td>\$31.73</td></tr> <tr><td>100+</td><td>\$30.32</td></tr> </tbody> </table> <p>TNC Female to TNC Female 4 Hole Flange VSWR 1.3:1 to 11 GHz</p> <p>Model No: PE9288</p>	PRICE	1-24	\$35.26	25-49	\$33.50	50-99	\$31.73	100+	\$30.32	 <table border="1"> <thead> <tr><th>PRICE</th></tr> </thead> <tbody> <tr><td>1-24</td><td>\$52.51</td></tr> <tr><td>25-49</td><td>\$49.88</td></tr> <tr><td>50-99</td><td>\$47.26</td></tr> <tr><td>100+</td><td>\$45.16</td></tr> </tbody> </table> <p>TNC Female to TNC Female Bulkhead VSWR 1.2:1 to 6 GHz</p> <p>Model No: PE91205</p>	PRICE	1-24	\$52.51	25-49	\$49.88	50-99	\$47.26	100+	\$45.16	 <table border="1"> <thead> <tr><th>PRICE</th></tr> </thead> <tbody> <tr><td>1-24</td><td>\$64.16</td></tr> <tr><td>25-49</td><td>\$60.95</td></tr> <tr><td>50-99</td><td>\$57.74</td></tr> <tr><td>100+</td><td>\$55.18</td></tr> </tbody> </table> <p>TNC Female to TNC Female Bulkhead VSWR 1.3:1 to 6 GHz</p> <p>Model No: PE91242</p>	PRICE	1-24	\$64.16	25-49	\$60.95	50-99	\$57.74	100+	\$55.18
PRICE																																																		
1-24	\$35.68																																																	
25-49	\$33.90																																																	
50-99	\$32.11																																																	
NEW 100+	\$30.68																																																	
PRICE																																																		
1-24	\$27.35																																																	
25-49	\$25.98																																																	
50-99	\$24.62																																																	
100+	\$23.52																																																	
PRICE																																																		
1-24	\$35.26																																																	
25-49	\$33.50																																																	
50-99	\$31.73																																																	
100+	\$30.32																																																	
PRICE																																																		
1-24	\$52.51																																																	
25-49	\$49.88																																																	
50-99	\$47.26																																																	
100+	\$45.16																																																	
PRICE																																																		
1-24	\$64.16																																																	
25-49	\$60.95																																																	
50-99	\$57.74																																																	
100+	\$55.18																																																	
2	 <table border="1"> <thead> <tr><th>PRICE</th></tr> </thead> <tbody> <tr><td>1-24</td><td>\$30.68</td></tr> <tr><td>25-49</td><td>\$29.15</td></tr> <tr><td>50-99</td><td>\$27.61</td></tr> <tr><td>100+</td><td>\$26.38</td></tr> </tbody> </table> <p>TNC Female to TNC Female Bulkhead Max. Freq. 11 GHz</p> <p>Model No: PE9287</p>	PRICE	1-24	\$30.68	25-49	\$29.15	50-99	\$27.61	100+	\$26.38	<p>Reverse Polarity TNC In-Series</p> 		 <table border="1"> <thead> <tr><th>PRICE</th></tr> </thead> <tbody> <tr><td>1-24</td><td>\$41.39</td></tr> <tr><td>25-49</td><td>\$39.32</td></tr> <tr><td>50-99</td><td>\$37.25</td></tr> <tr><td>100+</td><td>\$35.60</td></tr> </tbody> </table> <p>TNC Male to Rev. Pol. TNC Female</p> <p>Model No: PE9532</p>	PRICE	1-24	\$41.39	25-49	\$39.32	50-99	\$37.25	100+	\$35.60	 <table border="1"> <thead> <tr><th>PRICE</th></tr> </thead> <tbody> <tr><td>1-24</td><td>\$40.00</td></tr> <tr><td>25-49</td><td>\$38.00</td></tr> <tr><td>50-99</td><td>\$36.00</td></tr> <tr><td>100+</td><td>\$34.40</td></tr> </tbody> </table> <p>TNC Female to Rev. Pol. TNC Male VSWR 1.32:1 to 6 GHz</p> <p>Model No: PE9531</p>	PRICE	1-24	\$40.00	25-49	\$38.00	50-99	\$36.00	100+	\$34.40	 <table border="1"> <thead> <tr><th>PRICE</th></tr> </thead> <tbody> <tr><td>1-24</td><td>\$33.78</td></tr> <tr><td>25-49</td><td>\$32.09</td></tr> <tr><td>50-99</td><td>\$30.40</td></tr> <tr><td>100+</td><td>\$29.05</td></tr> </tbody> </table> <p>Rev. Pol. TNC Male to Rev. Pol. TNC Female VSWR 1.25:1 to 6 GHz</p> <p>Model No: PE9918</p>	PRICE	1-24	\$33.78	25-49	\$32.09	50-99	\$30.40	100+	\$29.05								
PRICE																																																		
1-24	\$30.68																																																	
25-49	\$29.15																																																	
50-99	\$27.61																																																	
100+	\$26.38																																																	
PRICE																																																		
1-24	\$41.39																																																	
25-49	\$39.32																																																	
50-99	\$37.25																																																	
100+	\$35.60																																																	
PRICE																																																		
1-24	\$40.00																																																	
25-49	\$38.00																																																	
50-99	\$36.00																																																	
100+	\$34.40																																																	
PRICE																																																		
1-24	\$33.78																																																	
25-49	\$32.09																																																	
50-99	\$30.40																																																	
100+	\$29.05																																																	
3	<p>TNC Between Series</p> 		 <table border="1"> <thead> <tr><th>PRICE</th></tr> </thead> <tbody> <tr><td>1-4</td><td>\$700.87</td></tr> <tr><td>5-9</td><td>\$665.83</td></tr> <tr><td>10-24</td><td>\$630.78</td></tr> <tr><td>PRECISION 25+</td><td>\$602.75</td></tr> </tbody> </table> <p>TNC Male to 7mm Sexless VSWR 1.15:1 to 18 GHz</p> <p>Model No: PE9219</p>	PRICE	1-4	\$700.87	5-9	\$665.83	10-24	\$630.78	PRECISION 25+	\$602.75	 <table border="1"> <thead> <tr><th>PRICE</th></tr> </thead> <tbody> <tr><td>1-9</td><td>\$253.83</td></tr> <tr><td>10-24</td><td>\$241.14</td></tr> <tr><td>25-49</td><td>\$228.45</td></tr> <tr><td>50+</td><td>\$218.29</td></tr> </tbody> </table> <p>TNC Male to 7/16 DIN Female VSWR 1.35:1 to 7.5 GHz</p> <p>Model No: PE9638</p>	PRICE	1-9	\$253.83	10-24	\$241.14	25-49	\$228.45	50+	\$218.29	 <table border="1"> <thead> <tr><th>PRICE</th></tr> </thead> <tbody> <tr><td>1-24</td><td>\$19.63</td></tr> <tr><td>25-49</td><td>\$18.65</td></tr> <tr><td>50-99</td><td>\$17.67</td></tr> <tr><td>100+</td><td>\$16.88</td></tr> </tbody> </table> <p>TNC Male to BNC Female VSWR 1.5:1 to 2 GHz</p> <p>Model No: PE9088</p>	PRICE	1-24	\$19.63	25-49	\$18.65	50-99	\$17.67	100+	\$16.88	 <table border="1"> <thead> <tr><th>PRICE</th></tr> </thead> <tbody> <tr><td>1-24</td><td>\$67.33</td></tr> <tr><td>25-49</td><td>\$63.96</td></tr> <tr><td>50-99</td><td>\$60.60</td></tr> <tr><td>100+</td><td>\$57.90</td></tr> </tbody> </table> <p>TNC Male to BNC Female Right Angle</p> <p>Model No: PE9783</p>	PRICE	1-24	\$67.33	25-49	\$63.96	50-99	\$60.60	100+	\$57.90								
PRICE																																																		
1-4	\$700.87																																																	
5-9	\$665.83																																																	
10-24	\$630.78																																																	
PRECISION 25+	\$602.75																																																	
PRICE																																																		
1-9	\$253.83																																																	
10-24	\$241.14																																																	
25-49	\$228.45																																																	
50+	\$218.29																																																	
PRICE																																																		
1-24	\$19.63																																																	
25-49	\$18.65																																																	
50-99	\$17.67																																																	
100+	\$16.88																																																	
PRICE																																																		
1-24	\$67.33																																																	
25-49	\$63.96																																																	
50-99	\$60.60																																																	
100+	\$57.90																																																	
4	 <table border="1"> <thead> <tr><th>PRICE</th></tr> </thead> <tbody> <tr><td>1-24</td><td>\$115.97</td></tr> <tr><td>25-49</td><td>\$110.17</td></tr> <tr><td>50-99</td><td>\$104.37</td></tr> <tr><td>100+</td><td>\$99.73</td></tr> </tbody> </table> <p>TNC Male to C Female</p> <p>Model No: PE9562</p>	PRICE	1-24	\$115.97	25-49	\$110.17	50-99	\$104.37	100+	\$99.73	 <table border="1"> <thead> <tr><th>PRICE</th></tr> </thead> <tbody> <tr><td>1-24</td><td>\$20.43</td></tr> <tr><td>25-49</td><td>\$19.41</td></tr> <tr><td>50-99</td><td>\$18.39</td></tr> <tr><td>100+</td><td>\$17.57</td></tr> </tbody> </table> <p>TNC Male to FME Plug</p> <p>Model No: PE9699</p>	PRICE	1-24	\$20.43	25-49	\$19.41	50-99	\$18.39	100+	\$17.57	 <table border="1"> <thead> <tr><th>PRICE</th></tr> </thead> <tbody> <tr><td>1-24</td><td>\$11.83</td></tr> <tr><td>25-49</td><td>\$11.24</td></tr> <tr><td>50-99</td><td>\$10.65</td></tr> <tr><td>100+</td><td>\$10.17</td></tr> </tbody> </table> <p>TNC Male to FME Plug Right Angle</p> <p>Model No: PE9700</p>	PRICE	1-24	\$11.83	25-49	\$11.24	50-99	\$10.65	100+	\$10.17	 <table border="1"> <thead> <tr><th>PRICE</th></tr> </thead> <tbody> <tr><td>1-24</td><td>\$17.58</td></tr> <tr><td>25-49</td><td>\$16.70</td></tr> <tr><td>50-99</td><td>\$15.82</td></tr> <tr><td>100+</td><td>\$15.12</td></tr> </tbody> </table> <p>TNC Male to FME Jack</p> <p>Model No: PE9713</p>	PRICE	1-24	\$17.58	25-49	\$16.70	50-99	\$15.82	100+	\$15.12	 <table border="1"> <thead> <tr><th>PRICE</th></tr> </thead> <tbody> <tr><td>1-24</td><td>\$87.50</td></tr> <tr><td>25-49</td><td>\$83.13</td></tr> <tr><td>50-99</td><td>\$78.75</td></tr> <tr><td>100+</td><td>\$75.25</td></tr> </tbody> </table> <p>TNC Male to HN Male</p> <p>Model No: PE9563</p>	PRICE	1-24	\$87.50	25-49	\$83.13	50-99	\$78.75	100+	\$75.25
PRICE																																																		
1-24	\$115.97																																																	
25-49	\$110.17																																																	
50-99	\$104.37																																																	
100+	\$99.73																																																	
PRICE																																																		
1-24	\$20.43																																																	
25-49	\$19.41																																																	
50-99	\$18.39																																																	
100+	\$17.57																																																	
PRICE																																																		
1-24	\$11.83																																																	
25-49	\$11.24																																																	
50-99	\$10.65																																																	
100+	\$10.17																																																	
PRICE																																																		
1-24	\$17.58																																																	
25-49	\$16.70																																																	
50-99	\$15.82																																																	
100+	\$15.12																																																	
PRICE																																																		
1-24	\$87.50																																																	
25-49	\$83.13																																																	
50-99	\$78.75																																																	
100+	\$75.25																																																	
5	 <table border="1"> <thead> <tr><th>PRICE</th></tr> </thead> <tbody> <tr><td>1-24</td><td>\$71.38</td></tr> <tr><td>25-49</td><td>\$67.81</td></tr> <tr><td>50-99</td><td>\$64.24</td></tr> <tr><td>100+</td><td>\$61.39</td></tr> </tbody> </table> <p>TNC Male to MCX Plug</p> <p>Model No: PE9543</p>	PRICE	1-24	\$71.38	25-49	\$67.81	50-99	\$64.24	100+	\$61.39	 <table border="1"> <thead> <tr><th>PRICE</th></tr> </thead> <tbody> <tr><td>1-24</td><td>\$77.53</td></tr> <tr><td>25-49</td><td>\$73.65</td></tr> <tr><td>50-99</td><td>\$69.78</td></tr> <tr><td>100+</td><td>\$66.68</td></tr> </tbody> </table> <p>TNC Male to MCX Jack</p> <p>Model No: PE9542</p>	PRICE	1-24	\$77.53	25-49	\$73.65	50-99	\$69.78	100+	\$66.68	 <table border="1"> <thead> <tr><th>PRICE</th></tr> </thead> <tbody> <tr><td>1-24</td><td>\$22.00</td></tr> <tr><td>25-49</td><td>\$20.90</td></tr> <tr><td>50-99</td><td>\$19.80</td></tr> <tr><td>100+</td><td>\$18.92</td></tr> </tbody> </table> <p>TNC Male to Mini UHF Female</p> <p>Model No: PE9345</p>	PRICE	1-24	\$22.00	25-49	\$20.90	50-99	\$19.80	100+	\$18.92	 <table border="1"> <thead> <tr><th>PRICE</th></tr> </thead> <tbody> <tr><td>1-24</td><td>\$64.89</td></tr> <tr><td>25-49</td><td>\$61.65</td></tr> <tr><td>50-99</td><td>\$58.40</td></tr> <tr><td>100+</td><td>\$55.81</td></tr> </tbody> </table> <p>TNC Male to SMC Jack</p> <p>Model No: PE9226</p>	PRICE	1-24	\$64.89	25-49	\$61.65	50-99	\$58.40	100+	\$55.81	 <table border="1"> <thead> <tr><th>PRICE</th></tr> </thead> <tbody> <tr><td>1-24</td><td>\$27.46</td></tr> <tr><td>25-49</td><td>\$26.09</td></tr> <tr><td>50-99</td><td>\$24.71</td></tr> <tr><td>100+</td><td>\$23.62</td></tr> </tbody> </table> <p>TNC Male to UHF Female Max. Freq. 300 MHz</p> <p>Model No: PE9291</p>	PRICE	1-24	\$27.46	25-49	\$26.09	50-99	\$24.71	100+	\$23.62
PRICE																																																		
1-24	\$71.38																																																	
25-49	\$67.81																																																	
50-99	\$64.24																																																	
100+	\$61.39																																																	
PRICE																																																		
1-24	\$77.53																																																	
25-49	\$73.65																																																	
50-99	\$69.78																																																	
100+	\$66.68																																																	
PRICE																																																		
1-24	\$22.00																																																	
25-49	\$20.90																																																	
50-99	\$19.80																																																	
100+	\$18.92																																																	
PRICE																																																		
1-24	\$64.89																																																	
25-49	\$61.65																																																	
50-99	\$58.40																																																	
100+	\$55.81																																																	
PRICE																																																		
1-24	\$27.46																																																	
25-49	\$26.09																																																	
50-99	\$24.71																																																	
100+	\$23.62																																																	
6	 <table border="1"> <thead> <tr><th>PRICE</th></tr> </thead> <tbody> <tr><td>1-9</td><td>\$578.53</td></tr> <tr><td>10-24</td><td>\$549.60</td></tr> <tr><td>25-49</td><td>\$520.68</td></tr> <tr><td>PRECISION 50+</td><td>\$497.54</td></tr> </tbody> </table> <p>TNC Female to 7mm Sexless VSWR 1.15:1 to 18 GHz</p> <p>Model No: PE9218</p>	PRICE	1-9	\$578.53	10-24	\$549.60	25-49	\$520.68	PRECISION 50+	\$497.54	 <table border="1"> <thead> <tr><th>PRICE</th></tr> </thead> <tbody> <tr><td>1-9</td><td>\$269.07</td></tr> <tr><td>10-24</td><td>\$255.62</td></tr> <tr><td>25-49</td><td>\$242.16</td></tr> <tr><td>50+</td><td>\$231.40</td></tr> </tbody> </table> <p>TNC Female to 7/16 DIN Female Max. Freq. 7.5 GHz</p> <p>Model No: PE91392</p>	PRICE	1-9	\$269.07	10-24	\$255.62	25-49	\$242.16	50+	\$231.40	 <table border="1"> <thead> <tr><th>PRICE</th></tr> </thead> <tbody> <tr><td>1-24</td><td>\$28.96</td></tr> <tr><td>25-49</td><td>\$27.51</td></tr> <tr><td>50-99</td><td>\$26.06</td></tr> <tr><td>100+</td><td>\$24.91</td></tr> </tbody> </table> <p>TNC Female to BNC Male VSWR 1.3:1 to 4 GHz</p> <p>Model No: PE9098</p>	PRICE	1-24	\$28.96	25-49	\$27.51	50-99	\$26.06	100+	\$24.91	 <table border="1"> <thead> <tr><th>PRICE</th></tr> </thead> <tbody> <tr><td>1-24</td><td>\$36.22</td></tr> <tr><td>25-49</td><td>\$34.41</td></tr> <tr><td>50-99</td><td>\$32.60</td></tr> <tr><td>100+</td><td>\$31.15</td></tr> </tbody> </table> <p>TNC Female to BNC Female VSWR 1.3:1 to 4 GHz</p> <p>Model No: PE9097</p>	PRICE	1-24	\$36.22	25-49	\$34.41	50-99	\$32.60	100+	\$31.15	 <table border="1"> <thead> <tr><th>PRICE</th></tr> </thead> <tbody> <tr><td>1-9</td><td>\$134.92</td></tr> <tr><td>10-24</td><td>\$128.17</td></tr> <tr><td>25-49</td><td>\$121.43</td></tr> <tr><td>50+</td><td>\$116.03</td></tr> </tbody> </table> <p>TNC Female to C Male</p> <p>Model No: PE9564</p>	PRICE	1-9	\$134.92	10-24	\$128.17	25-49	\$121.43	50+	\$116.03
PRICE																																																		
1-9	\$578.53																																																	
10-24	\$549.60																																																	
25-49	\$520.68																																																	
PRECISION 50+	\$497.54																																																	
PRICE																																																		
1-9	\$269.07																																																	
10-24	\$255.62																																																	
25-49	\$242.16																																																	
50+	\$231.40																																																	
PRICE																																																		
1-24	\$28.96																																																	
25-49	\$27.51																																																	
50-99	\$26.06																																																	
100+	\$24.91																																																	
PRICE																																																		
1-24	\$36.22																																																	
25-49	\$34.41																																																	
50-99	\$32.60																																																	
100+	\$31.15																																																	
PRICE																																																		
1-9	\$134.92																																																	
10-24	\$128.17																																																	
25-49	\$121.43																																																	
50+	\$116.03																																																	
7	 <table border="1"> <thead> <tr><th>PRICE</th></tr> </thead> <tbody> <tr><td>1-24</td><td>\$5.28</td></tr> <tr><td>25-49</td><td>\$5.02</td></tr> <tr><td>50-99</td><td>\$4.75</td></tr> <tr><td>100+</td><td>\$4.54</td></tr> </tbody> </table> <p>TNC Female to FME Jack</p> <p>Model No: PE9714</p>	PRICE	1-24	\$5.28	25-49	\$5.02	50-99	\$4.75	100+	\$4.54	 <table border="1"> <thead> <tr><th>PRICE</th></tr> </thead> <tbody> <tr><td>1-24</td><td>\$76.40</td></tr> <tr><td>25-49</td><td>\$72.58</td></tr> <tr><td>50-99</td><td>\$68.76</td></tr> <tr><td>100+</td><td>\$65.70</td></tr> </tbody> </table> <p>TNC Female to MCX Plug</p> <p>Model No: PE9545</p>	PRICE	1-24	\$76.40	25-49	\$72.58	50-99	\$68.76	100+	\$65.70	 <table border="1"> <thead> <tr><th>PRICE</th></tr> </thead> <tbody> <tr><td>1-24</td><td>\$80.84</td></tr> <tr><td>25-49</td><td>\$76.80</td></tr> <tr><td>50-99</td><td>\$72.76</td></tr> <tr><td>100+</td><td>\$69.52</td></tr> </tbody> </table> <p>TNC Female to MCX Jack</p> <p>Model No: PE9544</p>	PRICE	1-24	\$80.84	25-49	\$76.80	50-99	\$72.76	100+	\$69.52	 <table border="1"> <thead> <tr><th>PRICE</th></tr> </thead> <tbody> <tr><td>1-24</td><td>\$93.75</td></tr> <tr><td>25-49</td><td>\$89.06</td></tr> <tr><td>50-99</td><td>\$84.38</td></tr> <tr><td>100+</td><td>\$80.63</td></tr> </tbody> </table> <p>TNC Female to MCX Jack Bulkhead-Mounting Hole B04</p> <p>Model No: PE9521</p>	PRICE	1-24	\$93.75	25-49	\$89.06	50-99	\$84.38	100+	\$80.63	 <table border="1"> <thead> <tr><th>PRICE</th></tr> </thead> <tbody> <tr><td>1-24</td><td>\$19.96</td></tr> <tr><td>25-49</td><td>\$18.96</td></tr> <tr><td>50-99</td><td>\$17.96</td></tr> <tr><td>100+</td><td>\$17.17</td></tr> </tbody> </table> <p>TNC Female to Mini UHF Male Max. Freq. 2.5 GHz</p> <p>Model No: PE9346</p>	PRICE	1-24	\$19.96	25-49	\$18.96	50-99	\$17.96	100+	\$17.17
PRICE																																																		
1-24	\$5.28																																																	
25-49	\$5.02																																																	
50-99	\$4.75																																																	
100+	\$4.54																																																	
PRICE																																																		
1-24	\$76.40																																																	
25-49	\$72.58																																																	
50-99	\$68.76																																																	
100+	\$65.70																																																	
PRICE																																																		
1-24	\$80.84																																																	
25-49	\$76.80																																																	
50-99	\$72.76																																																	
100+	\$69.52																																																	
PRICE																																																		
1-24	\$93.75																																																	
25-49	\$89.06																																																	
50-99	\$84.38																																																	
100+	\$80.63																																																	
PRICE																																																		
1-24	\$19.96																																																	
25-49	\$18.96																																																	
50-99	\$17.96																																																	
100+	\$17.17																																																	

ADAPTERS

See Adapter Locator on Pages 8-13

See Page 369 for Mounting Holes

Adapters

See Our Website For Current Pricing & Real-Time Stock Availability!

	A	B	C	D	E																																																		
1	 <table border="1"> <thead> <tr> <th colspan="2">PRICE</th> </tr> </thead> <tbody> <tr> <td>1-9</td> <td>\$212.18</td> </tr> <tr> <td>10-24</td> <td>\$201.57</td> </tr> <tr> <td>25-49</td> <td>\$190.96</td> </tr> <tr> <td>50+</td> <td>\$182.47</td> </tr> </tbody> </table> <p>TNC Female to Limited Detent SMP Male Bulkhead VSWR 1.3:1 to 8 GHz</p> <p>Model No: PE91073</p>	PRICE		1-9	\$212.18	10-24	\$201.57	25-49	\$190.96	50+	\$182.47	 <table border="1"> <thead> <tr> <th colspan="2">PRICE</th> </tr> </thead> <tbody> <tr> <td>1-24</td> <td>\$35.95</td> </tr> <tr> <td>25-49</td> <td>\$34.15</td> </tr> <tr> <td>50-99</td> <td>\$32.36</td> </tr> <tr> <td>100+</td> <td>\$30.92</td> </tr> </tbody> </table> <p>TNC Female to UHF Male VSWR 1.3:1 to 300 MHz</p> <p>Model No: PE9372</p>	PRICE		1-24	\$35.95	25-49	\$34.15	50-99	\$32.36	100+	\$30.92	<p>Reverse Polarity TNC Between Series</p> 		 <table border="1"> <thead> <tr> <th colspan="2">PRICE</th> </tr> </thead> <tbody> <tr> <td>1-24</td> <td>\$36.21</td> </tr> <tr> <td>25-49</td> <td>\$34.40</td> </tr> <tr> <td>50-99</td> <td>\$32.59</td> </tr> <tr> <td>100+</td> <td>\$31.14</td> </tr> </tbody> </table> <p>Rev. Pol. TNC Female to BNC Male Max. Freq. 4 GHz</p> <p>Model No: PE91087</p>	PRICE		1-24	\$36.21	25-49	\$34.40	50-99	\$32.59	100+	\$31.14	<p>UHF In-Series</p> 																			
PRICE																																																							
1-9	\$212.18																																																						
10-24	\$201.57																																																						
25-49	\$190.96																																																						
50+	\$182.47																																																						
PRICE																																																							
1-24	\$35.95																																																						
25-49	\$34.15																																																						
50-99	\$32.36																																																						
100+	\$30.92																																																						
PRICE																																																							
1-24	\$36.21																																																						
25-49	\$34.40																																																						
50-99	\$32.59																																																						
100+	\$31.14																																																						
2	 <table border="1"> <thead> <tr> <th colspan="2">PRICE</th> </tr> </thead> <tbody> <tr> <td>1-24</td> <td>\$20.01</td> </tr> <tr> <td>25-49</td> <td>\$19.01</td> </tr> <tr> <td>50-99</td> <td>\$18.01</td> </tr> <tr> <td>NEW 100+</td> <td>\$17.21</td> </tr> </tbody> </table> <p>UHF Male to UHF Male VSWR 1.3:1 to 300 MHz</p> <p>Model No: PE91487</p>	PRICE		1-24	\$20.01	25-49	\$19.01	50-99	\$18.01	NEW 100+	\$17.21	 <table border="1"> <thead> <tr> <th colspan="2">PRICE</th> </tr> </thead> <tbody> <tr> <td>1-24</td> <td>\$30.87</td> </tr> <tr> <td>25-49</td> <td>\$29.33</td> </tr> <tr> <td>50-99</td> <td>\$27.78</td> </tr> <tr> <td>100+</td> <td>\$26.55</td> </tr> </tbody> </table> <p>UHF Male to UHF Female Right Angle Max. Freq. 300 MHz</p> <p>Model No: PE9209</p>	PRICE		1-24	\$30.87	25-49	\$29.33	50-99	\$27.78	100+	\$26.55	 <table border="1"> <thead> <tr> <th colspan="2">PRICE</th> </tr> </thead> <tbody> <tr> <td>1-24</td> <td>\$25.72</td> </tr> <tr> <td>25-49</td> <td>\$24.43</td> </tr> <tr> <td>50-99</td> <td>\$23.15</td> </tr> <tr> <td>100+</td> <td>\$22.12</td> </tr> </tbody> </table> <p>UHF Female to UHF Male Tee</p> <p>Model No: PE9095</p>	PRICE		1-24	\$25.72	25-49	\$24.43	50-99	\$23.15	100+	\$22.12	 <table border="1"> <thead> <tr> <th colspan="2">PRICE</th> </tr> </thead> <tbody> <tr> <td>1-24</td> <td>\$20.72</td> </tr> <tr> <td>25-49</td> <td>\$19.68</td> </tr> <tr> <td>50-99</td> <td>\$18.65</td> </tr> <tr> <td>100+</td> <td>\$17.82</td> </tr> </tbody> </table> <p>UHF Female to UHF Female VSWR 1.3:1 to 300 MHz</p> <p>Model No: PE9094</p>	PRICE		1-24	\$20.72	25-49	\$19.68	50-99	\$18.65	100+	\$17.82	 <table border="1"> <thead> <tr> <th colspan="2">PRICE</th> </tr> </thead> <tbody> <tr> <td>1-24</td> <td>\$47.31</td> </tr> <tr> <td>25-49</td> <td>\$44.94</td> </tr> <tr> <td>50-99</td> <td>\$42.58</td> </tr> <tr> <td>100+</td> <td>\$40.69</td> </tr> </tbody> </table> <p>UHF Female to UHF Female Bulkhead-Mounting Hole F03 Max. Freq. 300 MHz</p> <p>Model No: PE9114</p>	PRICE		1-24	\$47.31	25-49	\$44.94	50-99	\$42.58	100+	\$40.69
PRICE																																																							
1-24	\$20.01																																																						
25-49	\$19.01																																																						
50-99	\$18.01																																																						
NEW 100+	\$17.21																																																						
PRICE																																																							
1-24	\$30.87																																																						
25-49	\$29.33																																																						
50-99	\$27.78																																																						
100+	\$26.55																																																						
PRICE																																																							
1-24	\$25.72																																																						
25-49	\$24.43																																																						
50-99	\$23.15																																																						
100+	\$22.12																																																						
PRICE																																																							
1-24	\$20.72																																																						
25-49	\$19.68																																																						
50-99	\$18.65																																																						
100+	\$17.82																																																						
PRICE																																																							
1-24	\$47.31																																																						
25-49	\$44.94																																																						
50-99	\$42.58																																																						
100+	\$40.69																																																						
3	<p>UHF Between Series</p> 		 <table border="1"> <thead> <tr> <th colspan="2">PRICE</th> </tr> </thead> <tbody> <tr> <td>1-24</td> <td>\$27.86</td> </tr> <tr> <td>25-49</td> <td>\$26.47</td> </tr> <tr> <td>50-99</td> <td>\$25.07</td> </tr> <tr> <td>100+</td> <td>\$23.96</td> </tr> </tbody> </table> <p>UHF Male to BNC Male</p> <p>Model No: PE9201</p>	PRICE		1-24	\$27.86	25-49	\$26.47	50-99	\$25.07	100+	\$23.96	 <table border="1"> <thead> <tr> <th colspan="2">PRICE</th> </tr> </thead> <tbody> <tr> <td>1-24</td> <td>\$13.53</td> </tr> <tr> <td>25-49</td> <td>\$12.85</td> </tr> <tr> <td>50-99</td> <td>\$12.18</td> </tr> <tr> <td>100+</td> <td>\$11.64</td> </tr> </tbody> </table> <p>UHF Male to BNC Female VSWR 1.3:1 to 300 MHz</p> <p>Model No: PE91328</p>	PRICE		1-24	\$13.53	25-49	\$12.85	50-99	\$12.18	100+	\$11.64	 <table border="1"> <thead> <tr> <th colspan="2">PRICE</th> </tr> </thead> <tbody> <tr> <td>1-24</td> <td>\$36.50</td> </tr> <tr> <td>25-49</td> <td>\$34.68</td> </tr> <tr> <td>50-99</td> <td>\$32.85</td> </tr> <tr> <td>100+</td> <td>\$31.39</td> </tr> </tbody> </table> <p>UHF Male to 75 Ohm F Female</p> <p>Model No: PE9165</p>	PRICE		1-24	\$36.50	25-49	\$34.68	50-99	\$32.85	100+	\$31.39	 <table border="1"> <thead> <tr> <th colspan="2">PRICE</th> </tr> </thead> <tbody> <tr> <td>1-24</td> <td>\$19.46</td> </tr> <tr> <td>25-49</td> <td>\$18.49</td> </tr> <tr> <td>50-99</td> <td>\$17.51</td> </tr> <tr> <td>100+</td> <td>\$16.74</td> </tr> </tbody> </table> <p>UHF Male to FME Plug</p> <p>Model No: PE9701</p>	PRICE		1-24	\$19.46	25-49	\$18.49	50-99	\$17.51	100+	\$16.74									
PRICE																																																							
1-24	\$27.86																																																						
25-49	\$26.47																																																						
50-99	\$25.07																																																						
100+	\$23.96																																																						
PRICE																																																							
1-24	\$13.53																																																						
25-49	\$12.85																																																						
50-99	\$12.18																																																						
100+	\$11.64																																																						
PRICE																																																							
1-24	\$36.50																																																						
25-49	\$34.68																																																						
50-99	\$32.85																																																						
100+	\$31.39																																																						
PRICE																																																							
1-24	\$19.46																																																						
25-49	\$18.49																																																						
50-99	\$17.51																																																						
100+	\$16.74																																																						
4	 <table border="1"> <thead> <tr> <th colspan="2">PRICE</th> </tr> </thead> <tbody> <tr> <td>1-24</td> <td>\$20.72</td> </tr> <tr> <td>25-49</td> <td>\$19.68</td> </tr> <tr> <td>50-99</td> <td>\$18.65</td> </tr> <tr> <td>100+</td> <td>\$17.82</td> </tr> </tbody> </table> <p>UHF Male to Mini UHF Female</p> <p>Model No: PE9348</p>	PRICE		1-24	\$20.72	25-49	\$19.68	50-99	\$18.65	100+	\$17.82	 <table border="1"> <thead> <tr> <th colspan="2">PRICE</th> </tr> </thead> <tbody> <tr> <td>1-24</td> <td>\$16.56</td> </tr> <tr> <td>25-49</td> <td>\$15.73</td> </tr> <tr> <td>50-99</td> <td>\$14.90</td> </tr> <tr> <td>100+</td> <td>\$14.24</td> </tr> </tbody> </table> <p>UHF Female to BNC Male VSWR 1.3:1 to 300 MHz</p> <p>Model No: PE91329</p>	PRICE		1-24	\$16.56	25-49	\$15.73	50-99	\$14.90	100+	\$14.24	 <table border="1"> <thead> <tr> <th colspan="2">PRICE</th> </tr> </thead> <tbody> <tr> <td>1-24</td> <td>\$25.72</td> </tr> <tr> <td>25-49</td> <td>\$24.43</td> </tr> <tr> <td>50-99</td> <td>\$23.15</td> </tr> <tr> <td>100+</td> <td>\$22.12</td> </tr> </tbody> </table> <p>UHF Female to BNC Female</p> <p>Model No: PE9421</p>	PRICE		1-24	\$25.72	25-49	\$24.43	50-99	\$23.15	100+	\$22.12	 <table border="1"> <thead> <tr> <th colspan="2">PRICE</th> </tr> </thead> <tbody> <tr> <td>1-24</td> <td>\$32.99</td> </tr> <tr> <td>25-49</td> <td>\$31.34</td> </tr> <tr> <td>50-99</td> <td>\$29.69</td> </tr> <tr> <td>100+</td> <td>\$28.37</td> </tr> </tbody> </table> <p>UHF Female to 75 Ohm F Female</p> <p>Model No: PE9167</p>	PRICE		1-24	\$32.99	25-49	\$31.34	50-99	\$29.69	100+	\$28.37	 <table border="1"> <thead> <tr> <th colspan="2">PRICE</th> </tr> </thead> <tbody> <tr> <td>1-24</td> <td>\$14.83</td> </tr> <tr> <td>25-49</td> <td>\$14.09</td> </tr> <tr> <td>50-99</td> <td>\$13.35</td> </tr> <tr> <td>NEW 100+</td> <td>\$12.75</td> </tr> </tbody> </table> <p>UHF Female to Mini UHF Male VSWR 1.3:1 to 300 MHz</p> <p>Model No: PE91447</p>	PRICE		1-24	\$14.83	25-49	\$14.09	50-99	\$13.35	NEW 100+	\$12.75
PRICE																																																							
1-24	\$20.72																																																						
25-49	\$19.68																																																						
50-99	\$18.65																																																						
100+	\$17.82																																																						
PRICE																																																							
1-24	\$16.56																																																						
25-49	\$15.73																																																						
50-99	\$14.90																																																						
100+	\$14.24																																																						
PRICE																																																							
1-24	\$25.72																																																						
25-49	\$24.43																																																						
50-99	\$23.15																																																						
100+	\$22.12																																																						
PRICE																																																							
1-24	\$32.99																																																						
25-49	\$31.34																																																						
50-99	\$29.69																																																						
100+	\$28.37																																																						
PRICE																																																							
1-24	\$14.83																																																						
25-49	\$14.09																																																						
50-99	\$13.35																																																						
NEW 100+	\$12.75																																																						
5	<p>2.92mm NMD Between Series</p> 		<p>75 Ohm BNC In-Series</p> 		 <table border="1"> <thead> <tr> <th colspan="2">PRICE</th> </tr> </thead> <tbody> <tr> <td>1-24</td> <td>\$28.28</td> </tr> <tr> <td>25-49</td> <td>\$26.87</td> </tr> <tr> <td>50-99</td> <td>\$25.45</td> </tr> <tr> <td>100+</td> <td>\$24.32</td> </tr> </tbody> </table> <p>75 Ohm BNC Male to 75 Ohm BNC Male VSWR 1.5:1 to 300 MHz</p> <p>Model No: PE9364</p>	PRICE		1-24	\$28.28	25-49	\$26.87	50-99	\$25.45	100+	\$24.32	 <table border="1"> <thead> <tr> <th colspan="2">PRICE</th> </tr> </thead> <tbody> <tr> <td>1-24</td> <td>\$40.26</td> </tr> <tr> <td>25-49</td> <td>\$38.25</td> </tr> <tr> <td>50-99</td> <td>\$36.23</td> </tr> <tr> <td>100+</td> <td>\$34.62</td> </tr> </tbody> </table> <p>75 Ohm BNC Male to 75 Ohm BNC Female Right Angle Max. Freq. 4 GHz</p> <p>Model No: PE9361</p>	PRICE		1-24	\$40.26	25-49	\$38.25	50-99	\$36.23	100+	\$34.62																													
PRICE																																																							
1-24	\$28.28																																																						
25-49	\$26.87																																																						
50-99	\$25.45																																																						
100+	\$24.32																																																						
PRICE																																																							
1-24	\$40.26																																																						
25-49	\$38.25																																																						
50-99	\$36.23																																																						
100+	\$34.62																																																						
6	 <table border="1"> <thead> <tr> <th colspan="2">PRICE</th> </tr> </thead> <tbody> <tr> <td>1-24</td> <td>\$42.65</td> </tr> <tr> <td>25-49</td> <td>\$40.52</td> </tr> <tr> <td>50-99</td> <td>\$38.39</td> </tr> <tr> <td>100+</td> <td>\$36.68</td> </tr> </tbody> </table> <p>75 Ohm BNC Female to 75 Ohm BNC Male Tee Max. Freq. 100 MHz</p> <p>Model No: PE9365</p>	PRICE		1-24	\$42.65	25-49	\$40.52	50-99	\$38.39	100+	\$36.68	 <table border="1"> <thead> <tr> <th colspan="2">PRICE</th> </tr> </thead> <tbody> <tr> <td>1-24</td> <td>\$28.39</td> </tr> <tr> <td>25-49</td> <td>\$26.97</td> </tr> <tr> <td>50-99</td> <td>\$25.55</td> </tr> <tr> <td>100+</td> <td>\$24.42</td> </tr> </tbody> </table> <p>75 Ohm BNC Female to 75 Ohm BNC Female VSWR 1.3:1 to 1,000 MHz</p> <p>Model No: PE9362</p>	PRICE		1-24	\$28.39	25-49	\$26.97	50-99	\$25.55	100+	\$24.42	 <table border="1"> <thead> <tr> <th colspan="2">PRICE</th> </tr> </thead> <tbody> <tr> <td>1-24</td> <td>\$39.28</td> </tr> <tr> <td>25-49</td> <td>\$37.32</td> </tr> <tr> <td>50-99</td> <td>\$35.35</td> </tr> <tr> <td>100+</td> <td>\$33.78</td> </tr> </tbody> </table> <p>75 Ohm BNC Female to 75 Ohm BNC Female Bulkhead VSWR 1.3:1 to 1,000 MHz</p> <p>Model No: PE9363</p>	PRICE		1-24	\$39.28	25-49	\$37.32	50-99	\$35.35	100+	\$33.78	 <table border="1"> <thead> <tr> <th colspan="2">PRICE</th> </tr> </thead> <tbody> <tr> <td>1-24</td> <td>\$43.19</td> </tr> <tr> <td>25-49</td> <td>\$41.03</td> </tr> <tr> <td>50-99</td> <td>\$38.87</td> </tr> <tr> <td>100+</td> <td>\$37.14</td> </tr> </tbody> </table> <p>75 Ohm BNC Female to 75 Ohm BNC Female 4 Hole Flange-Mounting Hole A03 Max. Freq. 1,000 MHz</p> <p>Model No: PE9367</p>	PRICE		1-24	\$43.19	25-49	\$41.03	50-99	\$38.87	100+	\$37.14	<p>75 Ohm BNC Between Series</p> 										
PRICE																																																							
1-24	\$42.65																																																						
25-49	\$40.52																																																						
50-99	\$38.39																																																						
100+	\$36.68																																																						
PRICE																																																							
1-24	\$28.39																																																						
25-49	\$26.97																																																						
50-99	\$25.55																																																						
100+	\$24.42																																																						
PRICE																																																							
1-24	\$39.28																																																						
25-49	\$37.32																																																						
50-99	\$35.35																																																						
100+	\$33.78																																																						
PRICE																																																							
1-24	\$43.19																																																						
25-49	\$41.03																																																						
50-99	\$38.87																																																						
100+	\$37.14																																																						
7	 <table border="1"> <thead> <tr> <th colspan="2">PRICE</th> </tr> </thead> <tbody> <tr> <td>1-24</td> <td>\$24.82</td> </tr> <tr> <td>25-49</td> <td>\$23.58</td> </tr> <tr> <td>50-99</td> <td>\$22.34</td> </tr> <tr> <td>100+</td> <td>\$21.35</td> </tr> </tbody> </table> <p>75 Ohm BNC Female to 75 Ohm F Female Bulkhead VSWR 1.3:1 to 1,000 MHz</p> <p>Model No: PE91324</p>	PRICE		1-24	\$24.82	25-49	\$23.58	50-99	\$22.34	100+	\$21.35	<p>75 Ohm F In-Series</p> 		 <table border="1"> <thead> <tr> <th colspan="2">PRICE</th> </tr> </thead> <tbody> <tr> <td>1-24</td> <td>\$40.71</td> </tr> <tr> <td>25-49</td> <td>\$38.67</td> </tr> <tr> <td>50-99</td> <td>\$36.64</td> </tr> <tr> <td>PRECISION NEW 100+</td> <td>\$35.01</td> </tr> </tbody> </table> <p>75 Ohm F Male to 75 Ohm F Male VSWR 1.17:1 to 3 GHz</p> <p>Model No: PE91348</p>	PRICE		1-24	\$40.71	25-49	\$38.67	50-99	\$36.64	PRECISION NEW 100+	\$35.01	 <table border="1"> <thead> <tr> <th colspan="2">PRICE</th> </tr> </thead> <tbody> <tr> <td>1-24</td> <td>\$104.05</td> </tr> <tr> <td>25-49</td> <td>\$98.85</td> </tr> <tr> <td>50-99</td> <td>\$93.65</td> </tr> <tr> <td>100+</td> <td>\$89.48</td> </tr> </tbody> </table> <p>75 Ohm F Male to 75 Ohm F Male VSWR 1.3:1 to 3 GHz</p> <p>Model No: PE9760</p>	PRICE		1-24	\$104.05	25-49	\$98.85	50-99	\$93.65	100+	\$89.48	 <table border="1"> <thead> <tr> <th colspan="2">PRICE</th> </tr> </thead> <tbody> <tr> <td>1-24</td> <td>\$8.98</td> </tr> <tr> <td>25-49</td> <td>\$8.53</td> </tr> <tr> <td>50-99</td> <td>\$8.08</td> </tr> <tr> <td>100+</td> <td>\$7.72</td> </tr> </tbody> </table> <p>75 Ohm Push-On F Male to 75 Ohm F Female VSWR 1.5:1 to 1,000 MHz</p> <p>Model No: PE9160</p>	PRICE		1-24	\$8.98	25-49	\$8.53	50-99	\$8.08	100+	\$7.72									
PRICE																																																							
1-24	\$24.82																																																						
25-49	\$23.58																																																						
50-99	\$22.34																																																						
100+	\$21.35																																																						
PRICE																																																							
1-24	\$40.71																																																						
25-49	\$38.67																																																						
50-99	\$36.64																																																						
PRECISION NEW 100+	\$35.01																																																						
PRICE																																																							
1-24	\$104.05																																																						
25-49	\$98.85																																																						
50-99	\$93.65																																																						
100+	\$89.48																																																						
PRICE																																																							
1-24	\$8.98																																																						
25-49	\$8.53																																																						
50-99	\$8.08																																																						
100+	\$7.72																																																						

ADAPTERS

See Adapter Locator on Pages 8-13

See Page 369 for Mounting Holes

Adapters

See Our Website For Current Pricing & Real-Time Stock Availability!

	A	B	C	D	E																																													
1	 <table border="1"> <thead> <tr><th>PRICE</th></tr> </thead> <tbody> <tr><td>1-24</td><td>\$104.05</td></tr> <tr><td>25-49</td><td>\$98.85</td></tr> <tr><td>50-99</td><td>\$93.65</td></tr> <tr><td>100+</td><td>\$89.48</td></tr> </tbody> </table> <p>75 Ohm F Male to 75 Ohm F Female VSWR 1.3:1 to 3 GHz Model No: PE9759</p>	PRICE	1-24	\$104.05	25-49	\$98.85	50-99	\$93.65	100+	\$89.48	 <table border="1"> <thead> <tr><th>PRICE</th></tr> </thead> <tbody> <tr><td>1-24</td><td>\$10.66</td></tr> <tr><td>25-49</td><td>\$10.13</td></tr> <tr><td>50-99</td><td>\$9.59</td></tr> <tr><td>100+</td><td>\$9.17</td></tr> </tbody> </table> <p>75 Ohm F Male to 75 Ohm F Female Right Angle Max. Freq. 1,000 MHz Model No: PE9166</p>	PRICE	1-24	\$10.66	25-49	\$10.13	50-99	\$9.59	100+	\$9.17	 <table border="1"> <thead> <tr><th>PRICE</th></tr> </thead> <tbody> <tr><td>1-24</td><td>\$25.43</td></tr> <tr><td>25-49</td><td>\$24.16</td></tr> <tr><td>50-99</td><td>\$22.89</td></tr> <tr><td>100+</td><td>\$21.87</td></tr> </tbody> </table> <p>75 Ohm F Female to 75 Ohm F Female VSWR 1.28:1 to 3 GHz Model No: PE91349</p>	PRICE	1-24	\$25.43	25-49	\$24.16	50-99	\$22.89	100+	\$21.87	 <table border="1"> <thead> <tr><th>PRICE</th></tr> </thead> <tbody> <tr><td>1-24</td><td>\$2.86</td></tr> <tr><td>25-49</td><td>\$2.72</td></tr> <tr><td>50-99</td><td>\$2.57</td></tr> <tr><td>100+</td><td>\$2.46</td></tr> </tbody> </table> <p>75 Ohm F Female to 75 Ohm F Female VSWR 1.35:1 to 500 MHz Model No: PE9164</p>	PRICE	1-24	\$2.86	25-49	\$2.72	50-99	\$2.57	100+	\$2.46	 <table border="1"> <thead> <tr><th>PRICE</th></tr> </thead> <tbody> <tr><td>1-24</td><td>\$8.31</td></tr> <tr><td>25-49</td><td>\$7.89</td></tr> <tr><td>50-99</td><td>\$7.48</td></tr> <tr><td>100+</td><td>\$7.15</td></tr> </tbody> </table> <p>75 Ohm F Female to 75 Ohm F Female Bulkhead-Mounting Hole B04 VSWR 1.3:1 to 250 MHz Model No: PE9734</p>	PRICE	1-24	\$8.31	25-49	\$7.89	50-99	\$7.48	100+	\$7.15
PRICE																																																		
1-24	\$104.05																																																	
25-49	\$98.85																																																	
50-99	\$93.65																																																	
100+	\$89.48																																																	
PRICE																																																		
1-24	\$10.66																																																	
25-49	\$10.13																																																	
50-99	\$9.59																																																	
100+	\$9.17																																																	
PRICE																																																		
1-24	\$25.43																																																	
25-49	\$24.16																																																	
50-99	\$22.89																																																	
100+	\$21.87																																																	
PRICE																																																		
1-24	\$2.86																																																	
25-49	\$2.72																																																	
50-99	\$2.57																																																	
100+	\$2.46																																																	
PRICE																																																		
1-24	\$8.31																																																	
25-49	\$7.89																																																	
50-99	\$7.48																																																	
100+	\$7.15																																																	
2	75 Ohm F Between Series 																																																	
3	 <table border="1"> <thead> <tr><th>PRICE</th></tr> </thead> <tbody> <tr><td>1-9</td><td>\$146.84</td></tr> <tr><td>10-24</td><td>\$139.50</td></tr> <tr><td>25-49</td><td>\$132.16</td></tr> <tr><td>50+</td><td>\$126.28</td></tr> </tbody> </table> <p>75 Ohm F Female to 75 Ohm BNC Male VSWR 1.3:1 to 3 GHz Model No: PE9741</p>	PRICE	1-9	\$146.84	10-24	\$139.50	25-49	\$132.16	50+	\$126.28	 <table border="1"> <thead> <tr><th>PRICE</th></tr> </thead> <tbody> <tr><td>1-9</td><td>\$150.98</td></tr> <tr><td>10-24</td><td>\$143.43</td></tr> <tr><td>25-49</td><td>\$135.88</td></tr> <tr><td>50+</td><td>\$129.84</td></tr> </tbody> </table> <p>75 Ohm F Female to 75 Ohm BNC Female VSWR 1.3:1 to 3 GHz Model No: PE9744</p>	PRICE	1-9	\$150.98	10-24	\$143.43	25-49	\$135.88	50+	\$129.84	 <table border="1"> <thead> <tr><th>PRICE</th></tr> </thead> <tbody> <tr><td>1-24</td><td>\$18.49</td></tr> <tr><td>25-49</td><td>\$17.57</td></tr> <tr><td>50-99</td><td>\$16.64</td></tr> <tr><td>100+</td><td>\$15.90</td></tr> </tbody> </table> <p>75 Ohm F Female to 75 Ohm PAL Jack VSWR 1.3:1 to 3 GHz Model No: PE9743</p>	PRICE	1-24	\$18.49	25-49	\$17.57	50-99	\$16.64	100+	\$15.90	 <table border="1"> <thead> <tr><th>PRICE</th></tr> </thead> <tbody> <tr><td>1-24</td><td>\$18.49</td></tr> <tr><td>25-49</td><td>\$17.57</td></tr> <tr><td>50-99</td><td>\$16.64</td></tr> <tr><td>100+</td><td>\$15.90</td></tr> </tbody> </table> <p>75 Ohm F Female to 75 Ohm PAL Plug Model No: PE9633</p>	PRICE	1-24	\$18.49	25-49	\$17.57	50-99	\$16.64	100+	\$15.90	 <table border="1"> <thead> <tr><th>PRICE</th></tr> </thead> <tbody> <tr><td>1-24</td><td>\$18.49</td></tr> <tr><td>25-49</td><td>\$17.57</td></tr> <tr><td>50-99</td><td>\$16.64</td></tr> <tr><td>100+</td><td>\$15.90</td></tr> </tbody> </table> <p>75 Ohm F Female to 75 Ohm PAL Jack Model No: PE9632</p>	PRICE	1-24	\$18.49	25-49	\$17.57	50-99	\$16.64	100+	\$15.90
PRICE																																																		
1-9	\$146.84																																																	
10-24	\$139.50																																																	
25-49	\$132.16																																																	
50+	\$126.28																																																	
PRICE																																																		
1-9	\$150.98																																																	
10-24	\$143.43																																																	
25-49	\$135.88																																																	
50+	\$129.84																																																	
PRICE																																																		
1-24	\$18.49																																																	
25-49	\$17.57																																																	
50-99	\$16.64																																																	
100+	\$15.90																																																	
PRICE																																																		
1-24	\$18.49																																																	
25-49	\$17.57																																																	
50-99	\$16.64																																																	
100+	\$15.90																																																	
PRICE																																																		
1-24	\$18.49																																																	
25-49	\$17.57																																																	
50-99	\$16.64																																																	
100+	\$15.90																																																	
4	 <table border="1"> <thead> <tr><th>PRICE</th></tr> </thead> <tbody> <tr><td>1-24</td><td>\$37.13</td></tr> <tr><td>25-49</td><td>\$35.27</td></tr> <tr><td>50-99</td><td>\$33.42</td></tr> <tr><td>100+</td><td>\$31.93</td></tr> </tbody> </table> <p>75 Ohm Mini SMB Plug to 75 Ohm Mini SMB Plug Model No: PE9609</p>	PRICE	1-24	\$37.13	25-49	\$35.27	50-99	\$33.42	100+	\$31.93	 <table border="1"> <thead> <tr><th>PRICE</th></tr> </thead> <tbody> <tr><td>1-24</td><td>\$53.27</td></tr> <tr><td>25-49</td><td>\$50.61</td></tr> <tr><td>50-99</td><td>\$47.94</td></tr> <tr><td>100+</td><td>\$45.81</td></tr> </tbody> </table> <p>75 Ohm Mini SMB Plug to 75 Ohm Mini SMB Jack Model No: PE9610</p>	PRICE	1-24	\$53.27	25-49	\$50.61	50-99	\$47.94	100+	\$45.81	 <table border="1"> <thead> <tr><th>PRICE</th></tr> </thead> <tbody> <tr><td>1-24</td><td>\$37.13</td></tr> <tr><td>25-49</td><td>\$35.27</td></tr> <tr><td>50-99</td><td>\$33.42</td></tr> <tr><td>100+</td><td>\$31.93</td></tr> </tbody> </table> <p>75 Ohm Mini SMB Jack to 75 Ohm Mini SMB Jack Model No: PE9608</p>	PRICE	1-24	\$37.13	25-49	\$35.27	50-99	\$33.42	100+	\$31.93	 <table border="1"> <thead> <tr><th>PRICE</th></tr> </thead> <tbody> <tr><td>1-24</td><td>\$48.86</td></tr> <tr><td>25-49</td><td>\$46.42</td></tr> <tr><td>50-99</td><td>\$43.97</td></tr> <tr><td>100+</td><td>\$42.02</td></tr> </tbody> </table> <p>75 Ohm Mini SMB Jack to 75 Ohm Mini SMB Jack Bulkhead Model No: PE9611</p>	PRICE	1-24	\$48.86	25-49	\$46.42	50-99	\$43.97	100+	\$42.02	<div style="background-color: #333; color: white; text-align: center; padding: 10px;"> 75 Ohm Mini SMB In-Series  </div>									
PRICE																																																		
1-24	\$37.13																																																	
25-49	\$35.27																																																	
50-99	\$33.42																																																	
100+	\$31.93																																																	
PRICE																																																		
1-24	\$53.27																																																	
25-49	\$50.61																																																	
50-99	\$47.94																																																	
100+	\$45.81																																																	
PRICE																																																		
1-24	\$37.13																																																	
25-49	\$35.27																																																	
50-99	\$33.42																																																	
100+	\$31.93																																																	
PRICE																																																		
1-24	\$48.86																																																	
25-49	\$46.42																																																	
50-99	\$43.97																																																	
100+	\$42.02																																																	
5	 <table border="1"> <thead> <tr><th>PRICE</th></tr> </thead> <tbody> <tr><td>1-24</td><td>\$77.08</td></tr> <tr><td>25-49</td><td>\$73.23</td></tr> <tr><td>50-99</td><td>\$69.37</td></tr> <tr><td>100+</td><td>\$66.29</td></tr> </tbody> </table> <p>75 Ohm Mini SMB Plug to 75 Ohm BNC Male Model No: PE9616</p>	PRICE	1-24	\$77.08	25-49	\$73.23	50-99	\$69.37	100+	\$66.29	 <table border="1"> <thead> <tr><th>PRICE</th></tr> </thead> <tbody> <tr><td>1-24</td><td>\$64.16</td></tr> <tr><td>25-49</td><td>\$60.95</td></tr> <tr><td>50-99</td><td>\$57.74</td></tr> <tr><td>100+</td><td>\$55.18</td></tr> </tbody> </table> <p>75 Ohm Mini SMB Plug to 75 Ohm BNC Female Model No: PE9617</p>	PRICE	1-24	\$64.16	25-49	\$60.95	50-99	\$57.74	100+	\$55.18	 <table border="1"> <thead> <tr><th>PRICE</th></tr> </thead> <tbody> <tr><td>1-24</td><td>\$81.82</td></tr> <tr><td>25-49</td><td>\$77.73</td></tr> <tr><td>50-99</td><td>\$73.64</td></tr> <tr><td>100+</td><td>\$70.37</td></tr> </tbody> </table> <p>75 Ohm Mini SMB Jack to 75 Ohm BNC Male Model No: PE9618</p>	PRICE	1-24	\$81.82	25-49	\$77.73	50-99	\$73.64	100+	\$70.37	 <table border="1"> <thead> <tr><th>PRICE</th></tr> </thead> <tbody> <tr><td>1-24</td><td>\$91.32</td></tr> <tr><td>25-49</td><td>\$86.75</td></tr> <tr><td>50-99</td><td>\$82.19</td></tr> <tr><td>100+</td><td>\$78.54</td></tr> </tbody> </table> <p>75 Ohm Mini SMB Jack to 75 Ohm BNC Female Model No: PE9619</p>	PRICE	1-24	\$91.32	25-49	\$86.75	50-99	\$82.19	100+	\$78.54	<div style="background-color: #333; color: white; text-align: center; padding: 10px;"> 75 Ohm N In-Series  </div>									
PRICE																																																		
1-24	\$77.08																																																	
25-49	\$73.23																																																	
50-99	\$69.37																																																	
100+	\$66.29																																																	
PRICE																																																		
1-24	\$64.16																																																	
25-49	\$60.95																																																	
50-99	\$57.74																																																	
100+	\$55.18																																																	
PRICE																																																		
1-24	\$81.82																																																	
25-49	\$77.73																																																	
50-99	\$73.64																																																	
100+	\$70.37																																																	
PRICE																																																		
1-24	\$91.32																																																	
25-49	\$86.75																																																	
50-99	\$82.19																																																	
100+	\$78.54																																																	
6	 <table border="1"> <thead> <tr><th>PRICE</th></tr> </thead> <tbody> <tr><td>1-24</td><td>\$37.28</td></tr> <tr><td>25-49</td><td>\$35.42</td></tr> <tr><td>50-99</td><td>\$33.55</td></tr> <tr><td>100+</td><td>\$32.06</td></tr> </tbody> </table> <p>75 Ohm N Male to 75 Ohm N Male Max. Freq. 1.5 GHz Model No: PE9308</p>	PRICE	1-24	\$37.28	25-49	\$35.42	50-99	\$33.55	100+	\$32.06	 <table border="1"> <thead> <tr><th>PRICE</th></tr> </thead> <tbody> <tr><td>1-24</td><td>\$37.53</td></tr> <tr><td>25-49</td><td>\$35.65</td></tr> <tr><td>50-99</td><td>\$33.78</td></tr> <tr><td>100+</td><td>\$32.28</td></tr> </tbody> </table> <p>75 Ohm N Male to 75 Ohm N Female Max. Freq. 1.5 GHz Model No: PE9391</p>	PRICE	1-24	\$37.53	25-49	\$35.65	50-99	\$33.78	100+	\$32.28	 <table border="1"> <thead> <tr><th>PRICE</th></tr> </thead> <tbody> <tr><td>1-24</td><td>\$47.38</td></tr> <tr><td>25-49</td><td>\$45.01</td></tr> <tr><td>50-99</td><td>\$42.64</td></tr> <tr><td>100+</td><td>\$40.75</td></tr> </tbody> </table> <p>75 Ohm N Male to 75 Ohm N Female Right Angle Max. Freq. 1.5 GHz Model No: PE9307</p>	PRICE	1-24	\$47.38	25-49	\$45.01	50-99	\$42.64	100+	\$40.75	 <table border="1"> <thead> <tr><th>PRICE</th></tr> </thead> <tbody> <tr><td>1-24</td><td>\$35.66</td></tr> <tr><td>25-49</td><td>\$33.88</td></tr> <tr><td>50-99</td><td>\$32.09</td></tr> <tr><td>100+</td><td>\$30.67</td></tr> </tbody> </table> <p>75 Ohm N Female to 75 Ohm N Female VSWR 1.3:1 to 1,000 MHz Model No: PE9306</p>	PRICE	1-24	\$35.66	25-49	\$33.88	50-99	\$32.09	100+	\$30.67	 <table border="1"> <thead> <tr><th>PRICE</th></tr> </thead> <tbody> <tr><td>1-24</td><td>\$114.06</td></tr> <tr><td>25-49</td><td>\$108.36</td></tr> <tr><td>50-99</td><td>\$102.65</td></tr> <tr><td>100+</td><td>\$98.09</td></tr> </tbody> </table> <p>75 Ohm N Female to 75 Ohm N Female Bulkhead-Mounting Hole G01 Model No: PE9417</p>	PRICE	1-24	\$114.06	25-49	\$108.36	50-99	\$102.65	100+	\$98.09
PRICE																																																		
1-24	\$37.28																																																	
25-49	\$35.42																																																	
50-99	\$33.55																																																	
100+	\$32.06																																																	
PRICE																																																		
1-24	\$37.53																																																	
25-49	\$35.65																																																	
50-99	\$33.78																																																	
100+	\$32.28																																																	
PRICE																																																		
1-24	\$47.38																																																	
25-49	\$45.01																																																	
50-99	\$42.64																																																	
100+	\$40.75																																																	
PRICE																																																		
1-24	\$35.66																																																	
25-49	\$33.88																																																	
50-99	\$32.09																																																	
100+	\$30.67																																																	
PRICE																																																		
1-24	\$114.06																																																	
25-49	\$108.36																																																	
50-99	\$102.65																																																	
100+	\$98.09																																																	
7	 <table border="1"> <thead> <tr><th>PRICE</th></tr> </thead> <tbody> <tr><td>1-24</td><td>\$54.97</td></tr> <tr><td>25-49</td><td>\$52.22</td></tr> <tr><td>50-99</td><td>\$49.47</td></tr> <tr><td>100+</td><td>\$47.27</td></tr> </tbody> </table> <p>75 Ohm N Female to 75 Ohm N Female Bulkhead VSWR 1.35:1 to 1.5 GHz Model No: PE9416</p>	PRICE	1-24	\$54.97	25-49	\$52.22	50-99	\$49.47	100+	\$47.27	<div style="background-color: #333; color: white; text-align: center; padding: 10px;"> 75 Ohm N Between Series  </div>	 <table border="1"> <thead> <tr><th>PRICE</th></tr> </thead> <tbody> <tr><td>1-24</td><td>\$70.56</td></tr> <tr><td>25-49</td><td>\$67.03</td></tr> <tr><td>50-99</td><td>\$63.50</td></tr> <tr><td>100+</td><td>\$60.68</td></tr> </tbody> </table> <p>75 Ohm N Male to 75 Ohm BNC Male Max. Freq. 1,000 MHz Model No: PE9370</p>	PRICE	1-24	\$70.56	25-49	\$67.03	50-99	\$63.50	100+	\$60.68	 <table border="1"> <thead> <tr><th>PRICE</th></tr> </thead> <tbody> <tr><td>1-24</td><td>\$36.43</td></tr> <tr><td>25-49</td><td>\$34.61</td></tr> <tr><td>50-99</td><td>\$32.79</td></tr> <tr><td>100+</td><td>\$31.33</td></tr> </tbody> </table> <p>75 Ohm N Male to 75 Ohm BNC Female VSWR 1.3:1 to 1,000 MHz Model No: PE9369</p>	PRICE	1-24	\$36.43	25-49	\$34.61	50-99	\$32.79	100+	\$31.33	 <table border="1"> <thead> <tr><th>PRICE</th></tr> </thead> <tbody> <tr><td>1-24</td><td>\$120.09</td></tr> <tr><td>25-49</td><td>\$114.09</td></tr> <tr><td>50-99</td><td>\$108.08</td></tr> <tr><td>100+</td><td>\$103.28</td></tr> </tbody> </table> <p>75 Ohm N Male to 75 Ohm F Male VSWR 1.3:1 to 3 GHz Model No: PE9738</p>	PRICE	1-24	\$120.09	25-49	\$114.09	50-99	\$108.08	100+	\$103.28									
PRICE																																																		
1-24	\$54.97																																																	
25-49	\$52.22																																																	
50-99	\$49.47																																																	
100+	\$47.27																																																	
PRICE																																																		
1-24	\$70.56																																																	
25-49	\$67.03																																																	
50-99	\$63.50																																																	
100+	\$60.68																																																	
PRICE																																																		
1-24	\$36.43																																																	
25-49	\$34.61																																																	
50-99	\$32.79																																																	
100+	\$31.33																																																	
PRICE																																																		
1-24	\$120.09																																																	
25-49	\$114.09																																																	
50-99	\$108.08																																																	
100+	\$103.28																																																	

ADAPTERS

See Adapter Locator on Pages 8-13

See Page 369 for Mounting Holes

Adapters

See Our Website For Current Pricing & Real-Time Stock Availability!

	A	B	C	D	E																																																		
1	 <table border="1"> <thead> <tr><th colspan="2">PRICE</th></tr> </thead> <tbody> <tr><td>1-24</td><td>\$46.30</td></tr> <tr><td>25-49</td><td>\$43.99</td></tr> <tr><td>50-99</td><td>\$41.67</td></tr> <tr><td>100+</td><td>\$39.82</td></tr> </tbody> </table> <p>75 Ohm N Male to 75 Ohm F Female Max. Freq. 1,000 MHz Model No: PE9396</p>	PRICE		1-24	\$46.30	25-49	\$43.99	50-99	\$41.67	100+	\$39.82	 <table border="1"> <thead> <tr><th colspan="2">PRICE</th></tr> </thead> <tbody> <tr><td>1-9</td><td>\$134.62</td></tr> <tr><td>10-24</td><td>\$127.89</td></tr> <tr><td>25-49</td><td>\$121.16</td></tr> <tr><td>50+</td><td>\$115.77</td></tr> </tbody> </table> <p>75 Ohm N Male to 75 Ohm F Female VSWR 1.3:1 to 3 GHz Model No: PE9737</p>	PRICE		1-9	\$134.62	10-24	\$127.89	25-49	\$121.16	50+	\$115.77	 <table border="1"> <thead> <tr><th colspan="2">PRICE</th></tr> </thead> <tbody> <tr><td>1-24</td><td>\$101.52</td></tr> <tr><td>25-49</td><td>\$96.44</td></tr> <tr><td>50-99</td><td>\$91.37</td></tr> <tr><td>100+</td><td>\$87.31</td></tr> </tbody> </table> <p>75 Ohm N Male to 75 Ohm Mini SMB Plug Model No: PE9612</p>	PRICE		1-24	\$101.52	25-49	\$96.44	50-99	\$91.37	100+	\$87.31	 <table border="1"> <thead> <tr><th colspan="2">PRICE</th></tr> </thead> <tbody> <tr><td>1-24</td><td>\$85.72</td></tr> <tr><td>25-49</td><td>\$81.43</td></tr> <tr><td>50-99</td><td>\$77.15</td></tr> <tr><td>100+</td><td>\$73.72</td></tr> </tbody> </table> <p>75 Ohm N Male to 75 Ohm Mini SMB Jack Model No: PE9614</p>	PRICE		1-24	\$85.72	25-49	\$81.43	50-99	\$77.15	100+	\$73.72	 <table border="1"> <thead> <tr><th colspan="2">PRICE</th></tr> </thead> <tbody> <tr><td>1-24</td><td>\$110.68</td></tr> <tr><td>25-49</td><td>\$105.15</td></tr> <tr><td>50-99</td><td>\$99.61</td></tr> <tr><td>100+</td><td>\$95.18</td></tr> </tbody> </table> <p>75 Ohm N Male to 75 Ohm SMB Plug Model No: PE9584</p>	PRICE		1-24	\$110.68	25-49	\$105.15	50-99	\$99.61	100+	\$95.18
PRICE																																																							
1-24	\$46.30																																																						
25-49	\$43.99																																																						
50-99	\$41.67																																																						
100+	\$39.82																																																						
PRICE																																																							
1-9	\$134.62																																																						
10-24	\$127.89																																																						
25-49	\$121.16																																																						
50+	\$115.77																																																						
PRICE																																																							
1-24	\$101.52																																																						
25-49	\$96.44																																																						
50-99	\$91.37																																																						
100+	\$87.31																																																						
PRICE																																																							
1-24	\$85.72																																																						
25-49	\$81.43																																																						
50-99	\$77.15																																																						
100+	\$73.72																																																						
PRICE																																																							
1-24	\$110.68																																																						
25-49	\$105.15																																																						
50-99	\$99.61																																																						
100+	\$95.18																																																						
2	 <table border="1"> <thead> <tr><th colspan="2">PRICE</th></tr> </thead> <tbody> <tr><td>1-24</td><td>\$87.29</td></tr> <tr><td>25-49</td><td>\$82.93</td></tr> <tr><td>50-99</td><td>\$78.56</td></tr> <tr><td>100+</td><td>\$75.07</td></tr> </tbody> </table> <p>75 Ohm N Male to 75 Ohm SMB Jack Model No: PE9582</p>	PRICE		1-24	\$87.29	25-49	\$82.93	50-99	\$78.56	100+	\$75.07	 <table border="1"> <thead> <tr><th colspan="2">PRICE</th></tr> </thead> <tbody> <tr><td>1-24</td><td>\$85.68</td></tr> <tr><td>25-49</td><td>\$81.40</td></tr> <tr><td>50-99</td><td>\$77.11</td></tr> <tr><td>100+</td><td>\$73.68</td></tr> </tbody> </table> <p>75 Ohm N Male to 75 Ohm SMC Plug Model No: PE9588</p>	PRICE		1-24	\$85.68	25-49	\$81.40	50-99	\$77.11	100+	\$73.68	 <table border="1"> <thead> <tr><th colspan="2">PRICE</th></tr> </thead> <tbody> <tr><td>1-24</td><td>\$88.65</td></tr> <tr><td>25-49</td><td>\$84.22</td></tr> <tr><td>50-99</td><td>\$79.79</td></tr> <tr><td>100+</td><td>\$76.24</td></tr> </tbody> </table> <p>75 Ohm N Male to 75 Ohm SMC Jack Model No: PE9586</p>	PRICE		1-24	\$88.65	25-49	\$84.22	50-99	\$79.79	100+	\$76.24	 <table border="1"> <thead> <tr><th colspan="2">PRICE</th></tr> </thead> <tbody> <tr><td>1-24</td><td>\$77.57</td></tr> <tr><td>25-49</td><td>\$73.69</td></tr> <tr><td>50-99</td><td>\$69.81</td></tr> <tr><td>100+</td><td>\$66.71</td></tr> </tbody> </table> <p>75 Ohm N Male to 75 Ohm TNC Male Max. Freq. 500 MHz Model No: PE9626</p>	PRICE		1-24	\$77.57	25-49	\$73.69	50-99	\$69.81	100+	\$66.71	 <table border="1"> <thead> <tr><th colspan="2">PRICE</th></tr> </thead> <tbody> <tr><td>1-24</td><td>\$53.27</td></tr> <tr><td>25-49</td><td>\$50.61</td></tr> <tr><td>50-99</td><td>\$47.94</td></tr> <tr><td>100+</td><td>\$45.81</td></tr> </tbody> </table> <p>75 Ohm N Male to 75 Ohm TNC Female Max. Freq. 500 MHz Model No: PE9627</p>	PRICE		1-24	\$53.27	25-49	\$50.61	50-99	\$47.94	100+	\$45.81
PRICE																																																							
1-24	\$87.29																																																						
25-49	\$82.93																																																						
50-99	\$78.56																																																						
100+	\$75.07																																																						
PRICE																																																							
1-24	\$85.68																																																						
25-49	\$81.40																																																						
50-99	\$77.11																																																						
100+	\$73.68																																																						
PRICE																																																							
1-24	\$88.65																																																						
25-49	\$84.22																																																						
50-99	\$79.79																																																						
100+	\$76.24																																																						
PRICE																																																							
1-24	\$77.57																																																						
25-49	\$73.69																																																						
50-99	\$69.81																																																						
100+	\$66.71																																																						
PRICE																																																							
1-24	\$53.27																																																						
25-49	\$50.61																																																						
50-99	\$47.94																																																						
100+	\$45.81																																																						
3	 <table border="1"> <thead> <tr><th colspan="2">PRICE</th></tr> </thead> <tbody> <tr><td>1-24</td><td>\$37.28</td></tr> <tr><td>25-49</td><td>\$35.42</td></tr> <tr><td>50-99</td><td>\$33.55</td></tr> <tr><td>100+</td><td>\$32.06</td></tr> </tbody> </table> <p>75 Ohm N Female to 75 Ohm BNC Male Max. Freq. 1,000 MHz Model No: PE9368</p>	PRICE		1-24	\$37.28	25-49	\$35.42	50-99	\$33.55	100+	\$32.06	 <table border="1"> <thead> <tr><th colspan="2">PRICE</th></tr> </thead> <tbody> <tr><td>1-24</td><td>\$49.17</td></tr> <tr><td>25-49</td><td>\$46.71</td></tr> <tr><td>50-99</td><td>\$44.25</td></tr> <tr><td>100+</td><td>\$42.29</td></tr> </tbody> </table> <p>75 Ohm N Female to 75 Ohm BNC Female Max. Freq. 1,000 MHz Model No: PE9371</p>	PRICE		1-24	\$49.17	25-49	\$46.71	50-99	\$44.25	100+	\$42.29	 <table border="1"> <thead> <tr><th colspan="2">PRICE</th></tr> </thead> <tbody> <tr><td>1-24</td><td>\$48.56</td></tr> <tr><td>25-49</td><td>\$46.13</td></tr> <tr><td>50-99</td><td>\$43.70</td></tr> <tr><td>100+</td><td>\$41.76</td></tr> </tbody> </table> <p>75 Ohm N Female to 75 Ohm F Male VSWR 1.3:1 to 3 GHz Model No: PE9397</p>	PRICE		1-24	\$48.56	25-49	\$46.13	50-99	\$43.70	100+	\$41.76	 <table border="1"> <thead> <tr><th colspan="2">PRICE</th></tr> </thead> <tbody> <tr><td>1-24</td><td>\$117.50</td></tr> <tr><td>25-49</td><td>\$111.63</td></tr> <tr><td>50-99</td><td>\$105.75</td></tr> <tr><td>100+</td><td>\$101.05</td></tr> </tbody> </table> <p>75 Ohm N Female to 75 Ohm F Male VSWR 1.3:1 to 3 GHz Model No: PE9739</p>	PRICE		1-24	\$117.50	25-49	\$111.63	50-99	\$105.75	100+	\$101.05	 <table border="1"> <thead> <tr><th colspan="2">PRICE</th></tr> </thead> <tbody> <tr><td>1-9</td><td>\$154.28</td></tr> <tr><td>10-24</td><td>\$146.57</td></tr> <tr><td>25-49</td><td>\$138.85</td></tr> <tr><td>50+</td><td>\$132.68</td></tr> </tbody> </table> <p>75 Ohm N Female to 75 Ohm F Female VSWR 1.3:1 to 3 GHz Model No: PE9740</p>	PRICE		1-9	\$154.28	10-24	\$146.57	25-49	\$138.85	50+	\$132.68
PRICE																																																							
1-24	\$37.28																																																						
25-49	\$35.42																																																						
50-99	\$33.55																																																						
100+	\$32.06																																																						
PRICE																																																							
1-24	\$49.17																																																						
25-49	\$46.71																																																						
50-99	\$44.25																																																						
100+	\$42.29																																																						
PRICE																																																							
1-24	\$48.56																																																						
25-49	\$46.13																																																						
50-99	\$43.70																																																						
100+	\$41.76																																																						
PRICE																																																							
1-24	\$117.50																																																						
25-49	\$111.63																																																						
50-99	\$105.75																																																						
100+	\$101.05																																																						
PRICE																																																							
1-9	\$154.28																																																						
10-24	\$146.57																																																						
25-49	\$138.85																																																						
50+	\$132.68																																																						
4	 <table border="1"> <thead> <tr><th colspan="2">PRICE</th></tr> </thead> <tbody> <tr><td>1-9</td><td>\$115.41</td></tr> <tr><td>10-24</td><td>\$109.64</td></tr> <tr><td>25-49</td><td>\$103.87</td></tr> <tr><td>50+</td><td>\$99.25</td></tr> </tbody> </table> <p>75 Ohm N Female to 75 Ohm Mini SMB Plug Model No: PE9613</p>	PRICE		1-9	\$115.41	10-24	\$109.64	25-49	\$103.87	50+	\$99.25	 <table border="1"> <thead> <tr><th colspan="2">PRICE</th></tr> </thead> <tbody> <tr><td>1-24</td><td>\$89.14</td></tr> <tr><td>25-49</td><td>\$84.68</td></tr> <tr><td>50-99</td><td>\$80.23</td></tr> <tr><td>100+</td><td>\$76.66</td></tr> </tbody> </table> <p>75 Ohm N Female to 75 Ohm Mini SMB Jack Max. Freq. 1,000 MHz Model No: PE9615</p>	PRICE		1-24	\$89.14	25-49	\$84.68	50-99	\$80.23	100+	\$76.66	 <table border="1"> <thead> <tr><th colspan="2">PRICE</th></tr> </thead> <tbody> <tr><td>1-24</td><td>\$119.65</td></tr> <tr><td>25-49</td><td>\$113.67</td></tr> <tr><td>50-99</td><td>\$107.69</td></tr> <tr><td>100+</td><td>\$102.90</td></tr> </tbody> </table> <p>75 Ohm N Female to 75 Ohm SMB Plug Model No: PE9585</p>	PRICE		1-24	\$119.65	25-49	\$113.67	50-99	\$107.69	100+	\$102.90	 <table border="1"> <thead> <tr><th colspan="2">PRICE</th></tr> </thead> <tbody> <tr><td>1-24</td><td>\$102.87</td></tr> <tr><td>25-49</td><td>\$97.73</td></tr> <tr><td>50-99</td><td>\$92.58</td></tr> <tr><td>100+</td><td>\$88.47</td></tr> </tbody> </table> <p>75 Ohm N Female to 75 Ohm SMB Jack Model No: PE9583</p>	PRICE		1-24	\$102.87	25-49	\$97.73	50-99	\$92.58	100+	\$88.47	 <table border="1"> <thead> <tr><th colspan="2">PRICE</th></tr> </thead> <tbody> <tr><td>1-24</td><td>\$95.26</td></tr> <tr><td>25-49</td><td>\$90.50</td></tr> <tr><td>50-99</td><td>\$85.73</td></tr> <tr><td>100+</td><td>\$81.92</td></tr> </tbody> </table> <p>75 Ohm N Female to 75 Ohm SMC Plug Model No: PE9589</p>	PRICE		1-24	\$95.26	25-49	\$90.50	50-99	\$85.73	100+	\$81.92
PRICE																																																							
1-9	\$115.41																																																						
10-24	\$109.64																																																						
25-49	\$103.87																																																						
50+	\$99.25																																																						
PRICE																																																							
1-24	\$89.14																																																						
25-49	\$84.68																																																						
50-99	\$80.23																																																						
100+	\$76.66																																																						
PRICE																																																							
1-24	\$119.65																																																						
25-49	\$113.67																																																						
50-99	\$107.69																																																						
100+	\$102.90																																																						
PRICE																																																							
1-24	\$102.87																																																						
25-49	\$97.73																																																						
50-99	\$92.58																																																						
100+	\$88.47																																																						
PRICE																																																							
1-24	\$95.26																																																						
25-49	\$90.50																																																						
50-99	\$85.73																																																						
100+	\$81.92																																																						
5	 <table border="1"> <thead> <tr><th colspan="2">PRICE</th></tr> </thead> <tbody> <tr><td>1-24</td><td>\$94.86</td></tr> <tr><td>25-49</td><td>\$90.12</td></tr> <tr><td>50-99</td><td>\$85.37</td></tr> <tr><td>100+</td><td>\$81.58</td></tr> </tbody> </table> <p>75 Ohm N Female to 75 Ohm SMC Jack Model No: PE9587</p>	PRICE		1-24	\$94.86	25-49	\$90.12	50-99	\$85.37	100+	\$81.58	 <table border="1"> <thead> <tr><th colspan="2">PRICE</th></tr> </thead> <tbody> <tr><td>1-24</td><td>\$53.27</td></tr> <tr><td>25-49</td><td>\$50.61</td></tr> <tr><td>50-99</td><td>\$47.94</td></tr> <tr><td>100+</td><td>\$45.81</td></tr> </tbody> </table> <p>75 Ohm N Female to 75 Ohm TNC Male Max. Freq. 500 MHz Model No: PE9628</p>	PRICE		1-24	\$53.27	25-49	\$50.61	50-99	\$47.94	100+	\$45.81	 <table border="1"> <thead> <tr><th colspan="2">PRICE</th></tr> </thead> <tbody> <tr><td>1-24</td><td>\$53.27</td></tr> <tr><td>25-49</td><td>\$50.61</td></tr> <tr><td>50-99</td><td>\$47.94</td></tr> <tr><td>100+</td><td>\$45.81</td></tr> </tbody> </table> <p>75 Ohm N Female to 75 Ohm TNC Female Max. Freq. 1,000 MHz Model No: PE9629</p>	PRICE		1-24	\$53.27	25-49	\$50.61	50-99	\$47.94	100+	\$45.81	<p>75 Ohm PAL In-Series</p> 		 <table border="1"> <thead> <tr><th colspan="2">PRICE</th></tr> </thead> <tbody> <tr><td>1-24</td><td>\$11.81</td></tr> <tr><td>25-49</td><td>\$11.22</td></tr> <tr><td>50-99</td><td>\$10.63</td></tr> <tr><td>100+</td><td>\$10.16</td></tr> </tbody> </table> <p>75 Ohm PAL Plug to 75 Ohm PAL Plug Model No: PE9680</p>	PRICE		1-24	\$11.81	25-49	\$11.22	50-99	\$10.63	100+	\$10.16									
PRICE																																																							
1-24	\$94.86																																																						
25-49	\$90.12																																																						
50-99	\$85.37																																																						
100+	\$81.58																																																						
PRICE																																																							
1-24	\$53.27																																																						
25-49	\$50.61																																																						
50-99	\$47.94																																																						
100+	\$45.81																																																						
PRICE																																																							
1-24	\$53.27																																																						
25-49	\$50.61																																																						
50-99	\$47.94																																																						
100+	\$45.81																																																						
PRICE																																																							
1-24	\$11.81																																																						
25-49	\$11.22																																																						
50-99	\$10.63																																																						
100+	\$10.16																																																						
6	<p>75 Ohm SMB In-Series</p> 		 <table border="1"> <thead> <tr><th colspan="2">PRICE</th></tr> </thead> <tbody> <tr><td>1-24</td><td>\$61.18</td></tr> <tr><td>25-49</td><td>\$58.12</td></tr> <tr><td>50-99</td><td>\$55.06</td></tr> <tr><td>100+</td><td>\$52.61</td></tr> </tbody> </table> <p>75 Ohm SMB Plug to 75 Ohm SMB Plug Model No: PE9271</p>	PRICE		1-24	\$61.18	25-49	\$58.12	50-99	\$55.06	100+	\$52.61	 <table border="1"> <thead> <tr><th colspan="2">PRICE</th></tr> </thead> <tbody> <tr><td>1-24</td><td>\$66.37</td></tr> <tr><td>25-49</td><td>\$63.05</td></tr> <tr><td>50-99</td><td>\$59.73</td></tr> <tr><td>100+</td><td>\$57.08</td></tr> </tbody> </table> <p>75 Ohm SMB Jack to 75 Ohm SMB Plug Tee Model No: PE9245</p>	PRICE		1-24	\$66.37	25-49	\$63.05	50-99	\$59.73	100+	\$57.08	 <table border="1"> <thead> <tr><th colspan="2">PRICE</th></tr> </thead> <tbody> <tr><td>1-24</td><td>\$66.81</td></tr> <tr><td>25-49</td><td>\$63.47</td></tr> <tr><td>50-99</td><td>\$60.13</td></tr> <tr><td>100+</td><td>\$57.46</td></tr> </tbody> </table> <p>75 Ohm SMB Jack to 75 Ohm SMB Jack Max. Freq. 4 GHz Model No: PE9248</p>	PRICE		1-24	\$66.81	25-49	\$63.47	50-99	\$60.13	100+	\$57.46	<p>75 Ohm SMB Between Series</p> 																			
PRICE																																																							
1-24	\$61.18																																																						
25-49	\$58.12																																																						
50-99	\$55.06																																																						
100+	\$52.61																																																						
PRICE																																																							
1-24	\$66.37																																																						
25-49	\$63.05																																																						
50-99	\$59.73																																																						
100+	\$57.08																																																						
PRICE																																																							
1-24	\$66.81																																																						
25-49	\$63.47																																																						
50-99	\$60.13																																																						
100+	\$57.46																																																						
7	 <table border="1"> <thead> <tr><th colspan="2">PRICE</th></tr> </thead> <tbody> <tr><td>1-24</td><td>\$66.06</td></tr> <tr><td>25-49</td><td>\$62.76</td></tr> <tr><td>50-99</td><td>\$59.45</td></tr> <tr><td>100+</td><td>\$56.81</td></tr> </tbody> </table> <p>75 Ohm SMB Plug to BNC Female Model No: PE9232</p>	PRICE		1-24	\$66.06	25-49	\$62.76	50-99	\$59.45	100+	\$56.81	 <table border="1"> <thead> <tr><th colspan="2">PRICE</th></tr> </thead> <tbody> <tr><td>1-24</td><td>\$63.51</td></tr> <tr><td>25-49</td><td>\$60.33</td></tr> <tr><td>50-99</td><td>\$57.16</td></tr> <tr><td>100+</td><td>\$54.62</td></tr> </tbody> </table> <p>75 Ohm SMB Plug to 75 Ohm Mini SMB Jack Max. Freq. 2 GHz Model No: PE9736</p>	PRICE		1-24	\$63.51	25-49	\$60.33	50-99	\$57.16	100+	\$54.62	 <table border="1"> <thead> <tr><th colspan="2">PRICE</th></tr> </thead> <tbody> <tr><td>1-24</td><td>\$62.40</td></tr> <tr><td>25-49</td><td>\$59.28</td></tr> <tr><td>50-99</td><td>\$56.16</td></tr> <tr><td>100+</td><td>\$53.66</td></tr> </tbody> </table> <p>75 Ohm SMB Jack to BNC Male Model No: PE9229</p>	PRICE		1-24	\$62.40	25-49	\$59.28	50-99	\$56.16	100+	\$53.66	 <table border="1"> <thead> <tr><th colspan="2">PRICE</th></tr> </thead> <tbody> <tr><td>1-24</td><td>\$71.18</td></tr> <tr><td>25-49</td><td>\$67.62</td></tr> <tr><td>50-99</td><td>\$64.06</td></tr> <tr><td>100+</td><td>\$61.21</td></tr> </tbody> </table> <p>75 Ohm SMB Jack to 75 Ohm Mini SMB Plug Model No: PE9735</p>	PRICE		1-24	\$71.18	25-49	\$67.62	50-99	\$64.06	100+	\$61.21	<p>75 Ohm SMC In-Series</p> 										
PRICE																																																							
1-24	\$66.06																																																						
25-49	\$62.76																																																						
50-99	\$59.45																																																						
100+	\$56.81																																																						
PRICE																																																							
1-24	\$63.51																																																						
25-49	\$60.33																																																						
50-99	\$57.16																																																						
100+	\$54.62																																																						
PRICE																																																							
1-24	\$62.40																																																						
25-49	\$59.28																																																						
50-99	\$56.16																																																						
100+	\$53.66																																																						
PRICE																																																							
1-24	\$71.18																																																						
25-49	\$67.62																																																						
50-99	\$64.06																																																						
100+	\$61.21																																																						

ADAPTERS

See Adapter Locator on Pages 8-13

See Page 369 for Mounting Holes

	A	B	C	D	E																																								
1	 <table border="1"> <thead> <tr> <th colspan="2">PRICE</th> </tr> </thead> <tbody> <tr> <td>1-24</td> <td>\$38.72</td> </tr> <tr> <td>25-49</td> <td>\$36.78</td> </tr> <tr> <td>50-99</td> <td>\$34.85</td> </tr> <tr> <td>100+</td> <td>\$33.30</td> </tr> </tbody> </table> <p>75 Ohm SMC Plug to 75 Ohm SMC Plug</p> <p>Model No: PE9272</p>	PRICE		1-24	\$38.72	25-49	\$36.78	50-99	\$34.85	100+	\$33.30	 <table border="1"> <thead> <tr> <th colspan="2">PRICE</th> </tr> </thead> <tbody> <tr> <td>1-24</td> <td>\$56.49</td> </tr> <tr> <td>25-49</td> <td>\$53.67</td> </tr> <tr> <td>50-99</td> <td>\$50.84</td> </tr> <tr> <td>100+</td> <td>\$48.58</td> </tr> </tbody> </table> <p>75 Ohm SMC Jack to 75 Ohm SMC Plug Tee</p> <p>Model No: PE9244</p>	PRICE		1-24	\$56.49	25-49	\$53.67	50-99	\$50.84	100+	\$48.58	 <table border="1"> <thead> <tr> <th colspan="2">PRICE</th> </tr> </thead> <tbody> <tr> <td>1-24</td> <td>\$42.52</td> </tr> <tr> <td>25-49</td> <td>\$40.39</td> </tr> <tr> <td>50-99</td> <td>\$38.27</td> </tr> <tr> <td>100+</td> <td>\$36.57</td> </tr> </tbody> </table> <p>75 Ohm SMC Jack to 75 Ohm SMC Jack</p> <p>Model No: PE9227</p>	PRICE		1-24	\$42.52	25-49	\$40.39	50-99	\$38.27	100+	\$36.57	 <table border="1"> <thead> <tr> <th colspan="2">PRICE</th> </tr> </thead> <tbody> <tr> <td>1-24</td> <td>\$56.37</td> </tr> <tr> <td>25-49</td> <td>\$53.55</td> </tr> <tr> <td>50-99</td> <td>\$50.73</td> </tr> <tr> <td>100+</td> <td>\$48.48</td> </tr> </tbody> </table> <p>75 Ohm SMC Jack to 75 Ohm SMC Jack Bulkhead-Mounting Hole B03</p> <p>Model No: PE9228</p>	PRICE		1-24	\$56.37	25-49	\$53.55	50-99	\$50.73	100+	\$48.48	<p>75 Ohm SMC Between Series</p> <p>→</p>
	PRICE																																												
1-24	\$38.72																																												
25-49	\$36.78																																												
50-99	\$34.85																																												
100+	\$33.30																																												
PRICE																																													
1-24	\$56.49																																												
25-49	\$53.67																																												
50-99	\$50.84																																												
100+	\$48.58																																												
PRICE																																													
1-24	\$42.52																																												
25-49	\$40.39																																												
50-99	\$38.27																																												
100+	\$36.57																																												
PRICE																																													
1-24	\$56.37																																												
25-49	\$53.55																																												
50-99	\$50.73																																												
100+	\$48.48																																												
2	 <table border="1"> <thead> <tr> <th colspan="2">PRICE</th> </tr> </thead> <tbody> <tr> <td>1-24</td> <td>\$62.31</td> </tr> <tr> <td>25-49</td> <td>\$59.19</td> </tr> <tr> <td>50-99</td> <td>\$56.08</td> </tr> <tr> <td>100+</td> <td>\$53.59</td> </tr> </tbody> </table> <p>75 Ohm SMC Jack to BNC Female</p> <p>Model No: PE9235</p>	PRICE		1-24	\$62.31	25-49	\$59.19	50-99	\$56.08	100+	\$53.59	<p>75 Ohm TNC In-Series</p> <p>→</p>	 <table border="1"> <thead> <tr> <th colspan="2">PRICE</th> </tr> </thead> <tbody> <tr> <td>1-24</td> <td>\$96.05</td> </tr> <tr> <td>25-49</td> <td>\$91.25</td> </tr> <tr> <td>50-99</td> <td>\$86.45</td> </tr> <tr> <td>100+</td> <td>\$82.60</td> </tr> </tbody> </table> <p>75 Ohm TNC Male to 75 Ohm TNC Female Right Angle</p> <p>Model No: PE9623</p>	PRICE		1-24	\$96.05	25-49	\$91.25	50-99	\$86.45	100+	\$82.60	 <table border="1"> <thead> <tr> <th colspan="2">PRICE</th> </tr> </thead> <tbody> <tr> <td>1-24</td> <td>\$38.18</td> </tr> <tr> <td>25-49</td> <td>\$36.27</td> </tr> <tr> <td>50-99</td> <td>\$34.36</td> </tr> <tr> <td>100+</td> <td>\$32.83</td> </tr> </tbody> </table> <p>75 Ohm TNC Female to 75 Ohm TNC Female</p> <p>Max. Freq. 1,000 MHz</p> <p>Model No: PE9622</p>	PRICE		1-24	\$38.18	25-49	\$36.27	50-99	\$34.36	100+	\$32.83	 <table border="1"> <thead> <tr> <th colspan="2">PRICE</th> </tr> </thead> <tbody> <tr> <td>1-24</td> <td>\$53.27</td> </tr> <tr> <td>25-49</td> <td>\$50.61</td> </tr> <tr> <td>50-99</td> <td>\$47.94</td> </tr> <tr> <td>100+</td> <td>\$45.81</td> </tr> </tbody> </table> <p>75 Ohm TNC Female to 75 Ohm TNC Female Bulkhead-Mounting Hole B06</p> <p>Max. Freq. 1,000 MHz</p> <p>Model No: PE9625</p>	PRICE		1-24	\$53.27	25-49	\$50.61	50-99	\$47.94	100+	\$45.81
	PRICE																																												
1-24	\$62.31																																												
25-49	\$59.19																																												
50-99	\$56.08																																												
100+	\$53.59																																												
PRICE																																													
1-24	\$96.05																																												
25-49	\$91.25																																												
50-99	\$86.45																																												
100+	\$82.60																																												
PRICE																																													
1-24	\$38.18																																												
25-49	\$36.27																																												
50-99	\$34.36																																												
100+	\$32.83																																												
PRICE																																													
1-24	\$53.27																																												
25-49	\$50.61																																												
50-99	\$47.94																																												
100+	\$45.81																																												
3	 <table border="1"> <thead> <tr> <th colspan="2">PRICE</th> </tr> </thead> <tbody> <tr> <td>1-24</td> <td>\$90.90</td> </tr> <tr> <td>25-49</td> <td>\$86.36</td> </tr> <tr> <td>50-99</td> <td>\$81.81</td> </tr> <tr> <td>100+</td> <td>\$78.17</td> </tr> </tbody> </table> <p>75 Ohm TNC Female to 75 Ohm TNC Female Bulkhead</p> <p>Model No: PE9624</p>	PRICE		1-24	\$90.90	25-49	\$86.36	50-99	\$81.81	100+	\$78.17	<p>75 Ohm TNC Between Series</p> <p>→</p>	 <table border="1"> <thead> <tr> <th colspan="2">PRICE</th> </tr> </thead> <tbody> <tr> <td>1-24</td> <td>\$28.65</td> </tr> <tr> <td>25-49</td> <td>\$27.22</td> </tr> <tr> <td>50-99</td> <td>\$25.79</td> </tr> <tr> <td>100+</td> <td>\$24.64</td> </tr> </tbody> </table> <p>75 Ohm TNC Male to 75 Ohm BNC Female</p> <p>Max. Freq. 500 MHz</p> <p>Model No: PE9631</p>	PRICE		1-24	\$28.65	25-49	\$27.22	50-99	\$25.79	100+	\$24.64	 <table border="1"> <thead> <tr> <th colspan="2">PRICE</th> </tr> </thead> <tbody> <tr> <td>1-24</td> <td>\$80.60</td> </tr> <tr> <td>25-49</td> <td>\$76.57</td> </tr> <tr> <td>50-99</td> <td>\$72.54</td> </tr> <tr> <td>100+</td> <td>\$69.32</td> </tr> </tbody> </table> <p>75 Ohm TNC Male to 75 Ohm F Male</p> <p>VSWR 1.35:1 to 2 GHz</p> <p>Model No: PE91081</p>	PRICE		1-24	\$80.60	25-49	\$76.57	50-99	\$72.54	100+	\$69.32	 <table border="1"> <thead> <tr> <th colspan="2">PRICE</th> </tr> </thead> <tbody> <tr> <td>1-24</td> <td>\$71.66</td> </tr> <tr> <td>25-49</td> <td>\$68.08</td> </tr> <tr> <td>50-99</td> <td>\$64.49</td> </tr> <tr> <td>100+</td> <td>\$61.63</td> </tr> </tbody> </table> <p>75 Ohm TNC Male to 75 Ohm F Female</p> <p>VSWR 1.35:1 to 2 GHz</p> <p>Model No: PE91080</p>	PRICE		1-24	\$71.66	25-49	\$68.08	50-99	\$64.49	100+	\$61.63
	PRICE																																												
1-24	\$90.90																																												
25-49	\$86.36																																												
50-99	\$81.81																																												
100+	\$78.17																																												
PRICE																																													
1-24	\$28.65																																												
25-49	\$27.22																																												
50-99	\$25.79																																												
100+	\$24.64																																												
PRICE																																													
1-24	\$80.60																																												
25-49	\$76.57																																												
50-99	\$72.54																																												
100+	\$69.32																																												
PRICE																																													
1-24	\$71.66																																												
25-49	\$68.08																																												
50-99	\$64.49																																												
100+	\$61.63																																												
4	 <table border="1"> <thead> <tr> <th colspan="2">PRICE</th> </tr> </thead> <tbody> <tr> <td>1-24</td> <td>\$53.27</td> </tr> <tr> <td>25-49</td> <td>\$50.61</td> </tr> <tr> <td>50-99</td> <td>\$47.94</td> </tr> <tr> <td>100+</td> <td>\$45.81</td> </tr> </tbody> </table> <p>75 Ohm TNC Female to 75 Ohm BNC Male</p> <p>Max. Freq. 1,000 MHz</p> <p>Model No: PE9630</p>	PRICE		1-24	\$53.27	25-49	\$50.61	50-99	\$47.94	100+	\$45.81	 <table border="1"> <thead> <tr> <th colspan="2">PRICE</th> </tr> </thead> <tbody> <tr> <td>1-24</td> <td>\$96.45</td> </tr> <tr> <td>25-49</td> <td>\$91.63</td> </tr> <tr> <td>50-99</td> <td>\$86.81</td> </tr> <tr> <td>100+</td> <td>\$82.95</td> </tr> </tbody> </table> <p>75 Ohm TNC Female to 75 Ohm F Male</p> <p>VSWR 1.35:1 to 2 GHz</p> <p>Model No: PE91083</p>	PRICE		1-24	\$96.45	25-49	\$91.63	50-99	\$86.81	100+	\$82.95	 <table border="1"> <thead> <tr> <th colspan="2">PRICE</th> </tr> </thead> <tbody> <tr> <td>1-24</td> <td>\$80.61</td> </tr> <tr> <td>25-49</td> <td>\$77.39</td> </tr> <tr> <td>50-99</td> <td>\$74.97</td> </tr> <tr> <td>100+</td> <td>\$73.36</td> </tr> </tbody> </table> <p>75 Ohm TNC Female to 75 Ohm F Female</p> <p>VSWR 1.35:1 to 2 GHz</p> <p>Model No: PE91082</p>	PRICE		1-24	\$80.61	25-49	\$77.39	50-99	\$74.97	100+	\$73.36	<p>BNC Twinax In-Series</p> <p>→</p>	 <table border="1"> <thead> <tr> <th colspan="2">PRICE</th> </tr> </thead> <tbody> <tr> <td>1-24</td> <td>\$85.44</td> </tr> <tr> <td>25-49</td> <td>\$81.17</td> </tr> <tr> <td>50-99</td> <td>\$76.90</td> </tr> <tr> <td>100+</td> <td>\$73.48</td> </tr> </tbody> </table> <p>78 Ohm BNC Twinax Plug to 78 Ohm BNC Twinax Plug</p> <p>Model No: PE9376</p>	PRICE		1-24	\$85.44	25-49	\$81.17	50-99	\$76.90	100+	\$73.48
	PRICE																																												
1-24	\$53.27																																												
25-49	\$50.61																																												
50-99	\$47.94																																												
100+	\$45.81																																												
PRICE																																													
1-24	\$96.45																																												
25-49	\$91.63																																												
50-99	\$86.81																																												
100+	\$82.95																																												
PRICE																																													
1-24	\$80.61																																												
25-49	\$77.39																																												
50-99	\$74.97																																												
100+	\$73.36																																												
PRICE																																													
1-24	\$85.44																																												
25-49	\$81.17																																												
50-99	\$76.90																																												
100+	\$73.48																																												
5	 <table border="1"> <thead> <tr> <th colspan="2">PRICE</th> </tr> </thead> <tbody> <tr> <td>1-24</td> <td>\$84.88</td> </tr> <tr> <td>25-49</td> <td>\$80.64</td> </tr> <tr> <td>50-99</td> <td>\$76.39</td> </tr> <tr> <td>100+</td> <td>\$73.00</td> </tr> </tbody> </table> <p>78 Ohm BNC Twinax Plug to 78 Ohm BNC Twinax Jack Right Angle</p> <p>Model No: PE9377</p>	PRICE		1-24	\$84.88	25-49	\$80.64	50-99	\$76.39	100+	\$73.00	 <table border="1"> <thead> <tr> <th colspan="2">PRICE</th> </tr> </thead> <tbody> <tr> <td>1-24</td> <td>\$84.49</td> </tr> <tr> <td>25-49</td> <td>\$80.27</td> </tr> <tr> <td>50-99</td> <td>\$76.04</td> </tr> <tr> <td>100+</td> <td>\$72.66</td> </tr> </tbody> </table> <p>78 Ohm BNC Twinax Jack to 78 Ohm BNC Twinax Plug Tee</p> <p>Model No: PE9375</p>	PRICE		1-24	\$84.49	25-49	\$80.27	50-99	\$76.04	100+	\$72.66	 <table border="1"> <thead> <tr> <th colspan="2">PRICE</th> </tr> </thead> <tbody> <tr> <td>1-24</td> <td>\$37.93</td> </tr> <tr> <td>25-49</td> <td>\$36.03</td> </tr> <tr> <td>50-99</td> <td>\$34.14</td> </tr> <tr> <td>100+</td> <td>\$32.62</td> </tr> </tbody> </table> <p>78 Ohm BNC Twinax Jack to 78 Ohm BNC Twinax Jack</p> <p>Max. Freq. 500 MHz</p> <p>Model No: PE9378</p>	PRICE		1-24	\$37.93	25-49	\$36.03	50-99	\$34.14	100+	\$32.62	 <table border="1"> <thead> <tr> <th colspan="2">PRICE</th> </tr> </thead> <tbody> <tr> <td>1-24</td> <td>\$47.69</td> </tr> <tr> <td>25-49</td> <td>\$45.31</td> </tr> <tr> <td>50-99</td> <td>\$42.92</td> </tr> <tr> <td>100+</td> <td>\$41.01</td> </tr> </tbody> </table> <p>78 Ohm BNC Twinax Jack to 78 Ohm BNC Twinax Jack Bulkhead</p> <p>Max. Freq. 500 MHz</p> <p>Model No: PE9280</p>	PRICE		1-24	\$47.69	25-49	\$45.31	50-99	\$42.92	100+	\$41.01	<p>3/4"-20 Twinax In-Series</p> <p>→</p>
	PRICE																																												
1-24	\$84.88																																												
25-49	\$80.64																																												
50-99	\$76.39																																												
100+	\$73.00																																												
PRICE																																													
1-24	\$84.49																																												
25-49	\$80.27																																												
50-99	\$76.04																																												
100+	\$72.66																																												
PRICE																																													
1-24	\$37.93																																												
25-49	\$36.03																																												
50-99	\$34.14																																												
100+	\$32.62																																												
PRICE																																													
1-24	\$47.69																																												
25-49	\$45.31																																												
50-99	\$42.92																																												
100+	\$41.01																																												
6	 <table border="1"> <thead> <tr> <th colspan="2">PRICE</th> </tr> </thead> <tbody> <tr> <td>1-24</td> <td>\$40.23</td> </tr> <tr> <td>25-49</td> <td>\$38.22</td> </tr> <tr> <td>50-99</td> <td>\$36.21</td> </tr> <tr> <td>100+</td> <td>\$34.60</td> </tr> </tbody> </table> <p>95 Ohm 3/4"-20 Twinax Female to 95 Ohm 3/4"-20 Twinax Male Tee</p> <p>Max. Freq. 400 MHz</p> <p>Model No: PE9374</p>	PRICE		1-24	\$40.23	25-49	\$38.22	50-99	\$36.21	100+	\$34.60	 <table border="1"> <thead> <tr> <th colspan="2">PRICE</th> </tr> </thead> <tbody> <tr> <td>1-24</td> <td>\$30.20</td> </tr> <tr> <td>25-49</td> <td>\$28.69</td> </tr> <tr> <td>50-99</td> <td>\$27.18</td> </tr> <tr> <td>100+</td> <td>\$25.97</td> </tr> </tbody> </table> <p>95 Ohm 3/4"-20 Twinax Female to 95 Ohm 3/4"-20 Twinax Female</p> <p>Model No: PE9199</p>	PRICE		1-24	\$30.20	25-49	\$28.69	50-99	\$27.18	100+	\$25.97	 <table border="1"> <thead> <tr> <th colspan="2">PRICE</th> </tr> </thead> <tbody> <tr> <td>1-24</td> <td>\$53.22</td> </tr> <tr> <td>25-49</td> <td>\$50.56</td> </tr> <tr> <td>50-99</td> <td>\$47.90</td> </tr> <tr> <td>100+</td> <td>\$45.77</td> </tr> </tbody> </table> <p>95 Ohm 3/4"-20 Twinax Female to 95 Ohm 3/4"-20 Twinax Female Tee</p> <p>Model No: PE9224</p>	PRICE		1-24	\$53.22	25-49	\$50.56	50-99	\$47.90	100+	\$45.77	 <table border="1"> <thead> <tr> <th colspan="2">PRICE</th> </tr> </thead> <tbody> <tr> <td>1-24</td> <td>\$52.18</td> </tr> <tr> <td>25-49</td> <td>\$49.57</td> </tr> <tr> <td>50-99</td> <td>\$46.96</td> </tr> <tr> <td>100+</td> <td>\$44.87</td> </tr> </tbody> </table> <p>95 Ohm 3/4"-20 Twinax Female to 95 Ohm 3/4"-20 Twinax Female Bulkhead</p> <p>Model No: PE9373</p>	PRICE		1-24	\$52.18	25-49	\$49.57	50-99	\$46.96	100+	\$44.87	<p>Banana Between Series</p> <p>→</p>
	PRICE																																												
1-24	\$40.23																																												
25-49	\$38.22																																												
50-99	\$36.21																																												
100+	\$34.60																																												
PRICE																																													
1-24	\$30.20																																												
25-49	\$28.69																																												
50-99	\$27.18																																												
100+	\$25.97																																												
PRICE																																													
1-24	\$53.22																																												
25-49	\$50.56																																												
50-99	\$47.90																																												
100+	\$45.77																																												
PRICE																																													
1-24	\$52.18																																												
25-49	\$49.57																																												
50-99	\$46.96																																												
100+	\$44.87																																												
7	 <table border="1"> <thead> <tr> <th colspan="2">PRICE</th> </tr> </thead> <tbody> <tr> <td>1-24</td> <td>\$47.64</td> </tr> <tr> <td>25-49</td> <td>\$45.26</td> </tr> <tr> <td>50-99</td> <td>\$42.88</td> </tr> <tr> <td>100+</td> <td>\$40.97</td> </tr> </tbody> </table> <p>Banana Plug to BNC Female</p> <p>Model No: PE9175</p>	PRICE		1-24	\$47.64	25-49	\$45.26	50-99	\$42.88	100+	\$40.97	<p>Non Constant Ohm BNC Triax In-Series</p> <p>→</p>	 <table border="1"> <thead> <tr> <th colspan="2">PRICE</th> </tr> </thead> <tbody> <tr> <td>1-9</td> <td>\$144.11</td> </tr> <tr> <td>10-24</td> <td>\$136.90</td> </tr> <tr> <td>25-49</td> <td>\$129.70</td> </tr> <tr> <td>50+</td> <td>\$123.93</td> </tr> </tbody> </table> <p>BNC Triax Male to BNC Triax Female Tee</p> <p>Max. Freq. 500 MHz</p> <p>Model No: PE91106</p>	PRICE		1-9	\$144.11	10-24	\$136.90	25-49	\$129.70	50+	\$123.93	 <table border="1"> <thead> <tr> <th colspan="2">PRICE</th> </tr> </thead> <tbody> <tr> <td>1-24</td> <td>\$39.74</td> </tr> <tr> <td>25-49</td> <td>\$37.75</td> </tr> <tr> <td>50-99</td> <td>\$35.77</td> </tr> <tr> <td>100+</td> <td>\$34.18</td> </tr> </tbody> </table> <p>BNC Triax Female to BNC Triax Female</p> <p>Max. Freq. 500 MHz</p> <p>Model No: PE91107</p>	PRICE		1-24	\$39.74	25-49	\$37.75	50-99	\$35.77	100+	\$34.18	 <table border="1"> <thead> <tr> <th colspan="2">PRICE</th> </tr> </thead> <tbody> <tr> <td>1-9</td> <td>\$146.82</td> </tr> <tr> <td>10-24</td> <td>\$139.48</td> </tr> <tr> <td>25-49</td> <td>\$132.14</td> </tr> <tr> <td>50+</td> <td>\$126.27</td> </tr> </tbody> </table> <p>BNC Triax Female to BNC Triax Female Bulkhead-Mounting Hole B15</p> <p>Max. Freq. 500 MHz</p> <p>Model No: PE91105</p>	PRICE		1-9	\$146.82	10-24	\$139.48	25-49	\$132.14	50+	\$126.27
	PRICE																																												
1-24	\$47.64																																												
25-49	\$45.26																																												
50-99	\$42.88																																												
100+	\$40.97																																												
PRICE																																													
1-9	\$144.11																																												
10-24	\$136.90																																												
25-49	\$129.70																																												
50+	\$123.93																																												
PRICE																																													
1-24	\$39.74																																												
25-49	\$37.75																																												
50-99	\$35.77																																												
100+	\$34.18																																												
PRICE																																													
1-9	\$146.82																																												
10-24	\$139.48																																												
25-49	\$132.14																																												
50+	\$126.27																																												

Amplifiers Selection Guide

3 Easy Ways to Find your Product.....

1. Search by PE Part Number

If you know the PE part number you are searching for, please reference our Part Number Index on Page [355](#).

2. Quick Reference Guide

Bi Directional Amplifiers.....	48
Broadband Amplifiers.....	48
USB Controlled.....	49
Bench Top.....	50
DC Coupled Amplifiers.....	50
Gain Block Amplifiers.....	50
Limiting Amplifiers.....	50
Log Amplifiers.....	51
Low Noise Amplifiers.....	51
Standard.....	51
Input Protected.....	52
Power Amplifiers.....	53
Power Amplifiers (<4W).....	53
High Power Amplifiers (>4W).....	54
GaN High Power Amplifiers.....	55
Variable Amplifiers.....	56
Amplifier Accessories.....	56

3. Amplifiers Locator

Frequency	Model No.	Page C/R	Frequency	Model No.	Page C/R	Frequency	Model No.	Page C/R	Frequency	Model No.	Page C/R		
DC to:			10 MHz to:			20 MHz to:			100 MHz to:				
17 MHz	PE15A86002	50 42	550 MHz	PE15A1044	51 62	3 GHz	PE15A1008	51 76	18 GHz	PE15A3255	49 63		
1.5 GHz	PE15A86001	50 43	600 MHz	PE15A1063	51 63		PE15A4017	53 41		PE15A3256	49 64		
2 GHz	PE15A86000	50 44	800 MHz	PE15A1048	51 64	4 GHz	PE15A1061	51 77		PE15A4052	53 45		
0.009 MHz to:					PE15A1065	51 65	30 MHz to:			PE15A4052F	53 46		
3 GHz	PE15A1007	51 55	1 GHz:			1.5 GHz	PE15A63002	52 21	26.5 GHz	PE15A7000	56 82		
0.01 MHz to:				PE15A1011	51 66		PE15A63003	52 22		PE15A3267	49 65		
500 MHz	PE15A1046	51 56		PE15A1049	51 67	2.5 GHz	PE15A5011	55 58		PE15A3280	49 66		
1.4 GHz	PE15A1055	51 57		PE15A1012	51 68	2.7 GHz	PE15B5003	48 1		PE15A3281	49 67		
2 GHz	PE15A1059	51 58		PE15A1013	51 69	3 GHz	PE15A4018	53 42	PE15A3282	49 68			
3 GHz	PE15A3308	49 56		PE15A1052	51 70	20 GHz	PE15A3254	49 62	PE15A3283	49 69			
0.03 MHz to:				PE15A63000	52 19	40 GHz	PE15A3023	48 7	40 GHz	PE15A3284	49 70		
600 MHz	PE15A1047	51 59	1.3 GHz	PE15A1054	51 71	40 MHz to:				PE15A3285	49 71		
0.1 MHz to:				PE1514	50 23	3 GHz	PE15A1060	51 78		PE15A3286	49 72		
10 GHz	PE15A3311	49 57		PE1528	50 24	50 MHz to:				PE15A3287	49 73		
0.15 MHz to:				PE1513	50 25	1 GHz	PE15A1009	51 72	PE15A3288	49 74			
230 MHz	PE15A5028	54 10		PE15A1009	51 72			PE1517	50 27	110 MHz to:	PE15A3289	49 75	
	PE15A5028F	54 11		PE15A4032	48 4			PE15A9001	51 79		6 GHz	PE15A3004	48 9
0.3 MHz to:				PE15A3269	49 60			PE15A1050	51 80		10 GHz	PE15A3001	48 10
6.5 GHz	PE15A3310	49 58		PE15A8001	50 26		PE15A1014	51 81	200 MHz to:				
0.5 MHz to:				PE15A3037	50 10		PE15A4009	53 43	2.5 GHz	PE1525	50 31		
500 MHz	PE15A5029	54 12	15 GHz	PE15A3036	48 5	1.2 GHz	PE15A1053	51 82	2.6 GHz	PE15A5084	53 47		
	PE15A5029F	54 13		PE15A4029	48 6	2 GHz	PE15A1042	51 83	300 MHz to:				
1 MHz to:				PE15A3272	49 61	4 GHz	PE15A8000	50 29	18 GHz	PE15A3021	48 11		
500 MHz	PE15A1045	51 60	20 MHz to:			18 GHz	PE15A3900	49 8	18 GHz	PE15A3021D	48 12		
1 GHz	PE15A5030	53 34	520 MHz	PE15A5065	53 38	40 GHz	PE15A3901	49 9		500 MHz to:			
	PE15A5030F	53 35		PE15A1051	51 73	60 MHz to:			1 GHz	PE15A5058	53 48		
3 GHz	PE15A3309	49 59		PE15A1064	51 74	6 GHz	PE15A4019	53 44	2 GHz	PE15A4038	48 13		
1.5 MHz to:				PE15A5031F	54 15	100 MHz to:				PE15A3014	48 14		
30 MHz	PE15A5055	53 36		PE15A4072	53 39	2 GHz	PE15A1066	51 84		PE15A3015	48 15		
100 MHz	PE15A5056	53 37		PE15A5057	53 40	3 GHz	PE1516	50 30		PE15A8004	50 32		
10 MHz to:				PE15A1057	51 75	6 GHz	PE15A5027	56 59	PE15A8005	50 33			
250 MHz	PE15A1043	51 61	20 MHz to:			12 GHz	PE15A3007	48 8					

Amplifiers Locator

Frequency	Model No.	Page C/R
500 MHz to:		
2.5 GHz	PE15A4039	48 16
	PE15A5059	56 60
	PE15A5060	56 61
2.8 GHz	PE15A5013	54 16
	PE15A1017	51 85
3 GHz	PE15A1018	51 86
	PE15A5032	56 62
	PE15A5032F	56 63
	PE15A2000	51 50
4 GHz	PE15A1068	51 87
	PE15A4053	53 49
	PE15A4053F	53 50
6 GHz	PE15A4037	48 17
10 GHz	PE15A3005	48 18
	PE15A3008	48 19
18 GHz	PE15A3263	48 20
	PE15A2003	51 51
20 GHz	PE15A3253	49 76
700 MHz to:		
2.2 GHz	PE15A5004	54 17
	PE15A1067	51 88
	PE15A5033	56 64
2.7 GHz	PE15A5033F	56 65
	PE15A5017	56 66
6 GHz	PE15A5017	56 66
	PE15A5017	56 66
800 MHz to:		
960 MHz	PE15A5040	54 18
	PE15A5041	54 19
1 GHz	PE15A5061	53 51
	PE15A5035	55 20
2 GHz	PE15A5035F	55 21
	PE15A5077	53 52
2.5 GHz	PE15A5020	55 22
	PE15A5062	56 67
4.2 GHz	PE15A5034F	53 53
	PE15A5034	53 54
5.5 GHz	PE15A3264	48 21
820 MHz to:		
960 MHz	PE15A4026	53 55
860 MHz to:		
960 MHz	PE15A5042	55 23
	PE15A5039	55 24
900 MHz to:		
1.2 GHz	PE15A63004	52 23
	PE15A63005	52 24
1 GHz to:		
1.4 GHz	PE15A63006	52 25
	PE15A6002	50 45
2 GHz	PE15A1000	51 89
	PE15A1019	52 90
	PE15A5063	56 68
	PE15A4025	53 56
	PE15A4016	53 57
	PE15A5036F	55 25
2.5 GHz	PE15A5036	55 26
	PE15A5082	55 27
	PE15A5081	55 28
	PE15A5085	53 58
	PE15A5083	53 59
	PE15A5026	56 69
3 GHz	PE15A5037	55 29
	PE15A5037F	55 30
4 GHz	PE1519	50 34
	PE15A1070	52 91
7 GHz	PE15A1075	52 26
12 GHz	PE15A1031	52 92
18 GHz	PE15A3262	48 22
20 GHz	PE15A3500	50 11
	PE15A3512	50 12
20 GHz	PE15A3513	50 13
	PE15A3278	49 77
23 GHz	PE15A1074	52 27
40 GHz	PE15A3514	50 14
	PE15A3515	50 15
1.2 GHz to:		
1.4 GHz	PE15A1023	52 93
	PE15A1024	52 94
	PE15A1005	52 95

Frequency	Model No.	Page C/R
1.2 GHz to:		
1.4 GHz	PE15A5001	55 31
	PE15A4010	53 60
1.6 GHz	PE15A1028	52 96
	PE15A5064	56 70
1.215 GHz to:		
1.4 GHz	PE15A1039	52 97
	PE15A1040	52 98
1.35 GHz to:		
1.39 GHz	PE15B5001	48 2
1.5 GHz to:		
3.5 GHz	PE15A5005	55 32
5 GHz	PE15A1034	52 99
1.7 GHz to:		
2 GHz	PE15A5014	55 33
2.4 GHz	PE15A5073	55 34
2.5 GHz	PE15A5015	55 35
1.8 GHz to:		
4.2 GHz	PE15A3276	49 78
2 GHz to:		
2.6 GHz	PE15A63007	52 28
	PE15A5074	53 61
4 GHz	PE1520	50 35
	PE15A6015	51 46
	PE15A1001	52 1
	PE15A5038	55 36
	PE15A5038F	55 37
	PE15A4011	53 62
4.4 GHz	PE15A4040	48 23
	PE15A4041	48 24
6 GHz	PE15A4003	48 25
	PE15A4005	48 26
	PE15A4042	48 27
	PE15A4043	48 28
	PE15A3503	48 51
	PE15A3504	48 52
	PE15A3277	49 79
	PE1521	50 36
	PE15A6007	51 47
	PE15A2001	51 52
	PE15A1010	52 2
	PE15A5066	56 71
PE15A5067	56 72	
PE15A5024	56 73	
PE15A5025	56 74	
PE15A5047	55 38	
PE15A5047F	55 39	
8 GHz	PE15A3016	48 29
	PE15A3290	49 80
	PE15A3291	49 81
	PE15A6008	51 48
	PE15A4054	53 63
	PE15A4054F	53 64
12 GHz	PE15A4055	53 65
	PE15A4055F	53 66
	PE15A4051	48 30
	PE15A3265	48 31
	PE15A3022	48 32
	PE15A3301	49 82
18 GHz	PE15A3257	49 83
	PE15A3258	49 84
	PE1524	50 37
	PE15A1030	52 3
	PE15A5068	56 75
	PE15A4056	53 67
20 GHz	PE15A4056F	53 68
	PE15A4057	53 69
	PE15A4057F	53 70
	PE15A4027	48 33
	PE15A4030	48 34
	PE15A3271	49 85
20 GHz	PE15A3270	49 86
	PE15A4058	53 71
	PE15A4058F	53 72
	PE15A3009	48 35
24 GHz	PE15A3038	48 36
2.2 GHz to:		
2.7 GHz	PE15A5022	53 73

Frequency	Model No.	Page C/R
2.3 GHz to:		
2.7 GHz	PE15A5018	55 40
2.4 GHz to:		
2.5 GHz	PE15B5000	48 3
2.5 GHz to:		
4 GHz	PE15A5006	55 41
2.6 GHz to:		
3.1 GHz	PE15A63008	52 29
	PE15A63009	52 30
4.2 GHz	PE15A5007	55 42
3 GHz to:		
8 GHz	PE15A1035	52 4
3.1 GHz to:		
3.5 GHz	PE15A4046	48 37
	PE15A1006	52 5
	PE15A63010	52 31
	PE15A63011	52 32
	PE15A5023	55 43
3.5 GHz	PE15A5003	55 44
	PE15A5002	53 74
3.5 GHz to:		
7 GHz	PE15A5008	55 45
	PE15A4012	53 75
4 GHz to:		
8 GHz	PE1522	50 38
	PE15A1002	52 6
4.4 GHz to:		
4.9 GHz	PE15A5079	53 76
	PE15A5080	53 77
5 GHz to:		
9 GHz	PE15A9002	52 7
13 GHz	PE15A1073	52 33
5.5 GHz to:		
9.5 GHz	PE15A5009	55 46
6 GHz to:		
10 GHz	PE15A5069	56 76
	PE15A4044	48 38
	PE15A4045	48 39
	PE15A4001	48 40
	PE15A4004	48 41
	PE15A3506	48 53
	PE15A3505	48 54
	PE15A3292	49 87
	PE15A3293	49 88
	PE15A8006	50 39
	PE15A1032	52 8
	PE15A1072	52 9
PE15A4060	53 78	
PE15A4060F	54 79	
12 GHz	PE15A3018	48 42
	PE15A3019	48 43
	PE15A3017	48 44
	PE15A3020	48 45
	PE15A3295	49 89
	PE15A3294	49 90
	PE15A3302	49 91
	PE15A3259	49 92
	PE15A8007	50 40
	PE1523	50 41
	PE15A6012	51 49
	PE15A2002	51 53
18 GHz	PE15A2004	51 54
	PE15A1071	52 10
	PE15A5070	56 77
	PE15A5050	55 47
	PE15A5050F	55 48
	PE15A5049	55 49
	PE15A5049F	55 50
	PE15A4061F	54 80
	PE15A4061	54 81
	PE15A5048	54 82
	PE15A5048F	54 83
	PE15A4062	54 84
PE15A4062F	54 85	
6.4 GHz to:		
7.1 GHz	PE15A5016	56 78
7 GHz to:		
11 GHz	PE15A1033	52 11
17 GHz	PE15A3273	49 93

Frequency	Model No.	Page C/R
7.2 GHz to:		
7.5 GHz	PE15A5019	56 79
7.5 GHz to:		
11 GHz	PE15A4013	54 86
8 GHz to:		
11 GHz	PE15A4014	54 87
	PE15A4015	54 88
12 GHz	PE15A1027	52 12
	PE15A1026	52 13
	PE15A1003M	52 14
	PE15A1003	52 15
	PE15A1025	52 16
	PE15A5071	56 80
	PE15A5072	56 81
	PE15A5053	55 51
	PE15A5053F	55 52
	PE15A5052	55 53
	PE15A5052F	55 54
	PE15A5051	54 89
PE15A5051F	54 90	
PE15A4008	54 91	
12.4 GHz	PE15A4063F	54 92
	PE15A4063	54 93
8.5 GHz to:		
10.5 GHz	PE15A5044	55 55
11 GHz	PE15A5043	55 56
	PE15A4006	54 94
PE15A4007	54 95	
12 GHz to:		
18 GHz	PE15A4002	48 46
	PE15A3507	48 55
	PE15A3296	49 94
PE15A1004	52 17	
12.4 GHz to:		
26.5 GHz	PE15A3024	48 47
14.4 GHz to:		
15.4 GHz	PE15A5021	54 96
17 GHz to:		
24 GHz	PE15A4028	48 48
27 GHz	PE15A3274	49 95
17.5 GHz to:		
21.5 GHz	PE15A4020	55 57
18 GHz to:		
26.5 GHz	PE15A3303	49 96
	PE15A3260	49 97
	PE15A4064	54 97
	PE15A4064F	54 98
	PE15A4021	54 99
	PE15A5054	54 1
40 GHz	PE15A5054F	54 2
	PE15A3025	48 49
	PE15A3268	49 98
	PE15A3304	49 99
	PE15A3279	49 1
	PE15A3305	49 2
PE15A4065	54 3	
PE15A4065F	54 4	
20 GHz to:		
40 GHz	PE15A3501	50 17
	PE15A3508	50 18
	PE15A3509	50 19
	PE15A3502	50 20
	PE15A3510	50 21
PE15A3511	50 22	
26.5 GHz to:		
40 GHz	PE15A4022	48 50
	PE15A3261	49 3
	PE15A3266	49 4
	PE15A3306	49 5
	PE15A3307	49 6
	PE15A3300	52 18
	PE15A4050	54 5
PE15A4067	54 6	
PE15A4067F	54 7	
29 GHz to:		
36 GHz	PE15A3275	49 7
30 GHz to:		
40 GHz	PE15A4069	54 8
	PE15A4069F	54 9

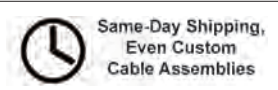

BI-DIRECTIONAL AMPLIFIERS



Amplifiers

Amplifier Type	Frequency Band (GHz.)	Tx Gain (dB)	Gain Var. ±(dB)	P1dB (W)	Rx P1dB (dBm)	Rx NF (dB)	DC Power Tx (V/mA)	ECCN	Model No	1	2-4	5-9	10+	ROW
Bidirectional	30 MHz - 2.7	36	2			2	12/1,400	EAR99	PE15B5003	\$7,128.57	\$6,700.86	\$6,344.43	\$6,059.28	1
Bi-Directional, High Rel	1.35 - 1.39	22	0.5	0.1	20	2.5	28/2,400	EAR99	PE15B5001	\$6,129.41	\$5,884.23	\$5,639.06	\$5,393.88	2
	2.4 - 2.5	20					28/2,400	EAR99	PE15B5000	\$6,491.37	\$6,231.72	\$5,972.06	\$5,712.41	3

BROADBAND AMPLIFIERS



Amplifier Type	Frequency Band (GHz.)	Gain (dB)	Gain Var. ±(dB)	NF (dB)	P1dB (dBm)	Psat (dBm)	DC Power (V/mA)	ECCN	Model No	1	2-4	5-9	10+	ROW
Broadband, High Rel	10 MHz - 6	24	0.75	5	29.5		15/740	EAR99	PE15A4032	\$6,013.21	\$5,772.68	\$5,532.15	\$5,291.62	4
	10 MHz - 15	12	0.3	4.5	28	29	14/360	EAR99	PE15A3036	\$6,643.29	\$6,377.56	\$6,111.83	\$5,846.10	5
	10 MHz - 20	13	0.75	3	23	25	15/225	EAR99	PE15A4029	\$5,186.23	\$4,978.78	\$4,771.33	\$4,563.88	6
Broadband	30 MHz - 40	25	2.5	6	20		11/400	EAR99	PE15A3023	\$8,750.97	\$8,400.93	\$8,050.89	\$7,700.85	7
	100 MHz - 12	18	1	3	25	28	12/300	EAR99	PE15A3007	\$2,321.81	\$2,228.94	\$2,136.07	\$2,043.19	8
	110 MHz - 6	11	1.25	6.5	27	30	12/300	EAR99	PE15A3004	\$2,441.18	\$2,343.53	\$2,245.89	\$2,148.24	9
	110 MHz - 10	10	1.5				12/300	EAR99	PE15A3001	\$2,740.56	\$2,630.94	\$2,521.32	\$2,411.69	10
	300 MHz - 18		37	2		30.5		15/750	EAR99	PE15A3021	\$5,706.59	\$5,478.33	\$5,250.06	\$5,021.80
15/750								EAR99	PE15A3021D	Call	Call	Call	Call	12
Broadband, High Rel	500 MHz - 2	14	0.4	2.7	24		12/180	EAR99	PE15A4038	\$1,042.00	\$1,000.32	\$958.64	\$916.96	13
		30	0.6				12/240	EAR99	PE15A3014	\$1,158.42	\$1,112.08	\$1,065.75	\$1,019.41	14
		46	0.8				12/300	EAR99	PE15A3015	\$1,371.36	\$1,316.51	\$1,261.65	\$1,206.80	15
Broadband	500 MHz - 2.5	24	0.5	3.5	33	33	12/240	EAR99	PE15A4039	\$1,299.17	\$1,247.20	\$1,195.24	\$1,143.27	16
	500 MHz - 6	27	2.5	3			28/600	EAR99	PE15A4037	\$4,445.88	\$4,268.04	\$4,090.21	\$3,912.37	17
500 MHz - 10	32				1	25	12/375	EAR99	PE15A3005	\$2,747.12	\$2,637.24	\$2,527.35	\$2,417.47	18
	27	2.5	12/330	EAR99	PE15A3008		\$3,214.29	\$3,101.79	\$2,989.29	\$2,892.86	19			
Broadband, High Rel	500 MHz - 18	33	1.5	4	15		12/220	EAR99	PE15A3263	\$2,465.17	\$2,366.56	\$2,267.96	\$2,169.35	20
		20	0.5	25	28	12/750	EAR99	PE15A3264	\$1,571.57	\$1,508.71	\$1,445.84	\$1,382.98	21	
	1 - 18	30	1.5	19	20	12/240	EAR99	PE15A3262	\$2,947.04	\$2,829.16	\$2,711.28	\$2,593.40	22	
		13	0.4	23		12/180	EAR99	PE15A4040	\$1,558.50	\$1,496.16	\$1,433.82	\$1,371.48	23	
	2 - 6	22	0.6	5.4	27		12/420	EAR99	PE15A4041	\$2,237.82	\$2,148.31	\$2,058.79	\$1,969.28	24
		32	1	5	33		15/1,700	EAR99	PE15A4003	\$3,816.94	\$3,664.26	\$3,511.58	\$3,358.91	25
		33	1	5	30		12/1,000	EAR99	PE15A4005	\$3,067.47	\$2,944.77	\$2,822.07	\$2,699.37	26
		36	1.5	6	34		15/2,200	EAR99	PE15A4042	\$3,751.20	\$3,601.15	\$3,451.10	\$3,301.06	27
		44	1	4.5	35		12/4,200	EAR99	PE15A4043	\$4,267.33	\$4,096.64	\$3,925.94	\$3,755.25	28
		33		29.4			8.5/941	EAR99	PE15A3016	\$2,649.52	\$2,543.54	\$2,437.56	\$2,331.58	29
Broadband		12			16		12/65	EAR99	PE15A4051	\$1,631.05	\$1,565.81	\$1,500.57	\$1,435.32	30
Broadband, High Rel	2 - 18	33	1.5	3.5	13		12/180	EAR99	PE15A3265	\$2,532.59	\$2,431.29	\$2,329.98	\$2,228.68	31
Broadband		37			30.5		15/800	EAR99	PE15A3022	\$4,871.87	\$4,677.00	\$4,482.12	\$4,287.25	32
Broadband, High Rel	2 - 20	15	0.75	3	26	28	12/310	EAR99	PE15A4027	\$5,986.82	\$5,747.35	\$5,507.87	\$5,268.40	33
31	15/400	EAR99					PE15A4030	\$3,921.70	\$3,764.83	\$3,607.96	\$3,451.10	34		
Broadband	2 - 24	12	0.4	4	18	18.5	12/260	EAR99	PE15A3009	\$2,122.15	\$2,047.87	\$1,973.60	\$1,909.94	35
Broadband, High Rel	2 - 35	30	0.7	4.5	30		3A001.B.4.C	EAR99	PE15A3038	\$7,183.48	\$6,896.14	\$6,608.80	\$6,321.46	36
	3.1 - 3.5	16	0.6	5	27		12/900	EAR99	PE15A4046	\$2,453.99	\$2,355.83	\$2,257.67	\$2,159.51	37
		28	0.8	5	27		12/400	EAR99	PE15A4044	\$2,084.00	\$2,000.64	\$1,917.28	\$1,833.92	38
		37	1.5	6	33		12/500	EAR99	PE15A4045	\$2,453.99	\$2,355.83	\$2,257.67	\$2,159.51	39
		38	1	5	30		15/2,500	EAR99	PE15A4001	\$3,682.30	\$3,535.01	\$3,387.72	\$3,240.42	40
	6 - 12	30	1	3.5	28		15/1,300	EAR99	PE15A4004	\$3,488.08	\$3,348.56	\$3,209.03	\$3,069.51	41
		30	1.5	30		12/1,300	EAR99	PE15A3018	\$3,102.85	\$2,978.74	\$2,854.62	\$2,730.51	42	
		36		30		18/1,700	EAR99	PE15A3019	\$3,938.64	\$3,781.09	\$3,623.55	\$3,466.00	43	
		42		27		15/800	EAR99	PE15A3017	\$3,338.13	\$3,204.60	\$3,071.08	\$2,937.55	44	
	12 - 18	33	2	5.4	30		12/900	EAR99	PE15A3020	\$3,290.16	\$3,158.55	\$3,026.95	\$2,895.34	45
33		2	6	30		15/2,000	EAR99	PE15A4002	\$3,423.05	\$3,286.13	\$3,149.21	\$3,012.28	46	
Broadband	12.4 - 26.5	35		3	24.5		12/500	EAR99	PE15A3024	\$6,888.40	\$6,612.86	\$6,337.33	\$6,061.79	47
Broadband, High Rel	17 - 24	22			24		12/250	EAR99	PE15A4028	\$3,774.49	\$3,623.51	\$3,472.53	\$3,321.55	48
Broadband	18 - 40	30	2.5	6.5	20		12/350	EAR99	PE15A3025	\$6,555.77	\$6,293.54	\$6,031.31	\$5,769.08	49
	26.5 - 40		2	6		12/350	EAR99	PE15A4022	\$5,556.99	\$5,334.71	\$5,112.43	\$4,890.15	50	
High Gain, High Rel	2 - 6	44	1	5	30		15/1,050	EAR99	PE15A3503	\$3,072.86	\$2,949.95	\$2,827.03	\$2,704.12	51
		47	1.5	6	33		15/1,750	EAR99	PE15A3504	\$3,868.99	\$3,714.23	\$3,559.47	\$3,404.71	52
	6 - 12	48	1	5	30		15/2,500	EAR99	PE15A3506	\$3,966.15	\$3,807.50	\$3,648.86	\$3,490.21	53
		43	2	6	30		15/1,350	EAR99	PE15A3505	\$3,340.84	\$3,207.21	\$3,073.57	\$2,939.94	54
	12 - 18	43	2	6	30		15/2,000	EAR99	PE15A3507	\$3,755.07	\$3,604.87	\$3,454.66	\$3,304.46	55

See Our Website For Current Pricing & Real-Time Stock Availability!

BROADBAND AMPLIFIERS



Amplifier Type	Frequency Band (GHz.)	Gain (dB)	Gain Var. ±(dB)	NF (dB)	P1dB (dBm)	Psat (dBm)	DC Power (V/mA)	ECCN	Model No	1 Pc. Price	See Web for Volume Pricing	ROW
Low Noise	0.01 MHz - 3	16	1.5	4	12		15/47	EAR99	PE15A3308	\$750.24	See Web for Volume Pricing	56
	0.1 MHz - 10	33	6.5	5	13		12/110	EAR99	PE15A3311	\$909.42		57
	0.3 MHz - 6.5	39	4.5		17		12/120	EAR99	PE15A3310	\$909.42		58
	1 MHz - 3	21	1.5	4	22		15/110	EAR99	PE15A3309	\$880.54		59
Low Noise, High Rel	10 MHz - 6	34	1		14.5		12/130	EAR99	PE15A3269	\$562.97		60
	10 MHz - 20	15	0.5	3	22	24	12/195	EAR99	PE15A3272	\$5,388.49		61
30 MHz - 20	2.5		20		15/180	EAR99	PE15A3254	\$3,294.88	62			
Low Noise	100 MHz - 18	14	1.5		16	18	12/80	EAR99	PE15A3255	\$1,399.27		63
		28	2.5				12/160	EAR99	PE15A3256	\$2,719.81		64
Low Noise, High Rel	100 MHz - 26.5	15		5	15		15/200	EAR99	PE15A3267	\$5,179.43		65
Low Noise	100 MHz - 40	25	2	3			15/	EAR99	PE15A3280	Call		66
							15/	EAR99	PE15A3281	Call		67
							15/	EAR99	PE15A3282	Call		68
							15/	EAR99	PE15A3283	Call		69
							15/	EAR99	PE15A3284	Call		70
							15/	EAR99	PE15A3285	Call		71
							15/	EAR99	PE15A3286	Call		72
							15/	EAR99	PE15A3287	Call		73
							15/	EAR99	PE15A3288	Call		74
							15/	EAR99	PE15A3289	Call		75
Low Noise, High Rel	500 MHz - 20	14	1.75		14		15/75	EAR99	PE15A3253	\$2,798.10		76
Low Noise	1 - 20	17	1.25			17	15/	EAR99	PE15A3278	Call		77
Low Noise, High Rel	1.8 - 4.2	26		1.2	15.5	17.5	12/105	EAR99	PE15A3276	\$6,416.96		78
Low Noise	2 - 6	35	1	3		18	15/	EAR99	PE15A3277	Call		79
Low Noise, High Rel	2 - 8	14		2.5	13		12/120	EAR99	PE15A3290	\$1,736.68		80
		30					12/150	EAR99	PE15A3291	\$2,165.28		81
Low Noise	2 - 18	22	2.5	3.2	14		12/100	EAR99	PE15A3301	\$5,446.20		82
		26	2	3			12/150	EAR99	PE15A3257	\$1,801.23		83
		33	1				12/180	EAR99	PE15A3258	\$2,231.46		84
Low Noise, High Rel	2 - 20	13	0.5	2	16	21	12/	EAR99	PE15A3271	\$3,774.49		85
		15			13	15.5	12/78	EAR99	PE15A3270	\$4,451.91		86
		17		2.5	7	12/100	EAR99	PE15A3292	\$2,003.79	87		
	30				12/200	EAR99	PE15A3293	\$2,309.62	88			
	6 - 12	14		3	13	12/100	EAR99	PE15A3295	\$1,945.08	89		
		30		2.5	10	12/200	EAR99	PE15A3294	\$2,523.29	90		
32		1.5	2.3	14	12/150	EAR99	PE15A3302	\$5,314.20	91			
Low Noise	6 - 18	38	2		22		12/280	EAR99	PE15A3259	\$1,605.83		92
		22		2.5	14	12/93	EAR99	PE15A3273	\$3,774.49	93		
Low Noise, High Rel	7 - 17	22			14		12/100	EAR99	PE15A3296	\$1,875.60		94
	12 - 18	18		3.5	13		12/96	EAR99	PE15A3274	\$5,762.10		95
	17 - 27	19		2.75	13.5		12/250	EAR99	PE15A3303	\$5,307.25		96
Low Noise	18 - 26.5	32	2.5	2.3	11		12/150	EAR99	PE15A3260	\$2,055.76		97
		40		2.5	13							98
Low Noise, High Rel	18	2	5.5	10			15/250	3A001.B.4.C	PE15A3268	\$7,581.60		98
Low Noise	18 - 40	18			12		12/200	EAR99	PE15A3304	\$9,041.10		99
		35		4		12	20/	EAR99	PE15A3279	Call		1
		44	4		11		12/250	EAR99	PE15A3305	\$9,982.36	2	
	26.5 - 40	22	1	3.5	13.5			12/125	EAR99	PE15A3261	\$1,989.64	3
		30	2	2	11			12/150	EAR99	PE15A3266	\$5,800.82	4
		35	2.5	2.4	10.5			12/150	EAR99	PE15A3306	\$8,165.82	5
		52	3.5	3.3	12			12/375	EAR99	PE15A3307	\$9,881.63	6
Low Noise, High Rel	29 - 36	20		2.9	11		3/80	EAR99	PE15A3275	\$3,774.49	7	

Amplifiers

See Our Website For Current Pricing & Real-Time Stock Availability!

USB CONTROLLED BROADBAND AMPS.



Amplifier Type	Frequency Band (GHz.)	Gain (dB)	NF (dB)	P1dB (dBm)	Control	ECCN	Model No	1	2-4	5-9	10+	ROW
USB	50 MHz - 18	12	4.5	10	USB	EAR99	PE15A3900	\$3,218.23	\$3,089.50	\$2,960.77	\$2,832.04	8
	50 MHz - 40		5				PE15A3901	\$5,312.91	\$5,100.39	\$4,887.88	\$4,675.36	9

Technical Support (866) 727-8376

Same-Day Shipping, Even Custom Cable Assemblies

BENCH-TOP AMPLIFIERS



Amplifiers

Amplifier Type	Frequency Band (GHz.)	Gain (dB)	Gain Var. ±(dB)	NF (dB)	P1dB (dBm)	DC Power (Optional DC In) (V)	AC Power (V/Cycle)	ECCN	Model No	1	2-4	5-9	10+	ROW
Broadband, High Rel	10 MHz - 15	12	0.3	4	28	16/360		EAR99	PE15A3037	\$6,565.04	\$6,302.44	\$6,039.84	\$5,777.24	10
High Gain, High Rel	1 - 20	60	3	5	10	12/	115/60	EAR99	PE15A3500	\$11,353.64	\$10,899.49	\$10,445.35	\$9,991.20	11
							100/	EAR99	PE15A3512	\$11,444.29	\$10,986.52	\$10,528.75	\$10,070.98	12
							220/	EAR99	PE15A3513	\$12,159.55	\$11,673.17	\$11,186.79	\$10,700.40	13
	100/	EAR99	PE15A3514				\$15,612.29	\$14,987.80	\$14,363.31	\$13,738.82	14			
	220/	EAR99	PE15A3515				\$15,612.29	\$14,987.80	\$14,363.31	\$13,738.82	15			
	120/60	EAR99	PE15A3595				\$16,004.27	\$15,444.12	\$14,883.97	\$14,403.84	16			
	20 - 40	30	2	10	115/60	EAR99	PE15A3501	\$11,894.96	\$11,419.16	\$10,943.36	\$10,467.56	17		
					100/60	EAR99	PE15A3508	\$11,962.16	\$11,483.67	\$11,005.19	\$10,526.70	18		
					220/	EAR99	PE15A3509	\$11,962.16	\$11,483.67	\$11,005.19	\$10,526.70	19		
		115/60	EAR99		PE15A3502	\$14,601.55	\$14,017.49	\$13,433.43	\$12,849.36	20				
		100/	EAR99		PE15A3510	\$14,570.29	\$13,987.48	\$13,404.67	\$12,821.86	21				
		220/	EAR99		PE15A3511	\$14,570.29	\$13,987.48	\$13,404.67	\$12,821.86	22				

GAIN BLOCK AMPLIFIERS



Amplifier Type	Frequency Band (GHz.)	Gain (dB)	Gain Var. ±(dB)	NF (dB)	P1dB (dBm)	IP3 (dBm)	DC Power (V/mA)	ECCN	Model No	1 Pc. Price	See Web for Volume Pricing	ROW
Gain Block	10 MHz - 3	12	10	5.5	10		15/40	EAR99	PE1514	\$468.50	See Web for Volume Pricing	23
		15	2	3	11	12	18/40	EAR99	PE1528	\$153.93		24
		20	14	2.7	13		15/50	EAR99	PE1513	\$464.79		25
	10 MHz - 6	15	0.35	4.5		26	12/50	EAR99	PE15A8001	\$717.47		26
	50 MHz - 1	22	0.75	3.5	12		12/150	EAR99	PE1517	\$516.15		27
	50 MHz - 2						12/150	EAR99	PE1518	\$634.95		28
	50 MHz - 4	26	1	5	22	35	12/120	EAR99	PE15A8000	\$745.45		29
	100 MHz - 3	18	18	6	16		15/120	EAR99	PE1516	\$539.49		30
200 MHz - 2.5	22	1.25	15			15/120	EAR99	PE1525	\$537.84	31		
Gain Block, High Rel	500 MHz - 2	17	0.4	1.8		25	12/70	EAR99	PE15A8004	\$937.80	32	
		50	1.8				12/180	EAR99	PE15A8005	\$1,226.99	33	
Gain Block	1 - 4	26		2.5	15		12/120	EAR99	PE1519	\$1,000.04	34	
	2 - 4	25	0.5	3			12/120	EAR99	PE1520	\$1,039.00	35	
	2 - 6	26		3			12/120	EAR99	PE1521	\$877.23	36	
	2 - 18	23	1	3.5	13		12/150	EAR99	PE1524	\$1,256.64	37	
Gain Block, High Rel	4 - 8	26	0.5	3	15		12/100	EAR99	PE1522	\$948.77	38	
		6 - 12	12	0.4	2.3	10	20	12/80	EAR99	PE15A8006	\$1,371.36	39
Gain Block, High Rel	6 - 18	17	0.6		20		12/160	EAR99	PE15A8007	\$1,912.68	40	
Gain Block		22	1	4.5	13		12/150	EAR99	PE1523	\$1,357.12	41	

DC COUPLED AMPLIFIERS



Amplifier Type	Frequency Band (GHz.)	Gain (dB)	Gain Var. ±(dB)	NF (dB)	P1dB (dBm)	IP3 (dBm)	DC Power (V/mA)	ECCN	Model No	1-4	5-9	10-24	25+	ROW
DC Coupled	DC - 17 MHz	30			14	25	/45	EAR99	PE15A86002	\$609.88	\$579.39	\$548.89	\$524.50	42
	DC - 1.5	14			11		/45	EAR99	PE15A86001	\$880.54	\$836.51	\$792.49	\$757.26	43
	DC - 2	8		16			12/45	EAR99	PE15A86000	\$847.49	\$805.12	\$762.74	\$728.84	44

LIMITING AMPLIFIERS



Amplifier Type	Frequency Band (GHz.)	Gain (dB)	Gain Var. ±(dB)	NF (dB)	Input Power (dBm)	Psat (dBm)	DC Power (V/mA)	ECCN	Model No	1	2-4	5-9	10+	ROW
Limitings, High Rel	1 - 2	60	3	3	-40 to 10	19	13/250	EAR99	PE15A6002	\$2,315.90	\$2,223.26	\$2,130.63	\$2,037.99	45

See Our Website For Current Pricing & Real-Time Stock Availability!

LIMITING AMPLIFIERS



Amplifier Type	Frequency Band (GHz.)	Gain (dB)	Gain Var. ±(dB)	NF (dB)	Input Power (dBm)	Psat (dBm)	DC Power (V/mA)	ECCN	Model No	1	2-4	5-9	10+	ROW
Limitings, High Rel	2 - 4	40		3	-20 to 10	19	15/200	EAR99	PE15A6015	\$2,396.60	\$2,300.74	\$2,204.87	\$2,109.01	46
	2 - 6	80	3	4	-61 to 10	15	13/550	EAR99	PE15A6007	\$2,968.58	\$2,849.84	\$2,731.09	\$2,612.35	47
	2 - 8	40	2	5	-20 to 20	19	13/300	EAR99	PE15A6008	\$2,282.81	\$2,191.50	\$2,100.19	\$2,008.87	48
	6 - 18			4										

LOG AMPLIFIERS



Amplifier Type	Frequency Band (GHz.)	Typ Recovery Time (ns)	Min TSS (dBm)	Log Linearity ± (dB)	Log Range (dBm)	Rise Time (ns)	Log Slope (mV/dB)	ECCN	Model No	1	2-4	5-9	10+	ROW
Log, High Rel	500 MHz - 4	40	-73	2.5	-70 to 0	5	25	EAR99	PE15A2000	\$14,466.76	\$13,888.09	\$13,309.42	\$12,730.75	50
	500 MHz - 18	150	-65		-65 to 5	20	20	EAR99	PE15A2003	\$16,799.48	\$16,127.50	\$15,455.52	\$14,783.54	51
	2 - 6	60	-73	2.5	-70 to 5	15	40	EAR99	PE15A2001	\$10,530.95	\$10,109.71	\$9,688.47	\$9,267.24	52
		70	-72		50	25	EAR99	PE15A2002	\$14,466.76	\$13,888.09	\$13,309.42	\$12,730.75	53	
	6 - 18	150	-40	1	-40 to 0	20	50	EAR99	PE15A2004	\$6,752.97	\$6,482.85	\$6,212.73	\$5,942.61	54

LOW NOISE AMPLIFIERS

Standard



Amplifier Type	Frequency Band (GHz.)	Gain (dB)	Gain Var. ±(dB)	NF (dB)	P1dB (dBm)	IP3 (dBm)	DC Power (V/mA)	ECCN	Model No	1 Pc. Price	See Web for Volume Pricing	ROW
Low Noise	0.009 MHz - 3	32	1.25	2.5	16	29	15/110	EAR99	PE15A1007	\$437.21	See Web for Volume Pricing	55
		0.01 MHz - 500 MHz	45		0.5	11	23	16/75	EAR99	PE15A1046		\$688.24
	0.01 MHz - 1.4	42	1	3	19	32	16/120	EAR99	PE15A1055	\$800.39		57
	0.01 MHz - 2	28	2	3.2	13	23	18/45	EAR99	PE15A1059	\$579.98		58
	0.03 MHz - 600 MHz	50	1.2	2.2	14	24	18/85	EAR99	PE15A1047	\$869.98		59
	1 MHz - 500 MHz	33.5	1.5	2	13		30/40	EAR99	PE15A1045	\$579.98		60
	10 MHz - 250 MHz	17	0.5	1.4	22	39	5.25/160	EAR99	PE15A1043	\$800.39		61
	10 MHz - 550 MHz	29.7	0.3	1.7	19	34	15/105	EAR99	PE15A1044	\$726.93		62
	10 MHz - 600 MHz	40.5	0.8	0.9		15/140	EAR99	PE15A1063	\$1,163.84	63		
	10 MHz - 800 MHz	42	0.7	2	17	30	15/100	EAR99	PE15A1048	\$699.64		64
		60	1.5	2.1		27	15/160	EAR99	PE15A1065	\$1,299.17		65
	High Gain	10 MHz - 1	30	0.7	1	15/110	EAR99	PE15A1011	\$435.43	66		
			32	2	12	23	15/40	EAR99	PE15A1049	\$524.72		67
			40	1	0.8	17	31.5	15/110	EAR99	PE15A1012		\$460.21
50			1.25	1	18	28	15/140	EAR99	PE15A1013	\$545.11	69	
Low Noise	10 MHz - 1.3	51	0.8	2.2	13	22	15/88	EAR99	PE15A1052	\$800.39	70	
		35	0.5	1.5	20	34	15/165	EAR99	PE15A1054	\$947.31	71	
	10 MHz - 3	34	0.75	1.4	11	25	15/95	EAR99	PE15A1009	\$706.31	72	
	20 MHz - 1	30	0.5	1.3	18	32	18/140	EAR99	PE15A1051	\$770.35	73	
		30.5	0.8		19	34	15/140	EAR99	PE15A1064	\$1,163.84	74	
	20 MHz - 1.5	20	1.2	1	17	35	18/70	EAR99	PE15A1057	\$688.24	75	
	20 MHz - 3	25	0.75	1.6	13.5	25	15/75	EAR99	PE15A1008	\$565.00	76	
	20 MHz - 4		0.7	2	18	34	5.5/160	EAR99	PE15A1061	\$982.10	77	
40 MHz - 3	16	1.6	1.3	7	22	3.3/18	EAR99	PE15A1060	\$699.64	78		
Linear Low Noise	50 MHz - 1	15	0.7	1.5	23	37	12/85	EAR99	PE15A9001	\$345.62	79	
		18	0.5	1	16	32	18/70	EAR99	PE15A1050	\$662.41	80	
Low Noise	50 MHz - 1	19			18	36	12/90	EAR99	PE15A1014	\$289.88	81	
		47	1	2.2	13	23	15/88	EAR99	PE15A1053	\$800.39	82	
	50 MHz - 2	27	0.75	1.8	22	37	13.5/160	EAR99	PE15A1042	\$663.79	83	
	100 MHz - 2	61.5	1	2.5	19	33	15/170	EAR99	PE15A1066	\$1,419.02	84	
	500 MHz - 3	14.5	0.4	2	20	35	12/90	EAR99	PE15A1017	\$339.09	85	
		29	1	2.6		12/190	EAR99	PE15A1018	\$429.12	86		
	500 MHz - 4	24	2.5	0.7	17	34	15/65	EAR99	PE15A1068	\$800.39	87	
700 MHz - 2.7	23	18			35	15/65	EAR99	PE15A1067	\$800.39	88		
Low Noise, High Rel	1 - 2	35	1	1.5	10		13/200	EAR99	PE15A1000	\$1,274.41	89	

Amplifiers

See Our Website For Current Pricing & Real-Time Stock Availability!

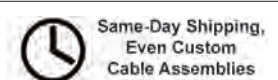

Standard



Amplifiers

Amplifier Type	Frequency Band (GHz.)	Gain (dB)	Gain Var. ±(dB)	NF (dB)	P1dB (dBm)	IP3 (dBm)	DC Power (V/mA)	ECCN	Model No	1 Pc. Price	See Web for Volume Pricing	ROW
High Gain	1 - 2	40	1	0.8	11	25	12/120	EAR99	PE15A1019	\$973.08	See Web for Volume Pricing	90
Low Noise	1 - 4	20	1.2		20	41	15/120	EAR99	PE15A1070	\$800.39		91
Low Noise, High Rel	1 - 12	16	0.75	1.5	17	10	6/60	EAR99	PE15A1031	\$5,345.66		92
		25			13.2/150		EAR99	PE15A1023	\$614.05	93		
		35			13.2/180		EAR99	PE15A1024	\$688.46	94		
High Gain, High Rel	1.2 - 1.4	40	0.5	0.8	12	15	13.2/200	EAR99	PE15A1005	\$1,146.33		95
Low Noise		15/100			EAR99		PE15A1028	\$649.58	96			
Integrated Band Pass Filter Low Noise	1.215 - 1.4	25	0.75	0.5	16	16	12/130	EAR99	PE15A1039	\$973.83		97
		35					12/130	EAR99	PE15A1040	\$902.19		98
Low Phase Noise, High Rel	1.5 - 5	14		4.5	17	27	9/170	EAR99	PE15A1034	\$5,923.34		99
Low Noise, High Rel	2 - 4	38	1	2	13		13/200	EAR99	PE15A1001	\$1,543.07		1
High Gain	2 - 6	40		0.9	14	25	15/90	EAR99	PE15A1010	\$1,039.46		2
Low Phase Noise, High Rel	2 - 18	12.5		6.5	13		5/80	EAR99	PE15A1030	\$9,855.78		3
	3 - 8	11		6	14	25	7/250	EAR99	PE15A1035	\$5,923.34		4
High Gain, High Rel	3.1 - 3.5	40	0.3	1.1	15		17/150	EAR99	PE15A1006	\$1,776.25		5
Low Noise, High Rel	4 - 8	38	1	2	13		13/250	EAR99	PE15A1002	\$1,667.45		6
	5 - 9	22.5		1.75	14.8	25	12/105	EAR99	PE15A9002	\$6,942.42		7
Low Phase Noise, High Rel	6 - 12	11	1	4.5	20	34	7/200	EAR99	PE15A1032	\$6,154.35		8
		25		0.7	2.1	11	25	5.5/65	EAR99	PE15A1072	\$1,562.11	9
Low Noise	6 - 18	26	2.5	1.9					5.5/65	EAR99	PE15A1071	\$1,635.55
Low Phase Noise, High Rel	7 - 11	9		6	22	33	7/300	EAR99	PE15A1033	\$6,910.58	11	
Low Noise, High Rel	8 - 12	18	1	2.2	13		13/150	EAR99	PE15A1027	\$1,623.96	12	
		28					13/200	EAR99	PE15A1026	\$1,803.68	13	
		38					13/250	EAR99	PE15A1003M	\$2,003.59	14	
		48					13/250	EAR99	PE15A1003	\$1,928.82	15	
		38					13/300	EAR99	PE15A1025	\$2,236.74	16	
		38					13/300	EAR99	PE15A1004	\$2,194.81	17	
Low Noise	26.5 - 40	43	2	2	12	20	15/110	EAR99	PE15A3300	\$3,220.47	18	

Input Protected



See Our Website For Current Pricing & Real-Time Stock Availability!

Amplifier Type	Frequency Band (GHz.)	Gain (dB)	Gain Var. ±(dB)	NF (dB)	P1dB (dBm)	IP3 (dBm)	DC Power (V/mA)	ECCN	Model No	1-4	5-9	10-24	25+	ROW
Input Protected Low Noise	10 MHz - 1	30	0.7	1	17	32	15/120	EAR99	PE15A63000	\$680.00	\$646.00	\$612.00	\$584.80	19
		40	1			31.5	15/110	EAR99	PE15A63001	\$680.00	\$646.00	\$612.00	\$584.80	20
	30 MHz - 1.5	25	0.5	1.6	22	39	15/150	EAR99	PE15A63002	\$635.51	\$603.73	\$571.96	\$546.54	21
		29			23		15/160	EAR99	PE15A63003	\$635.51	\$603.73	\$571.96	\$546.54	22
	900 MHz - 1.2	30	1	1.2	10		12/100	EAR99	PE15A63004	\$595.45	\$565.68	\$535.91	\$512.09	23
		40					12/100	EAR99	PE15A63005	\$595.45	\$565.68	\$535.91	\$512.09	24
1 - 1.4	30						12/110	EAR99	PE15A63006	\$595.45	\$565.68	\$535.91	\$512.09	25
Input Protected GaN Low Noise	1 - 7	42	4	1.6	21	30		EAR99	PE15A1075	Call	Call	Call	Call	26
	1 - 23	29	1.5	4	23	32		EAR99	PE15A1074	Call	Call	Call	Call	27
Input Protected Low Noise	2 - 2.6	30	0.35	0.85	12		15/110	EAR99	PE15A63007	\$929.56	\$883.08	\$836.60	\$799.42	28
			1	1.2	10		12/120	EAR99	PE15A63008	\$920.79	\$874.75	\$828.71	\$791.88	29
	2.6 - 3.1	40					12/120	EAR99	PE15A63009	\$844.02	\$801.82	\$759.62	\$725.86	30
		28	0.5	0.8	8	20	15/45	EAR99	PE15A63010	\$844.02	\$801.82	\$759.62	\$725.86	31
3.1 - 3.5	35	1	0.85	13			12/100	EAR99	PE15A63011	\$876.94	\$833.09	\$789.25	\$754.17	32
Input Protected GaN Low Noise	5 - 13	46	1.5	1.8	21	30		EAR99	PE15A1073	Call	Call	Call	Call	33

POWER AMPLIFIERS (<4W)



Amplifier Type	Frequency Band (GHz.)	Gain (dB)	Gain Var. ±(dB)	NF (dB)	P1dB (dBm)	Psat (dBm)	DC Power (V/ma)	ECCN	Model No	1 Pc. Price	See Web for Volume Pricing	ROW	
High Power, Class AB	1 MHz - 1	36	1.5		33	36	28/1,200	EAR99	PE15A5030	\$2,953.73		34	
High Power, Class AB, Power with Fan							28/1,700	EAR99	PE15A5030F	\$3,710.72		35	
High Power, Class AB	1.5 MHz - 30 MHz 1.5 MHz - 100 MHz 20 MHz - 520 MHz	47	2			47	28/5,000	EAR99	PE15A5055	\$5,120.00		36	
							28/5,000	EAR99	PE15A5056	\$6,600.00		37	
							28/9,000	EAR99	PE15A5065	\$6,106.67		38	
Power	20 MHz - 1	40	0.5	6	36		24/630	EAR99	PE15A4072	\$2,071.44		39	
High Power, Class AB		49	2			49	28/11,000	EAR99	PE15A5057	\$7,586.67		40	
Power	20 MHz - 3	27	0.75	5		30	12/220	EAR99	PE15A4017	\$779.59		41	
	30 MHz - 3	38	1				12/270	EAR99	PE15A4018	\$899.55		42	
	50 MHz - 1	26	0.75				28	12/450	EAR99	PE15A4009		\$1,199.24	43
	60 MHz - 6	36	1.5				15/530	EAR99	PE15A4019	\$2,600.82		44	
High Rel	100 MHz - 18	25	3	8	29		15/1,000	EAR99	PE15A4052	\$10,238.16		45	
High Rel, Power with Fan							15/2,160	EAR99	PE15A4052F	Call		46	
Power, Class AB	200 MHz - 2.6	46	4		33	10	28/1,400	EAR99	PE15A5084	\$4,791.75		47	
High Power, Class AB	500 MHz - 1	50	2			50	28/10,000	EAR99	PE15A5058	\$6,600.00		48	
High Rel	500 MHz - 4	30	3	6	30		12/1,500	EAR99	PE15A4053	\$3,890.28		49	
High Rel, Power with Fan							12/2,660	EAR99	PE15A4053F	\$4,840.32		50	
High Power, Class AB	800 MHz - 1	53	2			53	28/25,000	EAR99	PE15A5061	\$6,600.00		51	
Power, Class AB	800 MHz - 2	55	2.5			31	40	28/3,000	EAR99	PE15A5077	\$4,753.45		52
Power, Class AB, Power with Fan		31	2	30.8	31.8	13/1,000	EAR99	PE15A5034F	\$2,488.33		53		
Power, Class AB	800 MHz - 4.2	31	2				13/800	EAR99	PE15A5034	\$1,870.01	See Web for Volume Pricing	54	
Power	820 MHz - 960 MHz	15	0.5	2	30		12/500	EAR99	PE15A4026	\$523.84		55	
							12/600	EAR99	PE15A4025	\$1,321.61		56	
High Power	1 - 2	35	0.75	1.5	33		12/800	EAR99	PE15A4016	\$1,543.77		57	
Power, Class AB	1 - 2.5	14	3			20	28/2,200	EAR99	PE15A5085	\$4,604.15		58	
		45	4	33	7	28/650	EAR99	PE15A5083	\$4,032.41	59			
Power	1.2 - 1.4	46	0.5	2		28	12/400	EAR99	PE15A4010	\$1,655.81		60	
Power, Class AB	2 - 2.6	54	2.5		31	30	28/2,400	EAR99	PE15A5074	\$4,727.48		61	
High Power	2 - 4.4	32	0.5	10	36	37		EAR99	PE15A4011	\$2,399.52		62	
High Rel	2 - 8	38	2.5	5.5	30		12/1,200	EAR99	PE15A4054	\$5,574.70		63	
High Rel, Power with Fan							12/2,360	EAR99	PE15A4054F	\$6,726.67		64	
High Rel	2 - 12	35	4		33		15/4,500	EAR99	PE15A4055	\$12,935.70		65	
High Rel, Power with Fan							15/5,660	EAR99	PE15A4055F	\$14,868.75		66	
High Rel	2 - 18		2.5		30		12/2,500	EAR99	PE15A4056	\$11,722.50		67	
High Rel, Power with Fan							12/3,660	EAR99	PE15A4056F	\$12,626.67		68	
Power	2 - 20	30	4		33		12/5,000	EAR99	PE15A4057	\$13,537.08		69	
Power with Fan							12/6,160	EAR99	PE15A4057F	\$14,588.24		70	
High Rel	2 - 20		5.5		31		12/4,500	EAR99	PE15A4058	\$13,073.64		71	
High Rel, Power with Fan							12/5,660	EAR99	PE15A4058F	\$13,923.33		72	
High Power	2.2 - 2.7	50	1.5			49	28/11,000	EAR99	PE15A5022	\$13,791.18		73	
	3.1 - 3.5	45	2	4		40	15/5,000	EAR99	PE15A5002	\$3,025.04		74	
	3.5 - 7	26	2	11	36	37	1/1,600	EAR99	PE15A4012	\$2,971.54		75	
Power, Class AB, Power with Fan	4.4 - 4.9	48	5		33	20	28/3,600	5A991.G	PE15A5079	\$7,853.42		76	
							28/3,600	5A991.G	PE15A5080	\$8,853.42		77	
High Rel	6 - 12	47	2.5	6.5	30.5		12/1,500	EAR99	PE15A4060	\$4,869.61		78	

Amplifiers

See Our Website For Current Pricing & Real-Time Stock Availability!

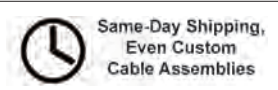
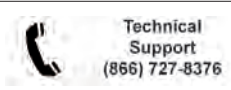

POWER AMPLIFIERS (<4W)



Amplifiers

Amplifier Type	Frequency Band (GHz.)	Gain (dB)	Gain Var. ±(dB)	NF (dB)	P1dB (dBm)	Psat (dBm)	DC Power (V/mA)	ECCN	Model No	1	2-4	5-9	10+	ROW
High Rel, Power with Fan	6 - 12	47	2.5	6.5	30.5		12/2,660	EAR99	PE15A4060F	\$5,854.84	\$5,620.65	\$5,386.45	\$5,152.26	79
		30		7	27		12/1,380	EAR99	PE15A4061F	\$6,421.88	\$6,165.00	\$5,908.13	\$5,651.25	80
High Rel	6 - 18	35	3.5	10	30		12/800	EAR99	PE15A4061	\$5,597.24	\$5,373.35	\$5,149.46	\$4,925.57	81
							12/2,500	EAR99	PE15A5048	\$10,821.91	\$10,389.03	\$9,956.16	\$9,523.28	82
High Rel, Power with Fan	6 - 18	38	3.5	10	30		12/3,660	EAR99	PE15A5048F	\$11,905.88	\$11,429.64	\$10,953.41	\$10,477.17	83
High Rel							12/1,800	EAR99	PE15A4062	\$9,767.01	\$9,376.33	\$8,985.65	\$8,594.97	84
High Rel, Power with Fan	6 - 18	38	3.5	10	30		12/2,960	EAR99	PE15A4062F	\$10,750.00	\$10,320.00	\$9,890.00	\$9,460.00	85
High Power							7.5 - 11	25	2	33	37	EAR99	PE15A4013	\$2,401.25
Power	8 - 11	28	3	32	36		12/3,000	EAR99	PE15A4014	\$2,053.40	\$1,971.26	\$1,889.13	\$1,806.99	87
High Power							12/2,500	EAR99	PE15A4015	\$2,052.41	\$1,970.31	\$1,888.22	\$1,806.12	88
High Rel	8 - 12	30	2	33			12/2,500	EAR99	PE15A5051	\$6,698.57	\$6,430.63	\$6,162.68	\$5,894.74	89
High Rel, Power with Fan							12/3,660	EAR99	PE15A5051F	\$7,832.35	\$7,519.06	\$7,205.76	\$6,892.47	90
Power	8 - 12	41	1	3.5	30	31	12/1,200	EAR99	PE15A4008	\$3,144.35	\$3,018.58	\$2,892.80	\$2,767.03	91
High Rel, Power with Fan							8 - 12.4	30	1.75	6	27		12/1,380	EAR99
High Rel	12/800	EAR99	PE15A4063	\$4,091.60	\$3,927.94	\$3,764.27							\$3,600.61	93
Power	8.5 - 11	43	0.5	3	30		15/900	EAR99	PE15A4006	\$2,787.03	\$2,675.55	\$2,564.07	\$2,452.59	94
							0.75	5	36	12/4,500	EAR99	PE15A4007	\$3,823.22	\$3,670.29
High Rel	14.4 - 15.4	43	0.5	34.8			15/1,500	EAR99	PE15A5021	\$7,815.00	\$7,502.40	\$7,189.80	\$6,877.20	96
							12/1,150	EAR99	PE15A4064	\$9,510.00	\$9,129.60	\$8,749.20	\$8,368.80	97
High Rel, Power with Fan	18 - 26.5	28	2.5	7	27		12/1,730	EAR99	PE15A4064F	\$10,043.33	\$9,641.60	\$9,239.86	\$8,838.13	98
Power							12/1,800	EAR99	PE15A4021	\$4,233.28	\$4,063.95	\$3,894.62	\$3,725.29	99
High Rel	18 - 26.5	33	1.25	5	31		12/3,500	EAR99	PE15A5054	\$12,042.04	\$11,560.36	\$11,078.68	\$10,597.00	1
High Rel, Power with Fan							12/4,660	EAR99	PE15A5054F	\$12,664.71	\$12,158.12	\$11,651.53	\$11,144.94	2
High Rel	18 - 40	35	4	9	23		12/1,000	EAR99	PE15A4065	\$11,107.87	\$10,663.56	\$10,219.24	\$9,774.93	3
High Rel, Power with Fan							12/1,580	EAR99	PE15A4065F	\$11,509.68	\$11,049.29	\$10,588.91	\$10,128.52	4
Power	26.5 - 40	3	4.5	20	22		12/270	EAR99	PE15A4050	\$3,067.12	\$2,944.44	\$2,821.75	\$2,699.07	5
High Rel							12/3,000	EAR99	PE15A4067	\$12,632.25	\$12,190.12	\$11,747.99	\$11,369.03	6
High Rel, Power with Fan	26.5 - 40	4	10		27		12/3,160	EAR99	PE15A4067F	\$13,894.59	\$13,408.28	\$12,921.97	\$12,505.13	7
High Rel							12/350	EAR99	PE15A4069	\$8,068.55	\$7,745.81	\$7,423.07	\$7,100.32	8
High Rel, Power with Fan	30 - 40	20	2		20		12/930	EAR99	PE15A4069F	\$8,660.00	\$8,313.60	\$7,967.20	\$7,620.80	9

HIGH POWER AMPLIFIERS (>4W)



See Our Website For Current Pricing & Real-Time Stock Availability!

Amplifier Type	Frequency Band (GHz.)	Gain (dB)	Gain Var. ±(dB)	NF (dB)	P1dB (dBm)	Psat (dBm)	DC Power (V/mA)	ECCN	Model No	1	2-4	5-9	10+	ROW
High Power, Class AB	0.15 MHz - 230 MHz	43	1.5	41.8	44		28/5,000	EAR99	PE15A5028	\$3,815.44	\$3,662.82	\$3,510.20	\$3,357.59	10
							28/5,500	EAR99	PE15A5028F	\$4,740.57	\$4,550.95	\$4,361.32	\$4,171.70	11
							28/2,000	EAR99	PE15A5029	\$2,477.19	\$2,378.10	\$2,279.01	\$2,179.93	12
High Power, Class AB, Power with Fan	0.5 MHz - 500 MHz	44	1.5	40	39		28/2,000	EAR99	PE15A5029F	\$2,638.33	\$2,532.80	\$2,427.26	\$2,321.73	13
High Power, Class AB							20 MHz - 1	46	44		28/5,200	EAR99	PE15A5031	\$3,908.32
High Power, Class AB, Power with Fan	28/5,800	EAR99	PE15A5031F	\$4,653.07	\$4,466.95	\$4,280.82					\$4,094.70	15		
High Power	500 MHz - 2.8	37	2	10	37		12/1,800	EAR99	PE15A5013	\$4,505.69	\$4,325.46	\$4,145.23	\$3,965.01	16
							700 MHz - 2.2	EAR99	PE15A5004	\$2,376.28	\$2,293.11	\$2,209.94	\$2,138.65	17
							800 MHz - 960 MHz	30	1	3	38		12/1,800	EAR99
		37					12/1,800	EAR99	PE15A5041	\$1,399.86	\$1,343.87	\$1,287.87	\$1,231.88	19

HIGH POWER AMPLIFIERS (>4W)



Amplifier Type	Frequency Band (GHz.)	Gain (dB)	Gain Var. ±(dB)	NF (dB)	P1dB (dBm)	Psat (dBm)	DC Power (V/mA)	ECCN	Model No	1	2-4	5-9	10+	ROW	
High Power, Class AB	800 MHz - 2	41	1.5		40	40.8	13/5,000	EAR99	PE15A5035	\$4,585.85	\$4,402.42	\$4,218.98	\$4,035.55	20	
							13/5,500	EAR99	PE15A5035F	\$4,799.69	\$4,607.70	\$4,415.71	\$4,223.73	21	
High Power, Class A	800 MHz - 2.5	40	2		41		12/5,500	EAR99	PE15A5020	\$4,906.27	\$4,710.02	\$4,513.77	\$4,317.52	22	
High Power	860 MHz - 960 MHz	42	1	3.5			12/2,800	EAR99	PE15A5042	\$2,847.79	\$2,733.88	\$2,619.97	\$2,506.06	23	
							12/6,500	EAR99	PE15A5039	\$4,063.80	\$3,901.25	\$3,738.70	\$3,576.14	24	
High Power, Class AB, Power with Fan	1 - 2.5	40	1.5		39	40	13/5,500	EAR99	PE15A5036F	\$5,207.92	\$4,999.60	\$4,791.29	\$4,582.97	25	
High Power, Class AB		44		41		13/5,000	EAR99	PE15A5036	\$4,282.92	\$4,111.60	\$3,940.29	\$3,768.97	26		
Power, Class AB, Power with Fan		47	3		38	18	28/1,900	EAR99	PE15A5082	\$6,607.04	\$6,210.62	\$5,880.27	\$5,615.98	27	
Power, Class AB		50		28/1,900			EAR99	PE15A5081	\$5,607.04	\$5,270.62	\$4,990.27	\$4,765.98	28		
High Power, Class AB	1 - 3	44	1.5		37.8	39	13/3,000	EAR99	PE15A5037	\$5,359.06	\$5,144.70	\$4,930.34	\$4,715.97	29	
High Power, Class AB, Power with Fan							13/4,000	EAR99	PE15A5037F	\$6,363.88	\$6,109.32	\$5,854.77	\$5,600.21	30	
High Power	1.2 - 1.4	40	0.3	10	40		12/4,000	EAR99	PE15A5001	\$4,135.53	\$3,970.11	\$3,804.69	\$3,639.27	31	
	1.5 - 3.5	20	1.25		38.5	39		EAR99	PE15A5005	\$2,522.03	\$2,421.15	\$2,320.27	\$2,219.39	32	
	1.7 - 2	50	0.5		43			EAR99	PE15A5014	\$4,290.60	\$4,118.98	\$3,947.35	\$3,775.73	33	
Power, Class AB	1.7 - 2.4	54	3		42	35	28/3,600	EAR99	PE15A5073	\$4,617.41	\$4,340.37	\$4,109.49	\$3,924.80	34	
High Power	1.7 - 2.5	11	0.5		37		12/800	EAR99	PE15A5015	\$2,531.47	\$2,430.21	\$2,328.95	\$2,227.69	35	
Power, Class AB	2 - 4	39	1.5		37.8	39	13/3,000	EAR99	PE15A5038	\$5,543.44	\$5,321.70	\$5,099.96	\$4,878.23	36	
							13/5,500	EAR99	PE15A5038F	\$6,038.39	\$5,796.85	\$5,555.32	\$5,313.78	37	
High Rel	2 - 6	40	3.5		37		12/7,000	EAR99	PE15A5047	\$11,298.27	\$10,846.34	\$10,394.41	\$9,942.48	38	
High Rel, Power with Fan							12/8,160	EAR99	PE15A5047F	\$12,376.47	\$11,881.41	\$11,386.35	\$10,891.29	39	
High Power	2.3 - 2.7	55	0.5		41.5		12/5,500	EAR99	PE15A5018	\$5,818.40	\$5,585.66	\$5,352.93	\$5,120.19	40	
	2.5 - 4	19	1	8	38	38.5		EAR99	PE15A5006	\$1,607.67	\$1,543.36	\$1,479.06	\$1,414.75	41	
	2.6 - 4.2			9	39	39		EAR99	PE15A5007	\$1,670.37	\$1,603.56	\$1,536.74	\$1,469.93	42	
	3.1 - 3.5	8	0.5		37			12/750	EAR99	PE15A5023	\$2,896.15	\$2,780.30	\$2,664.46	\$2,548.61	43
		47	1.5	3.5	43			12/9,000	EAR99	PE15A5003	\$4,135.53	\$3,970.11	\$3,804.69	\$3,639.27	44
	3.5 - 7	19	2	12	37	38			EAR99	PE15A5008	\$2,971.54	\$2,852.68	\$2,733.82	\$2,614.96	45
24		8.5					EAR99	PE15A5009	\$2,940.58	\$2,822.96	\$2,705.33	\$2,587.71	46		
High Rel	6 - 18	40	5		40		12/13,000	EAR99	PE15A5050	\$20,395.29	\$19,681.45	\$18,967.62	\$18,355.76	47	
High Rel, Power with Fan							15/14,160	EAR99	PE15A5050F	\$22,748.00	\$21,951.82	\$21,155.64	\$20,473.20	48	
High Rel							12/7,500	EAR99	PE15A5049	\$17,182.03	\$16,580.66	\$15,979.29	\$15,463.83	49	
High Rel, Power with Fan							12/8,660	EAR99	PE15A5049F	\$18,552.78	\$17,903.43	\$17,254.09	\$16,697.50	50	
High Rel							12/14,000	EAR99	PE15A5053	\$17,036.70	\$16,440.42	\$15,844.13	\$15,333.03	51	
High Rel, Power with Fan							12/15,160	EAR99	PE15A5053F	\$18,112.50	\$17,478.56	\$16,844.63	\$16,301.25	52	
High Rel	8 - 12	30	2.5		40		12/6,000	EAR99	PE15A5052	\$12,634.99	\$12,129.59	\$11,624.19	\$11,118.79	53	
High Rel, Power with Fan							12/7,160	EAR99	PE15A5052F	Call	Call	Call	Call	54	
High Power	8.5 - 10.5	36	1.5	5	38.5		12/4,000	EAR99	PE15A5044	\$4,619.27	\$4,434.50	\$4,249.73	\$4,064.96	55	
	8.5 - 11	30	0.75				12/7,500	EAR99	PE15A5043	\$4,258.37	\$4,088.04	\$3,917.70	\$3,747.37	56	
	17.5 - 21.5	40	1.5				12/3,500	EAR99	PE15A4020	\$4,566.31	\$4,383.66	\$4,201.01	\$4,018.35	57	

Amplifiers

See Our Website For Current Pricing & Real-Time Stock Availability!

GaN HIGH POWER



Amplifier Type	Frequency Band (GHz.)	Gain (dB)	Gain Var. ±(dB)	NF (dB)	P1dB (dBm)	Psat (dBm)	DC Power (V/mA)	ECCN	Model No	1	2-4	5-9	10+	ROW
High Power	30 MHz - 2.5	43	2			40	12/2,800	EAR99	PE15A5011	\$7,728.39	\$7,419.25	\$7,110.12	\$6,800.98	58

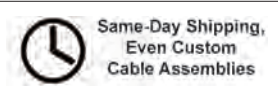

GaN HIGH POWER



Amplifiers

Amplifier Type	Frequency Band (GHz.)	Gain (dB)	Gain Var. ±(dB)	NF (dB)	P1dB (dBm)	Psat (dBm)	DC Power (V/mA)	ECCN	Model No	1	2-4	5-9	10+	ROW		
High Power	100 MHz - 6	60	1.25	10		40	28/2,200	EAR99	PE15A5027	\$18,517.08	\$17,776.40	\$17,035.71	\$16,295.03	59		
High Power, Class AB	500 MHz - 2.5	48	2	44	47	28/7,000	28/7,000	EAR99	PE15A5059	\$5,426.67	\$5,101.07	\$4,829.74	\$4,612.67	60		
		50				28/13,000	28/13,000	EAR99	PE15A5060	\$12,596.67	\$11,840.87	\$11,211.04	\$10,707.17	61		
						36/8,333	36/8,333	EAR99	PE15A5032	\$15,550.00	\$14,928.00	\$14,306.00	\$13,684.00	62		
High Power, Class AB, Power with Fan	500 MHz - 3	48			47	36/8,333	36/8,333	EAR99	PE15A5032F	\$15,850.00	\$15,216.00	\$14,582.00	\$13,948.00	63		
High Power, Class AB	700 MHz - 2.7	45	1.5	50	30/8,733	30/8,733	30/8,733	EAR99	PE15A5033	\$14,518.19	\$13,937.46	\$13,356.73	\$12,776.01	64		
High Power, Class AB, Power with Fan								EAR99	PE15A5033F	\$14,965.71	\$14,367.08	\$13,768.45	\$13,169.82	65		
High Power	700 MHz - 6	43	2	40	32/2,000	32/2,000	32/2,000	EAR99	PE15A5017	\$9,536.11	\$9,154.67	\$8,773.22	\$8,391.78	66		
High Power, Class AB	800 MHz - 4.2	47						28/13,000	28/13,000	EAR99	PE15A5062	\$8,253.33	\$7,758.13	\$7,345.46	\$7,015.33	67
High Power, Class AB	1 - 2	53	1.5	53	28/20,000	28/20,000	28/20,000	EAR99	PE15A5063	\$10,056.67	\$9,453.27	\$8,950.44	\$8,548.17	68		
		50	1.25					10	28/4,000	28/4,000	EAR99	PE15A5026	\$18,367.34	\$17,632.65	\$16,897.95	\$16,163.26
High Power, Class AB	1.2 - 1.6	48	2.5	43	28/8,000	28/8,000	28/8,000	EAR99	PE15A5064	\$4,696.67	\$4,414.87	\$4,180.04	\$3,992.17	70		
		43	2					28/5,000	28/5,000	EAR99	PE15A5066	\$8,250.00	\$7,755.00	\$7,342.50	\$7,012.50	71
		46	2					28/6,000	28/6,000	EAR99	PE15A5067	\$13,723.33	\$12,899.93	\$12,213.76	\$11,664.83	72
High Power	2 - 6	50	1.25	7	44	28/3,000	28/3,000	EAR99	PE15A5024	\$15,110.08	\$14,581.23	\$14,052.37	\$13,599.07	73		
								47	28/6,000	28/6,000	EAR99	PE15A5025	\$18,958.61	\$18,200.27	\$17,441.92	\$16,683.58
High Power, Class AB	2 - 18	37	3.5	37	22/2,500	22/2,500	22/2,500	EAR99	PE15A5068	\$17,050.00	\$16,027.00	\$15,174.50	\$14,492.50	75		
		43	2					24/7,000	24/7,000	EAR99	PE15A5069	\$15,976.67	\$15,018.07	\$14,219.24	\$13,580.17	76
		40	3					28/3,000	28/3,000	EAR99	PE15A5070	\$14,300.00	\$13,442.00	\$12,727.00	\$12,155.00	77
High Power	6.4 - 7.1	58	2	43	33/2,300	33/2,300	33/2,300	EAR99	PE15A5016	\$9,585.87	\$9,202.44	\$8,819.00	\$8,435.57	78		
								41.76	33/2,300	33/2,300	EAR99	PE15A5019	\$9,194.12	\$8,826.36	\$8,458.59	\$8,090.83
High Power, Class AB	8 - 12	43	2	43	28/5,000	28/5,000	28/5,000	EAR99	PE15A5071	\$11,283.33	\$10,606.33	\$10,042.16	\$9,590.83	80		
		46						28/9,000	28/9,000	EAR99	PE15A5072	\$18,050.00	\$16,967.00	\$16,064.50	\$15,342.50	81

RACK MOUNT VARIABLE GAIN AMPLIFIERS



Amplifier Type	Frequency Band (GHz.)	Gain (dB)	Gain Var. ±(dB)	NF (dB)	Atten. Range (dB)	Step Size (dB)	AC Power (VAC)	ECCN	Model No	1	2-4	5-9	10+	ROW
Variable Gain, High Rel	100 MHz - 18	50	2	6.5	0-60	1	120	EAR99	PE15A7000	\$17,332.07	\$16,638.79	\$15,945.50	\$15,252.22	82

AMPLIFIER ACCESSORIES



Model No	Description	1 Pc. Price	See Web for Volume Pricing	ROW
PE15C5014	Heat sink for amplifier models PE15A4011-4015 and PE15A5004-5009	\$640.72		83
PE15G5060F	Heat Sink for amplifier models PE15A5055-5059, PE15A5064-5065, PE15A5068 and PE15A5070	\$706.67		84
PE15G5068F	Heat Sink for amplifier models PE15A5060-5063, PE15A5066-5067, PE15A5069, PE15A5071-5072	\$883.33		85
PE15C5013	Heat Sink for Most RF Power Amplifier PE15A5000 Series	\$451.11		86
PE15G5000	Heat Sink for Most RF Power Amplifier PE15A5000 Series	Call		87
PE15C5022	Heat Sink for Rf Power Amplifier PE15A5022	\$606.28		88
PE15C5013F	Heat Sink with 12V Fan for Most RF Power Amplifier PE15A5000 Series	\$1,293.28	See Web for Volume Pricing	89
PE15G5000F	Heat Sink with 12V Fan including Power and Control Cable for RF Amplifier PE15A5013, PE15A5010	Call		90
PE15G5013F	Heat Sink with 12V Fan including Power and Control Cable for RF Amplifier PE15A5013, PE15A5010	Call		91
PE15C5011F	Heat Sink with 24V Fan and Power and Control Cable for RF Amplifier PE15A5011, PE15A5016, PE15A5017, PE15A5019	\$1,129.20		92
PE15C5022F	Heat Sink with 24V Fan for RF Power Amplifier PE15A5022	\$974.37		93
PE15G5012F	Heat Sink with 24V Fan including Power and Control Cable for RF Amplifier PE15A5012, PE15A5021	Call		94

See Our Website For Current Pricing & Real-Time Stock Availability!

AMPLIFIER ACCESSORIES



Model No	Description	1 Pc. Price	See Web for Volume Pricing			ROW
PE15G5011F	Heat Sink with 24V Fan including Power and Control Cable for RF Power Amplifier PE15A5011, PE15A5016, PE15A5017, PE15A5019	Call				95
PE15A5990	Heat Sink with Fan for RF Power Amplifier PE15A5024, PE15A5025 and PE15A5027	\$2,050.11	See Web for Volume Pricing			96
PE15J5011	Power and Control Cable for RF Amplifier PE15A5011, PE15A5014, PE15A5016, PE15A5017, PE15A5018, PE15A5019, PE15A5020 and PE15A5022	\$231.99				97
PE15J5015	Power and Control Cable for RF Amplifier PE15A5015, PE15A5023	\$125.04				98
PE15K5000	Power and Control Cable for RF Amplifier PE15B5000 and PE15B5001	\$145.08				99
PE15K5002	Power and Control Cable for RF Amplifier PE15B5002	\$117.75				1

Antennas

INDEX GUIDE TO ANTENNAS

ANTENNAS.....	57
DIRECTIONAL ANTENNAS.....	57
Dish.....	58
Fixed.....	58
Yagi.....	58
OMNI DIRECTIONAL ANTENNAS.....	59
Dome.....	59
Duplexed Antenna Kits.....	63
Fixed.....	59
GPS Active.....	60
GPS Passive.....	60
Mobile.....	60
Omni.....	62
Portable.....	60
Rubber Duck.....	61
Vehicular.....	62
ANTENNA MOUNTS.....	63

Directional Antennas

Panel Antennas



RF Frequency Range (MHz)	VSWR	Gain Nominal	Polarization	Model No	1 Pc. Price	See Web for Volume Pricing			ROW
800 - 960 1,710 - 2,170	1.4:1	7 dBi	Vertical	PE51054	Call				2
824 - 960	1.8:1	9 dBi	Vertical / Horizontal	PE51FP1006	\$70.47	See Web for Volume Pricing			3
			LHCP	PE51025	\$155.87				4
902 - 928	1.2:1	9 dBi	RHCP	PE51024	\$162.23				5
			Vertical	PE51023	\$274.12				6
			Vertical / Horizontal	PE51FP1005	\$74.14				7
			LHCP	PE51FP1007	\$61.97				8
2,300 - 2,500	1.6:1	9 dBi	RHCP	PE51FP1008	\$61.97				9
			Vertical / Horizontal	PE51019-2	Call				10
2,400 - 2,500	1.7:1	19 dBi	Vertical / Horizontal	PE51019-4	Call				11
2,400 - 2,500 4,900 - 5,850	2:1	11 dBi	Vertical / Horizontal	PE51049	Call				12
		14 dBi	Vertical / Horizontal	PE51FP1003	\$249.99				13
		23 dBi	Vertical / Horizontal	PE51FP1004	\$180.75	14			
4,900 - 5,850	1.5:1	10 dBi	Vertical / Horizontal	PE51FP1002	\$182.30	15			
		10 dBi	Vertical / Horizontal	PE51FP1001	\$47.28	16			
		10 dBi	Vertical / Horizontal	PE51FP1010	\$112.54	17			
	1.8:1	19 dBi	Vertical / Horizontal	PE51FP1011	\$114.78	18			

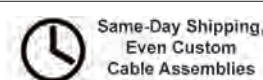

Panel Antennas



RF Frequency Range (MHz)	VSWR	Gain Nominal	Polarization	Model No	1 Pc. Price	See Web for Volume Pricing			ROW
5,725 - 5,850	1.5:1	19 dBi	Vertical / Horizontal	PE51050	\$229.45				19
		22 dBi	Vertical / Horizontal	PE51052	Call				20

Fixed Antennas



RF Frequency Range (MHz)	VSWR	Gain Nominal	Polarization	Model No	1-4	5-9	10-24	25+	ROW
4,400 - 6,400	1.5:1	9 dBi	Vertical	PE51129	\$523.07	\$502.15	\$486.46	\$475.99	21

Yagi Antennas



RF Frequency Range (MHz)	VSWR	Gain Nominal	Polarization	Model No	1 Pc. Price	See Web for Volume Pricing			ROW				
824 - 960	1.5:1	3 dBi	Vertical / Horizontal	PE51YA1007	\$37.50				22				
		6 dBi	Vertical / Horizontal	PE51YA1008	\$41.66				23				
		9 dBi	Vertical / Horizontal	PE51YA1009	\$46.16				24				
		12 dBi	Vertical / Horizontal	PE51YA1010	\$49.53				25				
		14 dBi	Vertical / Horizontal	PE51YA1011	\$59.09				26				
890 - 960	2.1:1	11 dBi	Vertical / Horizontal	PE51171	\$354.84				27				
		9 dBi	Vertical / Horizontal	PE51YA1012	\$48.41		See Web for Volume Pricing		28				
		13 dBi	Vertical / Horizontal	PE51YA1013	\$73.88			29					
14 dBi	Vertical / Horizontal	PE51YA1014	\$163.18		30								
900 - 928	1.5:1	12 dBi	Vertical	PE51YA1004	\$61.97				31				
2,400 - 2,483									32				
2,400 - 2,500						9 dBi	Vertical / Horizontal	PE51YA1001	\$66.53				33
						12 dBi	Vertical / Horizontal	PE51YA1002	\$74.14				34
4,900 - 5,850						15 dBi	Vertical / Horizontal	PE51YA1003	\$73.16				35
5,725 - 5,825	17 dBi	Vertical / Horizontal	PE51YA1006	\$203.68				36					
			Vertical	PE51YA1005	\$93.31				36				

Dish Antennas



RF Frequency Range (MHz)	VSWR	Gain Nominal	Polarization	Model No	1-24	25-49	50-99	100+	ROW
2,400 - 2,500	1.5:1	18 dBi	H / V / 45 Deg. Slant	PE51PD1004	\$157.55	\$149.67	\$141.80	\$135.49	37
		22 dBi	H / V / 45 Deg. Slant	PE51PD1005	\$187.92	\$178.52	\$169.13	\$161.61	38
		25 dBi	H / V / 45 Deg. Slant	PE51PD1006	\$339.83	\$322.84	\$305.85	\$292.25	39
4,750 - 5,850	1.5:1	30 dBi	H / V / 45 Deg. Slant	PE51PD1002	\$200.30	\$190.29	\$180.27	\$172.26	40
5,400 - 5,800		34 dBi	H / V / 45 Deg. Slant	PE51PD1003	\$351.09	\$333.54	\$315.98	\$301.94	41
4,750 - 5,850		25 dBi	H / V / 45 Deg. Slant	PE51PD1001	\$169.91	\$161.41	\$152.92	\$146.12	42

Log Antennas



RF Frequency Range (MHz)	VSWR	Gain Nominal	Polarization	Model No	1-24	25-49	50-99	100+	ROW
698 - 960 1,710 - 2,500	1.6:1	10 dBi	Vertical / Horizontal	PE51LP1001	\$82.16	\$78.05	\$73.94	\$70.66	43
2,400 - 6,500	1.5:1	8 dBi	Vertical	PE51LP1002	\$88.91	\$84.46	\$80.02	\$76.46	44

Sector Antennas



RF Frequency Range (MHz)	VSWR	Gain Nominal	Polarization	Model No	1-24	25-49	50-99	100+	ROW
698 - 960 1,710 - 2,700	1.6:1	14 dBi	Vertical	PE51SE1006	\$373.85	\$355.16	\$336.47	\$321.51	45
	1.9:1	10 dBi	45 Deg. Slant	PE51SE1004	\$241.95	\$229.85	\$217.76	\$208.08	46
	1.8:1	12 dBi	Vertical	PE51SE1005	\$359.79	\$341.80	\$323.81	\$309.42	47
900 - 930	2:1	13 dBi	Horizontal	PE51SE1003	\$286.95	\$272.60	\$258.26	\$246.78	48
902 - 928	1.5:1		Vertical / Horizontal	PE51FP1009	\$399.00	\$379.05	\$359.10	\$343.14	49
2,400 - 2,500	1.3:1	20 dBi	Vertical	PE51SE1009	\$483.88	\$459.69	\$435.49	\$416.14	50
	1.5:1	14 dBi	Vertical / Horizontal	PE51SE1001	\$232.94	\$221.29	\$209.65	\$200.33	51
2,400 - 2,500 4,900 - 5,850	2:1	13 dBi	Vertical / Horizontal	PE51SE1002	\$451.71	\$429.12	\$406.54	\$388.47	52
2,400 - 2,500 5,725 - 5,875	1.5:1	5 dBi	Vertical / Horizontal	PE51SE1007	\$60.69	\$57.66	\$54.62	\$52.19	53
4,900 - 5,850	1.7:1	16 dBi	Vertical / Horizontal	PE51SE1008	\$135.05	\$128.30	\$121.55	\$116.14	54

Omni Directional Antennas

Dome Antennas



RF Frequency Range (MHz)	VSWR	Gain Nominal	Polarization	Model No	1 Pc. Price	See Web for Volume Pricing			ROW
698 - 960 1,710 - 2,700	1.7:1	5 dBi	Vertical	PE51158	\$35.34	See Web for Volume Pricing			55
698 - 960 1,710 - 2,170	1.8:1	6 dBi	Vertical	PE51168	Call				56
800 - 960 1,710 - 2,500	1.4:1	5 dBi	Vertical	PE51098-1	Call				57
			Vertical	PE51098-2	Call				58
			Vertical	PE51098-3	Call				59
			Vertical	PE51098-4	Call				60
800 - 3,000	2:1	3 dBi	Vertical	PE51057	\$268.16				61
			Vertical	PE51059	\$411.27				62
806 - 960 1,710 - 2,500	1.5:1	8 dBi	Vertical	PE51058	\$330.55				63
			Vertical	PE51096	\$47.50				64

Fixed Antennas



RF Frequency Range (MHz)	VSWR	Gain Nominal	Polarization	Model No	1 Pc. Price	See Web for Volume Pricing			ROW
902 - 928	2:1	5 dBi	Vertical	PE51028	\$224.59	See Web for Volume Pricing			65
2,250 - 2,350	1.43:1	3 dB	Vertical	PE51062	\$132.05				66
2,350 - 2,450	1.3:1	3 dBi	Vertical	PE51063	\$284.68				67
2,400 - 2,483	1.5:1	1 dBi	Vertical	PE51030	Call				68
2,400 - 2,500	2:1	8 dBi	Vertical	PE51061	\$262.52				69
	2.1:1		Vertical	PE51172	\$163.34				70
2,450 - 2,550	1.43:1	3 dB	Vertical	PE51064	\$156.55				71
3,400 - 3,600	1.5:1	9 dBi	Vertical	PE51033	Call				72
		11 dBi	Vertical	PE51034	\$103.39				73
3,450 - 3,550	1.4:1	3 dBi	Vertical	PE51065	\$134.57				74
5,470 - 5,725	1.5:1	1 dBi	Vertical	PE51036	Call				75
		12 dBi	Vertical	PE51037	\$82.42				76
5,725 - 5,850			Vertical	PE51040	\$117.07				77

Antennas

See Our Website For Current Pricing & Real-Time Stock Availability!

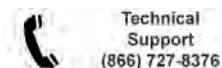

GPS Active Antennas



RF Frequency Range (MHz)	VSWR	Gain Nominal	Polarization	Model No	1 Pc. Price	See Web for Volume Pricing			ROW
1,570 - 1,580	1.3:1	32 dBiC	RHCP	PE51067	\$380.36				78
1,574 - 1,610	2:1	32 dBi		PE51TM1000	\$161.05				79

GPS Passive Antennas



RF Frequency Range (MHz)	VSWR	Gain Nominal	Polarization	Model No	1 Pc. Price	See Web for Volume Pricing			ROW
1,220 - 1,230 1,530 - 1,580	2:1	6 dBiC	RHCP	PE51068	\$1,054.12	See Web for Volume Pricing			80
1,572.42 - 1,578.42	1.5:1	3 dBi	RHCP	PE51066-1	\$129.67				81
			RHCP	PE51066-2	\$99.74				82
1,575 - 1,615	2:1	3 dB	RHCP	PE51GPS1004	\$28.85				83

Mobile Antennas



RF Frequency Range (MHz)	VSWR	Gain Nominal	Polarization	Model No	1 Pc. Price	See Web for Volume Pricing			ROW
40 - 47	1.5:1	0 dBi	Vertical	PE51000	Call	See Web for Volume Pricing			84
118 - 940	1.5:1		Vertical	PE51001	\$23.14				85
132 - 512	2:1		Vertical	PE51003	Call				86
440 - 480		5 dBi	Vertical	PE51170	Call				87
474.5 - 479.5	1.5:1	6 dBi	Vertical	PE51060	\$119.95				88
806 - 950 1,850 - 1,900	2:1	3 dBi	Vertical	PE51013	Call				89
824 - 896 1,850 - 1,990	1.5:1	2 dBi	Vertical	PE51014	Call				90
825 - 896		5 dB	Vertical	PE51009	Call				91
870 - 950		5 dBi	Vertical	PE51010	Call				92
880 - 965 1,710 - 2,170	2:1	3 dBi	Vertical	PE51113-1	\$50.19				93
			Vertical	PE51113-2	\$55.56	94			
			Vertical	PE51113-3	\$43.60	95			
			Vertical	PE51113-4	\$45.40	96			
900 - 960 2,400 - 2,500	1.5:1		Vertical	PE51MO1001	\$70.44	97			
			Vertical	PE51MO1002	\$63.93	98			
902 - 928	2:1	4 dBi	Vertical	PE51027	\$41.12	99			
2,400 - 2,500 900 - 960	1.5:1	3 dBi	Vertical	PE51OM1022	\$91.84	1			
			Vertical	PE51MO1003	\$89.36	2			
			Vertical	PE51OM1023	\$86.62	3			
2,400 - 2,500		3 dB	Vertical	PE51136	\$114.24	4			

Portable Antennas



RF Frequency Range (MHz)	VSWR	Gain Nominal	Polarization	Model No	1 Pc. Price	See Web for Volume Pricing			ROW
118 - 174	2:1	dBi	Vertical	PE51TW1000	\$31.15	See Web for Volume Pricing			5
400 - 420		2 dBi	Vertical	PE51145	Call				6
		Vertical	PE51146	\$20.98	7				
420 - 450		dBi	Vertical	PE51159	\$24.21				8
		Vertical	PE51160	\$16.19	9				
450 - 470		Vertical	PE51148	\$25.16	10				

Portable Antennas



RF Frequency Range (MHz)	VSWR	Gain Nominal	Polarization	Model No	1 Pc. Price	See Web for Volume Pricing				ROW
450 - 470	2:1	dBi	Vertical	PE51149	Call	See Web for Volume Pricing				11
470 - 512			Vertical	PE51161	\$19.42					12
482 - 512	1.5:1		Vertical	PE51162	\$16.19					13
			Vertical	PE51147	\$15.38					14
698 - 780	2:1	Vertical	PE51153	\$16.40	15					
698 - 870		2:1	Vertical	PE51157	\$18.74					16
	Vertical		PE51152	\$19.96	17					
	2.2:1	Vertical	PE51150	\$20.18	18					
	2.3:1	Vertical	PE51154	\$24.58	19					
760 - 870	2.5:1	Vertical	PE51151	\$20.18	20					
		Vertical	PE51163	\$15.77	21					
806 - 880	2:1	dBi	Vertical	PE51166	\$22.48	22				
			Vertical	PE51155	\$16.40	23				
Vertical			PE51156	\$23.95	24					
Vertical			PE51164	\$15.77	25					
880 - 960			Vertical	PE51165	\$19.20	26				
			Vertical	PE51089-1	\$43.22	27				
890 - 960 1,710 - 1,880	1.5:1	3 dBi	Vertical	PE51089-2	\$37.44	28				
			Vertical	PE51089-3	\$35.58	29				
Vertical			PE51089-4	\$35.80	30					
Vertical			PE51056	\$46.68	31					
900 - 960	2.1:1	3 dBi	Vertical	PE51055	\$93.51	32				
902 - 928	Vertical		PE51026	\$23.12	33					
1,700 - 1,850	2:1	4 dBi	Vertical	PE51119	\$524.74	34				
			Vertical	PE51120	\$554.86	35				
1,700 - 2,500		2 dBi	Vertical	PE51177A	\$713.60	36				
			Vertical	PE51173	\$437.89	37				
1,900 - 2,500		4 dBi	Vertical	PE51121	\$678.77	38				
			Vertical	PE51122	\$543.56	39				
2,200 - 2,500	6 dBi	Vertical	PE51123	\$588.66	40					
2,300 - 2,700		Vertical	PE51124	\$460.60	41					
2,400 - 2,483.5	1.5:1	2 dBi	Vertical	PE51090	\$16.17	42				
	2.1:1		Vertical	PE51018	Call	43				
2,400 - 2,500	1.43:1	3 dBi	Vertical	PE51133	\$182.80	44				
		2 dBi	Vertical / Horizontal	PE51077	\$35.75	45				
	2:1	3 dBi	Vertical	PE51076	\$34.06	46				
		6 dBi	Vertical	PE51078	\$21.01	47				
2,400 - 2,500 4,900 - 5,800	2.5:1	3 dBi	Vertical	PE51087	\$26.74	48				
2,400 - 2,500 4,900 - 5,100		Vertical	PE51088	\$35.75	49					
2,400 - 2,500 4,900 - 5,825	2:1	2 dBi	Vertical	PE51080	\$31.01	50				
			Vertical	PE51082	\$22.82	51				
			Vertical	PE51083	\$19.13	52				
3,300 - 3,800	3 dBi	Vertical	PE51081	\$23.36	53					
		Vertical	PE51072	\$28.13	54					
3,400 - 3,800	2 dBi	Vertical	PE51084	\$33.35	55					
		Vertical	PE51085	\$18.64	56					
4,400 - 5,000	5 dBi	Vertical	PE51135A	\$536.34	57					
		Vertical	PE51134	\$843.62	58					
5,100 - 5,900	2:1	5 dBi	Vertical	PE51070	Call	59				
5,250 - 5,850			Vertical	PE51125A	\$530.21	60				
			Vertical	PE51126	\$456.16	61				
			Vertical	PE51127	\$556.26	62				
			Vertical	PE51128	\$456.16	63				
2,400 - 2,500 5,000 - 5,900			4 dBi	Vertical	PE51142	\$28.09	64			
	Vertical	PE51143		\$18.01	65					
		4 dBi	Vertical	PE51144	\$17.33	66				

Antennas

See Our Website For Current Pricing & Real-Time Stock Availability!

Rubber Duck Antennas



RF Frequency Range (MHz)	VSWR	Gain Nominal	Polarization	Model No	1-24	25-49	50-99	100+	ROW
2,400 - 2,500	2:1	6 dBi	Vertical	PE51RD1007	\$13.64	\$12.96	\$12.28	\$11.73	67

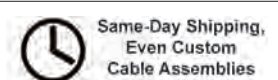

Rubber Duck Antennas



RF Frequency Range (MHz)	VSWR	Gain Nominal	Polarization	Model No	1-24	25-49	50-99	100+	ROW
2,400 - 2,500 4,900 - 5,350 5,725 - 5,850	2:1	3 dBi	Vertical	PE51RD1002	\$18.59	\$17.66	\$16.73	\$15.99	68
			Vertical	PE51RD1004	\$18.76	\$17.82	\$16.88	\$16.13	69
			Vertical	PE51RD1003	\$19.13	\$18.17	\$17.22	\$16.45	70
2,400 - 2,500 5,150 - 5,850	2:1	5 dBi	Vertical	PE51RD1006	\$30.39	\$28.87	\$27.35	\$26.14	71
2,400 - 2,483 5,100 - 5,900		3 dBi	Vertical	PE51RD1005	\$23.64	\$22.46	\$21.28	\$20.33	72

Vehicular Antennas



RF Frequency Range (MHz)	VSWR	Gain Nominal	Polarization	Model No	1-24	25-49	50-99	100+	ROW
108 - 520	2:1	2 dBi	Linear, Vertical	PE51MP1000	\$54.54	\$50.72	\$46.90	\$43.63	73
132 - 174	1.5:1	3 dBi	Linear, Vertical	PE51MP1001	\$68.08	\$63.31	\$58.55	\$54.46	74
	2:1	2 dBi	Linear, Vertical	PE51MP1002	\$74.44	\$69.23	\$64.02	\$59.55	75
144 - 174	1.5:1	3 dBi	Linear, Vertical	PE51MP1004	\$68.08	\$63.31	\$58.55	\$54.46	76
			Linear, Vertical	PE51MP1003	\$99.23	\$92.28	\$85.34	\$79.38	77
	2:1	2 dBi	Linear, Vertical	PE51MP1009	\$74.44	\$69.23	\$64.02	\$59.55	78
380 - 520	1.5:1	3 dBi	Linear, Vertical	PE51MP1005	\$68.33	\$63.55	\$58.76	\$54.66	79
420 - 470			Linear, Vertical	PE51MP1006	\$61.74	\$57.42	\$53.10	\$49.39	80
440 - 480	2:1	5 dBi	Linear, Vertical	PE51MP1007	\$72.13	\$67.08	\$62.03	\$57.70	81
		3 dBd	Linear, Vertical	PE51MP1008	\$77.13	\$71.73	\$66.33	\$61.70	82
450 - 520 746 - 960	2:1	2 dBi	Linear, Vertical	PE51MP1011	\$73.85	\$68.68	\$63.51	\$59.08	83
698 - 960 1,710 - 2,150		3 dBi	Linear, Vertical	PE51MP1010	\$62.31	\$57.95	\$53.59	\$49.85	84
824 - 960 1,710 - 1,990		2 dBi	Vertical	PE51GM1001	\$17.98	\$16.72	\$15.46	\$14.38	85

Omni Antennas



RF Frequency Range (MHz)	VSWR	Gain Nominal	Polarization	Model No	1-24	25-49	50-99	100+	ROW	
698 - 960 1,710 - 2,700	1.6:1	4 dBi	Vertical	PE51OM1020	\$55.68	\$52.90	\$50.11	\$47.88	86	
824 - 928 900 - 928	1.7:1	9 dBi	Vertical / Horizontal	PE51OM1021	\$750.00	\$712.50	\$675.00	\$645.00	87	
			3 dBi	Vertical	PE51OM1013	\$67.53	\$64.15	\$60.78	\$58.08	88
824 - 960	1.5:1	6 dBi	Vertical	PE51OM1014	\$74.67	\$70.94	\$67.20	\$64.22	89	
			Vertical	PE51OM1015	\$114.80	\$109.06	\$103.32	\$98.73	90	
	1.6:1	8 dBi	Vertical	PE51OM1016	\$167.18	\$158.82	\$150.46	\$143.77	91	
			Vertical	PE51OM1019	\$118.06	\$112.16	\$106.25	\$101.53	92	
	2,400 - 2,500	2:1	3 dBi	Vertical	PE51OM1017	\$70.44	\$66.92	\$63.40	\$60.58	93
6 dBi				Vertical	PE51OM1018	\$86.70	\$82.37	\$78.03	\$74.56	94
7 dBi				Vertical	PE51OM1025	\$113.68	\$108.00	\$102.31	\$97.76	95
2,400 - 2,500 5,100 - 5,800	1.5:1	8 dBi	Vertical	PE51OM1026	\$83.19	\$79.03	\$74.87	\$71.54	96	
			Vertical	PE51OM1024	\$87.78	\$83.39	\$79.00	\$75.49	97	
			Vertical / Horizontal	PE51OM1009	\$231.68	\$220.10	\$208.51	\$199.24	98	
	1.6:1	6 dBi	Vertical / Horizontal	PE51OM1007	\$281.31	\$267.24	\$253.18	\$241.93	99	
			Vertical / Horizontal	PE51OM1008	\$337.59	\$320.71	\$303.83	\$290.33	1	
			Vertical / Horizontal	PE51OM1010	\$286.83	\$272.49	\$258.15	\$246.67	2	
2,400 - 2,500 4,900 - 5,850	2:1	dBi	Vertical / Horizontal	PE51OM1011	\$355.68	\$337.90	\$320.11	\$305.88	3	
			Vertical	PE51OM1001	\$46.16	\$43.85	\$41.54	\$39.70	4	
2,400 - 2,500 5,725 - 5,850	1.5:1	6 dBi	Vertical	PE51OM1004	\$123.79	\$117.60	\$111.41	\$106.46	5	
	1.6:1	9 dBi	Vertical	PE51OM1005	\$135.05	\$128.30	\$121.55	\$116.14	6	
2,400 - 2,500 4,900 - 5,850	1.8:1	4 dBi	Vertical	PE51OM1012	\$151.92	\$144.32	\$136.73	\$130.65	7	

Antennas

See Our Website For Current Pricing & Real-Time Stock Availability!

Omni Antennas



RF Frequency Range (MHz)	VSWR	Gain Nominal	Polarization	Model No	1-24	25-49	50-99	100+	ROW
2,400 - 2,500 4,900 - 5,850	2.5:1	6 dBi	Vertical	PE51OM1002	\$54.03	\$51.33	\$48.63	\$46.47	8
		8 dBi	Vertical	PE51OM1003	\$63.03	\$59.88	\$56.73	\$54.21	9
2,400 - 2,500 5,100 - 5,900	1.8:1	6 dBi	Vertical / Horizontal	PE51OM1006	\$225.06	\$213.81	\$202.55	\$193.55	10

Duplexed Antenna Kits Antennas



RF Frequency Range (MHz)	VSWR	Contains	Model No	1-24	25-49	50-99	100+	ROW
100 - 180 380 - 520	1.6:1	Duplexer (VHF/UHF 108-174 MHz/380-870 MHz), with integral N-type (m) Connectors (3 ea.); Low Loss 195 NMO mount with cable (1 ea.); RG-58/U NMO mount with cable (1 ea.); Field Tunable Antennas (2 ea.)//RG-58/U Feed Cable (1 ea.)	PE51AK1000	\$256.15	\$238.22	\$220.29	\$204.92	11
		Duplexer (VHF/UHF 108-174MHz/380-870MHz) with integral N-Type (m) Connectors (3 ea.); Low Loss PE51GPS1000 NMO Combination mount with integrated GPS antenna (1 ea.); RG-58/U NMO mount (1 ea.); Field Tunable Antennas (2 ea.); RG-58/U Feed Cable (1 ea.); PE51GPS1000 NMO Combination mount with integrated GPS antenna	PE51AK1001	\$327.69	\$304.75	\$281.81	\$262.15	12
		Duplexer (VHF/UHF 108-174MHz/450-520MHz/746-870MHz) with integral N-Type (m) Connectors (3 ea.); Low Loss PE51GPS1000 NMO Combination mount with integrated GPS antenna (1 ea.); RG-58/U NMO mount (1 ea.); PE51MP1011 multiband antenna (1 ea.); PE51MP1000 tunable VHF/UHF antenna (1 ea.)//RG-58/U Feed Cable (1 ea.)	PE51AK1002	\$426.92	\$397.04	\$367.15	\$341.54	13
		Duplexer (VHF/UHF 108-174MHz/450-520MHz/746-870MHz) with integral N-type (m) Connectors (3 ea.); Low loss 195 NMO mount (1 ea.); RG-58/U NMO mount (1 ea.); PE51MP1011 multiband antenna (1 ea.); PE51MP1000 tunable VHF/UHF antenna (1 ea.); RG-58/U Feed Cable (1 ea.)	PE51AK1003	\$338.46	\$314.77	\$291.08	\$270.77	14

Antenna Mounts



RF Frequency Range (MHz)	VSWR	Gain Nominal	Description	Model No	1-24	25-49	50-99	100+	ROW
0 - 0	1.2:1		Ground Plane Converter Kit, NMO to N Female for pole mounting	PE51AK1004	\$46.15	\$42.92	\$39.69	\$36.92	15
	2:1	3 dB	NMO Mount Combo 30 dB GPS Vehicular Antenna NMO Mount/SMA Connectors RG58 cable	PE51GPS1000	\$126.92	\$118.04	\$109.15	\$101.54	16
			NMO Mount Combo 30 dB GPS Vehicular Antenna NMO Mount/SMA Connectors LL195 cable	PE51GPS1001	\$144.23	\$134.13	\$124.04	\$115.38	17
1,575 - 1,615	2:1	28 dB	NMO Mount Combo 28 dB GPS/GLNSS Vehicular Antenna NMO Mount/SMA Connectors RG58 cable	PE51GPS1002	\$126.92	\$118.04	\$109.15	\$101.54	18
			NMO Mount Combo 28 dB GPS/GLNSS Vehicular Antenna NMO Mount/SMA Connectors LL195 cable	PE51GPS1003	\$144.23	\$134.13	\$124.04	\$115.38	19
1,574 - 1,610	2:1	32 dBi	32 dBi Mount Kit and Timing GPS/GLNSS Antenna 1,574-1,610 MHz TNC Connector	PE51TM1001	\$196.05	\$182.33	\$168.60	\$156.84	20

Antennas

See Our Website For Current Pricing & Real-Time Stock Availability!

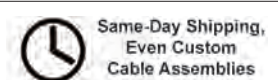

Attenuators and Equalizers Selection Guide

3 Easy Ways to Find your Product.....

1. Search by PE Part Number

If you know the PE part number you are searching for, please reference our Part Number Index on Page [355](#).

2. Quick Reference Guide

Attenuators.....	66
CMOS, Relay, TTL and USB Controlled Attenuators.....	81
Continuously Variable Attenuators	
50 Ohm.....	81
DC Bias Attenuators	
50 Ohm.....	81
75 Ohm.....	81
Fixed Attenuators	
50 Ohm.....	66
75 Ohm.....	78
Step Attenuators, Push Button	
50 Ohm.....	79
75 Ohm.....	80
Step Attenuators, Rotary	
50 Ohm.....	80
75 Ohm.....	80
Step Attenuators, Toggle	
75 Ohm.....	80
Voltage Variable Attenuators.....	82
Equalizers.....	82

3. Attenuators Locator

Connector In-Out	Max Freq.	Power	Model No.	Page
1.85mm Male				
1.85mm Female	65 GHz	1 W	PE7403	66
2.4mm Female				
2.4mm Female	40 GHz	0.25 W	PE70A6001	82
2.4mm Male				
2.4mm Female	50 GHz	1 W	PE7089	66
2.92mm Female				
2.92mm Female	18 GHz	0.25 W	PE70A5001	82
		0.1 W	PE70A3901	82
		0.25 W	PE70A5002	82
2.92mm Female	40 GHz	0.5 W	PE7024	67
		1 W	PE7024/SP	67
		2 W	PE7AP412	66
2.92mm Female	40 GHz	0.5 W	PE7046	66
		1 W	PE7088	66
		2 W	PE7090	67
		5 W	PE7395	67
		10 W	PE7AP402	71
4.3-10 Male				
4.3-10 Female	6 GHz	15 W	PE7AP1001	72
7/16 DIN Female				
7/16 DIN Female	6 GHz	25 W	PE7380	72
		50 W	PE7313	74
		100 W	PE7204	76

Connector In-Out	Max Freq.	Power	Model No.	Page
7/16 DIN Female				
7/16 DIN Male	6 GHz	50 W	PE7310	74
		100 W	PE7201	76
N Female	6 GHz	50 W	PE7321	74
		100 W	PE7316	74
N Male	6 GHz	50 W	PE7212	76
		100 W	PE7207	76
7/16 DIN Male				
7/16 DIN Female	1.5 GHz	100 W	PE7043	75
		25 W	PE7379	72
		50 W	PE7312	73
	6 GHz	100 W	PE7203	75
		5 W	PE7039	70
		10 W	PE7040	71
		25 W	PE7041	72
7.5 GHz	50 W	PE7042	73	
	100 W	PE7211	75	
N Female	6 GHz	100 W	PE7211	75
BNC Female				
BNC Female	0.5 GHz	1 W	PE7035	80
			PE70A1001	80
	1 GHz	2 W	PE7034	80
			PE70A1024	80
	2.2 GHz	2 W	PE70A1022	80
			PE7008	80
DC-500	1 W	PE7008	80	
		PE70A1021	79	

Attenuators Locator

Connector In-Out	Max Freq.	Power	Model No.	Page
BNC Male				
BNC Female	1 GHz	1 W	PE7009	78
		100 W	PE7026	76
	2 GHz	1 W	PE7000	66
		10 W	PE7025	71
4 GHz	2 W	PE7049	68	
			PE7050	79
F Female				
F Female	1 GHz	1 W	PE70A1008	80
			PE70A8003	81
			PE70A8004	81
	2.15 GHz	0 W	PE70A5011	82
		30 W	PE70A5012	82
F Male				
F Female	1 GHz	2 W	PE7057	79
	2 GHz		PE7064	81
	3 GHz		PE7396	79
N Female				
7/16 DIN Female	6 GHz	25 W	PE7369	73
		50 W	PE7315	75
		100 W	PE7206	77
7/16 DIN Male	6 GHz	25 W	PE7370	73
		50 W	PE7311	75
		100 W	PE7202	77
N Female	18 GHz	25 W	PE7371	73
		50 W	PE7323	75
	3 GHz	300 W	PE7411	78
N Male	18 GHz	50 W	PE7317	75
		6 GHz	100 W	PE7208
	18 GHz	25 W	PE7372	73
N Male				
7/16 DIN Female	6 GHz	25 W	PE7366	72
		50 W	PE7314	74
		100 W	PE7205	76
N Female	1 GHz	1 W	PE7029	79
		300 W	PE7031	78
		500 W	PE7032	78
			PE7084	78
	1.5 GHz	100 W	PE7021	76
		12.4 GHz	10 W	PE7048
	18 GHz	2 W	PE7004	68
			PE7047	68
		5 W	PE7014	70
			PE7015	71
		10 W	PE7017	72
			PE7019	74
	25 W	PE7322	74	
		PE7062	81	
		PE7010	71	
	2.4 GHz	500 W	PE7085	78
	2.5 GHz	1000 W	PE7423	78
	3 GHz	1 W	PE7002	67
			PE7390	70
		5 W	PE7386	71
			PE7388	74
		10 W	PE7389	74
			PE7385	76
	200 W	PE7387	78	
		PE7044	79	
		25 W	PE7392	72
	4 GHz	50 W	PE7394	74
100 W		PE7421	76	
5 W		PE7AP006	70	
6 GHz	100 W	PE7213	77	
	150 W	PE7AP150	78	
TNC Female	6 GHz	100 W	PE7237	77
QMA Male				
QMA Female	6 GHz	1 W	PE7AP1002	67
QN Male				
QN Female	3 GHz	1 W	PE7AP1000	67
SMA Female				
SMA Female	1 GHz	0.5 W	PE70A8000	81
		1 W	PE70A8001	81

Connector In-Out	Max Freq.	Power	Model No.	Page		
SMA Female						
SMA Female	1.5 GHz	1 W	PE70A8005	81		
	12 GHz	0 W	PE70A2002	82		
	13 GHz	0.16 W	PE70A4000	82		
			PE70A5003	81		
		0 W	PE70A2003	82		
			0.1 W	PE70A3900	82	
	18 GHz	1 W	PE70A6000	82		
		20 W	PE70A2900	82		
		25 W	PE7363	73		
		50 W	PE7337	75		
		0.5 W	PE70A8002	81		
	2 GHz	2 W	PE70A1025	80		
		10 W	PE70A1023	80		
	2.2 GHz	2 W	PE70A1031	82		
		10 W	PE70A1017	82		
	20 GHz	18 W	PE70A5004	82		
		0 W	PE70A5006	82		
	3 GHz	0 W	PE70A5005	82		
			PE70A5007	82		
			PE70A5008	82		
			PE70A2000	82		
	4 GHz	5 W	PE7422	81		
			PE70A5009	82		
	6 GHz	0 W	PE70A5013	82		
			PE70A5010	82		
			PE70A3902	82		
			PE70A1000	82		
PE70A5000			82			
PE7228			78			
8 GHz	0 W	PE70A2001	82			
		100 W	PE7221	77		
SMA Male						
SMA Female	1.5 GHz	100 W	PE7022	77		
	12.4 GHz	2 W	PE7045	69		
			PE7005	69		
			PE7092	69		
			PE7013	71		
	18 GHz	10 W	PE7016	72		
			PE7018	73		
			PE7357	73		
			PE7020	75		
	50 W	PE7427	75			
		1 W	PE7161	67		
	2 GHz	1 W	PE7061	81		
	26 GHz	2 W	PE7087	69		
			PE7001	68		
	3 GHz	5 W	PE7391	70		
			PE7393	73		
	4 GHz	25 W	PE70A1009	68		
			PE70A1010	68		
			PE70A1011	68		
			PE70A1012	68		
			PE70A1013	68		
			PE70A1014	68		
			PE70A1015	68		
			PE7091	68		
			PE7162	69		
			10 W	PE7428	72	
			100 W	PE7227	77	
TNC Female						
N Female			6 GHz	100 W	PE7218	78
N Male			6 GHz	100 W	PE7210	78
TNC Female	18 GHz	50 W	PE7351	75		
TNC Male						
TNC Female	1.5 GHz	100 W	PE7056	78		
		12.4 GHz	2 W	PE7051	70	
	18 GHz	2 W	PE7030	70		
			PE7052	71		
		5 W	PE7053	72		
			PE7054	73		
		10 W	PE7375	73		
			PE7055	75		
		25 W	PE7003	67		
			PE7063	81		

Attenuators & Equalizers



Technical Support
(866) 727-8376



Same-Day Shipping,
Even Custom
Cable Assemblies

PASSIVE ATTENUATORS

Fixed Attenuators

50 Ohm



Attenuators & Equalizers

See Our Website For Current Pricing & Real-Time Stock Availability!

Max. Power (Watts)	Connector Input	Connector Output	Max. Freq.	Construction Material	VSWR Max.	Bi-Dir.*	ATTN. (dB)	Model No	1 Pc. Price	See Web for Volume Pricing	ROW
0.5 W	2.92mm Male	2.92mm Female	40 GHz	Passivated Stainless Steel	1.4:1		0	PE7AP412-00	\$239.97	See Web for Volume Pricing	1
							1	PE7AP412-01	\$239.79		
							2	PE7AP412-02	\$239.79		
							3	PE7AP412-03	\$238.94		
						Yes	3	PE7046-3	\$477.94		
						Yes	6	PE7046-6	\$477.94		
						Yes	10	PE7046-10	\$462.71		
						Yes	20	PE7046-20	\$477.94		
						Yes	30	PE7046-30	\$477.94		
							4	PE7AP412-04	\$259.61		
						5	PE7AP412-05	\$249.87			
						6	PE7AP412-06	\$254.39			
						8	PE7AP412-08	\$264.17			
						9	PE7AP412-09	\$254.25			
						10	PE7AP412-10	\$259.61			
						12	PE7AP412-12	\$249.87			
						15	PE7AP412-15	\$249.87			
						20	PE7AP412-20	\$259.61			
						30	PE7AP412-30	\$258.75			
					1 W	1.85mm Male	1.85mm Female	65 GHz	Passivated Stainless Steel		1.65:1
	2	PE7403-2	\$718.99								
	3-3	PE7403-3	\$627.43								
	4	PE7403-4	\$692.00								
	5	PE7403-5	\$692.00								
	6-6	PE7403-6	\$616.22								
	7	PE7403-7	\$692.00								
	8	PE7403-8	\$692.00								
	10-10	PE7403-10	\$627.43								
	15-15	PE7403-15	Call								
	20-20	PE7403-20	\$627.71								
	30-30	PE7403-30	\$648.50								
Yes	10	PE7089-10	\$389.72								
Yes	12	PE7089-12	\$389.72								
Yes	15	PE7089-15	\$389.72								
Yes	20	PE7089-20	\$389.53								
Yes	30	PE7089-30	\$388.67								
Yes	0	PE7089-0	\$375.09								
Yes	1	PE7089-1	\$389.72								
Yes	2	PE7089-2	\$389.72								
Yes	3	PE7089-3	\$378.71								
Yes	4	PE7089-4	\$375.09								
Yes	5	PE7089-5	\$375.09								
Yes	6	PE7089-6	\$384.12								
Yes	7	PE7089-7	\$375.09								
Yes	8	PE7089-8	\$389.72								
Yes	9	PE7089-9	\$375.09								
Yes	0	PE7088-0	\$333.97								
Yes	1	PE7088-1	\$318.79								
Yes	2	PE7088-2	\$318.79								
Yes	3	PE7088-3	\$292.72								
Yes	4	PE7088-4	\$333.97								
Yes	5	PE7088-5	\$333.97								
Yes	6	PE7088-6	\$292.52								
Yes	7	PE7088-7	\$333.97								
Yes	8	PE7088-8	\$333.97								
Yes	9	PE7088-9	\$333.97								
Yes	10	PE7088-10	\$303.78								
Yes	12	PE7088-12	\$333.97								
Yes	15	PE7088-15	\$318.79								
Yes	20	PE7088-20	\$292.52								
Yes	30	PE7088-30	\$318.79								
Yes	1	PE7000-1	\$53.69								
Yes	2	PE7000-2	\$53.69								
Yes	3	PE7000-3	\$55.99								
Yes	6	PE7000-6	\$54.54								
Yes	10	PE7000-10	\$53.07								
Yes	20	PE7000-20	\$53.07								
Yes	30	PE7000-30	\$54.54								

* Bi-Dir is Bi-Directional. If No then Attenuator is Directional. Maximum power applies to input connector only.

Fixed Attenuators

50 Ohm



Max. Power (Watts)	Connector Input	Connector Output	Max. Freq.	Construction Material	VSWR Max.	Bi-Dir.*	ATTN. (dB)	Model No	1 Pc. Price	See Web for Volume Pricing	ROW		
1 W	N Male	N Female	3 GHz	Nickel Plated Brass	1.2:1	Yes	1	PE7002-1	\$96.76	See Web for Volume Pricing			
						Yes	2	PE7002-2	\$96.76				
						Yes	3	PE7002-3	\$89.48				
						Yes	6	PE7002-6	\$87.09				
						Yes	10	PE7002-10	\$86.85				
						Yes	20	PE7002-20	\$87.09				
						Yes	30	PE7002-30	\$87.09				
	Yes	40	PE7002-40	\$96.76									
	QMA Male	QMA Female	6 GHz	Tri-Metal Plated Brass	1.2:1		12	PE7AP1002-12	\$90.32				
							15	PE7AP1002-15	\$93.84				
							0	PE7AP1002-0	\$93.84				
							20	PE7AP1002-20	\$93.84				
							1	PE7AP1002-1	\$90.32				
							2	PE7AP1002-2	\$90.32				
							3	PE7AP1002-3	\$90.32				
							6	PE7AP1002-6	\$93.84				
							9	PE7AP1002-9	\$93.84				
							0	PE7AP1000-0	\$128.52				
							1	PE7AP1000-1	\$128.52				
							2	PE7AP1000-2	\$128.52				
	QN Male	QN Female	3 GHz	Tri-Metal Plated Brass	1.2:1		3	PE7AP1000-3	\$128.52				
							6	PE7AP1000-6	\$133.53				
							9	PE7AP1000-9	\$133.53				
							12	PE7AP1000-12	\$128.52				
							15	PE7AP1000-15	\$128.52				
							18	PE7AP1000-18	\$128.52				
							20	PE7AP1000-20	\$133.53				
	SMA Male	SMA Female	2 GHz	Nickel Plated Brass	1.2:1	Yes	1	PE7161-1	\$69.12				
Yes						2	PE7161-2	\$69.12					
Yes						3	PE7161-3	\$65.49					
Yes						4	PE7161-4	\$69.12					
Yes						5	PE7161-5	\$69.12					
Yes						6	PE7161-6	\$63.07					
Yes						8	PE7161-8	\$54.11					
Yes						9	PE7161-9	\$56.54					
Yes						10	PE7161-10	\$66.45					
Yes				12		PE7161-12	\$60.60						
Yes				15		PE7161-15	\$58.46						
Yes				20		PE7161-20	\$64.67						
Yes				30		PE7161-30	\$66.45						
Yes				40		PE7161-40	\$69.71						
Passivated Stainless Steel									Yes	1	PE7003-1	\$84.64	
									Yes	10	PE7003-10	\$77.65	
									Yes	20	PE7003-20	\$74.09	
									Yes	30	PE7003-30	\$79.78	
	Yes	40	PE7003-40		\$84.64								
	TNC Male	TNC Female			Nickel Plated Brass				1.2:1	Yes	1	PE7024-1	\$314.18
										Yes	2	PE7024-2	\$314.18
										Yes	3	PE7024-3	\$304.96
										Yes	6	PE7024-6	\$304.96
Yes				10		PE7024-10	\$297.52						
Yes				20		PE7024-20	\$304.96						
Yes				30		PE7024-30	\$299.00						
Yes				30		PE7024/SP-30	\$205.33						
Passivated Stainless Steel								1.4:1		Yes	3	PE7090-3	\$440.42
										Yes	6	PE7090-6	\$440.42
										Yes	10	PE7090-10	\$411.06
										Yes	15	PE7090-15	\$440.42
	Yes	20	PE7090-20		\$411.06								
	Yes	30	PE7090-30		\$397.31								
	Passivated Stainless Steel		40 GHz		Passivated Stainless Steel				1.6:1		0-0	PE7395-0	\$189.46
											1-1	PE7395-1	\$194.66
											2-2	PE7395-2	\$194.66
											3-3	PE7395-3	\$189.43
											4-4	PE7395-4	\$188.38
											5-5	PE7395-5	\$188.38
				6-6		PE7395-6	\$189.24						
				7-7		PE7395-7	\$222.65						
				8-8		PE7395-8	\$222.65						
				9-9		PE7395-9	\$188.38						

* Bi-Dir is Bi-Directional. If No then Attenuator is Directional. Maximum power applies to input connector only.



Technical Support
(866) 727-8376



Same-Day Shipping,
Even Custom
Cable Assemblies

Attenuators & Equalizers

See Our Website For Current Pricing & Real-Time Stock Availability!

Fixed Attenuators

50 Ohm



Attenuators & Equalizers

See Our Website For Current Pricing & Real-Time Stock Availability!

Max. Power (Watts)	Connector Input	Connector Output	Max. Freq.	Construction Material	VSWR Max.	Bi-Dir.*	ATTN. (dB)	Model No	1 Pc. Price	See Web for Volume Pricing	ROW			
2 W	2.92mm Male	2.92mm Female	40 GHz	Passivated Stainless Steel	1.6:1		10-10	PE7395-10	\$189.43	See Web for Volume Pricing	16			
							12-12	PE7395-12	\$200.42		17			
							15-15	PE7395-15	\$191.63		18			
							20-20	PE7395-20	\$194.66		19			
	BNC Male	BNC Female	4 GHz	Nickel Plated Brass	1.25:1	Yes	1	PE7049-1	\$119.18		17			
						Yes	2	PE7049-2	\$119.18		18			
						Yes	3	PE7049-3	\$113.25		19			
						Yes	6	PE7049-6	\$113.25		20			
						Yes	10	PE7049-10	\$123.16		21			
						Yes	20	PE7049-20	\$113.25		22			
	N Male	N Female	18 GHz	Passivated Stainless Steel	1.35:1	Yes	30	PE7049-30	\$113.25		23			
						Yes	1	PE7004-1	\$223.98		24			
						Yes	2	PE7004-2	\$223.04		25			
						Yes	3	PE7004-3	\$208.49		26			
						Yes	4	PE7004-4	\$223.04		27			
						Yes	5	PE7004-5	\$223.98		28			
Yes						6	PE7004-6	\$208.29	29					
Yes						7	PE7004-7	\$223.98	30					
Yes						8	PE7004-8	\$180.51	31					
Yes						9	PE7004-9	\$196.76	32					
Yes						10	PE7004-10	\$202.65	33					
Yes						12	PE7004-12	\$211.24	34					
Yes						15	PE7004-15	\$216.43	35					
Yes						20	PE7004-20	\$208.49	36					
Yes						30	PE7004-30	\$208.29	37					
Yes						40	PE7004-40	\$223.04	38					
SMA Male						SMA Female	6 GHz	Copper	1.07:1	Yes	2	PE7047-2	\$175.84	39
										Yes	3	PE7047-3	\$164.98	40
										Yes	4	PE7047-4	\$175.84	41
										Yes	5	PE7047-5	\$175.84	42
	Brass	1.22:1	Yes	6	PE7047-6			\$164.04	43					
			Yes	7	PE7047-7			\$161.32	44					
			Yes	8	PE7047-8			\$140.17	45					
			Yes	9	PE7047-9			\$156.99	46					
	3 GHz	Passivated Stainless Steel	1.2:1	Yes	10		PE7047-10	\$169.52	47					
				Yes	12		PE7047-12	\$168.56	48					
				Yes	15		PE7047-15	\$180.59	49					
				Yes	20		PE7047-20	\$164.98	50					
				Yes	30		PE7047-30	\$164.98	51					
				Yes	40		PE7047-40	\$175.84	52					
6 GHz	Passivated Stainless Steel	1.35:1	Yes	3	PE70A1009	\$142.91	53							
			Yes	6	PE70A1011	\$151.25	54							
			Yes	9	PE70A1013	\$56.30	55							
			Yes	12	PE70A1014	\$56.30	56							
			Yes	16	PE70A1015	\$61.30	57							
			Yes	18	PE70A1016	\$56.30	58							
SMA Male	SMA Female	3 GHz	Passivated Stainless Steel	1.2:1	Yes	1	PE7001-1	\$94.17	59					
					Yes	2	PE7001-2	\$94.17	60					
					Yes	3	PE7001-3	\$84.04	61					
					Yes	4	PE7001-4	\$92.45	62					
					Yes	5	PE7001-5	\$96.76	63					
					Yes	6	PE7001-6	\$88.73	64					
					Yes	7	PE7001-7	\$96.76	65					
					Yes	8	PE7001-8	\$79.22	66					
					Yes	9	PE7001-9	\$88.73	67					
					Yes	10	PE7001-10	\$87.30	68					
					Yes	12	PE7001-12	\$88.73	69					
					Yes	15	PE7001-15	\$88.73	70					
6 GHz	Passivated Stainless Steel	1.35:1	Yes	20	PE7001-20	\$87.30	71							
			Yes	30	PE7001-30	\$88.73	72							
			Yes	40	PE7001-40	\$96.76	73							
			Yes	0	PE7091-0	\$39.84	74							
			Yes	1	PE7091-1	\$43.09	75							
			Yes	2	PE7091-2	\$47.64	76							
SMA Male	SMA Female	3 GHz	Passivated Stainless Steel	1.2:1	Yes	3	PE7091-3	\$39.84	77					
					Yes	4	PE7091-4	\$47.64	78					
					Yes	5	PE7091-5	\$48.50	79					
					Yes	6	PE7091-6	\$43.09	80					

* Bi-Dir is Bi-Directional. If No then Attenuator is Directional. Maximum power applies to input connector only.

Fixed Attenuators

50 Ohm



Max. Power (Watts)	Connector Input	Connector Output	Max. Freq.	Construction Material	VSWR Max.	Bi-Dir.*	ATTN. (dB)	Model No	1 Pc. Price	See Web for Volume Pricing	ROW
2 W	SMA Male	SMA Female	6 GHz	Passivated Stainless Steel	1.35:1	Yes	7	PE7091-7	\$47.64	See Web for Volume Pricing	29
						Yes	10	PE7091-10	\$43.27		
						Yes	12	PE7091-12	\$42.22		
						Yes	15	PE7091-15	\$42.22		
						Yes	20	PE7091-20	\$41.67		
						Yes	30	PE7091-30	\$43.30		
						Yes	40	PE7091-40	\$54.33		
						Yes	1	PE7162-1	\$51.15		
						Yes	2	PE7162-2	\$50.08		
						Yes	3	PE7162-3	\$36.62		
						Yes	4	PE7162-4	\$48.73		
						Yes	5	PE7162-5	\$49.80		
						Yes	6	PE7162-6	\$31.16		
						Yes	7	PE7162-7	\$46.02		
						Yes	8	PE7162-8	\$46.02		
						Yes	9	PE7162-9	\$44.67		
						Yes	10	PE7162-10	\$39.97		
						Yes	12	PE7162-12	\$44.67		
						Yes	15	PE7162-15	\$44.67		
						Yes	20	PE7162-20	\$36.84		
			Yes		30	PE7162-30	\$43.91				
			Yes		40	PE7162-40	\$51.15				
			Yes		1	PE7045-1	\$132.17				
			Yes		2	PE7045-2	\$128.64				
			Yes		3	PE7045-3	\$116.84				
			Yes		4	PE7045-4	\$118.01				
			Yes		5	PE7045-5	\$132.17				
			Yes		6	PE7045-6	\$120.05				
			Yes		7	PE7045-7	\$110.92				
			Yes		8	PE7045-8	\$99.04				
			Yes		9	PE7045-9	\$110.92				
			Yes		10	PE7045-10	\$115.61				
			Yes		12	PE7045-12	\$110.92				
			Yes		15	PE7045-15	\$120.05				
			Yes		20	PE7045-20	\$120.05				
			Yes		30	PE7045-30	\$120.05				
			Yes		40	PE7045-40	\$132.17				
			Yes		1	PE7005-1	\$69.28				
			Yes		2	PE7005-2	\$64.67				
			Yes		3	PE7005-3	\$63.04				
Yes	4	PE7005-4	\$77.28								
Yes	5	PE7005-5	\$70.57								
Yes	6	PE7005-6	\$66.72								
Yes	7	PE7005-7	\$76.66								
Yes	8	PE7005-8	\$76.66								
Yes	9	PE7005-9	\$72.73								
Yes	10	PE7005-10	\$63.04								
Yes	12	PE7005-12	\$72.73								
Yes	15	PE7005-15	\$67.35								
Yes	20	PE7005-20	\$65.72								
Yes	30	PE7005-30	\$63.98								
Yes	40	PE7005-40	\$74.57								
Yes	1	PE7092-1	\$48.50								
Yes	2	PE7092-2	\$48.50								
Yes	3	PE7092-3	\$43.27								
Yes	4	PE7092-4	\$49.81								
Yes	5	PE7092-5	\$49.58								
Yes	6	PE7092-6	\$43.27								
Yes	7	PE7092-7	\$48.72								
Yes	8	PE7092-8	\$48.72								
Yes	9	PE7092-9	\$42.22								
Yes	10	PE7092-10	\$43.27								
Yes	12	PE7092-12	\$42.22								
Yes	15	PE7092-15	\$43.09								
Yes	20	PE7092-20	\$43.27								
Yes	30	PE7092-30	\$43.09								
Yes	40	PE7092-40	\$63.33								
Yes	0	PE7087-0	\$103.68								
Yes	1	PE7087-1	\$116.67								
			26 GHz		1.4:1						34

Attenuators & Equalizers

See Our Website For Current Pricing & Real-Time Stock Availability!

* Bi-Dir is Bi-Directional. If No then Attenuator is Directional. Maximum power applies to input connector only.

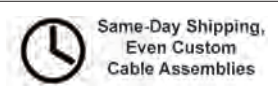

Fixed Attenuators

50 Ohm



Max. Power (Watts)	Connector Input	Connector Output	Max. Freq.	Construction Material	VSWR Max.	Bi-Dir.*	ATTN. (dB)	Model No	1 Pc. Price	See Web for Volume Pricing	ROW								
2 W	SMA Male	SMA Female	26 GHz	Passivated Stainless Steel	1.4:1	Yes	2	PE7087-2	\$116.67	See Web for Volume Pricing	34								
						Yes	3	PE7087-3	\$97.53										
						Yes	4	PE7087-4	\$115.63										
						Yes	5	PE7087-5	\$115.63										
						Yes	6	PE7087-6	\$102.18										
						Yes	7	PE7087-7	\$115.63										
						Yes	8	PE7087-8	\$115.63										
						Yes	9	PE7087-9	\$109.14										
						Yes	10	PE7087-10	\$102.18										
						Yes	12	PE7087-12	\$110.44										
						Yes	15	PE7087-15	\$116.67										
						Yes	20	PE7087-20	\$102.18										
						Yes	30	PE7087-30	\$102.18										
						Yes	2	PE7003-2	\$74.70										
						2 W	TNC Male	TNC Female	2 GHz			Nickel Plated Brass	1.15:1	Yes	3	PE7003-3	\$71.23	See Web for Volume Pricing	35
Yes	6	PE7003-6	\$79.78																
Yes	1	PE7051-1	\$175.84																
Yes	2	PE7051-2	\$175.84																
Yes	3	PE7051-3	\$156.51																
Yes	6	PE7051-6	\$161.02																
12.4 GHz	Nickel Plated Brass	1.25:1	Yes	10	PE7051-10				\$161.95										
			Yes	20	PE7051-20				\$179.50										
			Yes	30	PE7051-30				\$174.19										
			Yes	40	PE7051-40				\$161.32										
			18 GHz	Passivated Stainless Steel	1.35:1				Yes	1	PE7030-1	\$254.69							
									Yes	2	PE7030-2	\$291.23							
									Yes	3	PE7030-3	\$302.60							
									Yes	6	PE7030-6	\$302.60							
									Yes	10	PE7030-10	\$302.60							
Yes	20	PE7030-20				\$305.64													
5 W	7/16 DIN Male	7/16 DIN Female	7.5 GHz	Tri-Metal Plated Brass	1.25:1	Yes	1	PE7039-1	\$243.44	See Web for Volume Pricing	38								
						Yes	2	PE7039-2	\$204.29										
						Yes	3	PE7039-3	\$212.26										
						Yes	6	PE7039-6	\$212.26										
						Yes	10	PE7039-10	\$231.36										
						Yes	20	PE7039-20	\$212.26										
						5 W	N Male	N Female	3 GHz			Aluminum	1.2:1	Yes	30	PE7039-30	\$275.70	See Web for Volume Pricing	39
														Yes	1	PE7390-1	\$69.29		
														Yes	2	PE7390-2	\$69.29		
														Yes	3	PE7390-3	\$64.74		
														Yes	6	PE7390-6	\$64.74		
														Yes	10	PE7390-10	\$64.93		
									6 GHz			Black Anodized Aluminum Heatsink	1.25:1	Yes	15	PE7390-15	\$63.88		
														Yes	20	PE7390-20	\$64.74		
														Yes	30	PE7390-30	\$64.74		
	1	PE7AP006-01	\$108.37																
	2	PE7AP006-02	\$112.60																
	3	PE7AP006-03	\$107.18																
	4	PE7AP006-04	\$112.60																
	5	PE7AP006-05	\$112.60																
	6	PE7AP006-06	\$107.18																
	9	PE7AP006-09	\$103.99																
	10	PE7AP006-10	\$108.05																
	12	PE7AP006-12	\$103.99																
18 GHz	Black Anodized Aluminum Heatsink	1.4:1	Yes	15	PE7AP006-15	\$96.63													
			Yes	20	PE7AP006-20	\$134.03													
			Yes	30	PE7AP006-30	\$108.05													
			Yes	40	PE7AP006-40	\$118.87													
			Yes	1	PE7014-1	\$302.06													
			Yes	2	PE7014-2	\$302.06													
			Yes	3	PE7014-3	\$317.45													
			Yes	6	PE7014-6	\$317.45													
			Yes	10	PE7014-10	\$311.63													
			Yes	20	PE7014-20	\$317.45													
3 GHz	SMA Female	1.2:1	Yes	30	PE7014-30	\$311.63													
			Yes	40	PE7014-40	\$329.25													
			Yes	1	PE7391-1	\$67.13													
			Yes	2	PE7391-2	\$69.29													

* Bi-Dir is Bi-Directional. If No then Attenuator is Directional. Maximum power applies to input connector only.

Attenuators & Equalizers

See Our Website For Current Pricing & Real-Time Stock Availability!

Fixed Attenuators

50 Ohm



Max. Power (Watts)	Connector Input	Connector Output	Max. Freq.	Construction Material	VSWR Max.	Bi-Dir.*	ATTN. (dB)	Model No	1 Pc. Price	See Web for Volume Pricing	ROW
5 W	SMA Male	SMA Female	3 GHz	Black Anodized Aluminum Heatsink	1.2:1	Yes	3	PE7391-3	\$63.88	See Web for Volume Pricing	42
				Aluminum		Yes	6	PE7391-6	\$63.88		
				Black Anodized Aluminum Heatsink		Yes	10	PE7391-10	\$63.88		
				Aluminum		Yes	15	PE7391-15	\$63.88		
			18 GHz	Black Anodized Aluminum Heatsink	1.35:1	Yes	20	PE7391-20	\$64.74		
						Yes	30	PE7391-30	\$64.74		
						Yes	1	PE7013-1	\$179.03		
	Yes	2				PE7013-2	\$187.64				
	Yes	3				PE7013-3	\$168.67				
	Yes	6				PE7013-6	\$173.18				
	Yes	10				PE7013-10	\$168.87				
	TNC Male	TNC Female	18 GHz	Black Anodized Aluminum Heatsink	1.35:1	Yes	20	PE7013-20	\$173.53		43
						Yes	30	PE7013-30	\$168.67		
						Yes	40	PE7013-40	\$188.58		
Yes						1	PE7052-1	\$312.95			
Yes						2	PE7052-2	\$312.95			
Yes						3	PE7052-3	\$312.95			
Yes						6	PE7052-6	\$312.95			
Yes						10	PE7052-10	\$312.95			
Yes						20	PE7052-20	\$312.95			
Yes						30	PE7052-30	\$312.88			
10 W	2.92mm Male	2.92mm Female	40 GHz	1.5:1	No	10	PE7AP402-10	\$984.98	See Web for Volume Pricing	45	
					No	20	PE7AP402-20	\$984.98			
					Yes	3	PE7AP402-3	\$983.42			
					Yes	6	PE7AP402-6	\$968.88			
	7/16 DIN Male	7/16 DIN Female	7.5 GHz	1.45:1	No	30	PE7AP402-30	\$984.98		46	
					Yes	6	PE7040-6	\$301.97			
					Yes	10	PE7040-10	\$348.81			
	BNC Male	BNC Female	2 GHz	Black Anodized Aluminum Heatsink	1.6:1	Yes	20	PE7040-20		\$198.27	47
						Yes	30	PE7040-30		\$214.26	
						Yes	2	PE7025-2		\$323.71	
						Yes	3	PE7025-3		\$341.05	
						Yes	6	PE7025-6		\$325.40	
						Yes	10	PE7025-10		\$334.79	
						Yes	20	PE7025-20		\$334.79	
Yes						30	PE7025-30	\$319.13			
Yes						40	PE7025-40	\$352.85			
Yes						2	PE7010-2	\$237.10			
N Male	N Female	3 GHz	Black Anodized Aluminum Heatsink	1.2:1	Yes	3	PE7010-3	\$247.58	48		
					Yes	6	PE7010-6	\$247.58			
					Yes	10	PE7010-10	\$247.58			
					Yes	20	PE7010-20	\$247.58			
					Yes	30	PE7010-30	\$246.65			
					Yes	40	PE7010-40	\$206.20			
					Yes	3	PE7386-3	\$150.49			
		12.4 GHz	1.35:1	Yes	6	PE7386-6	\$150.49				
				Yes	10	PE7386-10	\$150.49				
				Yes	15	PE7386-15	\$123.74				
				Yes	20	PE7386-20	\$150.49				
				Yes	30	PE7386-30	\$150.49				
				Yes	40	PE7386-40	\$161.32				
				Yes	1	PE7048-1	\$392.71				
18 GHz	1.4:1	Yes	2	PE7048-2	\$392.71						
		Yes	3	PE7048-3	\$388.25						
		Yes	6	PE7048-6	\$386.75						
		Yes	10	PE7048-10	\$381.13						
		Yes	20	PE7048-20	\$381.70						
		Yes	30	PE7048-30	\$371.34						
		Yes	40	PE7048-40	\$381.70						
18 GHz	1.4:1	Yes	1	PE7015-1	\$302.04	50					
		Yes	2	PE7015-2	\$311.19						
		Yes	3	PE7015-3	\$381.70						
		Yes	6	PE7015-6	\$382.60						
		Yes	10	PE7015-10	\$381.70						
		Yes	20	PE7015-20	\$375.25						

Attenuators & Equalizers

See Our Website For Current Pricing & Real-Time Stock Availability!

* Bi-Dir is Bi-Directional. If No then Attenuator is Directional. Maximum power applies to input connector only.

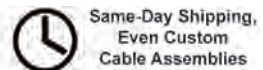
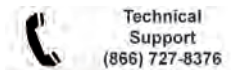

Fixed Attenuators

50 Ohm



Attenuators & Equalizers

See Our Website For Current Pricing & Real-Time Stock Availability!

Max. Power (Watts)	Connector Input	Connector Output	Max. Freq.	Construction Material	VSWR Max.	Bi-Dir.*	ATTN. (dB)	Model No	1 Pc. Price	See Web for Volume Pricing	ROW												
10 W	N Male	N Female	18 GHz	Black Anodized Aluminum Heatsink	1.4:1	Yes	30	PE7015-30	\$382.60	See Web for Volume Pricing	51												
			6 GHz			Yes	40	PE7015-40	\$392.96		52												
	SMA Male	SMA Female	18 GHz		1.2:1	Yes	10	PE7428-10	\$163.51		1.4:1	Yes	1	PE7016-1	\$381.13	53							
						Yes	2	PE7016-2	\$348.30														
					Yes	3	PE7016-3	\$360.08															
					Yes	6	PE7016-6	\$353.16															
					Yes	10	PE7016-10	\$351.62															
					Yes	20	PE7016-20	\$353.34															
					Yes	30	PE7016-30	\$360.08															
					Yes	40	PE7016-40	\$381.70															
	TNC Male	TNC Female	18 GHz		1.4:1	Yes	1	PE7053-1	\$408.65		1.4:1	Yes	2	PE7053-2	\$408.65	54							
						Yes	2	PE7053-2	\$408.65														
						Yes	3	PE7053-3	\$465.19														
						Yes	6	PE7053-6	\$436.86														
Yes				10		PE7053-10	\$465.19																
Yes				20		PE7053-20	\$493.53																
15 W	4.3-10 Male	4.3-10 Female	6 GHz	Aluminum	1.15:1	Yes	10	PE7AP1001-10	\$295.93	See Web for Volume Pricing	55												
							3	PE7AP1001-3	\$295.93														
							6	PE7AP1001-6	\$295.93														
							20	PE7AP1001-20	\$295.93														
							25 W	7/16 DIN Male	7/16 DIN Female			6 GHz	Black Anodized Aluminum Heatsink	1.3:1	Yes	50	PE7379-50	\$455.66	See Web for Volume Pricing	56			
																3	PE7041-3	\$476.79			1.45:1		
																6	PE7041-6	\$476.79					
																10	PE7041-10	\$594.47					
																20	PE7041-20	\$412.49					
																30	PE7041-30	\$476.79					
10	PE7379-10	\$595.95																					
7/16 DIN Female	7/16 DIN Female	7.5 GHz	1.45:1	Yes	20	PE7379-20		\$477.98	1.45:1	Yes	20	PE7379-20		\$455.66	58								
					Yes	30		PE7379-30		\$455.66													
					Yes	40		PE7379-40		\$455.66													
					Yes	3		PE7379-3		\$455.66													
					Yes	6		PE7379-6		\$455.66													
					N Male	N Female		6 GHz		1.3:1	Yes	50		PE7380-50		\$462.25	1.3:1	Yes		3	PE7380-3	\$462.25	59
												Yes		3		PE7380-3		\$462.25					
Yes	6	PE7380-6	\$462.25																				
Yes	10	PE7380-10	\$462.25																				
Yes	20	PE7380-20	\$462.25																				
Yes	30	PE7380-30	\$462.25																				
Yes	40	PE7380-40	\$462.25																				
N Male	N Female	7.5 GHz	Black Anodized Aluminum Heatsink	1.3:1	Yes	50	PE7366-50	\$403.39	See Web for Volume Pricing	60													
						Yes	10	PE7366-10			\$403.39												
						Yes	20	PE7366-20			\$403.39												
						Yes	30	PE7366-30			\$419.12												
						Yes	40	PE7366-40			\$419.12												
						Yes	3	PE7366-3			\$403.39												
						Yes	6	PE7366-6			\$403.39												
				4 GHz	N Female	4 GHz	1.25:1	Yes		1	PE7392-1	\$215.45	1.25:1	Yes	1	PE7392-1	\$215.45	61					
										Yes	2	PE7392-2		\$215.45									
										Yes	3	PE7392-3		\$202.01									
										Yes	6	PE7392-6		\$204.62									
										Yes	10	PE7392-10		\$204.62									
										Yes	20	PE7392-20		\$205.48									
										Yes	30	PE7392-30		\$205.48									
18 GHz	N Female	18 GHz	Black Anodized Aluminum Heatsink	1.6:1	Yes	50	PE7367-50	\$464.45	See Web for Volume Pricing	62													
						Yes	1	PE7017-1			\$558.98												
						Yes	2	PE7017-2			\$635.21												
						Yes	3	PE7017-3			\$558.98												
						Yes	6	PE7017-6			\$554.84												
				1.4:1	Yes	10	PE7017-10	\$558.98															
						Yes	20	PE7017-20		\$558.98													
						Yes	30	PE7017-30		\$558.98													
						Yes	40	PE7017-40		\$648.29													
						Yes	10	PE7367-10		\$460.00													
1.6:1	Yes	18 GHz	Black Anodized Aluminum Heatsink	1.6:1	Yes	20	PE7367-20	\$460.00	See Web for Volume Pricing	63													
						Yes	30	PE7367-30			\$448.78												
						Yes	40	PE7367-40			\$464.45												
						Yes	20	PE7367-20			\$460.00												
						Yes	30	PE7367-30			\$448.78												
Yes	40	PE7367-40	\$464.45																				

* Bi-Dir is Bi-Directional. If No then Attenuator is Directional. Maximum power applies to input connector only.

Fixed Attenuators

50 Ohm



Max. Power (Watts)	Connector Input	Connector Output	Max. Freq.	Construction Material	VSWR Max.	Bi-Dir.*	ATTN. (dB)	Model No	1 Pc. Price	See Web for Volume Pricing	ROW	
25 W	N Male	N Female	18 GHz	Black Anodized Aluminum Heatsink	1.6:1	Yes	3	PE7367-3	\$460.00	See Web for Volume Pricing	64	
			6 GHz		1.3:1	Yes	6	PE7367-6	\$460.00		65	
	7.5 GHz	7/16 DIN Male	1.45:1		Yes	50	PE7370-50	\$395.41	65			
			Yes		3	PE7370-3	\$395.41	65				
			Yes		6	PE7370-6	\$395.41	65				
			Yes		10	PE7370-10	\$395.41	65				
			Yes		20	PE7370-20	\$395.41	65				
			Yes		30	PE7370-30	\$395.41	65				
	7.5 GHz	7/16 DIN Female	1.3:1		Yes	50	PE7369-50	\$402.00	66			
			1.45:1		Yes	10	PE7369-10	\$402.00	66			
			Yes		20	PE7369-20	\$402.00	66				
			Yes		30	PE7369-30	\$402.00	66				
			Yes		40	PE7369-40	\$402.00	66				
			Yes		3	PE7369-3	\$402.00	66				
	18 GHz	N Female	1.6:1		Yes	50	PE7371-50	\$372.53	67			
			1.45:1		Yes	10	PE7371-10	\$436.83	67			
			Yes		3	PE7371-3	\$436.83	67				
			Yes		6	PE7371-6	\$436.83	67				
			Yes		20	PE7371-20	\$436.31	67				
			Yes		30	PE7371-30	\$436.31	67				
	TNC Female	N Female	1.6:1		Yes	40	PE7371-40	\$453.63	68			
			Yes		30	PE7372-30	\$386.01	68				
	SMA Male	SMA Female	4 GHz		1.25:1	Yes	3	PE7393-3	\$159.07		69	
					Yes	10	PE7393-10	\$195.66	69			
					Yes	20	PE7393-20	\$195.66	69			
					Yes	30	PE7393-30	\$195.66	69			
					Yes	40	PE7393-40	\$215.45	69			
					Yes	50	PE7357-50	\$343.45	70			
					6 GHz	1.4:1	Yes	1	PE7018-1		\$540.24	70
							Yes	2	PE7018-2		\$540.24	70
							Yes	3	PE7018-3		\$616.32	70
							Yes	6	PE7018-6		\$616.32	70
							Yes	10	PE7018-10		\$616.32	70
							Yes	20	PE7018-20		\$542.36	70
			18 GHz		1.6:1	Yes	30	PE7018-30	\$616.32		70	
						Yes	40	PE7018-40	\$648.29		70	
						Yes	10	PE7357-10	\$422.45		71	
						Yes	20	PE7357-20	\$343.45		71	
						Yes	30	PE7357-30	\$422.45		71	
						Yes	40	PE7357-40	\$431.97		71	
						Yes	3	PE7357-3	\$422.45		71	
						Yes	6	PE7357-6	\$327.42		71	
						Yes	10	PE7363-10	\$418.81		71	
						Yes	20	PE7363-20	\$418.81		71	
						Yes	30	PE7363-30	\$418.81		71	
						Yes	6	PE7363-6	\$418.81		71	
	TNC Male	TNC Female	1.4:1		Yes	40	PE7363-40	\$453.63	71			
					Yes	1	PE7054-1	\$585.78	72			
Yes				2	PE7054-2	\$585.78	72					
Yes				3	PE7054-3	\$585.78	72					
Yes				10	PE7054-10	\$775.78	72					
Yes				20	PE7054-20	\$745.94	72					
1.6:1			Yes	30	PE7054-30	\$745.94	72					
			Yes	40	PE7054-40	\$636.90	72					
			Yes	20	PE7375-20	\$404.08	72					
			Yes	30	PE7375-30	\$385.21	72					
			Yes	40	PE7375-40	\$399.49	72					
			Yes	50	PE7312-50	\$503.28	72					
SMA Female	SMA Female	6 GHz	1.3:1	No	10	PE7042-10	\$679.37	73				
				No	20	PE7042-20	\$544.89	73				
				No	30	PE7042-30	\$626.85	73				
				No	40	PE7042-40	\$457.42	73				
				No	3	PE7312-3	\$527.96	73				
				No	6	PE7312-6	\$503.28	73				
		7.5 GHz	1.45:1	No	10	PE7312-10	\$527.96	73				
				No	20	PE7312-20	\$522.91	73				
				No	10	PE7042-10	\$679.37	74				
				No	20	PE7042-20	\$544.89	74				
				No	30	PE7042-30	\$626.85	74				
				No	40	PE7042-40	\$457.42	74				
TNC Male	TNC Female	6 GHz	1.3:1	No	3	PE7312-3	\$527.96	75				
				No	6	PE7312-6	\$503.28	75				
				No	10	PE7312-10	\$527.96	75				
				No	20	PE7312-20	\$522.91	75				
				No	10	PE7042-10	\$679.37	76				
				No	20	PE7042-20	\$544.89	76				
		7.5 GHz	1.45:1	No	30	PE7042-30	\$626.85	76				
				No	40	PE7042-40	\$457.42	76				
				No	3	PE7312-3	\$527.96	77				
				No	6	PE7312-6	\$503.28	77				
				No	10	PE7312-10	\$527.96	77				
				No	20	PE7312-20	\$522.91	77				
7/16 DIN Male	7/16 DIN Female	6 GHz	1.3:1	No	50	PE7312-50	\$503.28	78				
				No	10	PE7042-10	\$679.37	78				
				No	20	PE7042-20	\$544.89	78				
				No	30	PE7042-30	\$626.85	78				
				No	40	PE7042-40	\$457.42	78				
				No	3	PE7312-3	\$527.96	78				
		7.5 GHz	1.45:1	No	6	PE7312-6	\$503.28	78				
				No	10	PE7312-10	\$527.96	78				
				No	20	PE7312-20	\$522.91	78				
				No	10	PE7042-10	\$679.37	78				
				No	20	PE7042-20	\$544.89	78				
				No	30	PE7042-30	\$626.85	78				

Attenuators & Equalizers

See Our Website For Current Pricing & Real-Time Stock Availability!

* Bi-Dir is Bi-Directional. If No then Attenuator is Directional. Maximum power applies to input connector only.

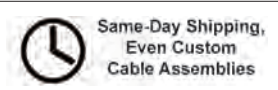
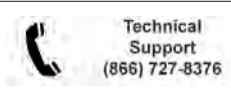

Fixed Attenuators

50 Ohm



Max. Power (Watts)	Connector Input	Connector Output	Max. Freq.	Construction Material	VSWR Max.	Bi-Dir.*	ATTN. (dB)	Model No	1 Pc. Price	See Web for Volume Pricing	ROW
50 W	7/16 DIN Male	7/16 DIN Female	7.5 GHz	Black Anodized Aluminum Heatsink	1.45:1	No	30	PE7312-30	\$503.28	See Web for Volume Pricing	78
						No	40	PE7312-40	\$503.28		
	7/16 DIN Male	7/16 DIN Female	7.5 GHz		1.3:1	No	50	PE7310-50	\$503.28		79
						No	3	PE7310-3	\$527.96		
					1.45:1	No	6	PE7310-6	\$503.28		
						No	10	PE7310-10	\$527.96		
						No	20	PE7310-20	\$503.28		
						No	30	PE7310-30	\$503.28		
	1.3:1	No	40		PE7310-40	\$503.28					
		No	50		PE7313-50	\$509.90					
7/16 DIN Female	7/16 DIN Female	7.5 GHz	1.3:1	No	3	PE7313-3	\$509.90	80			
				No	6	PE7313-6	\$593.36				
			1.45:1	No	10	PE7313-10	\$509.90				
				No	20	PE7313-20	\$509.90				
				No	30	PE7313-30	\$509.90				
				No	40	PE7313-40	\$593.36				
1.3:1	No	50	PE7316-50	\$473.11							
	No	50	PE7321-50	\$449.68							
N Female	N Female	6 GHz	1.3:1	No	3	PE7316-3	\$451.01	81			
				No	6	PE7316-6	\$451.01				
		7.5 GHz	1.45:1	No	10	PE7316-10	\$451.01		83		
				No	20	PE7316-20	\$451.01				
	N Female	N Female	7.5 GHz	1.45:1	No	30	PE7316-30	\$451.01	84		
					No	40	PE7316-40	\$451.01			
				1.6:1	No	3	PE7321-3	\$449.68			
					No	6	PE7321-6	\$449.68			
					No	10	PE7321-10	\$449.68			
					No	20	PE7321-20	\$449.68			
N Male	7/16 DIN Female	6 GHz	1.3:1	No	50	PE7314-50	\$451.01	85			
				No	3	PE7314-3	\$451.01				
		7.5 GHz	1.45:1	No	6	PE7314-6	\$451.01				
				No	10	PE7314-10	\$451.01				
				No	20	PE7314-20	\$451.01				
				No	30	PE7314-30	\$451.01				
	N Female	N Female	3 GHz	1.15:1	No	40	PE7314-40	\$451.01	86		
					No	3	PE7388-3	\$258.35			
					No	6	PE7388-6	\$258.35			
					No	10	PE7388-10	\$265.01			
No					15	PE7388-15	\$265.01				
No					20	PE7388-20	\$266.07				
No					30	PE7388-30	\$255.98				
No					40	PE7388-40	\$284.52				
Yes					3	PE7389-3	\$226.27				
Yes					6	PE7389-6	\$226.27				
Yes	10	PE7389-10	\$226.27								
Yes	15	PE7389-15	\$226.27								
Yes	20	PE7389-20	\$227.14								
Yes	30	PE7389-30	\$227.14								
Yes	40	PE7389-40	\$237.96								
N Female	N Female	4 GHz	1.35:1	Yes	2	PE7394-2	\$297.73	88			
				Yes	3	PE7394-3	\$346.77				
				Yes	6	PE7394-6	\$281.92				
				Yes	10	PE7394-10	\$281.92				
				Yes	30	PE7394-30	\$296.31				
				Yes	40	PE7394-40	\$298.53				
6 GHz	1.3:1	No	50	PE7322-50	\$473.23	89					
		No	6	PE7019-6	\$610.84						
18 GHz	1.45:1	No	10	PE7019-10	\$670.63	90					
		No	20	PE7019-20	\$650.83						
		No	30	PE7019-30	\$629.41						
		No	40	PE7019-40	\$651.93						
		1.6:1	No	3	PE7322-3		\$540.24	91			
			No	6	PE7322-6		\$540.24				
N Female	N Female	18 GHz	1.6:1	No	10	PE7322-10	\$540.24				
				No	20	PE7322-20	\$627.33				
N Female	N Female	18 GHz	1.6:1	No	30	PE7322-30	\$540.24				
				No	30	PE7322-30	\$540.24				

* Bi-Dir is Bi-Directional. If No then Attenuator is Directional. Maximum power applies to input connector only.

Attenuators & Equalizers

See Our Website For Current Pricing & Real-Time Stock Availability!

Fixed Attenuators

50 Ohm



Max. Power (Watts)	Connector Input	Connector Output	Max. Freq.	Construction Material	VSWR Max.	Bi-Dir.*	ATTN. (dB)	Model No	1 Pc. Price	See Web for Volume Pricing	ROW	
50 W	N Male	N Female	18 GHz	Black Anodized Aluminum Heatsink	1.6:1	No	40	PE7322-40	\$473.23	See Web for Volume Pricing	91	
			6 GHz				1.3:1	No	50		PE7311-50	\$460.35
	7/16 DIN Male	7.5 GHz	1.45:1		No	3	PE7311-3	\$443.07	93			
					No	6	PE7311-6	\$443.07				
					No	10	PE7311-10	\$443.07				
					No	20	PE7311-20	\$460.35				
					No	30	PE7311-30	\$460.35				
					No	40	PE7311-40	\$443.07				
	7/16 DIN Female	7.5 GHz	1.45:1		1.3:1	No	50	PE7315-50	\$449.68		94	
						No	3	PE7315-3	\$449.68			
						No	6	PE7315-6	\$449.68			
						No	10	PE7315-10	\$449.68			
						No	20	PE7315-20	\$449.68			
						No	30	PE7315-30	\$449.68			
	N Female	N Male	18 GHz		1.6:1	1.3:1	No	50	PE7317-50		\$557.56	95
							No	3	PE7317-3		\$540.24	
							No	6	PE7317-6		\$540.24	
							No	10	PE7317-10		\$540.24	
							No	20	PE7317-20		\$559.88	
							No	30	PE7317-30		\$540.24	
	SMA Male	SMA Female	18 GHz		1.6:1	1.3:1	No	40	PE7317-40		\$551.06	96
							No	50	PE7323-50		\$449.61	
							No	3	PE7323-3		\$471.64	
							No	6	PE7323-6		\$471.64	
							No	10	PE7323-10		\$545.91	
							No	20	PE7323-20		\$626.48	
							No	30	PE7323-30		\$548.49	
							No	40	PE7323-40		\$551.06	
							No	6	PE7020-6		\$726.24	
							No	10	PE7020-10		\$726.24	
							No	20	PE7020-20		\$648.15	
							No	30	PE7020-30		\$641.31	
SMA Female	SMA Female	18 GHz	1.35:1	1.45:1	No	40	PE7020-40	\$639.39	97			
					Yes	3	PE7427-03	\$549.63				
					Yes	6	PE7427-06	\$549.63				
					Yes	10	PE7427-10	\$549.63				
					Yes	10	PE7427-30-10	Call				
					Yes	15	PE7427-15	\$529.00				
					Yes	20	PE7427-20	\$549.63				
					Yes	30	PE7427-30	\$549.63				
TNC Male	TNC Female	18 GHz	1.6:1	1.45:1	Yes	40	PE7427-40	\$529.00	98			
					No	6	PE7337-6	\$523.24				
					No	10	PE7337-10	\$523.24				
					No	20	PE7337-20	\$523.24				
					No	30	PE7337-30	\$523.24				
					No	40	PE7337-40	\$529.41				
TNC Female	TNC Female	18 GHz	1.6:1	1.45:1	No	50	PE7337-50	\$622.36	99			
					No	10	PE7055-10	\$1,011.86				
					No	20	PE7055-20	\$843.22				
					No	30	PE7055-30	\$789.25				
					No	40	PE7055-40	\$765.40				
					No	10	PE7351-10	\$501.57				
7/16 DIN Male	7/16 DIN Female	1.5 GHz	1.45:1	1.25:1	No	10	PE7043-10	\$699.00	1			
					No	20	PE7043-20	\$612.99				
					No	30	PE7043-30	\$612.99				
					No	3	PE7203-3	\$839.46				
					No	6	PE7203-6	\$807.95				
		6 GHz		No	10	PE7203-10	\$839.46					
				No	20	PE7203-20	\$880.60					
				No	30	PE7203-30	\$807.95					
				No	40	PE7203-40	\$897.08					
				No	50	PE7203-50	\$897.08					
N Female	N Female	6 GHz	1.6:1	No	60	PE7203-60	\$987.37	2				
				No	3	PE7211-3	\$739.16					
				No	3	PE7211-3	\$739.16					
100 W	7/16 DIN Male	7/16 DIN Female	6 GHz	Black Anodized Aluminum Heatsink	1.45:1	No	10	PE7043-10	\$699.00	3		
							20	PE7043-20	\$612.99			
							30	PE7043-30	\$612.99			
							3	PE7203-3	\$839.46			
							6	PE7203-6	\$807.95			
							10	PE7203-10	\$839.46			
							20	PE7203-20	\$880.60			
							30	PE7203-30	\$807.95			
							40	PE7203-40	\$897.08			
							50	PE7203-50	\$897.08			
N Female	N Female	6 GHz	1.6:1	No	3	No	PE7211-3	\$739.16	4			

* Bi-Dir is Bi-Directional. If No then Attenuator is Directional. Maximum power applies to input connector only.

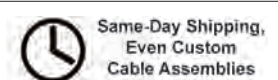

Attenuators & Equalizers

See Our Website For Current Pricing & Real-Time Stock Availability!

Fixed Attenuators

50 Ohm



Attenuators & Equalizers

See Our Website For Current Pricing & Real-Time Stock Availability!

Max. Power (Watts)	Connector Input	Connector Output	Max. Freq.	Construction Material	VSWR Max.	Bi-Dir.*	ATTN. (dB)	Model No	1 Pc. Price	See Web for Volume Pricing	ROW
100 W	7/16 DIN Male	N Female	6 GHz	Black Anodized Aluminum Heatsink	1.45:1	No	6	PE7211-6	\$739.16	See Web for Volume Pricing	4
						No	10	PE7211-10	\$739.16		
						No	20	PE7211-20	\$739.16		
						No	30	PE7211-30	\$775.39		
						No	40	PE7211-40	\$963.78		
						No	50	PE7211-50	\$963.78		
	No	60				PE7211-60	\$794.56	5			
	No	3				PE7201-3	\$807.95				
	No	6				PE7201-6	\$807.95				
	No	10				PE7201-10	\$839.46				
	No	20				PE7201-20	\$847.55				
	No	30				PE7201-30	\$807.95				
	No	40				PE7201-40	\$863.41				
	No	50				PE7201-50	\$863.41				
	No	60				PE7201-60	\$863.41				
	No	3				PE7204-3	\$815.52				
	No	6				PE7204-6	\$815.52		6		
	No	10				PE7204-10	\$815.52				
	No	20				PE7204-20	\$815.52				
	No	30				PE7204-30	\$815.52				
	No	40				PE7204-40	\$870.97				
	No	50				PE7204-50	\$870.97				
	No	60				PE7204-60	\$870.97	7			
	No	3				PE7207-3	\$748.22				
	No	6				PE7207-6	\$748.22				
	No	10				PE7207-10	\$748.22				
	No	20				PE7207-20	\$748.22				
	No	30				PE7207-30	\$748.22				
	No	40				PE7207-40	\$803.68				
	No	50				PE7207-50	\$803.68				
	No	60				PE7207-60	\$803.68	8			
	No	3				PE7212-3	\$746.72				
	No	6				PE7212-6	\$746.72				
	No	10				PE7212-10	\$746.72				
	No	20				PE7212-20	\$746.72				
	No	30				PE7212-30	\$746.72				
	No	40				PE7212-40	\$802.13				
	No	50				PE7212-50	\$802.13				
	No	60				PE7212-60	\$802.13	9			
	No	3				PE7026-3	\$871.85				
	No	6				PE7026-6	\$881.07				
	No	10				PE7026-10	\$778.43				
No	20	PE7026-20	\$881.07								
No	30	PE7026-30	\$810.90								
No	40	PE7026-40	\$881.07	10							
No	3	PE7205-3	\$748.22								
No	6	PE7205-6	\$748.22								
No	10	PE7205-10	\$748.22								
No	20	PE7205-20	\$748.22								
No	30	PE7205-30	\$748.22								
No	40	PE7205-40	\$803.68								
No	50	PE7205-50	\$803.68								
No	60	PE7205-60	\$803.68	11							
No	6	PE7021-6	\$882.34								
No	10	PE7021-10	\$753.26								
No	20	PE7021-20	\$738.78								
No	30	PE7021-30	\$911.72								
No	40	PE7021-40	\$794.01								
Yes	3	PE7385-3	\$453.63	12							
Yes	6	PE7385-6	\$453.63								
Yes	10	PE7385-10	\$453.63								
Yes	20	PE7385-20	\$453.63								
Yes	30	PE7385-30	\$453.63								
Yes	40	PE7385-40	\$464.45								
Yes	3	PE7421-3	\$529.41	13							
Yes	6	PE7421-6	\$529.41								
Yes	10	PE7421-10	\$540.24								
Yes	20	PE7421-20	\$541.10								
Yes	30	PE7421-30	\$572.72								
Yes	40	PE7421-40	\$572.72								

* Bi-Dir is Bi-Directional. If No then Attenuator is Directional. Maximum power applies to input connector only.

Fixed Attenuators

50 Ohm



Max. Power (Watts)	Connector Input	Connector Output	Max. Freq.	Construction Material	VSWR Max.	Bi-Dir.*	ATTN. (dB)	Model No	1 Pc. Price	See Web for Volume Pricing	ROW	
100 W	N Male	N Female	4 GHz	Black Anodized Aluminum Heatsink	1.2:1	No	40	PE7421-40	\$662.35	See Web for Volume Pricing	13	
						No	3	PE7213-3	\$705.93		14	
						No	6	PE7213-6	\$768.24		15	
						No	10	PE7213-10	\$793.06		16	
						No	20	PE7213-20	\$797.72		17	
						No	30	PE7213-30	\$780.74		18	
						No	40	PE7213-40	\$808.59		19	
						No	50	PE7213-50	\$824.12		20	
						No	60	PE7213-60	\$800.88		21	
						No	30	PE7237-30	\$720.59		22	
	N Female	TNC Female	7/16 DIN Male		6 GHz	1.45:1	No	3	PE7202-3		\$739.16	13
							No	6	PE7202-6		\$739.16	14
							No	10	PE7202-10		\$739.16	15
							No	20	PE7202-20		\$739.16	16
							No	30	PE7202-30		\$767.99	17
							No	40	PE7202-40		\$794.56	18
							No	50	PE7202-50		\$794.56	19
							No	60	PE7202-60		\$794.56	20
							No	3	PE7206-3		\$868.95	21
							No	6	PE7206-6		\$746.72	22
		No	10		PE7206-10	\$746.72	23					
		No	20		PE7206-20	\$868.96	24					
		No	30		PE7206-30	\$746.72	25					
		No	40		PE7206-40	\$802.13	26					
		No	50		PE7206-50	\$802.13	27					
		No	60		PE7206-60	\$802.13	28					
		No	3		PE7208-3	\$740.52	29					
		No	6		PE7208-6	\$790.65	30					
		No	10		PE7208-10	\$740.52	31					
		No	20		PE7208-20	\$793.06	32					
		No	30		PE7208-30	\$761.44	33					
		No	40		PE7208-40	\$808.59	34					
		No	50		PE7208-50	\$800.88	35					
		No	60		PE7208-60	\$800.88	36					
		No	3		PE7214-3	\$784.36	37					
		No	6		PE7214-6	\$768.54	38					
		No	10		PE7214-10	\$776.66	39					
		No	20		PE7214-20	\$784.36	40					
		No	30		PE7214-30	\$784.36	41					
		No	40		PE7214-40	\$799.26	42					
No	50	PE7214-50	\$829.38	43								
No	60	PE7214-60	\$810.94	44								
SMA Male	SMA Female	1.5 GHz	1.25:1	No	6	PE7022-6	\$871.85	13				
				No	10	PE7022-10	Call	14				
				No	20	PE7022-20	\$590.57	15				
				No	30	PE7022-30	\$872.76	16				
				No	40	PE7022-40	\$806.77	17				
				No	50	PE7227-50	\$730.23	18				
				No	60	PE7227-60	\$792.77	19				
				SMA Female	SMA Male	6 GHz	1.45:1	No	3	PE7221-3	\$679.16	20
								No	6	PE7221-6	\$705.65	21
								No	10	PE7221-10	\$705.65	22
No	20	PE7221-20	\$705.65					23				

Attenuators & Equalizers

See Our Website For Current Pricing & Real-Time Stock Availability!

* Bi-Dir is Bi-Directional. If No then Attenuator is Directional. Maximum power applies to input connector only.

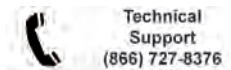

Fixed Attenuators

50 Ohm



Max. Power (Watts)	Connector Input	Connector Output	Max. Freq.	Construction Material	VSWR Max.	Bi-Dir.*	ATTN. (dB)	Model No	1 Pc. Price	See Web for Volume Pricing				ROW	
100 W	SMA Female	SMA Male	6 GHz	Black Anodized Aluminum Heatsink	1.45:1	No	40	PE7221-40	\$766.01	See Web for Volume Pricing				22	
		SMA Female				No	50	PE7221-50	\$737.26					23	
						No	60	PE7221-60	\$792.77					24	
						No	3	PE7228-3	\$702.25						
						No	20	PE7228-20	\$749.76						
						No	30	PE7228-30	\$786.52						
	TNC Male	TNC Female	1.5 GHz			1.15:1	No	30	PE7056-30					\$849.12	25
	TNC Female	N Male	6 GHz			1.45:1	No	30	PE7210-30					\$693.54	
		N Female					No	3	PE7218-3					\$692.02	
	150 W	N Male	N Female			8 GHz	Black Anodized Aluminum Heatsink	1.5:1	No					3	PE7AP150-03
No				6	PE7AP150-06				\$686.68						
No				10	PE7AP150-10				\$713.46						
No				20	PE7AP150-20				\$713.46						
No				30	PE7AP150-30				\$713.46						
200 W	N Male	N Female	3 GHz	Black Anodized Aluminum Heatsink	1.35:1	No	10	PE7387-10	\$643.09	See Web for Volume Pricing				28	
						No	20	PE7387-20	\$648.50						
						No	30	PE7387-30	\$649.36						
						No	40	PE7387-40	\$670.87						
300 W	N Male	N Female	1,000 MHz	Black Anodized Aluminum Heatsink	1.4:1	No	3	PE7031-3	\$2,038.52	See Web for Volume Pricing				29	
						No	6	PE7031-6	\$1,764.10						
						No	10	PE7031-10	\$1,832.90						
						No	20	PE7031-20	\$1,906.21						
	N Female	3 GHz	Black Aluminum Heatsink	No	3-3	PE7411-3	\$1,166.86	30							
500 W	N Male	N Female	1,000 MHz	Black Anodized Aluminum Heatsink	1.15:1	No	6	PE7032-6	\$2,230.24	See Web for Volume Pricing				31	
						No	30	PE7032-30	\$2,230.24						
			2.4 GHz		1.35:1	No	30	PE7084-30	\$928.68					32	
						No	2	PE7085-2	\$2,380.72					33	
1000 W	N Male	N Female	2.5 GHz	Black Aluminum Heatsink	1.35:1	No	10-10	PE7085-10	\$2,380.72	See Web for Volume Pricing					33
						No	30-30	PE7423-30	\$3,808.57					34	
						No	40	PE7423-40	\$3,808.57						

75 Ohm



Max. Power (Watts)	Connector Input	Connector Output	Max. Freq.	Construction Material	VSWR Max.	Bi-Dir.*	ATTN. (dB)	Model No	1-24	25-49	50-99	100+	ROW
1 W	BNC Male	BNC Female	1,000 MHz	Nickel Plated Brass	1.2:1	Yes	1	PE7009-1	\$65.49	\$62.22	\$58.94	\$56.32	35
						Yes	2	PE7009-2	\$65.49	\$62.22	\$58.94	\$56.32	
						Yes	3	PE7009-3	\$59.42	\$56.45	\$53.48	\$51.10	
						Yes	6	PE7009-6	\$60.39	\$57.37	\$54.35	\$51.94	

* Bi-Dir is Bi-Directional. If No then Attenuator is Directional. Maximum power applies to input connector only.

Attenuators & Equalizers

See Our Website For Current Pricing & Real-Time Stock Availability!

75 Ohm



Max. Power (Watts)	Connector Input	Connector Output	Max. Freq.	Construction Material	VSWR Max.	Bi-Dir.*	ATTN. (dB)	Model No	1 Pc. Price	See Web for Volume Pricing	ROW				
1 W	BNC Male	BNC Female	1,000 MHz	Nickel Plated Brass	1.2:1	Yes	10	PE7009-10	\$59.42	See Web for Volume Pricing	35				
						Yes	20	PE7009-20	\$59.42						
	Yes	30				PE7009-30	\$59.42								
	Yes	1				PE7029-1	\$68.08								
	Yes	3				PE7029-3	\$79.22								
	Yes	6				PE7029-6	\$79.22								
	Yes	10				PE7029-10	\$88.73								
	Yes	20				PE7029-20	\$70.74								
	Yes	30				PE7029-30	\$81.20								
	2 W	BNC Male				BNC Female	4 GHz	Nickel Plated Brass	1.35:1			Yes	1	PE7050-1	\$139.66
Yes			2	PE7050-2	\$139.66										
Yes			3	PE7050-3	\$128.84										
Yes			6	PE7050-6	\$128.84										
Yes			10	PE7050-10	\$154.60										
Yes			20	PE7050-20	\$154.60										
Yes			30	PE7050-30	\$128.84										
Yes			1	PE7057-1	\$88.44										
Yes			2	PE7057-2	\$88.44										
Yes			3	PE7057-3	\$116.01										
Yes		6	PE7057-6	\$116.01											
Yes		10	PE7057-10	\$118.01											
		1	PE7396-1	\$74.70											
		2	PE7396-2	\$74.70											
		3	PE7396-3	\$70.15											
		4	PE7396-4	\$89.64											
		5	PE7396-5	\$89.64											
		6	PE7396-6	\$69.29											
		7	PE7396-7	\$89.64											
		8	PE7396-8	\$89.64											
		9	PE7396-9	\$83.15											
		10	PE7396-10	\$70.15											
		16	PE7396-16	\$89.64											
		20	PE7396-20	\$69.29											
		Yes	1	PE7044-1	\$161.32										
		Yes	2	PE7044-2	\$161.32										
		Yes	3	PE7044-3	\$158.92										
		Yes	6	PE7044-6	\$180.59										
		Yes	10	PE7044-10	\$158.92										
		Yes	20	PE7044-20	\$158.92										
	Yes	30	PE7044-30	\$158.92											
	F Male	F Female	1,000 MHz	Tri-Metal Plated Brass	1.3:1										
	N Male	N Female	4 GHz	Passivated Stainless Steel											

Attenuators & Equalizers

See Our Website For Current Pricing & Real-Time Stock Availability!

Step Attenuators, Push Button

50 Ohm



Max. Power (Watts)	Conn. Input	Conn. Output	Frequency Range (MHz)	Construction Material	VSWR Max. (MHz)	ATTN. Range (dB)	Step Size (dB)	Model No	1 Pc. Price	See Web for Volume Pricing	ROW	
1 W	BNC Female	BNC Female	DC-750	Brass	DC-100: 1.1:1 100-300: 1.25:1 300-500: 1.25:1 500-750: 1.4:1	0-65	1.0	PE7008-1	\$903.91	See Web for Volume Pricing	41	
					1.4:1	0-82.5		PE70A1021	\$1,462.61			42
					DC-100: 1.1:1 100-300: 1.25:1 300-500: 1.25:1 500-750: 1.4:1	0-45.5	0.5	PE7008-2	\$949.00			
					1.4:1	0-82.5	0.5	PE7008-6	\$1,148.53			
						0-102	1.0	PE7008-5	\$1,246.50			

* Bi-Dir is Bi-Directional. If No then Attenuator is Directional. Maximum power applies to input connector only.

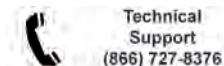

75 Ohm													
Max. Power (Watts)	Conn. Input	Conn. Output	Frequency Range (MHz)	Construction Material	VSWR Max. (MHz)	ATTN. Range (dB)	Step Size (dB)	Model No	1-4	5-9	10-24	25+	ROW
1 W	BNC Female	BNC Female	DC-500	Brass	DC-100: 1.1:1 100-300: 1.2:1 300-500: 1.3:1	0-45.5	0.5	PE7008-4	\$814.80	\$774.06	\$733.32	\$700.73	43
						0-65	1.0	PE7008-3	\$915.66	\$869.88	\$824.09	\$787.47	



Step Attenuators, Toggle													
75 Ohm													
Max. Power (Watts)	Conn. Input	Conn. Output	Frequency Range (MHz)	Construction Material	VSWR Max. (MHz)	ATTN. Range (dB)	Step Size (dB)	Model No	1-4	5-9	10-24	25+	ROW
1 W	BNC Female	BNC Female	DC-1,000	Aluminum	1.3:1	0-42		PE70A1001	\$718.15	\$682.24	\$646.34	\$617.61	44
	F Female	F Female	0.3-1,000		1.37:1	0-71		PE70A1008	\$783.99	\$744.79	\$705.59	\$674.23	45



Step Attenuators, Rotary													
50 Ohm													
Max. Power (Watts)	Conn. Input	Conn. Output	Frequency Range (MHz)	Construction Material	VSWR Max. (MHz)	ATTN. Range (dB)	Step Size (dB)	Model No	1 Pc. Price	See Web for Volume Pricing			ROW
1 W	BNC Female	BNC Female	DC-1,000	Aluminum	1.2:1	0-1	0.1	PE7034-1	\$616.01	See Web for Volume Pricing			46
					DC-1,000: 1.2:1	0-100	10.0	PE7034-2	\$732.04				
2 W	BNC Female	BNC Female	DC-2,000	Aluminum	DC-1,000: 1.2:1 1,000-2,200: 1.4:1	0-1	0.1	PE7034-6	\$644.02				
						0-10	1.0	PE70A1024	\$636.72				
						0-70	10.0	PE70A1022	\$666.95				
						0-10	1.0	PE70A1025	\$624.23				
						0-70	10.0	PE70A1023	\$644.81	50			



75 Ohm													
Max. Power (Watts)	Conn. Input	Conn. Output	Frequency Range (MHz)	Construction Material	VSWR Max. (MHz)	ATTN. Range (dB)	Step Size (dB)	Model No	1 Pc. Price	See Web for Volume Pricing			ROW
1 W	BNC Female	BNC Female	DC-500	Aluminum	DC-500: 1.3:1 500-1,000: 1.4:1	0-1	0.1	PE7035-1	\$486.95	See Web for Volume Pricing			51
						0-10	1.0	PE7035-2	\$424.59				
			DC-1,000			0-1	0.1	PE7035-5	\$962.47				



DC Bias Attenuators

50 Ohm



Max. Power (Watts)	Conn. Input	Conn. Output	Frequency Range (MHz)	Construction Material	VSWR Max.	Max. V (V)	Max. I (Amp)	ATTN. (dB)	Model No	1-9	10-24	25-49	50+	ROW
2 W	N Male	N Female	500-2,000	Passivated Stainless Steel	1.35:1	100	2	6	PE7062-6	\$173.90	\$165.21	\$156.51	\$149.55	52
								10	PE7062-10	\$168.22	\$159.81	\$151.40	\$144.67	
								20	PE7062-20	\$146.45	\$139.13	\$131.81	\$125.95	
	SMA Male	SMA Female						6	PE7061-6	\$142.50	\$135.38	\$128.25	\$122.55	53
								10	PE7061-10	\$142.50	\$135.38	\$128.25	\$122.55	
								20	PE7061-20	\$154.60	\$146.87	\$139.14	\$132.96	
	TNC Male	TNC Female						6	PE7063-6	\$156.51	\$148.68	\$140.86	\$134.60	54
								10	PE7063-10	\$180.59	\$171.56	\$162.53	\$155.31	
								20	PE7063-20	\$180.59	\$171.56	\$162.53	\$155.31	

75 Ohm



Max. Power (Watts)	Conn. Input	Conn. Output	Frequency Range (MHz)	Construction Material	VSWR Max.	Max. V (V)	Max. I (Amp)	ATTN. (dB)	Model No	1-9	10-24	25-49	50+	ROW
2 W	F Male	F Female	500-2,000	Brass	1.45:1	100	2	6	PE7064-6	\$182.97	\$173.82	\$164.67	\$157.35	55
								10	PE7064-10	\$182.97	\$173.82	\$164.67	\$157.35	
								20	PE7064-20	\$182.97	\$173.82	\$164.67	\$157.35	

Continuously Variable Attenuators

50 Ohm



Max. Power (Watts)	Conn. Input	Conn. Output	Frequency Range (MHz)	Construction Material	VSWR Max.	ATTN. (dB)	Model No	1	2-4	5-9	10+	ROW
5 W	SMA Female	SMA Female	DC-4,000		DC-1,000: 1.5:1 1,000-2,000: 1.6:1 2,000-3,000: 1.7:1 3,000-4,000: 1.8:1	5-95	PE7422	\$1,640.17	\$1,574.56	\$1,508.96	\$1,443.35	56

Waveguide Attenuators, See Page [340](#), [348](#)

ACTIVE ATTENUATORS

TTL, USB, CMOS and Relay



Type	Frequency Range (GHz)	Atten. Range (dB)	IL (dB)	Step Resolution (dB)	Switching Speed (µs)	Input/Output Connector	Model No	1 Pc. Price	See Web for Volume Pricing	ROW
CMOS	DC - 13	0 - 31.5	5	0.5	6,000,000	SMA Female	PE70A5003	\$4,585.27	See Web for Volume Pricing	57
Relay	DC - 1		1.5				1	PE70A8001		
	DC - 1	0 - 63	1.5	PE70A8000		\$902.70				
	DC - 1		2.2	F Female		PE70A8003	\$1,686.66			
	DC - 1	2.5	PE70A8004			\$2,008.12				
	DC - 1.5	0 - 127	3.2	PE70A8005		\$2,152.36				
DC - 2	0 - 63.75		0.25	SMA Female	PE70A8002	\$2,942.29	63			

TTL, USB, CMOS and Relay



Attenuators & Equalizers

Type	Frequency Range (GHz)	Atten. Range (dB)	IL (dB)	Step Resolution (dB)	Switching Speed (µs)	Input/Output Connector	Model No	1	2-4	5-9	10+	R O W
TTL	DC - 13	0 - 31.5	5.5	0.5	45	SMA Female	PE70A4000	\$4,935.25	\$4,737.84	\$4,540.43	\$4,343.02	64
	5 MHz - 2.15	0 - 63	5.25	1	5,000	F Female	PE70A5012	\$1,987.83	\$1,908.32	\$1,828.80	\$1,749.29	65
	30 MHz - 3	0 - 31.75	2.5	0.25	1,000	SMA Female	PE70A5004	\$1,560.02	\$1,497.62	\$1,435.22	\$1,372.82	66
	30 MHz - 3	0 - 63	4	1			PE70A5006	\$1,436.63	\$1,379.16	\$1,321.70	\$1,264.23	67
	30 MHz - 3	0 - 63.5	4	0.5			PE70A5005	\$1,496.97	\$1,437.09	\$1,377.21	\$1,317.33	68
	30 MHz - 3	0 - 95	6	1			PE70A5007	\$2,001.26	\$1,921.21	\$1,841.16	\$1,761.11	69
	30 MHz - 6	0 - 60	4	0.25	50,000	2.92mm Female	PE70A5000	\$6,002.99	\$5,762.87	\$5,522.75	\$5,282.63	70
	100 MHz - 18	0 - 30	5	1	PE70A5001		\$7,016.34	\$6,735.69	\$6,455.03	\$6,174.38	71	
	100 MHz - 40		8		PE70A5002		\$10,215.58	\$9,806.96	\$9,398.33	\$8,989.71	72	
	200 MHz - 6		5.5		PE70A5009		\$1,496.97	\$1,437.09	\$1,377.21	\$1,317.33	73	
Bench-Top TTL	200 MHz - 6	0 - 95	8		1	1,000	SMA Female	PE70A5013	\$9,325.93	\$8,952.89	\$8,579.86	\$8,206.82
	200 MHz - 6		8	PE70A5010			\$1,926.14	\$1,849.09	\$1,772.05	\$1,695.00	75	
TTL	450 MHz - 2.15	0 - 127	4.5	0.06	2,000	F Female	PE70A5011	\$2,011.27	\$1,930.82	\$1,850.37	\$1,769.92	76
	500 MHz - 18	0 - 60	4.5		1	SMA Female	PE70A6000	\$7,114.79	\$6,830.20	\$6,545.61	\$6,261.02	77
	700 MHz - 3	0 - 127	6			1	5,000	PE70A5008	\$1,923.31	\$1,846.38	\$1,769.45	\$1,692.51
	18 - 40	0 - 30	5		1	0.03	1	2.4mm Female	PE70A6001	\$7,023.63	\$6,742.68	\$6,461.74
100 MHz - 18	SMA Female			PE70A3900		\$4,169.44	\$4,002.66	\$3,835.88	\$3,669.11	80		
USB	100 MHz - 40	0 - 95	8.3	1	4,000	2.92mm Female	PE70A3901	\$5,669.20	\$5,442.43	\$5,215.66	\$4,988.90	81
	200 MHz - 6					SMA Female	PE70A3902	\$2,001.26	\$1,921.21	\$1,841.16	\$1,761.11	82

Variable Voltage Attenuators



Frequency Range (GHz)	Atten. Range (dB)	Insertion Loss (dB)	Switching Speed (µsec)	Input / Output Connectors	Model No	1	2-4	5-9	10+	R O W
DC - 20	0 - 30	3	50,000	SMA Female	PE70A1017	\$8,188.88	\$7,861.32	\$7,533.77	\$7,206.21	83
50 MHz - 2.2	0 - 20		10,000		PE70A1031	\$1,331.86	\$1,278.59	\$1,225.31	\$1,172.04	84
400 MHz - 6	0 - 40		3,000		PE70A1000	\$6,346.97	\$6,093.09	\$5,839.21	\$5,585.33	85
500 MHz - 18	0 - 60	4.5	500		PE70A2900	\$6,313.29	\$6,060.76	\$5,808.23	\$5,555.70	86
2 - 4		2			PE70A2000	\$5,329.04	\$5,115.88	\$4,902.72	\$4,689.56	87
4 - 8		2.5			PE70A2001	\$6,244.96	\$5,995.16	\$5,745.36	\$5,495.56	88
6 - 12		2.8			PE70A2002	\$6,172.69	\$5,925.78	\$5,678.87	\$5,431.97	89
8 - 18		3.7			PE70A2003	\$6,960.53	\$6,682.11	\$6,403.69	\$6,125.27	90

EQUALIZERS

Positive Slope



Frequency Range (GHz)	Typ. Equalizing Value (dB)	Typ. Small Signal IL (dB)	Typ Input-Output VSWR	Max. RF Input Power (dBm)	In-Out Connectors (Field Replaceable)	Model No	1-4	5-9	10-24	25+	R O W
0.5 MHz - 2	2	1.4	1.8:1	+30	SMA Female	PE70A9000	\$646.67	\$614.34	\$582.00	\$556.14	91
	4	1				PE70A9001	\$663.33	\$630.16	\$597.00	\$570.46	92
	6	1.8				PE70A9002	\$673.33	\$639.66	\$606.00	\$579.06	93
1 - 18	4	1				PE70A9003	\$106.67	\$101.34	\$96.00	\$91.74	94
	6	1				PE70A9004	\$1,153.33	\$1,095.66	\$1,038.00	\$991.86	95
	8	1.5				PE70A9005	\$1,153.33	\$1,095.66	\$1,038.00	\$991.86	96
2 - 6	2	1				PE70A9006	\$923.33	\$877.16	\$831.00	\$794.06	97
	4	1.5				PE70A9007	\$960.00	\$912.00	\$864.00	\$825.60	98
2 - 12		4				1.5	PE70A9008	\$923.33	\$877.16	\$831.00	\$794.06

* Bi-Dir is Bi-Directional. If No then Attenuator is Directional. Maximum power applies to input connector only.

See Our Website For Current Pricing & Real-Time Stock Availability!

Positive Slope

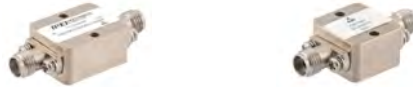

Frequency Range (GHz)	Typ. Equalizing Value (dB)	Typ. Small Signal IL (dB)	Typ Input-Output VSWR	Max. RF Input Power (dBm)	In-Out Connectors (Field Replaceable)	Model No	1-4	5-9	10-24	25+	ROW
2 - 12	8	2	1.8:1	+30	SMA Female	PE70A9009	\$1,000.00	\$950.00	\$900.00	\$860.00	1
6 - 18	2	2				PE70A9010	\$1,106.67	\$1,051.34	\$996.00	\$951.74	2
	4	2				PE70A9011	\$1,126.67	\$1,070.34	\$1,014.00	\$968.94	3
	6	2				PE70A9012	\$1,153.33	\$1,095.66	\$1,038.00	\$991.86	4
	8	2.5				PE70A9013	\$1,180.00	\$1,121.00	\$1,062.00	\$1,014.80	5
18 - 40	2	2	2:1	+30	2.92mm Female	PE70A9014	\$1,293.33	\$1,228.66	\$1,164.00	\$1,112.26	6
	4	2				PE70A9015	\$1,323.33	\$1,257.16	\$1,191.00	\$1,138.06	7
	6	2				PE70A9016	\$1,346.67	\$1,279.34	\$1,212.00	\$1,158.14	8
26.5 - 40	4	3			PE70A9017	\$1,293.33	\$1,228.66	\$1,164.00	\$1,112.26	9	
	5	2.5			PE70A9018	\$1,313.33	\$1,247.66	\$1,182.00	\$1,129.46	10	

BALUNS



Frequency Range (MHz)	Balanced Impedance (Ω)	Unbalanced Impedance (Ω)	Package	Model No	1-9	10-24	25-49	50+	ROW
20 - 520	25	50	Surface Mount	PE2BL1001	\$241.21	\$229.15	\$217.09	\$207.44	11
20 - 1,000				PE2BL1002	\$233.40	\$221.73	\$210.06	\$200.72	12
80 - 1,000				PE2BL1003	\$213.94	\$203.24	\$192.55	\$183.99	13
100 - 520				PE2BL1004	\$233.40	\$221.73	\$210.06	\$200.72	14
225 - 2,000				PE2BL1000	\$227.09	\$215.74	\$204.38	\$195.30	15
500 - 2,000				PE2BL1005	\$218.57	\$207.64	\$196.71	\$187.97	16
800 - 2,500				PE2BL1006	\$269.86	\$256.37	\$242.87	\$232.08	17

BIAS TEES AND DC BLOCKS

Bias Tees



Impedance	Frequency Range (MHz.)	Max. V (V)	Max. I (mA)	Connector	Bias Connector	Model No	1 Pc. Price	See Web for Volume Pricing	ROW
50 Ohm	0.03 - 70,000	25	250	1.85mm	SMA	PE1619	\$2,908.98	See Web for Volume Pricing	18
	0.03 - 85,000			PE1620	\$3,128.83	19			
	0.05 - 50,000	2.4mm	SMA	PE1610	\$1,883.87	20			
	0.1 - 12,400	SMA	Solder Pin	PE1606A	\$571.23	21			
	0.1 - 18,000			PE1BT1002	\$702.94	22			
	0.1 - 26,500	24	750	3.5mm	Solder Pin	PE1608	\$1,193.37		23
	10 - 2,500	100	2500	SMA	Solder Pin	PE1611	\$349.79		24
	10 - 4,000					PE1613	\$469.79		25
	10 - 6,000	100	2500	N	Solder Pin	PE1612	\$315.31		26
						PE1614	\$432.24		27
						PE1615	\$343.74		28
	100 - 6,000	100	7000	SMA	Solder Pin	PE1616	\$412.05		29
						PE1616	\$412.05		29
	10 - 40,000			2.92mm	Pin	PE1621	\$1,190.68		30
	100 - 6,000	50	500	SMA	Solder Pin	PE1604	\$327.47		31
	100	7000	PE1617			\$693.82	32		
	250 - 2,500	100	7000	N	Solder Pin	PE1618	\$778.47		33
	400 - 10,000	50	200	SMA	Solder Pin	PE1605	\$509.26		34
	500 - 10,000				Pin	PE1BT1000	\$882.93		35
	500 - 40,000			2.92mm	Pin	PE1622	\$1,407.21		36
SMA					PE1BT1001	Call	37		
1,000 - 5,000	50	1000	SMA	Solder Pin	PE1603	\$326.30	38		

DC Blocks



Bias Tees & DC Blocks

See Our Website For Current Pricing & Real-Time Stock Availability!

Impedance	Connector	Frequency Range (MHz.)	Type	Max. V (V)	Model No	1 Pc. Price	See Web for Volume Pricing			ROW
50 Ohm	1.85mm	10 - 65,000	Inner		PE8258	\$689.00	See Web for Volume Pricing			39
			Inner		PE8237	\$1,504.86				40
	2.4mm	100 - 50,000	Inner/Outer		PE8239	\$1,799.00				41
			Outer	75	PE8238	\$1,599.00				42
			Inner		PE8222	\$302.25				43
	2.92mm	10 - 26,500	Inner/Outer		PE8224	\$469.14				44
			Outer	200	PE8223	\$358.25				45
			Inner		PE8225	\$739.83				46
		10 - 40,000	Inner/Outer		PE8227	\$1,235.03				47
			Outer	200	PE8226	\$1,508.91				48
			Inner		PE8216	\$195.18				49
	BNC	10 - 4,000	Inner/Outer		PE8218	\$315.78				50
			Outer		PE8217	\$270.66				51
			Inner		PE8213	\$149.11				52
	N		Inner		PE8251	\$199.24				53
			Inner/Outer		PE8215	\$269.07				54
			Outer		PE8214	\$241.94				55
			Inner		PE8210	\$113.55				56
	SMA	10 - 18,000	Inner		PE8250	\$149.08				57
			Inner/Outer		PE8212	\$232.12				58
			Outer		PE8211	\$212.29				59
	TNC		Inner		PE8219	\$234.44				60
			Inner	950	PE8252	\$301.85				61
			Inner/Outer		PE8221	\$395.72				62
75 Ohm	BNC	100 - 4,000	Outer		PE8231	\$308.67	64			
			Inner/Outer		PE8233	\$374.91	65			
			Outer	200	PE8232	\$185.63	66			
	F	10 - 2,000	Inner		PE8240	\$128.41	67			
			Inner/Outer		PE8242	\$252.98	68			
			Outer		PE8241	\$198.36	69			
	N	100 - 4,000	Inner	200	PE8234	\$264.48	70			
			Inner/Outer		PE8236	\$259.45	71			

The Cable Creator™

Configure and Customize Your
Cable Assemblies Online



Over 250,000 Custom Cable Configurations Available to Ship Same Day!



- Choose from over 2,030 RF coax connectors
- 123 coaxial cable types, including Twinax
- Choose your desired length (metric or standard)
- Includes high-reliability and low PIM assembly types
- ISO 9001:2015 certified production facility
- Optional Customizations:
 - Lead-free solder
 - Heat shrink
 - Labeling
 - Test plots
 - Clocking of right angle connectors

Our Latest Cable Assembly Additions

Available in Standard and Custom Lengths! In-Stock and Shipped Same Day



High-Reliability Cable Assemblies

- MIL-DTL-17 and Temperature Conditioned, Low Loss Options
- Maximum Frequency Levels as High as 18 GHz
- J-STD Soldering Processes
- IPC/WHMA-A-620 Workmanship
- Lot Traceability for Cables, Connectors, Heat Shrink and Solder
- Detailed Test Reports and Plots

Low PIM Cable Assemblies

- Maximum PIM Levels as Low as -160dBc
- 100% PIM Tested with Results Marked on the Cable
- Low Loss, Excellent VSWR
- Lightweight, Extremely Flexible
- UL-Rated, Fire-Rated, Outdoor-Rated Cable Types
- Available with 4.3-10, 7/16 DIN, 4.1/9.5 Mini-DIN, Type-N, NEX10, SMA, and QMA Connector Series



40 GHz and 67 GHz Skew Matched Cable Pairs

- 1 ps Delay Match
- Excellent VSWR of 1.4:1
- 100% Tested Up to 40 or 67 GHz
- Extremely Flexible
- Polarity Indicators on Cable Ends

Handheld RF Analyzer Rugged Phase Stable Cable Assemblies

- VSWR as Low as 1.2:1
- Phase Stability with Flexure as Low as ± 1.5 Degrees
- Amplitude Stability with Flexure as Low as ± 0.1 dB
- Rugged Armor with 1200 PSI Crush Resistance, Protects Cable During Field Measurements
- UV Resistant Jacket
- Test Data Included with Each Serialized Cable



PE-P160LL Low Loss Cable Assemblies

- Triple-Shielded Low Loss Cable
- Maximum Frequency Levels as High as 18 GHz
- Shielding Effectivity >90 dB
- FEP Jacket
- 83% Phase Velocity
- Available with Type-N, SMA, and TNC Connector Series with Bulkhead and Right Angle Options

Coaxial Cable Assemblies Selection Guide

Do you need a cable assembly that isn't in our RF Product Guide?
 Visit our website to view our entire selection of available assemblies or
 to build your own custom length cable assembly!

3 Easy Ways to Find your Product.....

1. Search by PE Part Number

If you know the PE part number you are searching for, please reference our Part Number Index on Page [355](#)

2. Quick Reference Guide

(Page number refers to first appearance of product in the Cable Assemblies Section)

Cable Connector	Page	Cable Connector	Page	Cable Connector	Page	Cable Connector	Page	Cable Connector	Page
1.0/2.3	94	75 Ohm 1.6/5.6	186	C	112	MMCX	118	SMC	173
1.0mm	94	75 Ohm BNC	186	FAKRA	113	N	90	SMP	174
1.85mm	94	75 Ohm F	187	FME	114	NMO Mount	137	SSMA	175
10-32	101	75 Ohm Mini SMB	187	GR874	115	QMA	93	SSMB	176
2.4mm	94	75 Ohm N	188	HMCX32 1.2	184	QN	138	SSMC	176
2.92mm	95	75 Ohm SMB	189	HN	115	Reverse Polarity SMA	156	TNC	91
2.92mm NMD	185	75 Ohm SMC	189	LC	115	Reverse Polarity TNC	180	UHF	183
3.5mm	96	75 Ohm TNC	189	MC-Card	116	Reverse Thread SMA	157	UMCX	184
3.5mm NMD	97	78 Ohm BNC Twinax	189	MCX	116	SC	138	UMCX 2.1	184
4.1/9.5 Mini DIN	93	95 Ohm 3/4"-20 Twinax	189	MHV	117	SHV	139	UMCX 2.5	184
4.3-10	93	BMA	102	Mini UHF	118	SMA	91	WMCX 1.6	184
7/16 DIN	93	BNC	90	MMBX	119	SMB	171		

Cable Assemblies

3. Cable Assembly Locator

(Cable Assembly Locator on Page [86-89](#) to locate the Cable Assembly you need by either connector end.)



SMA Female Bulkhead to MCX Plug Right Angle
PE39421-12

SMA FEMALE BULKHEAD TO:	EXAMPLE	MCX PLUG RIGHT ANGLE TO:	EXAMPLE
MCX PLUG RIGHT ANGLE.....	23	MCX PLUG.....	78
MMCX PLUG RIGHT ANGLE.....	23	MCX PLUG RIGHT ANGLE.....	79
SMA FEMALE BULKHEAD.....	43	N FEMALE BULKHEAD.....	25
SMA MALE.....	17,23,31,32	SMA FEMALE BULKHEAD.....	23
SMA MALE RIGHT ANGLE.....	17,23,40,41	TNC FEMALE BULKHEAD.....	27
UMCX PLUG.....	76	UMCX PLUG.....	76

The Cable Assembly Locator example above includes Between-Series Cable Assembly part numbers in two configurations:
Connector 1 to Connector 2 as well as Connector 2 to Connector 1 will be found in the same location.

Products can only be found under the first instance of the series combination. As an example, PE39421-12 above will be found in only one location in the Cable Assembly Section.

All Pasternack coaxial cable assembly part number indicate the length of the assembly (in inches) following the hyphen.
 Example: PE300-24 and PE300-26.5 are 24 inches and 26.5 inches in length respectively

NOTE: All cable assemblies have a length tolerance of 1.5% or $\pm 3/8"$, whichever is greater.

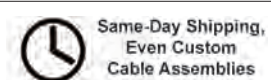

Cable Assembly Locator

Cable Assemblies

Connector Type	Page
1.0/2.3 Jack Bulkhead To:	
1.0/2.3 JACK BULKHEAD	94
1.0/2.3 Plug To:	
BNC FEMALE BULKHEAD	94
1.0/2.3 Plug Right Angle To:	
BNC MALE	94
1.0mm Male To:	
1.0mm MALE	94
1.85mm Male To:	
1.85mm FEMALE	94
1.85mm MALE	94
1.85mm MALE RIGHT ANGLE	94
2.4mm Female To:	
2.4mm FEMALE	95
2.4mm Female Bulkhead To:	
SMA MALE	95
2.4mm Male To:	
1.85mm MALE	94
2.4mm FEMALE	95
2.4mm MALE	94
2.4mm MALE RIGHT ANGLE	95
2.92mm MALE	95
SMA MALE	95
SMA MALE RIGHT ANGLE	95
2.92mm Male To:	
2.4mm MALE	95
2.92mm FEMALE	96
2.92mm FEMALE BULKHEAD	96
2.92mm MALE	95
2.92mm MALE	96
2.92mm NMD Female To:	
2.92mm FEMALE	185
2.92mm MALE	185
3.5mm Female To:	
3.5mm FEMALE	96
3.5mm NMD FEMALE	97
3.5mm Male To:	
3.5mm FEMALE	96
3.5mm FEMALE BULKHEAD	96
3.5mm MALE	96
3.5mm NMD Female To:	
3.5mm MALE	97
4.1/9.5 Mini DIN Female To:	
4.3-10 MALE	93
7/16 DIN MALE	93
N MALE	93
OMA MALE	93
SMA MALE	93
4.3-10 MALE	93
7/16 DIN MALE	98
N MALE	98
OMA MALE	98
SMA MALE	98
4.1/9.5 Mini DIN Male To:	
4.1/9.5 MINI DIN FEMALE	93
4.1/9.5 MINI DIN MALE	93
4.1/9.5 MINI DIN MALE RIGHT ANGLE	93
4.3-10 FEMALE	93
7/16 DIN FEMALE	93
7/16 DIN MALE	93
N FEMALE	93
OMA FEMALE	93
OMA MALE	93
OMA MALE RIGHT ANGLE	93
SMA FEMALE	93
SMA MALE	93
SMA MALE RIGHT ANGLE	93
4.1/9.5 MINI DIN FEMALE	97
4.1/9.5 MINI DIN MALE	97
4.1/9.5 MINI DIN MALE RIGHT ANGLE	97
4.3-10 FEMALE	97
7/16 DIN FEMALE	97
7/16 DIN MALE	97
OMA FEMALE	97
OMA MALE	97
OMA MALE RIGHT ANGLE	97
SMA FEMALE	97
SMA MALE	97

Connector Type	Page
SMA MALE	97
SMA MALE RIGHT ANGLE	97
4.1/9.5 Mini DIN Male Right Angle To:	
4.1/9.5 MINI DIN MALE RIGHT ANGLE	93
4.3-10 FEMALE	93
4.3-10 MALE	93
7/16 DIN MALE	93
N MALE	93
OMA MALE	93
SMA MALE	93
4.1/9.5 MINI DIN MALE RIGHT ANGLE	98
4.3-10 FEMALE	98
4.3-10 MALE	98
7/16 DIN MALE	98
N MALE	98
OMA MALE	98
SMA MALE	98
4.3-10 Female To:	
7/16 DIN MALE	93
N MALE	93
OMA MALE	93
SMA MALE	93
N MALE	99
OMA MALE	99
SMA MALE	99
4.3-10 Male To:	
4.3-10 FEMALE	93
4.3-10 MALE	93
7/16 DIN FEMALE	93
7/16 DIN MALE	93
OMA FEMALE	93
OMA MALE	93
OMA MALE RIGHT ANGLE	93
SMA FEMALE	93
SMA MALE	93
SMA MALE RIGHT ANGLE	93
4.3-10 FEMALE	98
4.3-10 MALE	98
7/16 DIN FEMALE	98
7/16 DIN MALE	98
N MALE	99
OMA FEMALE	99
OMA MALE	99
OMA MALE RIGHT ANGLE	99
SMA FEMALE	99
SMA MALE	99
SMA MALE RIGHT ANGLE	99
4.3-10 Male Right Angle To:	
4.3-10 MALE	93
4.3-10 MALE RIGHT ANGLE	93
4.3-10 MALE	99
4.3-10 MALE RIGHT ANGLE	99
7/16 DIN Female To:	
N MALE	93
OMA MALE	93
SMA MALE	93
N MALE	101
OMA MALE	101
SMA MALE	101
7/16 DIN Male To:	
7/16 DIN FEMALE	93
7/16 DIN MALE	93
OMA FEMALE	93
OMA MALE	93
OMA MALE RIGHT ANGLE	93
SMA FEMALE	93
SMA MALE	93
SMA MALE RIGHT ANGLE	93
4.3-10 FEMALE	99
7/16 DIN FEMALE	100
7/16 DIN MALE	99
7/16 DIN MALE RIGHT ANGLE	100
N MALE	100
OMA FEMALE	100
OMA MALE	100
OMA MALE RIGHT ANGLE	100
SC MALE	101
SMA FEMALE	101
SMA MALE	101
SMA MALE RIGHT ANGLE	101

Connector Type	Page
7/16 DIN Male Right Angle To:	
7/16 DIN MALE	93
7/16 DIN MALE RIGHT ANGLE	93
7/16 DIN MALE	101
7/16 DIN MALE RIGHT ANGLE	101
10-32 Female To:	
BNC MALE	102
10-32 Male To:	
10-32 MALE	101
10-32 MALE RIGHT ANGLE	101
BNC MALE	101
10-32 Male Right Angle To:	
10-32 MALE RIGHT ANGLE	101
10-32 MALE RIGHT ANGLE	102
75 Ohm 1.6/5.6 Plug To:	
75 Ohm 1.6/5.6 PLUG	186
75 Ohm BNC MALE	186
75 Ohm BNC Female To:	
75 Ohm BNC FEMALE	187
75 Ohm BNC Female Bulkhead To:	
75 Ohm BNC FEMALE BULKHEAD	187
75 Ohm BNC Male To:	
75 Ohm BNC FEMALE	186
75 Ohm BNC FEMALE BULKHEAD	186
75 Ohm BNC MALE	186
75 Ohm BNC MALE RIGHT ANGLE	186
75 Ohm BNC Male Right Angle To:	
75 Ohm BNC MALE RIGHT ANGLE	186
75 Ohm F Male To:	
75 Ohm BNC MALE	187
75 Ohm F FEMALE	187
75 Ohm F FEMALE BULKHEAD	187
75 Ohm F MALE	187
75 Ohm F MALE RIGHT ANGLE	187
75 Ohm Mini SMB Plug To:	
75 Ohm BNC MALE	187
75 Ohm MINI SMB PLUG	188
75 Ohm MINI SMB PLUG RIGHT ANGLE	188
75 Ohm Mini SMB Plug Right Angle To:	
75 Ohm F FEMALE BULKHEAD	188
75 Ohm MINI SMB PLUG RIGHT ANGLE	188
75 Ohm N Female To:	
75 Ohm N FEMALE	189
75 Ohm N Male To:	
75 Ohm BNC MALE	188
75 Ohm F FEMALE	188
75 Ohm F MALE	188
75 Ohm N FEMALE	188
75 Ohm N MALE	188
75 Ohm SMB Plug To:	
75 Ohm BNC MALE	189
75 Ohm SMB PLUG	189
75 Ohm SMC Plug To:	
75 Ohm BNC MALE	189
75 Ohm SMC PLUG	189
75 Ohm TNC Male To:	
75 Ohm BNC MALE	189
75 Ohm TNC MALE	189
78 Ohm BNC Twinax Plug To:	
78 Ohm BNC TWINAX PLUG	189
95 Ohm 3/4"-20 Twinax Male To:	
95 Ohm 3/4"-20 TWINAX MALE	189
BMA Jack To:	
BMA JACK	104
BNC MALE	104
N MALE	104
SMA MALE	105
SMA MALE RIGHT ANGLE	105
SMP FEMALE	105
SMP FEMALE RIGHT ANGLE	105
TNC MALE	105
BMA Jack 2 Hole Flange To:	
BMA JACK 2 HOLE FLANGE	106
BNC MALE	106

Cable Assembly Locator

Connector Type	Page
BMA Jack 2 Hole Flange To:	
N MALE.....	106
SMA MALE.....	106
SMA MALE RIGHT ANGLE.....	106
SMP FEMALE.....	106
SMP FEMALE RIGHT ANGLE.....	106
TNC MALE.....	106
BMA Jack Bulkhead To:	
BMA JACK BULKHEAD.....	105
BMA Jack Right Angle 2 Hole Flange To:	
BMA JACK RIGHT ANGLE 2 HOLE FLANGE.....	107
BMA Plug Bulkhead To:	
BMA JACK.....	102
BMA JACK 2 HOLE FLANGE.....	102
BMA JACK BULKHEAD.....	102
BMA JACK RIGHT ANGLE 2 HOLE FLANGE.....	102
BMA PLUG BULKHEAD.....	102
BNC MALE.....	103
N MALE.....	103
SMA MALE.....	103
SMA MALE RIGHT ANGLE.....	103
SMP FEMALE.....	103
SMP FEMALE RIGHT ANGLE.....	104
TNC MALE.....	104
BNC Female To:	
BNC FEMALE.....	112
BNC MALE RIGHT ANGLE.....	112
NMO Mount Sexless.....	185
SMA MALE.....	112
BNC Female Bulkhead To:	
SMA MALE.....	112
BNC Male To:	
BNC MALE.....	90
N FEMALE.....	90
N MALE.....	90
SMA FEMALE.....	90
SMA MALE.....	90
SMA MALE RIGHT ANGLE.....	90
TNC MALE.....	90
BNC FEMALE.....	110
BNC FEMALE BULKHEAD.....	110
BNC MALE.....	107
BNC MALE.....	108
BNC MALE.....	109
BNC MALE RIGHT ANGLE.....	109
BNC MALE RIGHT ANGLE.....	110
Cut Lead Sexless.....	185
MHV MALE.....	111
N FEMALE.....	107
N FEMALE BULKHEAD.....	107
N MALE.....	107
N MALE.....	111
NMO Mount Sexless.....	185
SHV PLUG.....	111
SMA FEMALE BULKHEAD.....	108
SMA MALE.....	107
SMA MALE.....	111
SMA MALE RIGHT ANGLE.....	108
SSMC PLUG.....	111
SSMC PLUG RIGHT ANGLE.....	111
TNC MALE.....	108
BNC Male Right Angle To:	
BNC FEMALE BULKHEAD.....	112
BNC MALE RIGHT ANGLE.....	111
BNC MALE RIGHT ANGLE.....	112
SMA FEMALE.....	112
TNC MALE RIGHT ANGLE.....	112
C Male To:	
C MALE.....	112
C MALE.....	113
C Male Right Angle To:	
C MALE.....	113
FAKRA Jack To:	
FAKRA JACK.....	114
FAKRA JACK RIGHT ANGLE.....	114
REVERSE POLARITY TNC MALE.....	114
SMA FEMALE.....	114
FAKRA Jack Right Angle To:	
FAKRA PLUG.....	114

Connector Type	Page
FAKRA Plug To:	
FAKRA JACK.....	113
FAKRA JACK RIGHT ANGLE.....	113
FAKRA JACK RIGHT ANGLE.....	114
FAKRA PLUG.....	113
FME Jack To:	
BNC MALE.....	115
FME JACK.....	115
FME Plug To:	
BNC MALE.....	114
FME Plug Bulkhead To:	
UMCX PLUG RIGHT ANGLE.....	115
GR874 Sexless To:	
BNC MALE.....	115
GR874 Sexless.....	115
HMCX32 1.2 Plug To:	
HMCX32 1.2 PLUG.....	184
HN Male To:	
7/16 DIN MALE RIGHT ANGLE.....	115
HN MALE.....	115
HN Male Right Angle To:	
HN FEMALE.....	115
LC Male To:	
LC MALE.....	115
LC MALE.....	116
LC Male Right Angle To:	
HN MALE.....	116
MC-Card Plug To:	
MC-Card PLUG.....	116
MCX Jack To:	
MCX JACK.....	117
MCX Plug To:	
75 Ohm BNC MALE.....	185
BNC MALE.....	116
MCX PLUG.....	116
MCX PLUG RIGHT ANGLE.....	116
SMA MALE.....	116
TNC FEMALE BULKHEAD.....	116
MCX Plug Right Angle To:	
BNC FEMALE 4 HOLE FLANGE.....	116
MCX JACK BULKHEAD.....	117
MCX PLUG RIGHT ANGLE.....	116
SMA MALE.....	117
MHV Male To:	
MHV MALE.....	117
MHV MALE RIGHT ANGLE.....	117
SHV PLUG.....	117
SHV PLUG.....	118
Mini UHF Male To:	
MINI UHF MALE.....	118
NMO Mount Sexless.....	185
MMBX Plug To:	
MMBX PLUG.....	119
MMBX PLUG RIGHT ANGLE.....	119
SMA FEMALE.....	119
SMA FEMALE BULKHEAD.....	119
SMA MALE.....	119
SMA MALE RIGHT ANGLE.....	119
SSMB JACK BULKHEAD.....	119
TNC FEMALE BULKHEAD.....	119
MMBX Plug Right Angle To:	
MMBX PLUG RIGHT ANGLE.....	119
REVERSE POLARITY SMA FEMALE BULKHEAD.....	120
SMA FEMALE.....	120
SMA FEMALE BULKHEAD.....	120
SMA MALE.....	120
SMA MALE RIGHT ANGLE.....	120
TNC FEMALE BULKHEAD.....	120
MMCX Plug To:	
MMCX PLUG.....	118
MMCX PLUG RIGHT ANGLE.....	118
N FEMALE BULKHEAD.....	118
SMC PLUG.....	118
MMCX Plug Right Angle To:	
BNC FEMALE BULKHEAD.....	118

Connector Type	Page
MMCX PLUG.....	118
SMA FEMALE.....	119
SMA MALE RIGHT ANGLE.....	118
N Female To:	
7/16 DIN MALE.....	93
N FEMALE.....	90
N FEMALE.....	91
N FEMALE.....	93
N MALE.....	93
N MALE RIGHT ANGLE.....	91
SMA MALE.....	90
SMA MALE.....	91
SMA MALE RIGHT ANGLE.....	90
SMA MALE RIGHT ANGLE.....	91
TNC MALE.....	90
TNC MALE.....	91
7/16 DIN MALE.....	135
N FEMALE.....	134
N FEMALE.....	135
N FEMALE BULKHEAD.....	134
N FEMALE BULKHEAD.....	135
NMO Mount Sexless.....	185
ON MALE RIGHT ANGLE.....	135
SMA MALE.....	134
SMA MALE RIGHT ANGLE.....	134
SMA MALE RIGHT ANGLE.....	135
TNC MALE.....	135
N Female 4 Hole Flange To:	
MMCX PLUG RIGHT ANGLE.....	137
N Female Bulkhead To:	
BNC MALE.....	136
HMCX32 1.2 PLUG.....	137
MCX PLUG RIGHT ANGLE.....	136
MMCX PLUG RIGHT ANGLE.....	136
N FEMALE BULKHEAD.....	135
N FEMALE BULKHEAD.....	136
N MALE.....	136
N MALE RIGHT ANGLE.....	136
OMA MALE RIGHT ANGLE.....	136
REVERSE POLARITY SMA MALE RIGHT ANGLE.....	137
SMA FEMALE.....	136
SMA FEMALE BULKHEAD.....	137
SMA MALE.....	135
SMA MALE.....	136
SMA MALE RIGHT ANGLE.....	135
SMA MALE RIGHT ANGLE.....	136
SMP FEMALE RIGHT ANGLE.....	137
TNC FEMALE BULKHEAD.....	137
TNC MALE.....	136
TNC MALE.....	137
TNC MALE RIGHT ANGLE.....	137
UMCX 2.5 PLUG.....	137
UMCX 2.5 PLUG.....	137
N Male To:	
4.1/9.5 MINI DIN MALE.....	93
4.3-10 MALE.....	93
7/16 DIN FEMALE.....	93
7/16 DIN MALE.....	93
7/16 DIN MALE RIGHT ANGLE.....	93
N FEMALE.....	90
N FEMALE.....	91
N FEMALE.....	93
N MALE.....	90
N MALE.....	91
N MALE.....	93
N MALE RIGHT ANGLE.....	91
OMA FEMALE.....	93
OMA MALE.....	93
OMA MALE RIGHT ANGLE.....	93
SMA FEMALE.....	93
SMA MALE.....	90
SMA MALE.....	93
SMA MALE RIGHT ANGLE.....	90
SMA MALE RIGHT ANGLE.....	93
TNC MALE.....	90
4.1/9.5 MINI DIN MALE.....	121
7/16 DIN FEMALE.....	122
7/16 DIN MALE.....	121
7/16 DIN MALE.....	122
7/16 DIN MALE RIGHT ANGLE.....	122
BNC FEMALE BULKHEAD.....	123
BNC MALE.....	122
C FEMALE.....	123

Cable Assemblies

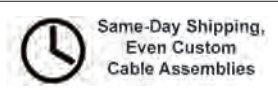
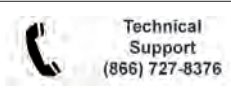

Cable Assembly Locator

Connector Type	Page
N Male To:	
MINI UHF MALE	123
N FEMALE	121
N FEMALE	126
N FEMALE	127
N FEMALE 4 HOLE FLANGE	128
N FEMALE BULKHEAD	121
N FEMALE BULKHEAD	127
N FEMALE BULKHEAD	128
N MALE	120
N MALE	123
N MALE	124
N MALE	125
N MALE RIGHT ANGLE	125
N MALE RIGHT ANGLE	126
NMO Mount Sexless	185
OMA FEMALE	129
OMA MALE	128
OMA MALE RIGHT ANGLE	128
OMA MALE RIGHT ANGLE	129
ON MALE	129
ON MALE RIGHT ANGLE	129
REVERSE POLARITY TNC MALE	131
REVERSE POLARITY TNC MALE	132
REVERSE POLARITY TNC MALE RIGHT ANGLE	132
SHV PLUG	129
SMA FEMALE	130
SMA FEMALE BULKHEAD	130
SMA MALE	121
SMA MALE	129
SMA MALE RIGHT ANGLE	121
SMA MALE RIGHT ANGLE	129
SMA MALE RIGHT ANGLE	130
SSMC JACK BULKHEAD	130
SSMC PLUG	130
SSMC PLUG RIGHT ANGLE	130
TNC FEMALE	131
TNC FEMALE BULKHEAD	131
TNC MALE	121
TNC MALE	130
TNC MALE	131
TNC MALE RIGHT ANGLE	131
UMCX PLUG RIGHT ANGLE	132
N Male Right Angle To:	
N MALE	93
N MALE RIGHT ANGLE	91
N MALE RIGHT ANGLE	93
BNC MALE	132
N FEMALE	133
N FEMALE BULKHEAD	133
N MALE	132
N MALE RIGHT ANGLE	132
N MALE RIGHT ANGLE	133
SMA FEMALE BULKHEAD	134
SMA MALE	133
SMA MALE RIGHT ANGLE	133
TNC FEMALE BULKHEAD	134
TNC MALE	134
TNC MALE RIGHT ANGLE	134
UHF MALE	134
NMO Mount Sexless To:	
TNC MALE	137
OMA Female To:	
SMA MALE	93
SMA MALE	138
OMA Male To:	
OMA FEMALE	93
OMA MALE	93
OMA MALE RIGHT ANGLE	93
SMA FEMALE	93
SMA MALE	93
SMA MALE RIGHT ANGLE	93
OMA FEMALE	138
OMA MALE	137
OMA MALE	138
OMA MALE RIGHT ANGLE	138
SMA FEMALE	138
SMA MALE	138
SMA MALE RIGHT ANGLE	138
OMA Male Right Angle To:	
OMA MALE RIGHT ANGLE	93
SMA MALE	93

Connector Type	Page
OMA MALE RIGHT ANGLE	138
SMA MALE	138
QN Male To:	
QN MALE	138
QN MALE RIGHT ANGLE	138
QN Male Right Angle To:	
N FEMALE	138
Reverse Polarity SMA Female Bulkhead To:	
HMCX32 1.2 PLUG	170
SMA MALE	169
SMA MALE RIGHT ANGLE	169
UMCX 2.1 PLUG	170
UMCX 2.5 PLUG	170
UMCX PLUG RIGHT ANGLE	170
WMCX 1.6 PLUG	170
Reverse Polarity SMA Male To:	
BNC MALE	156
MCX PLUG RIGHT ANGLE	156
N FEMALE BULKHEAD	157
N MALE	156
N MALE	157
REVERSE POLARITY SMA MALE	157
TNC MALE	157
Reverse Polarity SMA Male Right Angle To:	
N MALE	163
N MALE RIGHT ANGLE	163
SMA MALE	163
Reverse Polarity TNC Female To:	
REVERSE POLARITY SMA MALE	182
Reverse Polarity TNC Female Bulkhead To:	
MMCX PLUG	183
REVERSE POLARITY TNC MALE	183
SSMC PLUG RIGHT ANGLE	183
UMCX PLUG	183
Reverse Polarity TNC Male To:	
BNC MALE	180
Reverse Thread SMA Male To:	
Reverse Thread SMA MALE	157
SC Male To:	
SC MALE	138
SC MALE	139
SHV Jack Bulkhead To:	
SHV PLUG	139
SHV Plug To:	
SHV JACK BULKHEAD	139
SHV PLUG	139
SMA Female To:	
N FEMALE	91
N FEMALE	92
N MALE	91
N MALE	92
N MALE RIGHT ANGLE	91
N MALE RIGHT ANGLE	92
SMA FEMALE	91
SMA FEMALE	92
SMA FEMALE	93
SMA MALE	91
SMA MALE	92
SMA MALE	93
SMA MALE RIGHT ANGLE	91
SMA MALE RIGHT ANGLE	92
SMA MALE RIGHT ANGLE	93
TNC FEMALE	91
TNC FEMALE	92
TNC FEMALE	91
TNC FEMALE	92
TNC MALE	91
TNC MALE	92
TNC MALE	91
TNC MALE RIGHT ANGLE	91
TNC MALE RIGHT ANGLE	92
1.85mm MALE	140
7/16 DIN MALE	140
BNC MALE	140
BNC MALE	141
BNC MALE RIGHT ANGLE	141
FAKRA JACK	141
FAKRA JACK	142
FAKRA JACK	141
FAKRA PLUG	141
HMCX32 1.2 PLUG	156
MC-Card PLUG	142
MINI UHF MALE	142
MMCX PLUG	142
MMCX PLUG RIGHT ANGLE	142
N FEMALE	144
N FEMALE BULKHEAD	144
N FEMALE BULKHEAD	145

Connector Type	Page
SSMC PLUG	166
SSMC PLUG RIGHT ANGLE	166
TNC FEMALE BULKHEAD	166
TNC MALE	166
TNC MALE RIGHT ANGLE	166
Trimmed Lead Sexless	185
SMA Female 2 Hole Flange To:	
SMA FEMALE 2 HOLE FLANGE	170
SMP FEMALE	170
SMP FEMALE RIGHT ANGLE	170
SMA Female 4 Hole Flange To:	
MMCX PLUG RIGHT ANGLE	170
SMA FEMALE 4 HOLE FLANGE	170
SMA FEMALE 4 HOLE FLANGE	171
SMA Female Bulkhead To:	
HMCX32 1.2 PLUG	169
MCX PLUG RIGHT ANGLE	166
MMCX PLUG	166
MMCX PLUG RIGHT ANGLE	167
N FEMALE BULKHEAD	167
N MALE	167
N MALE RIGHT ANGLE	167
REVERSE POLARITY SMA MALE	168
SMA FEMALE	167
SMA FEMALE BULKHEAD	166
SMA FEMALE BULKHEAD	167
SMA FEMALE BULKHEAD	168
SMA MALE	167
SMA MALE RIGHT ANGLE	167
SMB PLUG RIGHT ANGLE	168
SMP FEMALE	168
SMP FEMALE RIGHT ANGLE	168
SSMC PLUG	168
SSMC PLUG RIGHT ANGLE	168
SSMC PLUG RIGHT ANGLE	169
TNC FEMALE BULKHEAD	169
TNC MALE	166
TNC MALE	169
TNC MALE RIGHT ANGLE	169
UMCX 2.1 PLUG	169
UMCX 2.5 PLUG	169
UMCX PLUG RIGHT ANGLE	169
WMCX 1.6 PLUG	169
SMA Male To:	
7/16 DIN MALE	93
N FEMALE	91
N FEMALE	92
N MALE	91
N MALE	92
N MALE RIGHT ANGLE	91
N MALE RIGHT ANGLE	92
SMA FEMALE	91
SMA FEMALE	92
SMA FEMALE	93
SMA MALE	91
SMA MALE	92
SMA MALE	93
SMA MALE RIGHT ANGLE	91
SMA MALE RIGHT ANGLE	92
SMA MALE RIGHT ANGLE	93
TNC FEMALE	91
TNC FEMALE	92
TNC MALE	91
TNC MALE	92
TNC MALE RIGHT ANGLE	91
TNC MALE RIGHT ANGLE	92
1.85mm MALE	140
7/16 DIN MALE	140
BNC MALE	140
BNC MALE	141
BNC MALE RIGHT ANGLE	141
FAKRA JACK	141
FAKRA JACK	142
FAKRA JACK	141
FAKRA PLUG	141
HMCX32 1.2 PLUG	156
MC-Card PLUG	142
MINI UHF MALE	142
MMCX PLUG	142
MMCX PLUG RIGHT ANGLE	142
N FEMALE	144
N FEMALE BULKHEAD	144
N FEMALE BULKHEAD	145

Cable Assembly Locator

Connector Type | Page

SMA Male To:	
N MALE.....	142
N MALE.....	143
N MALE.....	144
N MALE RIGHT ANGLE.....	144
NMO Mount Sexless.....	185
OMA MALE.....	145
REVERSE POLARITY SMA MALE.....	151
REVERSE POLARITY TNC MALE.....	155
REVERSE POLARITY TNC MALE.....	156
Reverse Thread SMA MALE.....	152
SMA FEMALE.....	149
SMA FEMALE.....	150
SMA FEMALE BULKHEAD.....	140
SMA FEMALE BULKHEAD.....	150
SMA FEMALE BULKHEAD.....	151
SMA MALE.....	139
SMA MALE.....	145
SMA MALE.....	146
SMA MALE.....	147
SMA MALE RIGHT ANGLE.....	140
SMA MALE RIGHT ANGLE.....	147
SMA MALE RIGHT ANGLE.....	148
SMA MALE RIGHT ANGLE.....	149
SMB JACK.....	152
SMB PLUG.....	152
SMB PLUG RIGHT ANGLE.....	152
SMC PLUG.....	152
SMC PLUG.....	153
SMP FEMALE.....	153
SMP FEMALE RIGHT ANGLE.....	153
SSMA MALE.....	153
SSMC JACK.....	154
SSMC JACK BULKHEAD.....	154
SSMC PLUG.....	153
SSMC PLUG RIGHT ANGLE.....	153
TNC FEMALE.....	155
TNC FEMALE BULKHEAD.....	155
TNC MALE.....	140
TNC MALE.....	154
TNC MALE.....	155
TNC MALE RIGHT ANGLE.....	155
UMCX 2.1 PLUG.....	156
UMCX 2.5 PLUG.....	156
UMCX PLUG.....	156
WMCX 1.6 PLUG.....	156
SMA Male Right Angle To:	
N FEMALE.....	91
N FEMALE.....	92
N MALE.....	91
N MALE.....	92
N MALE RIGHT ANGLE.....	91
N MALE RIGHT ANGLE.....	92
SMA FEMALE.....	91
SMA MALE RIGHT ANGLE.....	91
SMA MALE RIGHT ANGLE.....	92
SMA MALE RIGHT ANGLE.....	93
TNC FEMALE.....	91
TNC FEMALE.....	92
TNC MALE.....	91
TNC MALE.....	92
TNC MALE RIGHT ANGLE.....	91
TNC MALE RIGHT ANGLE.....	92
BNC FEMALE BULKHEAD.....	158
BNC MALE.....	158
MCX JACK.....	158
MCX PLUG RIGHT ANGLE.....	158
MMCX PLUG RIGHT ANGLE.....	158
N FEMALE BULKHEAD.....	159
N MALE.....	158
N MALE.....	159
N MALE RIGHT ANGLE.....	159
REVERSE POLARITY SMA FEMALE.....	162
REVERSE POLARITY SMA MALE RIGHT ANGLE.....	162
SMA FEMALE.....	161
SMA FEMALE BULKHEAD.....	157
SMA FEMALE BULKHEAD.....	158
SMA FEMALE BULKHEAD.....	161
SMA FEMALE BULKHEAD.....	162
SMA MALE.....	159
SMA MALE RIGHT ANGLE.....	157
SMA MALE RIGHT ANGLE.....	160
SMA MALE RIGHT ANGLE.....	161
SMB PLUG.....	162

Connector Type | Page

SMB PLUG RIGHT ANGLE.....	162
SMC PLUG RIGHT ANGLE.....	162
SSMC JACK BULKHEAD.....	162
SSMC PLUG.....	162
SSMC PLUG RIGHT ANGLE.....	162
TNC FEMALE BULKHEAD.....	163
TNC MALE.....	158
TNC MALE.....	162
TNC MALE.....	163
TNC MALE RIGHT ANGLE.....	163
SMB Plug To:	
BNC MALE.....	171
N FEMALE.....	171
SMB JACK BULKHEAD.....	172
SMB PLUG.....	171
SMB PLUG RIGHT ANGLE.....	171
SMB PLUG RIGHT ANGLE.....	172
SMB Plug Right Angle To:	
BNC MALE.....	172
SMB JACK BULKHEAD.....	172
SMB JACK BULKHEAD.....	173
SMB PLUG RIGHT ANGLE.....	172
SSMB PLUG.....	173
SMC Plug To:	
10-32 MALE RIGHT ANGLE.....	173
BNC MALE.....	173
MCX PLUG.....	173
SMA MALE.....	173
SMC JACK BULKHEAD.....	174
SMC PLUG.....	173
SMC PLUG RIGHT ANGLE.....	173
SMC PLUG RIGHT ANGLE.....	174
SMC Plug Right Angle To:	
BNC MALE.....	174
SMC JACK BULKHEAD.....	174
SMC PLUG RIGHT ANGLE.....	174
TNC FEMALE BULKHEAD.....	174
SMP Female To:	
SMA MALE.....	174
SMP FEMALE.....	174
SMP FEMALE.....	175
SMP FEMALE RIGHT ANGLE.....	175
SMP Female Right Angle To:	
MMCX PLUG RIGHT ANGLE.....	175
N FEMALE BULKHEAD.....	175
REVERSE POLARITY TNC FEMALE BULKHEAD.....	175
SMA FEMALE.....	175
SMA MALE RIGHT ANGLE.....	175
SMP FEMALE.....	175
SMP FEMALE RIGHT ANGLE.....	175
SMP Male Bulkhead To:	
SMA MALE.....	174
SSMA Male To:	
SSMA MALE.....	175
SSMA MALE RIGHT ANGLE.....	175
SSMA Male Right Angle To:	
SSMA MALE RIGHT ANGLE.....	175
SSMB Plug To:	
SMA MALE.....	176
SSMB PLUG.....	176
SSMB Plug Right Angle To:	
SSMB PLUG RIGHT ANGLE.....	176
SSMC Jack Bulkhead To:	
SSMC JACK RIGHT ANGLE BULKHEAD.....	177
SSMC Jack Right Angle Bulkhead To:	
SSMC JACK RIGHT ANGLE BULKHEAD.....	177
SSMC Plug To:	
SMB JACK BULKHEAD.....	176
SSMC JACK BULKHEAD.....	176
SSMC PLUG.....	176
SSMC PLUG RIGHT ANGLE.....	176
SSMC Plug Right Angle To:	
SMA MALE.....	176
SSMC JACK BULKHEAD.....	177
SSMC PLUG RIGHT ANGLE.....	176
TNC FEMALE BULKHEAD.....	177

Connector Type | Page

TNC Female To:	
N FEMALE.....	92
N MALE.....	92
N MALE RIGHT ANGLE.....	92
TNC FEMALE.....	92
TNC MALE RIGHT ANGLE.....	92
NMO Mount Sexless.....	185
SMA MALE.....	181
TNC MALE.....	182
TNC Female Bulkhead To:	
MCX PLUG RIGHT ANGLE.....	182
MMCX PLUG RIGHT ANGLE.....	182
N FEMALE BULKHEAD.....	182
N MALE.....	182
N MALE RIGHT ANGLE.....	182
SMA MALE RIGHT ANGLE.....	182
SMC PLUG RIGHT ANGLE.....	182
SMP FEMALE RIGHT ANGLE.....	182
SSMC PLUG RIGHT ANGLE.....	182
TNC FEMALE BULKHEAD.....	183
TNC MALE.....	183
TNC MALE RIGHT ANGLE.....	183
UMCX PLUG RIGHT ANGLE.....	183
TNC Male To:	
N FEMALE.....	92
N MALE.....	92
N MALE RIGHT ANGLE.....	92
TNC FEMALE.....	92
TNC MALE.....	91
TNC MALE.....	92
TNC MALE RIGHT ANGLE.....	92
BNC MALE.....	177
MINI UHF MALE.....	177
N FEMALE BULKHEAD.....	178
N MALE.....	178
N MALE RIGHT ANGLE.....	178
REVERSE POLARITY TNC MALE.....	180
SMA MALE.....	178
SMA MALE RIGHT ANGLE.....	178
SMB PLUG RIGHT ANGLE.....	178
SMP FEMALE RIGHT ANGLE.....	178
TNC FEMALE.....	180
TNC FEMALE BULKHEAD.....	180
TNC MALE.....	177
TNC MALE.....	178
TNC MALE.....	179
TNC MALE.....	180
TNC MALE RIGHT ANGLE.....	180
TNC Male Right Angle To:	
N FEMALE.....	92
N MALE.....	92
N MALE RIGHT ANGLE.....	92
TNC MALE RIGHT ANGLE.....	92
N FEMALE BULKHEAD.....	181
N MALE.....	181
N MALE RIGHT ANGLE.....	181
TNC FEMALE.....	181
TNC FEMALE BULKHEAD.....	181
TNC MALE.....	181
TNC MALE RIGHT ANGLE.....	181
UHF Male To:	
BNC MALE.....	183
BNC MALE.....	184
UHF MALE.....	184
UMCX 2.1 Plug To:	
UMCX 2.1 PLUG.....	184
UMCX 2.5 Plug To:	
UMCX 2.5 PLUG.....	184
UMCX Plug Right Angle To:	
MCX JACK BULKHEAD.....	184
MCX PLUG.....	184
MCX PLUG RIGHT ANGLE.....	184
MMCX PLUG RIGHT ANGLE.....	184
WMCX 1.6 Plug To:	
WMCX 1.6 PLUG.....	184

Cable Assemblies

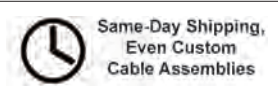
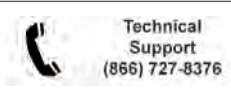

HIGH-RELIABILITY RF CABLE ASSEMBLIES

Product Features

- Max. Frequency as High as 18 GHz
- Double and Triple Shielded Versions
- Lot Traceability
- J-STD-Soldering
- High-Reliability Cable and Connectors
- RF Test Plots
- Detailed Test Report
- In-Stock and Shipped Same Day

Applications

- Hi-Rel
- MIL-DTL-17 Requirements
- Avionics
- IFF
- SATCOM
- ECM



MIL-DTL-17 Cable Assembly Series



Temperature Conditioned, Low Loss Cable Assembly Series

Pasternack's MIL-DTL-17 Cable Assemblies and Temperature-Conditioned, Low-Loss Cable Assemblies are part of a full line of high-reliability RF components that are in-stock and available for shipment same day. These Commercial-Off-The-Shelf (COTS) assemblies offer a combination of superior materials, processes, and acceptance testing designed to ensure rugged, highly reliable performance for your mission critical applications.

Each assembly is manufactured using J-STD soldering processes and WHMA-A-620 workmanship and is also traceable to its component lots for every material used (RF connectors, coax cable, heat shrink, and solder). There is 100% test sampling of assemblies for connector gaging, insertion loss, VSWR, DWV, workmanship, configuration, and marking, with sampled (AQL) inspections performed for length and mass. A detailed test report accompanies each assembled lot.

Whether the need is to provide a high-reliability MIL-SPEC connection or a rugged, dependable cable assembly, Pasternack has the right assembly for the job. Visit us online at www.pasternack.com to configure and customize your order, or sign up for our mailing list to receive the latest news and product information.

MIL-DTL-17 BNC CABLE ASSEMBLY SERIES

Model No	Cable Type	Velocity of Propagation (%)	Connector 1	Connector 2	Frequency Max. (GHz)	ROW
M17/28-RG058						
PE3M0115	M17/28-RG058	65.9	BNC, Male	BNC, Male	1	1
PE3M0116				SMA, Male		2
PE3M0117				SMA, Male, RA		3
PE3M0118				TNC, Male		4
M17/60-RG142						
PE3M0001	M17/60-RG142	69.5	BNC, Male	BNC, Male	4	5
PE3M0002				N, Male		6
PE3M0003				N, Female		7
PE3M0004				SMA, Male		8
PE3M0005				SMA, Male, RA		9
PE3M0006				SMA, Male, RA		10
PE3M0007				TNC, Male		11
M17/84-RG223						
PE3M0029	M17/84-RG223	65.9	BNC, Male	BNC, Male	4	12
PE3M0030				N, Male		13
PE3M0031				N, Female		14
PE3M0032				SMA, Male		15
PE3M0033				SMA, Male, RA		16
PE3M0034				TNC, Male		17
PE3M0035	TNC, Male	18				
M17/113-RG316						
PE3M0085	M17/113-RG316	69.5	BNC, Male	BNC, Male	3	19
PE3M0086				SMA, Male		20
PE3M0087				SMA, Male, RA		21
PE3M0088				SMA, Female		22
PE3M0089				TNC, Male		23
M17/119-RG174						
PE3M0100	M17/119-RG174	65.9	BNC, Male	BNC, Male	1	24
PE3M0101				SMA, Male		25
PE3M0102				SMA, Male, RA		26
PE3M0103				SMA, Female		27
PE3M0104				TNC, Male		28
M17/128-RG400						
PE3M0057	M17/128-RG400	69.5	BNC, Male	BNC, Male	4	29
PE3M0058				N, Male		30
PE3M0059				N, Female		31
PE3M0060				SMA, Male		32
PE3M0061				SMA, Male, RA		33
PE3M0062				SMA, Male, RA		34
PE3M0063				TNC, Male		35

MIL-DTL-17 N TYPE CABLE ASSEMBLY SERIES

Model No	Cable Type	Velocity of Propagation (%)	Connector 1	Connector 2	Frequency Max. (GHz)	ROW
M17/60-RG142						
PE3M0008	M17/60-RG142	69.5	N, Male	N, Male	11	36
PE3M0009				N, Female		37
PE3M0010				N, Female		38
PE3M0014				SMA, Male		39
PE3M0015				SMA, Male, RA		40
PE3M0016				TNC, Male		41
PE3M0011				N, Female		42
PE3M0012				N, Female		43
PE3M0013				N, Female		44
PE3M0017				SMA, Male		45
PE3M0020				SMA, Male, RA		46
PE3M0018	SMA, Male, RA	47				
PE3M0021	TNC, Male	48				
PE3M0019	TNC, Male	49				
PE3M0022	TNC, Male	50				
M17/84-RG223						
PE3M0036	M17/84-RG223	65.9	N, Male	N, Male	11	51
PE3M0037				N, Female		52
PE3M0038				SMA, Male		53
PE3M0042				SMA, Male, RA		54
PE3M0043				SMA, Male, RA		55
PE3M0044				TNC, Male		56
PE3M0039				N, Female		57
PE3M0040				N, Female		58
PE3M0041				N, Female		59
PE3M0045				SMA, Male		60
PE3M0048				SMA, Male, RA		61
PE3M0046				SMA, Male, RA		62
PE3M0049				SMA, Male, RA		63
PE3M0047				TNC, Male		64
PE3M0050				TNC, Male		65
M17/128-RG400						
PE3M0064	M17/128-RG400	69.5	N, Male	N, Male	11	66
PE3M0065				N, Female		67
PE3M0066				N, Female		68
PE3M0070				SMA, Male		69
PE3M0071				SMA, Male, RA		70
PE3M0072				TNC, Male		71
PE3M0067				N, Female		72
PE3M0068				N, Female		73

Cable Assemblies

See Our Website For Current Pricing & Real-Time Stock Availability!

For our complete selection of cable assemblies, please visit our website

MIL-DTL-17 N TYPE CABLE ASSEMBLY SERIES						
Model No	Cable Type	Velocity of Propagation (%)	Connector 1	Connector 2	Frequency Max. (GHz)	ROW
M17/128-RG400						
PE3M0069	M17/128-RG400	69.5	N, Female	N, Female	11	74
PE3M0073				SMA, Male		75
PE3M0076				SMA, Male, RA		76
PE3M0074				SMA, Male, RA		77
PE3M0077				TNC, Male		78
PE3M0075						79
PE3M0078						80

MIL-DTL-17 SMA CABLE ASSEMBLY SERIES							
Model No	Cable Type	Velocity of Propagation (%)	Connector 1	Connector 2	Frequency Max. (GHz)	ROW	
M17/28-RG058							
PE3M0119	M17/28-RG058	65.9	SMA, Male	SMA, Male	1	81	
PE3M0120				SMA, Male, RA		82	
PE3M0122				TNC, Male		83	
PE3M0121				SMA, Male, RA		SMA, Male, RA	84
PE3M0123						TNC, Male	85

M17/60-RG142							
PE3M0023	M17/60-RG142	69.5	SMA, Male	SMA, Male	12.4	86	
PE3M0024				SMA, Male, RA		87	
PE3M0026				TNC, Male		88	
PE3M0025				SMA, Male, RA		SMA, Male, RA	89
PE3M0027						TNC, Male	90

M17/84-RG223							
PE3M0051	M17/84-RG223	65.9	SMA, Male	SMA, Male	12.4	91	
PE3M0052				SMA, Male, RA		92	
PE3M0054				TNC, Male		93	
PE3M0053				SMA, Male, RA		SMA, Male, RA	94
PE3M0055						TNC, Male	95

M17/113-RG316							
PE3M0090	M17/113-RG316	69.5	SMA, Male	SMA, Male	3	96	
PE3M0091				SMA, Male, RA		97	
PE3M0092				SMA, Female		98	
PE3M0096				TNC, Male		99	
PE3M0093				SMA, Male, RA		SMA, Male, RA	1
PE3M0094						SMA, Female	2
PE3M0097						TNC, Male	3
PE3M0095				SMA, Female		SMA, Female	4
PE3M0098						TNC, Male	5

M17/119-RG174							
PE3M0105	M17/119-RG174	65.9	SMA, Male	SMA, Male	1	6	
PE3M0106				SMA, Male, RA		7	
PE3M0107				SMA, Female		8	
PE3M0111				TNC, Male		9	
PE3M0108				SMA, Male, RA		SMA, Male, RA	10
PE3M0109						SMA, Female	11
PE3M0112						TNC, Male	12
PE3M0110				SMA, Female		SMA, Female	13
PE3M0113						TNC, Male	14

M17/128-RG400							
PE3M0079	M17/128-RG400	69.5	SMA, Male	SMA, Male	12.4	15	
PE3M0080				SMA, Male, RA		16	
PE3M0082				TNC, Male		17	
PE3M0081				SMA, Male, RA		SMA, Male, RA	18
PE3M0083						TNC, Male	19

MIL-DTL-17 TNC CABLE ASSEMBLY SERIES						
Model No	Cable Type	Velocity of Propagation (%)	Connector 1	Connector 2	Frequency Max. (GHz)	ROW
M17/28-RG058						
PE3M0124	M17/28-RG058	65.9	TNC, Male	TNC, Male	1	20
M17/60-RG142						
PE3M0028	M17/60-RG142	69.5	TNC, Male	TNC, Male	11	21
M17/84-RG223						
PE3M0056	M17/84-RG223	65.9	TNC, Male	TNC, Male	11	22
M17/113-RG316						
PE3M0099	M17/113-RG316	69.5	TNC, Male	TNC, Male	3	23

Model No	Cable Type	Velocity of Propagation (%)	Connector 1	Connector 2	Frequency Max. (GHz)	ROW
M17/119-RG174						
PE3M0114	M17/119-RG174	65.9	TNC, Male	TNC, Male	1	24
M17/128-RG400						
PE3M0084	M17/128-RG400	69.5	TNC, Male	TNC, Male	11	25

TEMPERATURE CONDITIONED, LOW LOSS N TYPE CABLE ASSEMBLY SERIES							
Model No	Cable Type	Velocity of Propagation (%)	Connector 1	Connector 2	Frequency Max. (GHz)	ROW	
PE-P142LL							
PE3M0174	PE-P142LL	80	N, Male	N, Male	18	26	
PE3M0176				N, Male, RA		27	
PE3M0175				N, Female		28	
PE3M0179				N, Male, RA		29	
PE3M0178				N, Female		N, Male, RA	30
PE3M0177						N, Female	31

PE-P160LL							
PE3M0219	PE-P160LL	82.5	N, Male	N, Male	18	32	
PE3M0221				N, Male, RA		33	
PE3M0220				N, Female		34	
PE3M0224				N, Male, RA		35	
PE3M0223				N, Female		N, Male, RA	36
PE3M0222						N, Female	37

PE-P300LL							
PE3M0247	PE-P300LL	83	N, Male	N, Male	18	38	
PE3M0249				N, Male, RA		39	
PE3M0248				N, Female		40	
PE3M0252				N, Male, RA		41	
PE3M0251				N, Female		N, Male, RA	42
PE3M0250						N, Female	43

TEMPERATURE CONDITIONED, LOW LOSS SMA CABLE ASSEMBLY SERIES							
Model No	Cable Type	Velocity of Propagation (%)	Connector 1	Connector 2	Frequency Max. (GHz)	ROW	
PE-P142LL							
PE3M0132	PE-P142LL	80	SMA, Male	N, Male	18	44	
PE3M0134				N, Male, RA		45	
PE3M0133				N, Female		46	
PE3M0125				SMA, Male		47	
PE3M0128				SMA, Male, RA		48	
PE3M0126				SMA, Female		49	
PE3M0127				SMA, Female		50	
PE3M0129				TNC, Male		51	
PE3M0131				TNC, Male, RA		52	
PE3M0130				TNC, Female		53	
PE3M0156				N, Male		54	
PE3M0158				N, Male, RA		55	
PE3M0157				N, Female		56	
PE3M0152				SMA, Male, RA		SMA, Male, RA	57
PE3M0153						TNC, Male	58
PE3M0155						TNC, Male, RA	59
PE3M0154				TNC, Female		TNC, Female	60
PE3M0141						61	
PE3M0149				N, Male		62	
PE3M0143				N, Male, RA		63	
PE3M0151				N, Female		64	
PE3M0142						65	
PE3M0150						66	
PE3M0137				SMA, Male, RA		67	
PE3M0145				SMA, Female		SMA, Female	68
PE3M0135						SMA, Female	69
PE3M0136						SMA, Female	70
PE3M0144						TNC, Male	71
PE3M0138						TNC, Male, RA	72
PE3M0146						TNC, Male	73
PE3M0140						TNC, Male, RA	74
PE3M0148						TNC, Female	75
PE3M0139							76
PE3M0147						77	

PE-P160LL						
PE3M0186	PE-P160LL	82.5	SMA, Male	N, Male	18	78
PE3M0188				N, Male, RA		79
PE3M0187				N, Female		80

Cable Assemblies

See Our Website For Current Pricing & Real-Time Stock Availability!

For Custom Lengths, Metric Lengths or Special Configurations, Please call (949) 261-1920

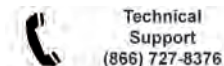

For our complete selection of cable assemblies, please visit our website

Model No	Cable Type	Velocity of Propagation (%)	Connector 1	Connector 2	Frequency Max. (GHz)	R O W
PE-P160LL						
PE3M0180	PE-P160LL	82.5	SMA, Male	SMA, Male	18	81
PE3M0182				SMA, Male, RA		82
PE3M0181				SMA, Female		83
PE3M0183				TNC, Male		84
PE3M0185				TNC, Male, RA		85
PE3M0184				TNC, Female		86
PE3M0201				N, Male		87
PE3M0203				N, Male, RA		88
PE3M0202				N, Female		89
PE3M0197				SMA, Male, RA		90
PE3M0198			TNC, Male	91		
PE3M0200			TNC, Male, RA	92		
PE3M0199			TNC, Female	93		
PE3M0194			N, Male	94		
PE3M0196			N, Male, RA	95		
PE3M0195			N, Female	96		
PE3M0190			SMA, Male, RA	97		
PE3M0189			SMA, Female	98		
PE3M0191			TNC, Male	99		
PE3M0193			TNC, Male, RA	1		
PE3M0192	TNC, Female	2				
PE-P300LL						
PE3M0229	PE-P300LL	83	SMA, Male	N, Male	18	3
PE3M0231				N, Male, RA		4
PE3M0230				N, Female		5
PE3M0225				SMA, Male		6
PE3M0226				SMA, Male, RA		7
PE3M0227				TNC, Male		8
PE3M0228				TNC, Male, RA		9
PE3M0235				N, Male		10
PE3M0237				N, Male, RA		11
PE3M0236				N, Female		12
PE3M0232			SMA, Male, RA	13		
PE3M0233			TNC, Male	14		
PE3M0234			TNC, Male, RA	15		

TEMPERATURE CONDITIONED,
LOW LOSS TNC CABLE ASSEMBLY SERIES

Model No	Cable Type	Velocity of Propagation (%)	Connector 1	Connector 2	Frequency Max. (GHz)	R O W
PE-P142LL						
PE3M0162	PE-P142LL	80	TNC, Male	N, Male	18	16

Model No	Cable Type	Velocity of Propagation (%)	Connector 1	Connector 2	Frequency Max. (GHz)	R O W			
PE-P142LL									
PE3M0164	PE-P142LL	80	TNC, Male	N, Male, RA	18	17			
PE3M0163				N, Female		18			
PE3M0159				TNC, Male		19			
PE3M0161				TNC, Male, RA		20			
PE3M0160				TNC, Female		21			
PE3M0171				N, Male		22			
PE3M0173				N, Male, RA		23			
PE3M0172				N, Female		24			
PE3M0170				TNC, Male, RA		25			
PE3M0167				N, Male		26			
PE3M0169			N, Male, RA	27					
PE3M0168			N, Female	28					
PE3M0166			TNC, Male, RA	29					
PE3M0165			TNC, Female	30					
PE-P160LL									
PE3M0207			PE-P160LL	82.5		TNC, Male	N, Male	18	31
PE3M0209							N, Male, RA		32
PE3M0208							N, Female		33
PE3M0204							TNC, Male		34
PE3M0206							TNC, Male, RA		35
PE3M0205	TNC, Female	36							
PE3M0216	N, Male	37							
PE3M0218	N, Male, RA	38							
PE3M0217	N, Female	39							
PE3M0215	TNC, Male, RA	40							
PE3M0212	N, Male	41							
PE3M0214	N, Male, RA	42							
PE3M0213	N, Female	43							
PE3M0211	TNC, Male, RA	44							
PE3M0210	TNC, Female	45							
PE-P300LL									
PE3M0240	PE-P300LL	83			TNC, Male	N, Male	18		46
PE3M0242						N, Male, RA			47
PE3M0241						N, Female			48
PE3M0238						TNC, Male			49
PE3M0239			TNC, Male, RA	50					
PE3M0244			N, Male	51					
PE3M0246			N, Male, RA	52					
PE3M0245			N, Female	53					
PE3M0243			TNC, Male, RA	54					

Cable Assemblies

See Our Website For Current Pricing & Real-Time Stock Availability!

LOW PIM CABLE ASSEMBLIES

Product Features

- 100% PIM Tested, Results Marked on Cable
- Max Frequency 6 GHz
- Low PIM: < -160 dBc Max
- 76% Phase Velocity
- FEP Jacket
- UL910 Plenum-Rated Cable
- Lightweight and Extremely Flexible
- Low Loss with Excellent VSWR

- IP67 (when mated)
- Shielding Effectivity > 100 dB
- Connector Options: 4.3-10, SMA, QMA, 7/16 DIN, 4.1/9.5, Type-N

Applications

- Low PIM Applications
- Distributed Antenna Systems (DAS)
- Plenum Installations
- Multi-Carrier Communication Systems
- PIM Testing



Low PIM Cable Assemblies

Pasternack's Low PIM Cable Assemblies offer a wide range of connector options: 4.3-10, SMA, QMA, 7/16 DIN, 4.1/9.5, and Type-N. These assemblies deliver low PIM performance to support Distributed Antenna Systems (DAS) and other complex, multi-carrier cable installations. All low PIM assemblies are 100% PIM tested with test results marked on the cable.

Whether the need is to provide a low PIM jumper connection, low PIM test cable, or simply create a custom assembly, Pasternack has the right cable for the job. Low PIM assemblies are part of Pasternack's full line of RF components that are available for same-day shipping. We are continually adding new cables and connectors to the low PIM family. So please visit us online at www.pasternack.com to see the newest additions, or sign up for our mailing list to receive the latest news and product information.

For our complete selection of cable assemblies, please visit our website

4.1/9.5 MINI DIN LOW PIM PLENUM RATED CABLE ASSEMBLY SERIES

Model No	Cable Type	Velocity of Propagation (%)	Connector 1	Connector 2	Freq. Max. (GHz)	PIM (dBc)	R O W	
SPP-250-LLPL								
PE3C4143	SPP-250-LLPL	76	4.1/9.5 Mini DIN, Male	4.1/9.5 Mini DIN, Male	5.8	-160	1	
PE3C5847				4.1/9.5 Mini DIN, Male, RA			2	
PE3C5841				4.1/9.5 Mini DIN, Female			3	
PE3C5834				4.3-10, Female			4	
PE3C4134				7/16 DIN, Male			5	
PE3C5854				7/16 DIN, Female			6	
PE3W07481				N, Female			7	
PE3C5866				OMA, Male			8	
PE3C5872				OMA, Male, RA			9	
PE3C5860				OMA, Female			10	
PE3C5885				SMA, Male			11	
PE3C5890				SMA, Male, RA			12	
PE3C5879				SMA, Female			13	
PE3C5852				4.1/9.5 Mini DIN, Male, RA			-160	14
PE3C5846				4.3-10, Male				15
PE3C5950				4.3-10, Female				16
PE3C5848				7/16 DIN, Male				17
PE3C5849				N, Male				18
PE3C5850				OMA, Male				19
PE3C5851				SMA, Male				20
PE3C5840				4.3-10, Male				21
PE3C5842				7/16 DIN, Male				22
PE3C5843				N, Male				23
PE3C5844				OMA, Male				24
PE3C5845				SMA, Male				25
PE-SR402FLJ Low PIM								
PE3C2009	PE-SR402FLJ Low PIM	70	4.1/9.5 Mini DIN, Male	4.1/9.5 Mini DIN, Female	3	-160		26
PE3C2010								27

4.3/10 DIN LOW PIM PLENUM RATED CABLE ASSEMBLY SERIES

Model No	Cable Type	Velocity of Propagation (%)	Connector 1	Connector 2	Freq. Max. (GHz)	PIM (dBc)	R O W			
SPP-250-LLPL										
PE3C4142	SPP-250-LLPL	76	4.3-10, Male	4.3-10, Male	5.8	-160	28			
PE3C5833				4.3-10, Female			29			
PE3C4135				7/16 DIN, Male			30			
PE3C5853				7/16 DIN, Female			31			
PE3C5865				OMA, Male			32			
PE3C5871				OMA, Male, RA			33			
PE3C5859				OMA, Female			34			
PE3C5884				SMA, Male			35			
PE3C5889				SMA, Male, RA			36			
PE3C5878				SMA, Female			37			
PE3C4147				4.3-10, Male, RA			6	4.3-10, Male	-160	38
PE3C4146								4.3-10, Male, RA		39
PE3C5836								7/16 DIN, Male		40
PE3C5837								N, Male		41
PE3C5838								OMA, Male		42
PE3C5839								SMA, Male		43

7/16 DIN LOW PIM PLENUM RATED CABLE ASSEMBLY SERIES

Model No	Cable Type	Velocity of Propagation (%)	Connector 1	Connector 2	Freq. Max. (GHz)	PIM (dBc)	R O W			
SPP-250-LLPL										
PE3C4130	SPP-250-LLPL	76	7/16 DIN, Male	7/16 DIN, Male	5.8	-160	44			
PE3C5855				7/16 DIN, Female			45			
PE3C5867				OMA, Male			46			
PE3C5873				OMA, Male, RA			47			
PE3C5861				OMA, Female			48			
PE3C5886				SMA, Male			49			
PE3C5891				SMA, Male, RA			50			
PE3C5880				SMA, Female			51			
PE3C4131				7/16 DIN, Male, RA			7/16 DIN, Male	6	-160	52

Model No	Cable Type	Velocity of Propagation (%)	Connector 1	Connector 2	Freq. Max. (GHz)	PIM (dBc)	R O W
SPP-250-LLPL							
PE3C4144	SPP-250-LLPL	76	7/16 DIN, Male, RA	7/16 DIN, Male, RA	6	-160	53
PE3C5856				N, Male			54
PE3C5857				OMA, Male			55
PE3C5858				SMA, Male			56
PE-SR402FLJ Low PIM							
PE3C2003	PE-SR402FLJ Low PIM	70	7/16 DIN, Male	7/16 DIN, Female	3	-160	57
PE3C2004							58
PE-SR401FLJ Low PIM							
PE3C2013	PE-SR401FLJ Low PIM	70	7/16 DIN, Male	7/16 DIN, Female	3	-160	59
PE3C2015							60

OMA LOW PIM PLENUM RATED CABLE ASSEMBLY SERIES

Model No	Cable Type	Velocity of Propagation (%)	Connector 1	Connector 2	Freq. Max. (GHz)	PIM (dBc)	R O W		
SPP-250-LLPL									
PE3C5869	SPP-250-LLPL	76	OMA, Male	OMA, Male	5.8	-150	61		
PE3C5875				OMA, Male, RA			62		
PE3C5863				OMA, Female			63		
PE3C5870				SMA, Male			64		
PE3C5893				SMA, Male, RA			65		
PE3C5882				SMA, Female			66		
PE3C5877				OMA, Male, RA			67		
PE3C5876				OMA, Male, RA			68		
PE3C5864				OMA, Female			SMA, Male	-150	69

SMA LOW PIM PLENUM RATED CABLE ASSEMBLY SERIES

Model No	Cable Type	Velocity of Propagation (%)	Connector 1	Connector 2	Freq. Max. (GHz)	PIM (dBc)	R O W
SPP-250-LLPL							
PE3C5888	SPP-250-LLPL	76	SMA, Male	SMA, Male	5.8	-155	70
PE3C5894				SMA, Male, RA			71
PE3C5883				SMA, Female			72
PE3C5895				SMA, Male, RA			SMA, Male, RA
PE-SR402FLJ Low PIM							
PE3C2007	PE-SR402FLJ Low PIM	70	SMA, Male	7/16 DIN, Male	3	-150	74
PE3C2008				SMA, Male	6		75

TYPE N LOW PIM PLENUM RATED CABLE ASSEMBLY SERIES

Model No	Cable Type	Velocity of Propagation (%)	Connector 1	Connector 2	Freq. Max. (GHz)	PIM (dBc)	R O W							
SPP-250-LLPL														
PE3C4140	SPP-250-LLPL	76	N, Male	4.1/9.5 Mini DIN, Male	5.8	-160	76							
PE3C4141				4.3-10, Male			77							
PE3C4132				7/16 DIN, Male			78							
PE3C4136				7/16 DIN, Male, RA			79							
PE3C4137				N, Male			80							
PE3C5868				OMA, Male			-150	81						
PE3C5874				OMA, Male, RA			-145	82						
PE3C5862				OMA, Female			-150	83						
PE3C5887				SMA, Male			-155	84						
PE3C5892				SMA, Male, RA			-155	85						
PE3C5881				SMA, Female			-155	86						
PE3C4139				N, Male, RA			6	N, Male	6	-160	87			
PE3C4145								N, Male, RA	5.8	88				
PE3C4133								7/16 DIN, Male	6	89				
PE3C4138								N, Male	5.8	90				
PE3W07489								N, Female	5.8	91				
PE-SR402FLJ Low PIM														
PE3C2002								PE-SR402FLJ Low PIM	70	N, Male	7/16 DIN, Male	3	-160	92
PE3C2005											7/16 DIN, Female			93
PE3C2000											N, Male			94
PE3C2001					N, Female	6		-150	95					
PE3C2006					SMA, Male				96					
PE-SR401FLJ Low PIM														
PE3C2012	PE-SR401FLJ Low PIM	70	N, Male		7/16 DIN, Male	3		-160	97					
PE3C2014					7/16 DIN, Female				98					
PE3C2011					N, Male				99					

Cable Assemblies

See Our Website For Current Pricing & Real-Time Stock Availability!



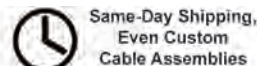
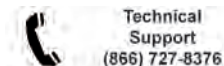





For Custom Lengths, Metric Lengths or Special Configurations, Please call (949) 261-1920







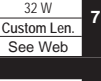

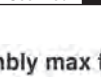
For our complete selection of cable assemblies, please visit our website

Cable Assemblies







See Our Website For Current Pricing & Real-Time Stock Availability!



1.0/2.3 PLUG TO BNC FEMALE BULKHEAD								
SEE MOUNTING HOLE SECTION ON PAGE 369								
Flexible Cable Assemblies								
LMR-100A-PVC Coax, 50 Ohm								
Part No. PE3W05192	Cable Dia.			Attn. @ 1 GHz	Power @ 1 GHz			
1 piece price shown. See web or call for volume pricing.								
12"	24"	36"	48"	60"	50CM	Custom Len.		
\$37.62	\$38.35	\$39.08	\$39.80	\$40.53	\$38.09	See Web	1	
1.0/2.3 PLUG RIGHT ANGLE TO BNC MALE								
Standard Flexible Cable Assemblies								
RG316/U Coax, 50 Ohm								
Part No. PE3C3469	Cable Dia.			Attn. @ 1 GHz	Power @ 1 GHz			
1 piece price shown. See web or call for volume pricing.								
12"	24"	36"	48"	60"	50CM	Custom Len.		
\$42.95	\$45.99	\$49.02	\$52.05	\$55.09	\$44.90	See Web	2	
1.0/2.3 JACK BULKHEAD TO 1.0/2.3 JACK BULKHEAD								
SEE MOUNTING HOLE SECTION ON PAGE 369								
Standard Flexible Cable Assemblies								
RG316/U Coax, 50 Ohm								
Part No. PE3C0441	Cable Dia.			Attn. @ 1 GHz	Power @ 1 GHz			
1 piece price shown. See web or call for volume pricing.								
12"	24"	36"	48"	60"	72"	Custom Len.		
\$47.57	\$50.45	\$53.35	\$56.27	\$59.17	\$62.06	See Web	3	
1.0MM MALE TO 1.0MM MALE								
Precision Flexible Cable Assemblies								
PE-110TC Coax, 50 Ohm								
Part No. PE3TC1220	Cable Dia.			Attn. @ 1 GHz	Power @ 1 GHz			
1 piece price shown. See web or call for volume pricing.								
6"	12"	-	-	-	-	Custom Len.		
\$5,878.91	\$7,867.15	-	-	-	-	See Web	4	
1.85MM MALE TO 1.85MM MALE								
Precision Flexible Cable Assemblies								
PE-VNA-HF Coax, 50 Ohm								
Part No. PE3TC0800	Cable Dia.			Attn. @ 1 GHz	Power @ 1 GHz			
1 piece price shown. See web or call for volume pricing.								
24"	36"	48"	-	-	-	Custom Len.		
\$2,884.71	\$2,922.71	\$3,024.63	-	-	-	See Web	5	
1.85MM MALE TO 1.85MM MALE								
Low Loss Flexible Cable Assemblies								
PE-P106LL Coax, 50 Ohm								
Part No. PE3C5998	Cable Dia.			Attn. @ 1 GHz	Power @ 1 GHz			
1 piece price shown. See web or call for volume pricing.								
6"	12"	24"	36"	50CM	100CM	Custom Len.		
\$569.77	\$591.67	\$591.11	\$650.08	\$571.73	\$669.73	See Web	6	
2.4MM MALE TO 1.85MM MALE								
Standard Formable Cable Assemblies								
PE-SR405FLJ Coax, 50 Ohm								
Part No. PE3W08014	Cable Dia.			Attn. @ 1 GHz	Power @ 1 GHz			
1 piece price shown. See web or call for volume pricing.								
12"	18"	24"	36"	48"	60"	Custom Len.		
\$253.65	\$257.96	\$262.27	\$270.89	\$279.51	\$288.13	See Web	15	
2.4MM MALE TO 2.4MM MALE								
Precision Flexible Cable Assemblies								
PE-VNA-HF Coax, 50 Ohm								
Part No. PE3TC0751	Cable Dia.			Attn. @ 1 GHz	Power @ 1 GHz			
1 piece price shown. See web or call for volume pricing.								
12"	24"	36"	48"	60"	50CM	Custom Len.		
\$172.28	\$180.21	\$188.15	\$196.56	\$184.42	\$166.03	See Web	16	
2.4MM MALE TO 2.4MM MALE								
Standard Flexible Cable Assemblies								
PE-P086 Coax, 50 Ohm								
Part No. PE3C0751	Cable Dia.			Attn. @ 1 GHz	Power @ 1 GHz			
1 piece price shown. See web or call for volume pricing.								
12"	24"	36"	48"	60"	50CM	Custom Len.		
\$172.28	\$180.21	\$188.15	\$196.56	\$184.42	\$166.03	See Web	16	
2.4MM MALE TO 2.4MM MALE								
Test Flexible Cable Assemblies								
PE-P160 Coax, 50 Ohm								
Part No. PE363	Cable Dia.			Attn. @ 1 GHz	Power @ 1 GHz			
1 piece price shown. See web or call for volume pricing.								
36"	48"	100CM	150CM	-	-	Custom Len.		
\$339.32	\$365.21	\$346.59	\$389.07	-	-	See Web	18	
1.85MM MALE TO 1.85MM MALE								
Standard Flexible Cable Assemblies								
PE-VNA-R Coax, 50 Ohm								
Part No. PE3VNA4004	Cable Dia.			Attn. @ 1 GHz	Power @ 1 GHz			
1 piece price shown. See web or call for volume pricing.								
24"	48"	-	-	-	-	Custom Len.		
\$1,972.35	\$2,175.54	-	-	-	-	See Web	19	
1.85MM MALE TO 1.85MM MALE								
Standard Flexible Cable Assemblies								
PE-P086HF Coax, 50 Ohm								
Part No. PE3C0728	Cable Dia.			Attn. @ 1 GHz	Power @ 1 GHz			
1 piece price shown. See web or call for volume pricing.								
6"	12"	18"	24"	36"	48"	Custom Len.		
\$204.89	\$208.17	\$211.55	\$214.94	\$221.70	\$228.85	See Web	20	
1.85MM MALE TO 1.85MM MALE								
Standard Semi-Rigid Cable Assemblies								
PE-SR405AL Coax, 50 Ohm								
Part No. PE35672	Cable Dia.			Attn. @ 1 GHz	Power @ 1 GHz			
1 piece price shown. See web or call for volume pricing.								
6"	12"	18"	24"	36"	48"	Custom Len.		
\$160.94	\$165.56	\$160.52	\$164.84	\$173.49	\$194.66	See Web	21	

RG405/U Coax, 50 Ohm								
Part No. PE36523	Cable Dia.			Attn. @ 1 GHz	Power @ 1 GHz			
1 piece price shown. See web or call for volume pricing.								
6"	12"	18"	24"	36"	48"	Custom Len.		
\$332.12	\$332.12	\$335.55	\$338.98	\$345.85	\$352.72	See Web	11	
Skew Matched Pair Flexible Cable Assemblies								
PE-P106LL Coax, 50 Ohm								
Part No. PE3C5835	Cable Dia.			Attn. @ 1 GHz	Power @ 1 GHz			
1 piece price shown. See web or call for volume pricing.								
12"	24"	36"	48"	-	-	Custom Len.		
\$3,121.16	\$3,326.18	\$4,002.92	\$4,205.18	-	-	See Web	12	
1.85MM MALE TO 1.85MM MALE RIGHT ANGLE								
Precision Flexible Cable Assemblies								
PE-VNA-HF Coax, 50 Ohm								
Part No. PE3TC1000	Cable Dia.			Attn. @ 1 GHz	Power @ 1 GHz			
1 piece price shown. See web or call for volume pricing.								
24"	48"	-	-	-	-	Custom Len.		
\$3,355.10	\$3,498.00	-	-	-	-	See Web	13	
1.85MM MALE TO 1.85MM FEMALE								
Precision Flexible Cable Assemblies								
PE-VNA-HF Coax, 50 Ohm								
Part No. PE3TC0900	Cable Dia.			Attn. @ 1 GHz	Power @ 1 GHz			
1 piece price shown. See web or call for volume pricing.								
24"	36"	48"	-	-	-	Custom Len.		
\$2,884.71	\$2,922.71	\$3,024.63	-	-	-	See Web	14	
2.4MM MALE TO 1.85MM MALE								
Standard Formable Cable Assemblies								
PE-SR405FLJ Coax, 50 Ohm								
Part No. PE3W08014	Cable Dia.			Attn. @ 1 GHz	Power @ 1 GHz			
1 piece price shown. See web or call for volume pricing.								
12"	18"	24"	36"	48"	60"	Custom Len.		
\$253.65	\$257.96	\$262.27	\$270.89	\$279.51	\$288.13	See Web	15	
2.4MM MALE TO 1.85MM MALE								
Standard Flexible Cable Assemblies								
PE-P086 Coax, 50 Ohm								
Part No. PE3C0751	Cable Dia.			Attn. @ 1 GHz	Power @ 1 GHz			
1 piece price shown. See web or call for volume pricing.								
12"	24"	36"	48"	60"	50CM	Custom Len.		
\$172.28	\$180.21	\$188.15	\$196.56	\$184.42	\$166.03	See Web	16	
2.4MM MALE TO 2.4MM MALE								
Precision Flexible Cable Assemblies								
PE-VNA-HF Coax, 50 Ohm								
Part No. PE3TC0500	Cable Dia.			Attn. @ 1 GHz	Power @ 1 GHz			
1 piece price shown. See web or call for volume pricing.								
24"	48"	-	-	-	-	Custom Len.		
\$2,789.44	\$2,932.19	-	-	-	-	See Web	17	
2.4MM MALE TO 2.4MM MALE								
Test Flexible Cable Assemblies								
PE-P160 Coax, 50 Ohm								
Part No. PE363	Cable Dia.			Attn. @ 1 GHz	Power @ 1 GHz			
1 piece price shown. See web or call for volume pricing.								
36"	48"	100CM	150CM	-	-	Custom Len.		
\$339.32	\$365.21	\$346.59	\$389.07	-	-	See Web	18	
1.85MM MALE TO 1.85MM MALE								
Standard Flexible Cable Assemblies								
PE-VNA-R Coax, 50 Ohm								
Part No. PE3VNA4004	Cable Dia.			Attn. @ 1 GHz	Power @ 1 GHz			
1 piece price shown. See web or call for volume pricing.								
24"	48"	-	-	-	-	Custom Len.		
\$1,972.35	\$2,175.54	-	-	-	-	See Web	19	
1.85MM MALE TO 1.85MM MALE								
Standard Flexible Cable Assemblies								
PE-P086HF Coax, 50 Ohm								
Part No. PE3C0728	Cable Dia.			Attn. @ 1 GHz	Power @ 1 GHz			
1 piece price shown. See web or call for volume pricing.								
6"	12"	18"	24"	36"	48"	Custom Len.		
\$204.89	\$208.17	\$211.55	\$214.94	\$221.70	\$228.85	See Web	20	
1.85MM MALE TO 1.85MM MALE								
Standard Semi-Rigid Cable Assemblies								
PE-SR405AL Coax, 50 Ohm								
Part No. PE35672	Cable Dia.			Attn. @ 1 GHz	Power @ 1 GHz			
1 piece price shown. See web or call for volume pricing.								
6"	12"	18"	24"	36"	48"	Custom Len.		
\$160.94	\$165.56	\$160.52	\$164.84	\$173.49	\$194.66	See Web	21	

*Coax Performance at 1 GHz Notes: Cable assembly max frequency may be lower than connector or coax max frequency

For our complete selection of cable assemblies, please visit our website

2.4MM MALE TO 2.4MM MALE RIGHT ANGLE							
Precision Flexible Cable Assemblies							
PE-VNA-HF Coax, 50 Ohm							
Part No. PE3TC0700		Cable Dia.	Attn. @ 1 GHz	Power @ 1 GHz			
1 piece price shown. See web or call for volume pricing.		0.270" dia.	dB/100ft	W			
24"	48"	-	-	-	Custom Len.	22	
\$3,262.51	\$3,402.13	-	-	-	See Web		
2.4MM MALE TO 2.4MM FEMALE							
Precision Flexible Cable Assemblies							
PE-VNA-HF Coax, 50 Ohm							
Part No. PE3TC0600		Cable Dia.	Attn. @ 1 GHz	Power @ 1 GHz			
1 piece price shown. See web or call for volume pricing.		0.270" dia.	dB/100ft	W			
24"	48"	-	-	-	Custom Len.	23	
\$2,789.44	\$2,932.19	-	-	-	See Web		
Test Flexible Cable Assemblies							
PE-P160 Coax, 50 Ohm							
Part No. PE364		Cable Dia.	Attn. @ 1 GHz	Power @ 1 GHz			
1 piece price shown. See web or call for volume pricing.		0.160" dia.	13 dB/100ft	W			
36"	48"	100CM	150CM	-	Custom Len.	24	
\$351.30	\$372.12	-	-	-	See Web		
Standard Flexible Cable Assemblies							
PE-VNA-R Coax, 50 Ohm							
Part No. PE3VNA4005		Cable Dia.	Attn. @ 1 GHz	Power @ 1 GHz			
1 piece price shown. See web or call for volume pricing.		0.430" dia.	dB/100ft	W			
24"	48"	-	-	-	Custom Len.	25	
\$2,114.23	\$2,325.34	-	-	-	See Web		
Standard Semi-Rigid Cable Assemblies							
PE-SR405AL Coax, 50 Ohm							
Part No. PE3W00790		Cable Dia.	Attn. @ 1 GHz	Power @ 1 GHz			
1 piece price shown. See web or call for volume pricing.		* dia.	23 dB/100ft	130 W			
6"	12"	18"	24"	36"	48"	26	
\$302.40	\$302.40	\$306.72	\$311.05	\$319.69	\$328.32	See Web	
RG405/U Coax, 50 Ohm							
Part No. PE35654		Cable Dia.	Attn. @ 1 GHz	Power @ 1 GHz			
1 piece price shown. See web or call for volume pricing.		* dia.	22 dB/100ft	130 W			
6"	12"	18"	24"	36"	48"	27	
\$290.57	\$294.17	\$297.88	\$301.59	\$309.02	\$316.88	See Web	
2.4MM MALE TO 2.92MM MALE							
Standard Flexible Cable Assemblies							
PE-P086 Coax, 50 Ohm							
Part No. PE3C0747		Cable Dia.	Attn. @ 1 GHz	Power @ 1 GHz			
1 piece price shown. See web or call for volume pricing.		0.104" dia.	23 dB/100ft	160 W			
12"	24"	36"	48"	60"	72"	28	
\$239.34	\$247.28	\$255.23	\$263.63	\$271.72	\$248.97	See Web	
2.4MM MALE TO SMA MALE							
Standard Semi-Rigid Cable Assemblies							
RG405/U Coax, 50 Ohm							
Part No. PE3C4270		Cable Dia.	Attn. @ 1 GHz	Power @ 1 GHz			
1 piece price shown. See web or call for volume pricing.		* dia.	dB/100ft	130 W			
6"	6"	12"	12"	18"	18"	29	
\$118.46	\$118.46	\$118.46	\$118.46	\$122.07	\$122.07	See Web	
2.4MM MALE TO SMA MALE RIGHT ANGLE							
Standard Formable Cable Assemblies							
PE-SR405FL Coax, 50 Ohm							
Part No. PE3W07990		Cable Dia.	Attn. @ 1 GHz	Power @ 1 GHz			
1 piece price shown. See web or call for volume pricing.		* dia.	23 dB/100ft	105 W			
12"	18"	24"	36"	48"	60"	30	
\$131.90	\$137.52	\$143.14	\$154.38	\$165.62	\$176.86	See Web	
2.4MM FEMALE TO 2.4MM FEMALE							
Precision Flexible Cable Assemblies							
PE-VNA-HF Coax, 50 Ohm							

Part No. PE3TC0650		Cable Dia.	Attn. @ 1 GHz	Power @ 1 GHz			
1 piece price shown. See web or call for volume pricing.		0.270" dia.	dB/100ft	W			
24"	48"	-	-	-	Custom Len.	31	
\$2,945.57	\$3,085.57	-	-	-	See Web		
2.4MM FEMALE BULKHEAD TO SMA MALE							
SEE MOUNTING HOLE SECTION ON PAGE 369							
Standard Formable Cable Assemblies							
PE-SR405FL Coax, 50 Ohm							
Part No. PE3W03550		Cable Dia.	Attn. @ 1 GHz	Power @ 1 GHz			
1 piece price shown. See web or call for volume pricing.		* dia.	23 dB/100ft	105 W			
12"	24"	36"	48"	60"	50CM	32	
\$174.50	\$186.18	\$197.86	\$209.54	\$221.21	\$181.98	See Web	
2.92MM MALE TO 2.4MM MALE							
Standard Formable Cable Assemblies							
PE-SR405FL Coax, 50 Ohm							
Part No. PE3W01131		Cable Dia.	Attn. @ 1 GHz	Power @ 1 GHz			
1 piece price shown. See web or call for volume pricing.		* dia.	23 dB/100ft	130 W			
12"	24"	36"	48"	60"	50CM	33	
\$194.14	\$205.15	\$216.16	\$227.18	\$238.19	\$201.19	See Web	
2.92MM MALE TO 2.92MM MALE							
Flexible Cable Assemblies							
PE-P160 Coax, 50 Ohm							
Part No. PE360		Cable Dia.	Attn. @ 1 GHz	Power @ 1 GHz			
1 piece price shown. See web or call for volume pricing.		* dia.	13 dB/100ft	1070 W			
12"	24"	36"	48"	60"	72"	34	
\$228.92	\$250.52	\$272.13	\$293.74	\$315.34	\$334.78	See Web	
Test Flexible Cable Assemblies							
PE-VNA Coax, 50 Ohm							
Part No. PE319		Cable Dia.	Attn. @ 1 GHz	Power @ 1 GHz			
1 piece price shown. See web or call for volume pricing.		* dia.	dB/100ft	W			
24"	36"	48"	60"	72"	-	35	
\$1,141.68	\$1,359.78	\$1,400.21	\$1,611.55	\$1,893.23	-	See Web	
Standard Formable Cable Assemblies							
PE-SR402FL Coax, 50 Ohm							
Part No. PE34733		Cable Dia.	Attn. @ 1 GHz	Power @ 1 GHz			
1 piece price shown. See web or call for volume pricing.		* dia.	12 dB/100ft	450 W			
6"	12"	18"	24"	36"	48"	36	
\$131.05	\$134.97	\$139.01	\$134.87	\$151.13	\$149.95	See Web	
PE-SR405FL Coax, 50 Ohm							
Part No. PE3C1377		Cable Dia.	Attn. @ 1 GHz	Power @ 1 GHz			
1 piece price shown. See web or call for volume pricing.		* dia.	23 dB/100ft	130 W			
6"	12"	18"	24"	36"	48"	37	
\$167.83	\$167.83	\$173.17	\$178.51	\$189.20	\$199.90	See Web	
Standard Flexible Cable Assemblies							
PE-P086 Coax, 50 Ohm							
Part No. PE3C0666		Cable Dia.	Attn. @ 1 GHz	Power @ 1 GHz			
1 piece price shown. See web or call for volume pricing.		0.104" dia.	23 dB/100ft	160 W			
6"	12"	18"	24"	36"	48"	38	
\$161.97	\$165.82	\$169.79	\$173.76	\$181.70	\$190.11	See Web	
PE-VNA-R Coax, 50 Ohm							
Part No. PE3VNA4001		Cable Dia.	Attn. @ 1 GHz	Power @ 1 GHz			
1 piece price shown. See web or call for volume pricing.		0.430" dia.	dB/100ft	W			
24"	36"	48"	60"	-	-	39	
\$1,925.46	\$2,040.47	\$2,128.65	\$2,243.59	-	-	See Web	
Standard Semi-Rigid Cable Assemblies							
PE-118SR Coax, 50 Ohm							
Part No. PE3W07491		Cable Dia.	Attn. @ 1 GHz	Power @ 1 GHz			
1 piece price shown. See web or call for volume pricing.		* dia.	13 dB/100ft	500 W			
6"	12"	18"	24"	36"	48"	40	
\$286.40	\$286.40	\$288.20	\$290.00	\$293.59	\$297.19	See Web	
PE-SR405FL Coax, 50 Ohm							
Part No. PE34739		Cable Dia.	Attn. @ 1 GHz	Power @ 1 GHz			
1 piece price shown. See web or call for volume pricing.		* dia.	13 dB/100ft	500 W			
6"	12"	18"	24"	36"	48"	41	
\$179.26	\$200.81	\$223.01	\$245.21	\$267.06	\$304.05	See Web	
PE-SR402AL Coax, 50 Ohm							
Part No. PE34731		Cable Dia.	Attn. @ 1 GHz	Power @ 1 GHz			
1 piece price shown. See web or call for volume pricing.		0.141" dia.	13 dB/100ft	450 W			
6"	12"	18"	24"	36"	48"	42	
\$132.10	\$129.28	\$133.99	\$147.22	\$148.11	\$157.52	See Web	
RG402/U Coax, 50 Ohm							

Cable Assemblies

See Our Website For Current Pricing & Real-Time Stock Availability!

Continued on Next Page

For Custom Lengths, Metric Lengths or Special Configurations, Please call (949) 261-1920

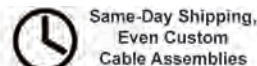
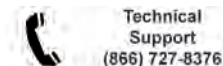

For our complete selection of cable assemblies, please visit our website







Part No. PE34729	Cable Dia.	Attn. @ 1 GHz	Power @ 1 GHz
1 piece price shown. See web or call for volume pricing.	* dia.	12 dB/100ft	650 W
6" 12" 18" 24"	36" 48"	Custom Len.	
\$130.97 \$134.76 \$138.68 \$142.58	\$150.41 \$149.04	See Web	
Skew Matched Pair Flexible Cable Assemblies			
PE-125LLS Coax, 50 Ohm			
Part No. PE3C4680	Cable Dia.	Attn. @ 1 GHz	Power @ 1 GHz
1 piece price shown. See web or call for volume pricing.	0.124" dia.	dB/100ft	W
12" 24" 48"	-	Custom Len.	
\$1,152.59 \$1,277.05 \$1,525.96	-	See Web	
2.92MM MALE TO 2.92MM FEMALE			
Test Flexible Cable Assemblies			
PE-P160 Coax, 50 Ohm			
Part No. PE361	Cable Dia.	Attn. @ 1 GHz	Power @ 1 GHz
1 piece price shown. See web or call for volume pricing.	0.160" dia.	13 dB/100ft	W
36" 48" 100CM 150CM	200CM 12"	Custom Len.	
\$319.65 \$345.54 \$326.92 \$369.41	\$411.87 \$267.86	See Web	
Standard Flexible Cable Assemblies			
PE-VNA-R Coax, 50 Ohm			
Part No. PE3VNA4002	Cable Dia.	Attn. @ 1 GHz	Power @ 1 GHz
1 piece price shown. See web or call for volume pricing.	0.430" dia.	dB/100ft	W
24" 48"	-	Custom Len.	
\$1,987.98 \$2,191.17	-	See Web	
Part No. PE3VNA2606	Cable Dia.	Attn. @ 1 GHz	Power @ 1 GHz
1 piece price shown. See web or call for volume pricing.	0.430" dia.	dB/100ft	W
24" 48"	-	Custom Len.	
\$1,521.23 \$1,714.76	-	See Web	
2.92MM MALE TO 2.92MM FEMALE BULKHEAD			
SEE MOUNTING HOLE SECTION ON PAGE 369			
Standard Formable Cable Assemblies			
PE-SR402FL Coax, 50 Ohm			
Part No. PE34745	Cable Dia.	Attn. @ 1 GHz	Power @ 1 GHz
1 piece price shown. See web or call for volume pricing.	* dia.	12 dB/100ft	450 W
6" 12" 18" 24"	36" 48"	Custom Len.	
\$202.71 \$202.71 \$206.47 \$210.25	\$217.78 \$225.33	See Web	
Standard Semi-Rigid Cable Assemblies			
PE-SR402AL Coax, 50 Ohm			
Part No. PE34743	Cable Dia.	Attn. @ 1 GHz	Power @ 1 GHz
1 piece price shown. See web or call for volume pricing.	0.141" dia.	13 dB/100ft	450 W
6" 12" 18" 24"	36" 48"	Custom Len.	
\$220.13 \$204.61 \$230.16 \$235.25	\$223.44 \$232.85	See Web	
RG402/U Coax, 50 Ohm			
Part No. PE34741	Cable Dia.	Attn. @ 1 GHz	Power @ 1 GHz
1 piece price shown. See web or call for volume pricing.	* dia.	12 dB/100ft	650 W
6" 12" 18" 24"	36" 48"	Custom Len.	
\$210.81 \$214.61 \$218.52 \$209.76	\$217.07 \$224.37	See Web	
3.5MM MALE TO 3.5MM FEMALE			
Test Flexible Cable Assemblies			
PE-P160 Coax, 50 Ohm			
Part No. PE369	Cable Dia.	Attn. @ 1 GHz	Power @ 1 GHz
1 piece price shown. See web or call for volume pricing.	0.160" dia.	13 dB/100ft	W
36" 48" 60" 100CM	150CM	Custom Len.	
\$308.01 \$333.91 \$359.81 \$315.29	\$357.77	See Web	
PE-VNA Coax, 50 Ohm			
Part No. PE315	Cable Dia.	Attn. @ 1 GHz	Power @ 1 GHz
1 piece price shown. See web or call for volume pricing.	* dia.	dB/100ft	W
24" 36" 48" 60"	72"	Custom Len.	
\$942.75 \$1,142.61 \$1,137.86 \$1,334.42	\$1,459.35	See Web	
Standard Flexible Cable Assemblies			
PE-VNA-R Coax, 50 Ohm			
Part No. PE3VNA2603	Cable Dia.	Attn. @ 1 GHz	Power @ 1 GHz
1 piece price shown. See web or call for volume pricing.	0.430" dia.	dB/100ft	W
24" 36" 48" 60"	-	Custom Len.	
\$1,461.69 \$1,710.94 \$1,655.21 \$1,921.98	-	See Web	
Standard Semi-Rigid Cable Assemblies			
PE-SR402AL Coax, 50 Ohm			
Part No. PE34572	Cable Dia.	Attn. @ 1 GHz	Power @ 1 GHz
1 piece price shown. See web or call for volume pricing.	0.141" dia.	13 dB/100ft	450 W
6" 12" 18" 24"	36" 48"	Custom Len.	
\$223.69 \$228.63 \$233.71 \$238.80	\$248.99 \$243.93	See Web	
PE-SR405AL Coax, 50 Ohm			









Part No. PE34576	Cable Dia.	Attn. @ 1 GHz	Power @ 1 GHz
1 piece price shown. See web or call for volume pricing.	* dia.	23 dB/100ft	130 W
6" 12" 18" 24"	36" 48"	Custom Len.	
\$225.05 \$225.05 \$229.36 \$233.68	\$242.34 \$250.97	See Web	
RG402/U Coax, 50 Ohm			
Part No. PE34570	Cable Dia.	Attn. @ 1 GHz	Power @ 1 GHz
1 piece price shown. See web or call for volume pricing.	* dia.	12 dB/100ft	650 W
6" 12" 18" 24"	36" 48"	Custom Len.	
\$213.54 \$213.54 \$217.18 \$220.84	\$228.14 \$235.45	See Web	
RG405/U Coax, 50 Ohm			
Part No. PE34574	Cable Dia.	Attn. @ 1 GHz	Power @ 1 GHz
1 piece price shown. See web or call for volume pricing.	* dia.	22 dB/100ft	130 W
6" 12" 18" 24"	36" 48"	Custom Len.	
\$223.27 \$223.27 \$226.70 \$230.13	\$237.01 \$259.38	See Web	
3.5MM MALE TO 3.5MM FEMALE			
Test Flexible Cable Assemblies			
PE-VNA Coax, 50 Ohm			
Part No. PE317	Cable Dia.	Attn. @ 1 GHz	Power @ 1 GHz
1 piece price shown. See web or call for volume pricing.	* dia.	dB/100ft	W
24" 36" 48" 60"	72"	Custom Len.	
\$1,019.12 \$1,090.09 \$1,310.54 \$1,274.32	\$1,429.02	See Web	
Standard Formable Cable Assemblies			
PE-SR402FL Coax, 50 Ohm			
Part No. PE3W03922	Cable Dia.	Attn. @ 1 GHz	Power @ 1 GHz
1 piece price shown. See web or call for volume pricing.	* dia.	12 dB/100ft	400 W
12" 24" 36" 48"	60" 50CM	Custom Len.	
\$191.04 \$198.89 \$206.73 \$214.57	\$222.42 \$196.07	See Web	
Standard Flexible Cable Assemblies			
PE-FF430 Coax, 50 Ohm			
Part No. PE3C4012	Cable Dia.	Attn. @ 1 GHz	Power @ 1 GHz
1 piece price shown. See web or call for volume pricing.	0.430" dia.	dB/100ft	W
100CM	-	Custom Len.	
\$872.15	-	See Web	
PE-VNA-R Coax, 50 Ohm			
Part No. PE3VNA2604	Cable Dia.	Attn. @ 1 GHz	Power @ 1 GHz
1 piece price shown. See web or call for volume pricing.	0.430" dia.	dB/100ft	W
24" 36" 48" 60"	-	Custom Len.	
\$1,491.45 \$1,743.41 \$1,684.98 \$1,954.45	-	See Web	
Standard Semi-Rigid Cable Assemblies			
PE-SR402AL Coax, 50 Ohm			
Part No. PE34580	Cable Dia.	Attn. @ 1 GHz	Power @ 1 GHz
1 piece price shown. See web or call for volume pricing.	0.141" dia.	13 dB/100ft	450 W
6" 12" 18" 24"	36" 48"	Custom Len.	
\$220.79 \$220.79 \$225.48 \$230.20	\$239.60 \$265.16	See Web	
PE-SR405AL Coax, 50 Ohm			
Part No. PE34584	Cable Dia.	Attn. @ 1 GHz	Power @ 1 GHz
1 piece price shown. See web or call for volume pricing.	* dia.	23 dB/100ft	130 W
12" 24" 36" 48"	60"	Custom Len.	
\$275.72 \$284.08 \$292.47 \$300.83	\$309.23	See Web	
RG402/U Coax, 50 Ohm			
Part No. PE34578	Cable Dia.	Attn. @ 1 GHz	Power @ 1 GHz
1 piece price shown. See web or call for volume pricing.	* dia.	12 dB/100ft	650 W
6" 12" 18" 24"	36" 48"	Custom Len.	
\$227.95 \$218.63 \$222.28 \$225.93	\$233.23 \$240.54	See Web	
RG405/U Coax, 50 Ohm			
Part No. PE34582	Cable Dia.	Attn. @ 1 GHz	Power @ 1 GHz
1 piece price shown. See web or call for volume pricing.	* dia.	22 dB/100ft	130 W
6" 12" 18" 24"	36" 48"	Custom Len.	
\$290.43 \$290.43 \$293.87 \$297.30	\$304.17 \$330.57	See Web	
3.5MM MALE TO 3.5MM FEMALE BULKHEAD			
SEE MOUNTING HOLE SECTION ON PAGE 369			
Standard Semi-Rigid Cable Assemblies			
PE-SR405AL Coax, 50 Ohm			
Part No. PE34592	Cable Dia.	Attn. @ 1 GHz	Power @ 1 GHz
1 piece price shown. See web or call for volume pricing.	* dia.	23 dB/100ft	130 W
6" 12" 18" 24"	36" 48"	Custom Len.	
\$233.54 \$237.69 \$241.89 \$246.09	\$254.44 \$262.84	See Web	
3.5MM FEMALE TO 3.5MM FEMALE			
Standard Flexible Cable Assemblies			
PE-FF430 Coax, 50 Ohm			
Part No. PE3C4013	Cable Dia.	Attn. @ 1 GHz	Power @ 1 GHz
1 piece price shown. See web or call for volume pricing.	0.430" dia.	dB/100ft	W
100CM	-	Custom Len.	
\$872.15	-	See Web	

Cable Assemblies
See Our Website For Current Pricing & Real-Time Stock Availability!

*Coax Performance at 1 GHz Notes: Cable assembly max frequency may be lower than connector or coax max frequency

For our complete selection of cable assemblies, please visit our website

3.5MM FEMALE TO 3.5MM NMD FEMALE							
Standard Flexible Cable Assemblies							
PE-VNA-R Coax, 50 Ohm							
Part No. PE3VNA2610		Cable Dia.	Attn. @ 1 GHz	Power @ 1 GHz			68
1 piece price shown. See web or call for volume pricing.		0.430" dia.	dB/100ft	W			
24"	36"	48"	-	-	Custom Len.		
\$1,730.42	\$1,831.07	\$1,931.73	-	-	-	See Web	
3.5MM NMD FEMALE TO 3.5MM MALE							
Standard Flexible Cable Assemblies							
PE-VNA-R Coax, 50 Ohm							
Part No. PE3VNA2607		Cable Dia.	Attn. @ 1 GHz	Power @ 1 GHz			69
1 piece price shown. See web or call for volume pricing.		0.430" dia.	dB/100ft	W			
24"	36"	48"	-	-	Custom Len.		
\$1,697.95	\$1,798.60	\$1,899.26	-	-	-	See Web	
4.1/9.5 MINI DIN MALE TO 4.1/9.5 MINI DIN MALE							
Corrugated Cable Assemblies							
SPP-250-LLPL Coax, 50 Ohm							
Part No. PE3C4143		Cable Dia.	Attn. @ 1 GHz	Power @ 1 GHz			70
1 piece price shown. See web or call for volume pricing.		0.280" dia.	6 dB/100ft	650 W			
12"	24"	36"	48"	60"	50CM	Custom Len.	
\$92.38	\$97.96	\$103.54	\$109.12	\$114.70	\$95.95	See Web	
Low PIM Formable Cable Assemblies							
PE-SR402FLJ Low PIM Coax, 50 Ohm							
Part No. PE3C2009		Cable Dia.	Attn. @ 1 GHz	Power @ 1 GHz			71
1 piece price shown. See web or call for volume pricing.		0.161" dia.	dB/100ft	W			
100CM	200CM	-	-	-	Custom Len.		
\$103.67	\$124.11	-	-	-	-	See Web	
4.1/9.5 MINI DIN MALE TO 4.1/9.5 MINI DIN MALE RIGHT ANGLE							
Low PIM Corrugated Cable Assemblies							
SPP-250-LLPL Coax, 50 Ohm							
Part No. PE3C5847		Cable Dia.	Attn. @ 1 GHz	Power @ 1 GHz			72
1 piece price shown. See web or call for volume pricing.		0.280" dia.	dB/100ft	W			
12"	24"	36"	48"	60"	50CM	Custom Len.	
\$97.08	\$102.66	\$108.24	\$113.82	\$119.40	\$100.66	See Web	
4.1/9.5 MINI DIN MALE TO 4.1/9.5 MINI DIN FEMALE							
Low PIM Formable Cable Assemblies							
PE-SR402FLJ Low PIM Coax, 50 Ohm							
Part No. PE3C2010		Cable Dia.	Attn. @ 1 GHz	Power @ 1 GHz			73
1 piece price shown. See web or call for volume pricing.		0.161" dia.	dB/100ft	W			
100CM	200CM	-	-	-	Custom Len.		
\$127.25	\$134.05	-	-	-	-	See Web	
Low PIM Corrugated Cable Assemblies							
SPP-250-LLPL Coax, 50 Ohm							
Part No. PE3C5841		Cable Dia.	Attn. @ 1 GHz	Power @ 1 GHz			74
1 piece price shown. See web or call for volume pricing.		0.280" dia.	dB/100ft	W			
12"	24"	36"	48"	60"	50CM	Custom Len.	
\$89.85	\$95.43	\$101.01	\$106.59	\$112.17	\$93.43	See Web	
4.1/9.5 MINI DIN MALE TO 4.3-10 FEMALE							
Low PIM Corrugated Cable Assemblies							
SPP-250-LLPL Coax, 50 Ohm							
Part No. PE3C5834		Cable Dia.	Attn. @ 1 GHz	Power @ 1 GHz			75
1 piece price shown. See web or call for volume pricing.		0.280" dia.	dB/100ft	W			
12"	24"	36"	48"	60"	50CM	Custom Len.	
\$89.85	\$95.43	\$101.01	\$106.59	\$112.17	\$93.43	See Web	
4.1/9.5 MINI DIN MALE TO 7/16 DIN MALE							
Low PIM Corrugated Cable Assemblies							
SPP-250-LLPL Coax, 50 Ohm							

Part No. PE3C4134				Cable Dia.	Attn. @ 1 GHz	Power @ 1 GHz	76
1 piece price shown. See web or call for volume pricing.				0.280" dia.	dB/100ft	W	
12"	24"	36"	48"	60"	50CM	Custom Len.	
\$94.72	\$100.29	\$105.87	\$111.45	\$117.03	\$98.29	See Web	
4.1/9.5 MINI DIN MALE TO 7/16 DIN FEMALE							
Low PIM Corrugated Cable Assemblies							
SPP-250-LLPL Coax, 50 Ohm							
Part No. PE3C5854		Cable Dia.	Attn. @ 1 GHz	Power @ 1 GHz			77
1 piece price shown. See web or call for volume pricing.		0.280" dia.	dB/100ft	W			
12"	24"	36"	48"	60"	50CM	Custom Len.	
\$89.85	\$95.43	\$101.01	\$106.59	\$112.17	\$93.43	See Web	
4.1/9.5 MINI DIN MALE TO QMA MALE							
Low PIM Corrugated Cable Assemblies							
SPP-250-LLPL Coax, 50 Ohm							
Part No. PE3C5866		Cable Dia.	Attn. @ 1 GHz	Power @ 1 GHz			78
1 piece price shown. See web or call for volume pricing.		0.280" dia.	dB/100ft	W			
12"	24"	36"	48"	60"	50CM	Custom Len.	
\$79.03	\$84.61	\$90.19	\$95.76	\$101.34	\$82.60	See Web	
4.1/9.5 MINI DIN MALE TO QMA MALE RIGHT ANGLE							
Low PIM Corrugated Cable Assemblies							
SPP-250-LLPL Coax, 50 Ohm							
Part No. PE3C5872		Cable Dia.	Attn. @ 1 GHz	Power @ 1 GHz			79
1 piece price shown. See web or call for volume pricing.		0.280" dia.	dB/100ft	W			
12"	24"	36"	48"	60"	50CM	Custom Len.	
\$81.20	\$86.78	\$92.36	\$97.94	\$103.52	\$84.77	See Web	
4.1/9.5 MINI DIN MALE TO QMA FEMALE							
Low PIM Corrugated Cable Assemblies							
SPP-250-LLPL Coax, 50 Ohm							
Part No. PE3C5860		Cable Dia.	Attn. @ 1 GHz	Power @ 1 GHz			80
1 piece price shown. See web or call for volume pricing.		0.280" dia.	dB/100ft	W			
12"	24"	36"	48"	60"	50CM	Custom Len.	
\$75.43	\$81.01	\$86.59	\$92.17	\$97.75	\$79.01	See Web	
4.1/9.5 MINI DIN MALE TO SMA MALE							
Low PIM Corrugated Cable Assemblies							
SPP-250-LLPL Coax, 50 Ohm							
Part No. PE3C5885		Cable Dia.	Attn. @ 1 GHz	Power @ 1 GHz			81
1 piece price shown. See web or call for volume pricing.		0.280" dia.	dB/100ft	W			
12"	24"	36"	48"	60"	50CM	Custom Len.	
\$71.81	\$77.38	\$82.96	\$88.54	\$94.12	\$75.38	See Web	
4.1/9.5 MINI DIN MALE TO SMA MALE RIGHT ANGLE							
Low PIM Corrugated Cable Assemblies							
SPP-250-LLPL Coax, 50 Ohm							
Part No. PE3C5890		Cable Dia.	Attn. @ 1 GHz	Power @ 1 GHz			82
1 piece price shown. See web or call for volume pricing.		0.280" dia.	dB/100ft	W			
12"	24"	36"	48"	60"	50CM	Custom Len.	
\$73.26	\$78.84	\$84.42	\$90.00	\$95.58	\$76.83	See Web	
4.1/9.5 MINI DIN MALE TO SMA FEMALE							
Low PIM Corrugated Cable Assemblies							
SPP-250-LLPL Coax, 50 Ohm							
Part No. PE3C5879		Cable Dia.	Attn. @ 1 GHz	Power @ 1 GHz			83
1 piece price shown. See web or call for volume pricing.		0.280" dia.	dB/100ft	W			
12"	24"	36"	48"	60"	50CM	Custom Len.	
\$72.53	\$78.11	\$83.69	\$89.27	\$94.85	\$76.11	See Web	
4.1/9.5 MINI DIN MALE RIGHT ANGLE TO 4.1/9.5 MINI DIN MALE RIGHT ANGLE							
Low PIM Corrugated Cable Assemblies							

Cable Assemblies

See Our Website For Current Pricing & Real-Time Stock Availability!

Continued on Next Page

For Custom Lengths, Metric Lengths or Special Configurations, Please call (949) 261-1920

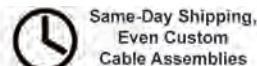
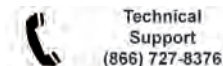

For our complete selection of cable assemblies, please visit our website

Cable Assemblies

See Our Website For Current Pricing & Real-Time Stock Availability!

SPP-250-LLPL Coax, 50 Ohm						
Part No. PE3C5852	Cable Dia.			Attn. @ 1 GHz	Power @ 1 GHz	84
1 piece price shown. See web or call for volume pricing.						
12"	24"	36"	48"	60"	50CM	Custom Len.
\$107.91	\$113.49	\$119.07	\$124.65	\$130.23	\$111.48	See Web

4. 1/9.5 MINI DIN MALE RIGHT ANGLE TO 4.3-10 MALE 

Low PIM Corrugated Cable Assemblies

SPP-250-LLPL Coax, 50 Ohm						
Part No. PE3C5846	Cable Dia.			Attn. @ 1 GHz	Power @ 1 GHz	85
1 piece price shown. See web or call for volume pricing.						
12"	24"	36"	48"	60"	50CM	Custom Len.
\$97.08	\$102.66	\$108.24	\$113.82	\$119.40	\$100.66	See Web

4. 1/9.5 MINI DIN MALE RIGHT ANGLE TO 4.3-10 FEMALE 

Corrugated Cable Assemblies

SPP-250-LLPL Coax, 50 Ohm						
Part No. PE3C5950	Cable Dia.			Attn. @ 1 GHz	Power @ 1 GHz	86
1 piece price shown. See web or call for volume pricing.						
12"	24"	36"	48"	60"	50CM	Custom Len.
\$100.68	\$106.26	\$111.84	\$117.42	\$123.00	\$104.24	See Web

4. 1/9.5 MINI DIN MALE RIGHT ANGLE TO 7/16 DIN MALE 

Low PIM Corrugated Cable Assemblies

SPP-250-LLPL Coax, 50 Ohm						
Part No. PE3C5848	Cable Dia.			Attn. @ 1 GHz	Power @ 1 GHz	87
1 piece price shown. See web or call for volume pricing.						
12"	24"	36"	48"	60"	50CM	Custom Len.
\$100.68	\$106.26	\$111.84	\$117.42	\$123.00	\$104.25	See Web

4. 1/9.5 MINI DIN MALE RIGHT ANGLE TO N MALE 

Low PIM Corrugated Cable Assemblies

SPP-250-LLPL Coax, 50 Ohm						
Part No. PE3C5849	Cable Dia.			Attn. @ 1 GHz	Power @ 1 GHz	88
1 piece price shown. See web or call for volume pricing.						
12"	24"	36"	48"	60"	50CM	Custom Len.
\$93.46	\$99.04	\$104.62	\$110.20	\$115.78	\$97.03	See Web

4. 1/9.5 MINI DIN MALE RIGHT ANGLE TO QMA MALE 

Low PIM Corrugated Cable Assemblies

SPP-250-LLPL Coax, 50 Ohm						
Part No. PE3C5850	Cable Dia.			Attn. @ 1 GHz	Power @ 1 GHz	89
1 piece price shown. See web or call for volume pricing.						
12"	24"	36"	48"	60"	50CM	Custom Len.
\$89.85	\$95.43	\$101.01	\$106.59	\$112.17	\$93.43	See Web

4. 1/9.5 MINI DIN MALE RIGHT ANGLE TO SMA MALE 

Low PIM Corrugated Cable Assemblies

SPP-250-LLPL Coax, 50 Ohm						
Part No. PE3C5851	Cable Dia.			Attn. @ 1 GHz	Power @ 1 GHz	90
1 piece price shown. See web or call for volume pricing.						
12"	24"	36"	48"	60"	50CM	Custom Len.
\$82.63	\$88.21	\$93.79	\$99.37	\$104.95	\$86.21	See Web

4. 1/9.5 MINI DIN FEMALE TO 4.3-10 MALE 

Low PIM Corrugated Cable Assemblies

SPP-250-LLPL Coax, 50 Ohm						
Part No. PE3C5840	Cable Dia.			Attn. @ 1 GHz	Power @ 1 GHz	91
1 piece price shown. See web or call for volume pricing.						
12"	24"	36"	48"	60"	50CM	Custom Len.
\$89.85	\$95.43	\$101.01	\$106.59	\$112.17	\$93.43	See Web

4. 1/9.5 MINI DIN FEMALE TO 7/16 DIN MALE 

Low PIM Corrugated Cable Assemblies

SPP-250-LLPL Coax, 50 Ohm						
Part No. PE3C5842	Cable Dia.			Attn. @ 1 GHz	Power @ 1 GHz	92
1 piece price shown. See web or call for volume pricing.						
12"	24"	36"	48"	60"	50CM	Custom Len.
\$93.45	\$99.03	\$104.61	\$110.19	\$115.77	\$97.02	See Web

4. 1/9.5 MINI DIN FEMALE TO N MALE 

Low PIM Corrugated Cable Assemblies

SPP-250-LLPL Coax, 50 Ohm						
Part No. PE3C5843	Cable Dia.			Attn. @ 1 GHz	Power @ 1 GHz	93
1 piece price shown. See web or call for volume pricing.						
12"	24"	36"	48"	60"	50CM	Custom Len.
\$86.23	\$91.81	\$97.39	\$102.96	\$108.54	\$89.80	See Web

4. 1/9.5 MINI DIN FEMALE TO QMA MALE 

Low PIM Corrugated Cable Assemblies

SPP-250-LLPL Coax, 50 Ohm						
Part No. PE3C5844	Cable Dia.			Attn. @ 1 GHz	Power @ 1 GHz	94
1 piece price shown. See web or call for volume pricing.						
12"	24"	36"	48"	60"	50CM	Custom Len.
\$82.62	\$88.20	\$93.78	\$99.36	\$104.94	\$86.20	See Web

4. 1/9.5 MINI DIN FEMALE TO SMA MALE 

Low PIM Corrugated Cable Assemblies

SPP-250-LLPL Coax, 50 Ohm						
Part No. PE3C5845	Cable Dia.			Attn. @ 1 GHz	Power @ 1 GHz	95
1 piece price shown. See web or call for volume pricing.						
12"	24"	36"	48"	60"	50CM	Custom Len.
\$75.40	\$80.98	\$86.56	\$92.14	\$97.72	\$78.97	See Web

4.3-10 MALE TO 4.3-10 MALE 

Low PIM Corrugated Cable Assemblies

SPP-250-LLPL Coax, 50 Ohm						
Part No. PE3C4142	Cable Dia.			Attn. @ 1 GHz	Power @ 1 GHz	96
1 piece price shown. See web or call for volume pricing.						
12"	24"	36"	48"	60"	50CM	Custom Len.
\$92.38	\$97.96	\$103.54	\$109.12	\$114.70	\$95.95	See Web

4.3-10 MALE TO 4.3-10 FEMALE 

Low PIM Corrugated Cable Assemblies

SPP-250-LLPL Coax, 50 Ohm						
Part No. PE3C5833	Cable Dia.			Attn. @ 1 GHz	Power @ 1 GHz	97
1 piece price shown. See web or call for volume pricing.						
12"	24"	36"	48"	60"	50CM	Custom Len.
\$89.85	\$95.43	\$101.01	\$106.59	\$112.17	\$93.43	See Web

4.3-10 MALE TO 7/16 DIN MALE 

Low PIM Corrugated Cable Assemblies

SPP-250-LLPL Coax, 50 Ohm						
Part No. PE3C4135	Cable Dia.			Attn. @ 1 GHz	Power @ 1 GHz	98
1 piece price shown. See web or call for volume pricing.						
12"	24"	36"	48"	60"	6 dB/100ft	650 W
\$94.72	\$100.29	\$105.87	\$111.45	\$117.03	\$98.29	See Web

4.3-10 MALE TO 7/16 DIN FEMALE 

Low PIM Corrugated Cable Assemblies

SPP-250-LLPL Coax, 50 Ohm						
Part No. PE3C5853	Cable Dia.			Attn. @ 1 GHz	Power @ 1 GHz	99
1 piece price shown. See web or call for volume pricing.						
12"	24"	36"	48"	60"	50CM	Custom Len.
\$89.85	\$95.43	\$101.01	\$106.59	\$112.17	\$93.43	See Web

4.3-10 MALE TO N MALE 

Corrugated Cable Assemblies

*Coax Performance at 1 GHz Notes: Cable assembly max frequency may be lower than connector or coax max frequency

For our complete selection of cable assemblies, please visit our website

SPP-250-LLPL Coax, 50 Ohm					Cable Dia.	Attn. @ 1 GHz	Power @ 1 GHz
Part No. PE3C4141					0.280" dia.	6 dB/100ft	650 W
1 piece price shown. See web or call for volume pricing.							
12"	24"	36"	48"	60"	50CM	Custom Len.	
\$90.05	\$95.63	\$101.21	\$106.79	\$112.37	\$93.62	See Web	

4.3-10 MALE TO QMA MALE



Corrugated Cable Assemblies

SPP-250-LLPL Coax, 50 Ohm					Cable Dia.	Attn. @ 1 GHz	Power @ 1 GHz
Part No. PE3C5865					0.280" dia.	6 dB/100ft	650 W
1 piece price shown. See web or call for volume pricing.							
12"	24"	36"	48"	60"	50CM	Custom Len.	
\$79.03	\$84.61	\$90.19	\$95.76	\$101.34	\$82.60	See Web	

4.3-10 MALE TO QMA MALE
RIGHT ANGLE



Corrugated Cable Assemblies

SPP-250-LLPL Coax, 50 Ohm					Cable Dia.	Attn. @ 1 GHz	Power @ 1 GHz
Part No. PE3C5871					0.280" dia.	6 dB/100ft	650 W
1 piece price shown. See web or call for volume pricing.							
12"	24"	36"	48"	60"	50CM	Custom Len.	
\$81.20	\$86.78	\$92.36	\$97.94	\$103.52	\$84.77	See Web	

4.3-10 MALE TO QMA FEMALE



Low PIM Corrugated Cable Assemblies

SPP-250-LLPL Coax, 50 Ohm					Cable Dia.	Attn. @ 1 GHz	Power @ 1 GHz
Part No. PE3C5859					0.280" dia.	dB/100ft	W
1 piece price shown. See web or call for volume pricing.							
12"	24"	36"	48"	60"	50CM	Custom Len.	
\$75.43	\$81.01	\$86.59	\$92.17	\$97.75	\$79.01	See Web	

4.3-10 MALE TO SMA MALE



Low PIM Corrugated Cable Assemblies

SPP-250-LLPL Coax, 50 Ohm					Cable Dia.	Attn. @ 1 GHz	Power @ 1 GHz
Part No. PE3C5884					0.280" dia.	dB/100ft	W
1 piece price shown. See web or call for volume pricing.							
12"	24"	36"	48"	60"	50CM	Custom Len.	
\$71.81	\$77.38	\$82.96	\$88.54	\$94.12	\$75.38	See Web	

4.3-10 MALE TO SMA MALE RIGHT ANGLE



Corrugated Cable Assemblies

SPP-250-LLPL Coax, 50 Ohm					Cable Dia.	Attn. @ 1 GHz	Power @ 1 GHz
Part No. PE3C5889					0.280" dia.	6 dB/100ft	650 W
1 piece price shown. See web or call for volume pricing.							
12"	24"	36"	48"	60"	50CM	Custom Len.	
\$73.26	\$78.84	\$84.42	\$90.00	\$95.58	\$76.83	See Web	

4.3-10 MALE TO SMA FEMALE



Corrugated Cable Assemblies

SPP-250-LLPL Coax, 50 Ohm					Cable Dia.	Attn. @ 1 GHz	Power @ 1 GHz
Part No. PE3C5878					0.280" dia.	6 dB/100ft	650 W
1 piece price shown. See web or call for volume pricing.							
12"	24"	36"	48"	60"	50CM	Custom Len.	
\$72.53	\$78.11	\$83.69	\$89.27	\$94.85	\$76.11	See Web	

4.3-10 MALE RIGHT ANGLE TO 4.3-10 MALE



Low PIM Corrugated Cable Assemblies

SPP-250-LLPL Coax, 50 Ohm					Cable Dia.	Attn. @ 1 GHz	Power @ 1 GHz
Part No. PE3C4147					0.280" dia.	dB/100ft	W
1 piece price shown. See web or call for volume pricing.							
12"	24"	36"	48"	60"	50CM	Custom Len.	
\$99.40	\$104.98	\$110.56	\$116.14	\$121.72	\$102.98	See Web	

4.3-10 MALE RIGHT ANGLE TO
4.3-10 MALE RIGHT ANGLE



Low PIM Corrugated Cable Assemblies

SPP-250-LLPL Coax, 50 Ohm					Cable Dia.	Attn. @ 1 GHz	Power @ 1 GHz
Part No. PE3C4146					0.280" dia.	dB/100ft	W
1 piece price shown. See web or call for volume pricing.							
12"	24"	36"	48"	60"	50CM	Custom Len.	
\$106.41	\$111.99	\$117.57	\$123.15	\$128.73	\$109.99	See Web	

4.3-10 FEMALE TO N MALE



Low PIM Corrugated Cable Assemblies

SPP-250-LLPL Coax, 50 Ohm					Cable Dia.	Attn. @ 1 GHz	Power @ 1 GHz
Part No. PE3C5837					0.280" dia.	dB/100ft	W
1 piece price shown. See web or call for volume pricing.							
12"	24"	36"	48"	60"	50CM	Custom Len.	
\$86.23	\$91.81	\$97.39	\$102.96	\$108.54	\$89.80	See Web	

4.3-10 FEMALE TO QMA MALE



Corrugated Cable Assemblies

SPP-250-LLPL Coax, 50 Ohm					Cable Dia.	Attn. @ 1 GHz	Power @ 1 GHz
Part No. PE3C5838					0.280" dia.	6 dB/100ft	650 W
1 piece price shown. See web or call for volume pricing.							
12"	24"	36"	48"	60"	50CM	Custom Len.	
\$82.62	\$88.20	\$93.78	\$99.36	\$104.94	\$86.20	See Web	

4.3-10 FEMALE TO SMA MALE



Low PIM Corrugated Cable Assemblies

SPP-250-LLPL Coax, 50 Ohm					Cable Dia.	Attn. @ 1 GHz	Power @ 1 GHz
Part No. PE3C5839					0.280" dia.	dB/100ft	W
1 piece price shown. See web or call for volume pricing.							
12"	24"	36"	48"	60"	50CM	Custom Len.	
\$75.40	\$80.98	\$86.56	\$92.14	\$97.72	\$78.97	See Web	

7/16 DIN MALE TO 4.3-10 FEMALE



Corrugated Cable Assemblies

SPP-250-LLPL Coax, 50 Ohm					Cable Dia.	Attn. @ 1 GHz	Power @ 1 GHz
Part No. PE3C5836					0.280" dia.	6 dB/100ft	650 W
1 piece price shown. See web or call for volume pricing.							
12"	24"	36"	48"	60"	50CM	Custom Len.	
\$93.45	\$99.03	\$104.61	\$110.19	\$115.77	\$97.02	See Web	

7/16 DIN MALE TO 7/16 DIN MALE



Low Loss Formable Cable Assemblies

LMR-SW396 Coax, 50 Ohm					Cable Dia.	Attn. @ 1 GHz	Power @ 1 GHz
Part No. PE3C0138					0.450" dia.	3 dB/100ft	W
1 piece price shown. See web or call for volume pricing.							
12"	24"	36"	48"	60"	-	Custom Len.	
\$79.18	\$81.47	\$83.74	\$86.02	\$88.32	-	See Web	

LMR-SW540 Coax, 50 Ohm					Cable Dia.	Attn. @ 1 GHz	Power @ 1 GHz
Part No. PE3C0141					" dia.	2 dB/100ft	W
1 piece price shown. See web or call for volume pricing.							
12"	24"	36"	48"	60"	-	Custom Len.	
\$84.20	\$86.81	\$94.48	\$92.02	\$99.90	-	See Web	

Low Loss Flexible Cable Assemblies

PE-C195 Coax, 50 Ohm					Cable Dia.	Attn. @ 1 GHz	Power @ 1 GHz
Part No. PE37952					0.195" dia.	11 dB/100ft	150 W
1 piece price shown. See web or call for volume pricing.							
36"	48"	60"	72"	120"	-	Custom Len.	
\$84.76	\$85.49	\$86.15	\$86.81	\$89.57	-	See Web	

PE-C600 Coax, 50 Ohm					Cable Dia.	Attn. @ 1 GHz	Power @ 1 GHz
Part No. PE37955					0.590" dia.	3 dB/100ft	900 W
1 piece price shown. See web or call for volume pricing.							
36"	48"	60"	72"	120"	-	Custom Len.	
\$169.97	\$162.83	\$165.32	\$167.78	\$177.69	-	See Web	

LMR-400 Coax, 50 Ohm					Cable Dia.	Attn. @ 1 GHz	Power @ 1 GHz
Part No. PE3W03530					0.405" dia.	4 dB/100ft	W
1 piece price shown. See web or call for volume pricing.							
12"	24"	36"	48"	60"	50CM	Custom Len.	
\$87.64	\$88.89	\$90.13	\$91.38	\$92.63	\$88.44	See Web	

Low PIM Formable Cable Assemblies

PE-SR401FLJ Low PIM Coax, 50 Ohm

Cable Assemblies

See Our Website For Current Pricing & Real-Time Stock Availability!

Continued on Next Page

For Custom Lengths, Metric Lengths or Special Configurations, Please call (949) 261-1920

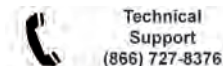

Technical Support
(866) 727-8376



Same-Day Shipping,
Even Custom
Cable Assemblies

For our complete selection of cable assemblies, please visit our website

Part No. PE3C2013					Cable Dia.	Attn. @ 1 GHz	Power @ 1 GHz
1 piece price shown. See web or call for volume pricing.					0.276" dia.	dB/100ft	W
100CM	200CM	-	-	-	-	-	Custom Len.
\$176.10	\$204.49	-	-	-	-	-	See Web
PE-SR402FLJ Low PIM Coax, 50 Ohm							
Part No. PE3C2003					Cable Dia.	Attn. @ 1 GHz	Power @ 1 GHz
1 piece price shown. See web or call for volume pricing.					0.161" dia.	dB/100ft	W
100CM	200CM	-	-	-	-	-	Custom Len.
\$128.29	\$148.72	-	-	-	-	-	See Web
Low PIM Corrugated Cable Assemblies							
SPP-250-LLPL Coax, 50 Ohm							
Part No. PE3C4130					Cable Dia.	Attn. @ 1 GHz	Power @ 1 GHz
1 piece price shown. See web or call for volume pricing.					0.280" dia.	6 dB/100ft	650 W
12"	24"	36"	48"	60"	50CM	-	Custom Len.
\$97.05	\$102.63	\$108.21	\$113.79	\$119.37	\$100.35	-	See Web
Standard Formable Cable Assemblies							
PE-SR401FL Coax, 50 Ohm							
Part No. PE36140					Cable Dia.	Attn. @ 1 GHz	Power @ 1 GHz
1 piece price shown. See web or call for volume pricing.					" dia.	8 dB/100ft	1400 W
12"	24"	36"	48"	60"	72"	-	Custom Len.
\$309.11	\$324.05	\$339.00	\$353.95	\$368.87	\$383.82	-	See Web
Standard Flexible Cable Assemblies							
RG58C/U Coax, 50 Ohm							
Part No. PE3183					Cable Dia.	Attn. @ 1 GHz	Power @ 1 GHz
1 piece price shown. See web or call for volume pricing.					0.195" dia.	20 dB/100ft	44 W
12"	24"	36"	48"	60"	72"	-	Custom Len.
\$238.15	\$238.89	\$239.62	\$240.35	\$241.09	\$241.83	-	See Web
RG142B/U Coax, 50 Ohm							
Part No. PE3189					Cable Dia.	Attn. @ 1 GHz	Power @ 1 GHz
1 piece price shown. See web or call for volume pricing.					0.195" dia.	13 dB/100ft	W
12"	24"	36"	48"	60"	72"	-	Custom Len.
\$105.52	\$111.26	\$116.98	\$122.72	\$128.45	\$134.18	-	See Web
RG214/U Coax, 50 Ohm							
Part No. PE3185					Cable Dia.	Attn. @ 1 GHz	Power @ 1 GHz
1 piece price shown. See web or call for volume pricing.					0.425" dia.	7 dB/100ft	170 W
12"	24"	36"	48"	60"	72"	-	Custom Len.
\$263.79	\$271.11	\$278.44	\$303.41	\$293.08	\$300.42	-	See Web
RG217/U Coax, 50 Ohm							
Part No. PE36134					Cable Dia.	Attn. @ 1 GHz	Power @ 1 GHz
1 piece price shown. See web or call for volume pricing.					0.545" dia.	6 dB/100ft	260 W
12"	24"	36"	48"	60"	72"	-	Custom Len.
\$319.51	\$323.92	\$328.32	\$332.73	\$337.12	\$341.53	-	See Web
RG218/U Coax, 50 Ohm							
Part No. PE35900					Cable Dia.	Attn. @ 1 GHz	Power @ 1 GHz
1 piece price shown. See web or call for volume pricing.					0.870" dia.	4 dB/100ft	560 W
12"	24"	36"	48"	60"	72"	-	Custom Len.
\$348.27	\$359.76	\$371.27	\$382.76	\$418.87	\$405.76	-	See Web
RG393/U Coax, 50 Ohm							
Part No. PE3205					Cable Dia.	Attn. @ 1 GHz	Power @ 1 GHz
1 piece price shown. See web or call for volume pricing.					0.390" dia.	8 dB/100ft	1700 W
12"	24"	36"	48"	60"	72"	-	Custom Len.
\$272.51	\$163.49	\$179.89	\$197.25	\$213.98	\$230.71	-	See Web
RG400/U Coax, 50 Ohm							
Part No. PE34360					Cable Dia.	Attn. @ 1 GHz	Power @ 1 GHz
1 piece price shown. See web or call for volume pricing.					0.195" dia.	15 dB/100ft	650 W
12"	24"	36"	48"	60"	72"	-	Custom Len.
\$107.05	\$114.05	\$121.06	\$128.10	\$135.12	\$142.14	-	See Web
7/16 DIN MALE TO 7/16 DIN MALE RIGHT ANGLE							
Low Loss Flexible Cable Assemblies							
PE-C600 Coax, 50 Ohm							
Part No. PE37959					Cable Dia.	Attn. @ 1 GHz	Power @ 1 GHz
1 piece price shown. See web or call for volume pricing.					0.590" dia.	3 dB/100ft	900 W
36"	48"	60"	72"	120"	-	-	Custom Len.
\$186.83	\$178.74	\$181.21	\$183.68	\$193.60	-	-	See Web
Standard Flexible Cable Assemblies							
RG214/U Coax, 50 Ohm							
Part No. PE38584					Cable Dia.	Attn. @ 1 GHz	Power @ 1 GHz
1 piece price shown. See web or call for volume pricing.					0.425" dia.	7 dB/100ft	190 W
12"	24"	36"	48"	60"	-	-	Custom Len.
\$285.67	\$293.00	\$300.32	\$307.65	\$314.97	-	-	See Web
RG217/U Coax, 50 Ohm							
Part No. PE37600					Cable Dia.	Attn. @ 1 GHz	Power @ 1 GHz
1 piece price shown. See web or call for volume pricing.					0.545" dia.	6 dB/100ft	260 W
12"	24"	36"	48"	60"	-	-	Custom Len.
\$357.82	\$362.23	\$366.63	\$371.04	\$398.54	-	-	See Web
RG393/U Coax, 50 Ohm							
Part No. PE36657					Cable Dia.	Attn. @ 1 GHz	Power @ 1 GHz
1 piece price shown. See web or call for volume pricing.					0.390" dia.	9 dB/100ft	1700 W
12"	24"	36"	48"	60"	-	-	Custom Len.
\$311.31	\$327.71	\$324.61	\$340.09	\$378.21	-	-	See Web

7/16 DIN MALE TO 7/16 DIN FEMALE							
Low PIM Formable Cable Assemblies							
PE-SR401FLJ Low PIM Coax, 50 Ohm							
Part No. PE3C2015					Cable Dia.	Attn. @ 1 GHz	Power @ 1 GHz
1 piece price shown. See web or call for volume pricing.					0.276" dia.	dB/100ft	W
100CM	200CM	-	-	-	-	-	Custom Len.
\$176.10	\$204.49	-	-	-	-	-	See Web
PE-SR402FLJ Low PIM Coax, 50 Ohm							
Part No. PE3C2004					Cable Dia.	Attn. @ 1 GHz	Power @ 1 GHz
1 piece price shown. See web or call for volume pricing.					0.161" dia.	dB/100ft	W
100CM	200CM	-	-	-	-	-	Custom Len.
\$113.44	\$121.71	-	-	-	-	-	See Web
Low PIM Corrugated Cable Assemblies							
SPP-250-LLPL Coax, 50 Ohm							
Part No. PE3C5855					Cable Dia.	Attn. @ 1 GHz	Power @ 1 GHz
1 piece price shown. See web or call for volume pricing.					0.280" dia.	dB/100ft	W
12"	24"	36"	48"	60"	50CM	-	Custom Len.
\$93.45	\$99.03	\$104.61	\$110.19	\$115.77	\$97.02	-	See Web
Standard Flexible Cable Assemblies							
RG393/U Coax, 50 Ohm							
Part No. PE37450					Cable Dia.	Attn. @ 1 GHz	Power @ 1 GHz
1 piece price shown. See web or call for volume pricing.					0.390" dia.	9 dB/100ft	1700 W
12"	24"	36"	48"	60"	-	-	Custom Len.
\$282.36	\$297.82	\$313.29	\$328.76	\$366.20	-	-	See Web
7/16 DIN MALE TO N MALE							
Low Loss Flexible Cable Assemblies							
LMR-400-UF Coax, 50 Ohm							
Part No. PE3W03271					Cable Dia.	Attn. @ 1 GHz	Power @ 1 GHz
1 piece price shown. See web or call for volume pricing.					0.405" dia.	5 dB/100ft	W
12"	24"	36"	48"	60"	50CM	-	Custom Len.
\$92.63	\$95.25	\$97.87	\$100.50	\$103.13	\$94.31	-	See Web
Standard Semi-Rigid Cable Assemblies							
RG401/U Coax, 50 Ohm							
Part No. PE36174					Cable Dia.	Attn. @ 1 GHz	Power @ 1 GHz
1 piece price shown. See web or call for volume pricing.					" dia.	8 dB/100ft	1400 W
12"	24"	36"	48"	60"	-	-	Custom Len.
\$220.58	\$241.89	\$263.20	\$284.45	\$305.76	-	-	See Web
7/16 DIN MALE TO QMA MALE							
Low PIM Corrugated Cable Assemblies							
SPP-250-LLPL Coax, 50 Ohm							
Part No. PE3C5867					Cable Dia.	Attn. @ 1 GHz	Power @ 1 GHz
1 piece price shown. See web or call for volume pricing.					0.280" dia.	dB/100ft	W
12"	24"	36"	48"	60"	50CM	-	Custom Len.
\$82.62	\$88.20	\$93.78	\$99.36	\$104.94	\$86.20	-	See Web
7/16 DIN MALE TO QMA MALE RIGHT ANGLE							
Low PIM Corrugated Cable Assemblies							
SPP-250-LLPL Coax, 50 Ohm							
Part No. PE3C5873					Cable Dia.	Attn. @ 1 GHz	Power @ 1 GHz
1 piece price shown. See web or call for volume pricing.					0.280" dia.	dB/100ft	W
12"	24"	36"	48"	60"	50CM	-	Custom Len.
\$84.79	\$90.37	\$95.95	\$101.53	\$107.11	\$88.37	-	See Web
7/16 DIN MALE TO QMA FEMALE							
Low PIM Corrugated Cable Assemblies							
SPP-250-LLPL Coax, 50 Ohm							
Part No. PE3C5861					Cable Dia.	Attn. @ 1 GHz	Power @ 1 GHz
1 piece price shown. See web or call for volume pricing.					0.280" dia.	dB/100ft	W
12"	24"	36"	48"	60"	50CM	-	Custom Len.
\$79.03	\$84.61	\$90.19	\$95.76	\$101.34	\$82.60	-	See Web
7/16 DIN MALE TO SC MALE							
Standard Flexible Cable Assemblies							
RG393/U Coax, 50 Ohm							

Cable Assemblies

See Our Website For Current Pricing & Real-Time Stock Availability!

*Coax Performance at 1 GHz Notes: Cable assembly max frequency may be lower than connector or coax max frequency

For our complete selection of cable assemblies, please visit our website

Part No. PE37497	Cable Dia.	Attn. @ 1 GHz	Power @ 1 GHz
1 piece price shown. See web or call for volume pricing.	0.390" dia.	9 dB/100ft	1700 W
12" 24" 36" 48"	60"	50CM	Custom Len.
\$207.17 \$223.09 \$239.02 \$254.95	\$270.88	\$217.37	See Web

7/16 DIN MALE TO SMA MALE



Corrugated Cable Assemblies

SPP-250-LLPL Coax, 50 Ohm

Part No. PE3C5886	Cable Dia.	Attn. @ 1 GHz	Power @ 1 GHz
1 piece price shown. See web or call for volume pricing.	0.280" dia.	6 dB/100ft	650 W
12" 24" 36" 48"	60"	50CM	Custom Len.
\$75.40 \$80.98 \$86.56 \$92.14	\$97.72	\$78.97	See Web

7/16 DIN MALE TO SMA MALE
RIGHT ANGLE



Low PIM Corrugated Cable Assemblies

SPP-250-LLPL Coax, 50 Ohm

Part No. PE3C5891	Cable Dia.	Attn. @ 1 GHz	Power @ 1 GHz
1 piece price shown. See web or call for volume pricing.	0.280" dia.	dB/100ft	W
12" 24" 36" 48"	60"	50CM	Custom Len.
\$76.85 \$82.43 \$88.01 \$93.59	\$99.17	\$80.43	See Web

7/16 DIN MALE TO SMA FEMALE



Low PIM Corrugated Cable Assemblies

SPP-250-LLPL Coax, 50 Ohm

Part No. PE3C5880	Cable Dia.	Attn. @ 1 GHz	Power @ 1 GHz
1 piece price shown. See web or call for volume pricing.	0.280" dia.	dB/100ft	W
12" 24" 36" 48"	60"	50CM	Custom Len.
\$76.13 \$81.71 \$87.29 \$92.87	\$98.45	\$79.70	See Web

7/16 DIN MALE RIGHT ANGLE TO 7/16 DIN
MALE



Low PIM Corrugated Cable Assemblies

SPP-250-LLPL Coax, 50 Ohm

Part No. PE3C4131	Cable Dia.	Attn. @ 1 GHz	Power @ 1 GHz
1 piece price shown. See web or call for volume pricing.	0.280" dia.	dB/100ft	W
12" 24" 36" 48"	60"	50CM	Custom Len.
\$108.75 \$114.34 \$119.92 \$125.50	\$131.08	\$112.34	See Web

7/16 DIN MALE RIGHT ANGLE TO 7/16 DIN
MALE RIGHT ANGLE



Low PIM Corrugated Cable Assemblies

SPP-250-LLPL Coax, 50 Ohm

Part No. PE3C4144	Cable Dia.	Attn. @ 1 GHz	Power @ 1 GHz
1 piece price shown. See web or call for volume pricing.	0.280" dia.	dB/100ft	W
12" 24" 36" 48"	60"	50CM	Custom Len.
\$120.44 \$125.92 \$131.60 \$137.18	\$142.76	\$124.02	See Web

7/16 DIN FEMALE TO N MALE



Low PIM Corrugated Cable Assemblies

SPP-250-LLPL Coax, 50 Ohm

Part No. PE3C5856	Cable Dia.	Attn. @ 1 GHz	Power @ 1 GHz
1 piece price shown. See web or call for volume pricing.	0.280" dia.	dB/100ft	W
12" 24" 36" 48"	60"	50CM	Custom Len.
\$86.23 \$91.81 \$97.39 \$102.96	\$108.54	\$89.80	See Web

7/16 DIN FEMALE TO QMA MALE



Low PIM Corrugated Cable Assemblies

SPP-250-LLPL Coax, 50 Ohm

Part No. PE3C5857	Cable Dia.	Attn. @ 1 GHz	Power @ 1 GHz
1 piece price shown. See web or call for volume pricing.	0.280" dia.	dB/100ft	W
12" 24" 36" 48"	60"	50CM	Custom Len.
\$82.62 \$88.20 \$93.78 \$99.36	\$104.94	\$86.20	See Web

7/16 DIN FEMALE TO SMA MALE



Low PIM Corrugated Cable Assemblies

Part No. PE3C5858	Cable Dia.	Attn. @ 1 GHz	Power @ 1 GHz
1 piece price shown. See web or call for volume pricing.	0.280" dia.	dB/100ft	W
12" 24" 36" 48"	60"	50CM	Custom Len.
\$75.40 \$80.98 \$86.56 \$92.14	\$97.72	\$78.97	See Web

10-32 MALE TO 10-32 MALE



Standard Flexible Cable Assemblies

RG174A/U Coax, 50 Ohm

Part No. PE36520	Cable Dia.	Attn. @ 1 GHz	Power @ 1 GHz
1 piece price shown. See web or call for volume pricing.	0.100" dia.	32 dB/100ft	16 W
12" 24" 36" 48"	60"	72"	Custom Len.
\$66.38 \$66.95 \$64.70 \$68.15	\$68.74	\$69.32	See Web

RG178B/U Coax, 50 Ohm

Part No. PE36522	Cable Dia.	Attn. @ 1 GHz	Power @ 1 GHz
1 piece price shown. See web or call for volume pricing.	0.072" dia.	38 dB/100ft	78 W
12" 24" 36" 48"	60"	72"	Custom Len.
\$89.22 \$90.16 \$96.69 \$92.10	\$98.89	\$94.01	See Web

RG316/U Coax, 50 Ohm

Part No. PE36524	Cable Dia.	Attn. @ 1 GHz	Power @ 1 GHz
1 piece price shown. See web or call for volume pricing.	0.098" dia.	38 dB/100ft	160 W
12" 24" 36" 48"	60"	72"	Custom Len.
\$67.83 \$70.71 \$73.60 \$81.46	\$84.64	\$87.83	See Web

10-32 MALE TO 10-32 MALE
RIGHT ANGLE



Standard Flexible Cable Assemblies

RG174A/U Coax, 50 Ohm

Part No. PE36526	Cable Dia.	Attn. @ 1 GHz	Power @ 1 GHz
1 piece price shown. See web or call for volume pricing.	0.100" dia.	32 dB/100ft	16 W
12" 24" 36" 48"	60"	72"	Custom Len.
\$70.79 \$67.20 \$67.64 \$68.08	\$68.50	\$68.94	See Web

RG178B/U Coax, 50 Ohm

Part No. PE36528	Cable Dia.	Attn. @ 1 GHz	Power @ 1 GHz
1 piece price shown. See web or call for volume pricing.	0.072" dia.	44 dB/100ft	78 W
12" 24" 36" 48"	60"	72"	Custom Len.
\$86.88 \$87.83 \$88.78 \$89.75	\$90.70	\$91.66	See Web

RG316/U Coax, 50 Ohm

Part No. PE36530	Cable Dia.	Attn. @ 1 GHz	Power @ 1 GHz
1 piece price shown. See web or call for volume pricing.	0.098" dia.	38 dB/100ft	160 W
12" 24" 36" 48"	60"	72"	Custom Len.
\$68.13 \$71.02 \$73.90 \$76.79	\$79.69	\$82.57	See Web

10-32 MALE TO BNC MALE



Standard Flexible Cable Assemblies

RG174A/U Coax, 50 Ohm

Part No. PE3C3275	Cable Dia.	Attn. @ 1 GHz	Power @ 1 GHz
1 piece price shown. See web or call for volume pricing.	0.110" dia.	32 dB/100ft	17 W
12" 24" 36" 48"	60"	72"	Custom Len.
\$50.43 \$51.00 \$51.59 \$52.20	\$52.78	\$53.37	See Web

RG178B/U Coax, 50 Ohm

Part No. PE36540	Cable Dia.	Attn. @ 1 GHz	Power @ 1 GHz
1 piece price shown. See web or call for volume pricing.	0.072" dia.	44 dB/100ft	78 W
12" 24" 36" 48"	60"	72"	Custom Len.
\$82.29 \$83.35 \$84.41 \$84.51	\$81.48	\$82.42	See Web

RG316/U Coax, 50 Ohm

Part No. PE3C3424	Cable Dia.	Attn. @ 1 GHz	Power @ 1 GHz
1 piece price shown. See web or call for volume pricing.	0.102" dia.	38 dB/100ft	160 W
12" 24" 36" 48"	60"	72"	Custom Len.
\$48.48 \$51.61 \$54.31 \$57.20	\$61.23	\$64.41	See Web

10-32 MALE RIGHT ANGLE TO 10-32
MALE RIGHT ANGLE



Standard Flexible Cable Assemblies

RG174A/U Coax, 50 Ohm

Part No. PE36532	Cable Dia.	Attn. @ 1 GHz	Power @ 1 GHz
1 piece price shown. See web or call for volume pricing.	0.100" dia.	32 dB/100ft	16 W
12" 24" 36" 48"	60"	72"	Custom Len.
\$65.68 \$66.15 \$66.58 \$67.01	\$67.47	\$67.90	See Web

RG178B/U Coax, 50 Ohm

Part No. PE36534	Cable Dia.	Attn. @ 1 GHz	Power @ 1 GHz
1 piece price shown. See web or call for volume pricing.	0.072" dia.	44 dB/100ft	78 W
12" 24" 36" 48"	60"	72"	Custom Len.
\$94.95 \$95.91 \$96.87 \$97.83	\$98.79	\$106.05	See Web

RG316/U Coax, 50 Ohm

Cable Assemblies

See Our Website For Current Pricing & Real-Time Stock Availability!

Continued on Next Page

For Custom Lengths, Metric Lengths or Special Configurations, Please call (949) 261-1920

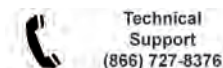

Technical Support
(866) 727-8376



Same-Day Shipping,
Even Custom
Cable Assemblies

For our complete selection of cable assemblies, please visit our website

Part No. PE36536	Cable Dia.	Attn. @ 1 GHz	Power @ 1 GHz
1 piece price shown. See web or call for volume pricing.			
12"	24"	36"	48"
\$68.25	\$71.27	\$74.27	\$77.26
		\$80.26	\$88.27
			See Web

10-32 FEMALE TO BNC MALE



Standard Flexible Cable Assemblies

RG178B/U Coax, 50 Ohm

Part No. PE3W03496	Cable Dia.	Attn. @ 1 GHz	Power @ 1 GHz
1 piece price shown. See web or call for volume pricing.			
12"	24"	36"	48"
\$67.38	\$68.41	\$69.44	\$70.46
		\$71.49	\$68.03
			See Web

BMA PLUG BULKHEAD TO BMA PLUG BULKHEAD

SEE MOUNTING HOLE SECTION ON PAGE 369



Formable Cable Assemblies

PE-SR402FLJ Coax, 50 Ohm

Part No. PE3C4899	Cable Dia.	Attn. @ 1 GHz	Power @ 1 GHz
1 piece price shown. See web or call for volume pricing.			
6"	12"	24"	36"
\$70.53	\$74.19	\$81.53	\$88.86
		\$103.52	-
			See Web

PE-SR405FLJ Coax, 50 Ohm

Part No. PE3C4844	Cable Dia.	Attn. @ 1 GHz	Power @ 1 GHz
1 piece price shown. See web or call for volume pricing.			
6"	12"	24"	36"
\$72.36	\$76.13	\$83.65	\$91.17
		\$106.23	-
			See Web

Flexible Cable Assemblies

RG316/U Coax, 50 Ohm

Part No. PE3C4936	Cable Dia.	Attn. @ 1 GHz	Power @ 1 GHz
1 piece price shown. See web or call for volume pricing.			
6"	12"	24"	36"
\$109.22	\$110.63	\$113.42	\$116.22
		\$121.83	-
			See Web

RG400/U Coax, 50 Ohm

Part No. PE3C4950	Cable Dia.	Attn. @ 1 GHz	Power @ 1 GHz
1 piece price shown. See web or call for volume pricing.			
6"	12"	24"	36"
\$84.60	\$87.98	\$94.74	\$101.50
		\$115.04	-
			See Web

LMR-100A-PVC Coax, 50 Ohm

Part No. PE3C4921	Cable Dia.	Attn. @ 1 GHz	Power @ 1 GHz
1 piece price shown. See web or call for volume pricing.			
6"	12"	24"	36"
\$103.41	\$103.79	\$104.52	\$105.26
		\$106.74	-
			See Web

Semi-Rigid Cable Assemblies

RG405/U Coax, 50 Ohm

Part No. PE3C4872	Cable Dia.	Attn. @ 1 GHz	Power @ 1 GHz
1 piece price shown. See web or call for volume pricing.			
6"	12"	24"	36"
\$71.94	\$75.27	\$81.93	\$62.61
		\$101.94	-
			See Web

BMA PLUG BULKHEAD TO BMA JACK

SEE MOUNTING HOLE SECTION ON PAGE 369



Formable Cable Assemblies

PE-SR402FLJ Coax, 50 Ohm

Part No. PE3C4904	Cable Dia.	Attn. @ 1 GHz	Power @ 1 GHz
1 piece price shown. See web or call for volume pricing.			
6"	12"	24"	36"
\$125.65	\$129.31	\$136.65	\$143.97
		\$158.63	-
			See Web

PE-SR405FLJ Coax, 50 Ohm

Part No. PE3C4852	Cable Dia.	Attn. @ 1 GHz	Power @ 1 GHz
1 piece price shown. See web or call for volume pricing.			
6"	12"	24"	36"
\$115.66	\$119.43	\$126.96	\$134.48
		\$149.53	-
			See Web

Flexible Cable Assemblies

RG316/U Coax, 50 Ohm

Part No. PE3C4940	Cable Dia.	Attn. @ 1 GHz	Power @ 1 GHz
1 piece price shown. See web or call for volume pricing.			
6"	12"	24"	36"
\$139.15	\$140.57	\$143.36	\$146.16
		\$151.77	-
			See Web

RG400/U Coax, 50 Ohm

Part No. PE3C4953	Cable Dia.	Attn. @ 1 GHz	Power @ 1 GHz
1 piece price shown. See web or call for volume pricing.			
6"	12"	24"	36"
\$153.04	\$156.43	\$163.20	\$169.96
		\$183.49	-
			See Web

LMR-100A-PVC Coax, 50 Ohm

Part No. PE3C4925	Cable Dia.	Attn. @ 1 GHz	Power @ 1 GHz
1 piece price shown. See web or call for volume pricing.			
6"	12"	24"	36"
\$133.35	\$133.72	\$134.46	\$135.19
		\$136.67	-
			See Web

Semi-Rigid Cable Assemblies

RG405/U Coax, 50 Ohm

Part No. PE3C4879	Cable Dia.	Attn. @ 1 GHz	Power @ 1 GHz
1 piece price shown. See web or call for volume pricing.			
6"	12"	24"	36"
\$115.25	\$118.57	\$125.23	\$131.90
		\$145.24	-
			See Web

BMA PLUG BULKHEAD TO BMA JACK BULKHEAD

SEE MOUNTING HOLE SECTION ON PAGE 369



Formable Cable Assemblies

PE-SR405FLJ Coax, 50 Ohm

Part No. PE3C4851	Cable Dia.	Attn. @ 1 GHz	Power @ 1 GHz
1 piece price shown. See web or call for volume pricing.			
6"	12"	24"	36"
\$91.35	\$95.11	\$102.64	\$110.17
		\$125.21	-
			See Web

Semi-Rigid Cable Assemblies

RG405/U Coax, 50 Ohm

Part No. PE3C4878	Cable Dia.	Attn. @ 1 GHz	Power @ 1 GHz
1 piece price shown. See web or call for volume pricing.			
6"	12"	24"	36"
\$90.92	\$94.26	\$100.92	\$107.59
		\$120.93	-
			See Web

BMA PLUG BULKHEAD TO BMA JACK 2 HOLE FLANGE

SEE MOUNTING HOLE SECTION ON PAGE 369



Formable Cable Assemblies

PE-SR402FLJ Coax, 50 Ohm

Part No. PE3C4903	Cable Dia.	Attn. @ 1 GHz	Power @ 1 GHz
1 piece price shown. See web or call for volume pricing.			
6"	12"	24"	36"
\$84.53	\$88.21	\$95.54	\$102.87
		\$117.52	-
			See Web

PE-SR405FLJ Coax, 50 Ohm

Part No. PE3C4850	Cable Dia.	Attn. @ 1 GHz	Power @ 1 GHz
1 piece price shown. See web or call for volume pricing.			
6"	12"	24"	36"
\$97.09	\$100.87	\$108.39	\$115.91
		\$130.97	-
			See Web

Flexible Cable Assemblies

RG316/U Coax, 50 Ohm

Part No. PE3C4939	Cable Dia.	Attn. @ 1 GHz	Power @ 1 GHz
1 piece price shown. See web or call for volume pricing.			
6"	12"	24"	36"
\$104.81	\$106.23	\$109.01	\$111.82
		\$117.43	-
			See Web

LMR-100A-PVC Coax, 50 Ohm

Part No. PE3C4924	Cable Dia.	Attn. @ 1 GHz	Power @ 1 GHz
1 piece price shown. See web or call for volume pricing.			
6"	12"	24"	36"
\$99.01	\$99.38	\$100.12	\$100.86
		\$102.32	-
			See Web

Semi-Rigid Cable Assemblies

RG405/U Coax, 50 Ohm

Part No. PE3C4877	Cable Dia.	Attn. @ 1 GHz	Power @ 1 GHz
1 piece price shown. See web or call for volume pricing.			
6"	12"	24"	36"
\$96.68	\$100.00	\$106.66	\$113.33
		\$126.67	-
			See Web

BMA PLUG BULKHEAD TO BMA JACK RIGHT ANGLE 2 HOLE FLANGE

SEE MOUNTING HOLE SECTION ON PAGE 369



Formable Cable Assemblies

PE-SR402FLJ Coax, 50 Ohm

Part No. PE3C4905	Cable Dia.	Attn. @ 1 GHz	Power @ 1 GHz
1 piece price shown. See web or call for volume pricing.			
6"	12"	24"	36"
\$113.58	\$117.25	\$124.59	\$131.91
		\$146.57	-
			See Web

PE-SR405FLJ Coax, 50 Ohm

Part No. PE3C4853	Cable Dia.	Attn. @ 1 GHz	Power @ 1 GHz
1 piece price shown. See web or call for volume pricing.			
6"	12"	24"	36"
\$108.98	\$112.75	\$120.27	\$127.80
		\$142.85	-
			See Web

Flexible Cable Assemblies

RG400/U Coax, 50 Ohm

Part No. PE3C4954	Cable Dia.	Attn. @ 1 GHz	Power @ 1 GHz
1 piece price shown. See web or call for volume pricing.			
6"	12"	24"	36"
\$106.69	\$110.09	\$116.85	\$123.61
		\$137.15	-
			See Web

Semi-Rigid Cable Assemblies

RG405/U Coax, 50 Ohm

Part No. PE3C4880	Cable Dia.	Attn. @ 1 GHz	Power @ 1 GHz
1 piece price shown. See web or call for volume pricing.			
6"	12"	24"	36"
\$108.57	\$111.90	\$118.55	\$125.22
		\$138.56	-
			See Web

Cable Assemblies See Our Website For Current Pricing & Real-Time Stock Availability!

*Coax Performance at 1 GHz Notes: Cable assembly max frequency may be lower than connector or coax max frequency

For our complete selection of cable assemblies, please visit our website

Cable Assemblies

See Our Website For Current Pricing & Real-Time Stock Availability!

BMA PLUG BULKHEAD TO BNC MALE						
SEE MOUNTING HOLE SECTION ON PAGE 369						
Formable Cable Assemblies						
PE-SR402FLJ Coax, 50 Ohm						
Part No. PE3C4918	Cable Dia.		Attn. @ 1 GHz	Power @ 1 GHz		
1 piece price shown. See web or call for volume pricing.			0.161" dia.	12 dB/100ft	303 W	
6"	12"	24"	36"	60"	-	Custom Len.
\$69.82	\$73.50	\$80.82	\$88.15	\$102.81	-	See Web
Flexible Cable Assemblies						
RG316/U Coax, 50 Ohm						
Part No. PE3C4949	Cable Dia.		Attn. @ 1 GHz	Power @ 1 GHz		
1 piece price shown. See web or call for volume pricing.			0.098" dia.	58 dB/100ft	160 W	
6"	12"	24"	36"	60"	-	Custom Len.
\$69.23	\$70.64	\$73.43	\$76.23	\$81.84	-	See Web
RG400/U Coax, 50 Ohm						
Part No. PE3C4963	Cable Dia.		Attn. @ 1 GHz	Power @ 1 GHz		
1 piece price shown. See web or call for volume pricing.			0.195" dia.	15 dB/100ft	600 W	
6"	12"	24"	36"	60"	-	Custom Len.
\$58.30	\$61.69	\$68.44	\$75.20	\$88.74	-	See Web
LMR-100A-PVC Coax, 50 Ohm						
Part No. PE3C4935	Cable Dia.		Attn. @ 1 GHz	Power @ 1 GHz		
1 piece price shown. See web or call for volume pricing.			0.110" dia.	24 dB/100ft	W	
6"	12"	24"	36"	60"	-	Custom Len.
\$63.41	\$63.79	\$64.53	\$65.27	\$66.73	-	See Web

BMA PLUG BULKHEAD TO N MALE						
SEE MOUNTING HOLE SECTION ON PAGE 369						
Formable Cable Assemblies						
PE-SR402FLJ Coax, 50 Ohm						
Part No. PE3C4912	Cable Dia.		Attn. @ 1 GHz	Power @ 1 GHz		
1 piece price shown. See web or call for volume pricing.			0.161" dia.	12 dB/100ft	303 W	
6"	12"	24"	36"	60"	-	Custom Len.
\$62.41	\$66.08	\$73.41	\$80.74	\$95.40	-	See Web
PE-SR405FLJ Coax, 50 Ohm						
Part No. PE3C4860	Cable Dia.		Attn. @ 1 GHz	Power @ 1 GHz		
1 piece price shown. See web or call for volume pricing.			0.105" dia.	20 dB/100ft	122 W	
6"	12"	24"	36"	60"	-	Custom Len.
\$63.37	\$67.14	\$74.66	\$82.18	\$97.24	-	See Web
Flexible Cable Assemblies						
RG316/U Coax, 50 Ohm						
Part No. PE3C4945	Cable Dia.		Attn. @ 1 GHz	Power @ 1 GHz		
1 piece price shown. See web or call for volume pricing.			0.098" dia.	58 dB/100ft	160 W	
6"	12"	24"	36"	60"	-	Custom Len.
\$89.82	\$78.56	\$79.97	\$82.77	\$85.56	-	See Web
RG400/U Coax, 50 Ohm						
Part No. PE3C4959	Cable Dia.		Attn. @ 1 GHz	Power @ 1 GHz		
1 piece price shown. See web or call for volume pricing.			0.195" dia.	15 dB/100ft	600 W	
6"	12"	24"	36"	60"	-	Custom Len.
\$68.20	\$71.59	\$78.34	\$85.11	\$98.64	-	See Web
LMR-100A-PVC Coax, 50 Ohm						
Part No. PE3C4931	Cable Dia.		Attn. @ 1 GHz	Power @ 1 GHz		
1 piece price shown. See web or call for volume pricing.			0.110" dia.	24 dB/100ft	W	
6"	12"	24"	36"	60"	-	Custom Len.
\$72.75	\$73.12	\$73.86	\$74.60	\$76.08	-	See Web
Semi-Rigid Cable Assemblies						
RG405/U Coax, 50 Ohm						
Part No. PE3C4887	Cable Dia.		Attn. @ 1 GHz	Power @ 1 GHz		
1 piece price shown. See web or call for volume pricing.			* dia.	22 dB/100ft	130 W	
6"	12"	24"	36"	60"	-	Custom Len.
\$62.95	\$66.29	\$72.94	\$79.61	\$92.95	-	See Web

BMA PLUG BULKHEAD TO SMA MALE						
SEE MOUNTING HOLE SECTION ON PAGE 369						
Formable Cable Assemblies						
PE-SR402FLJ Coax, 50 Ohm						
Part No. PE3C4906	Cable Dia.		Attn. @ 1 GHz	Power @ 1 GHz		
1 piece price shown. See web or call for volume pricing.			0.161" dia.	12 dB/100ft	303 W	
6"	12"	24"	36"	60"	-	Custom Len.
\$54.72	\$58.39	\$65.72	\$73.05	\$87.71	-	See Web
PE-SR405FLJ Coax, 50 Ohm						
Part No. PE3C4854	Cable Dia.		Attn. @ 1 GHz	Power @ 1 GHz		
1 piece price shown. See web or call for volume pricing.			0.105" dia.	20 dB/100ft	122 W	
6"	12"	24"	36"	60"	-	Custom Len.
\$56.44	\$60.21	\$67.73	\$75.25	\$90.31	-	See Web

Flexible Cable Assemblies						
RG316/U Coax, 50 Ohm						
Part No. PE3C4942	Cable Dia.		Attn. @ 1 GHz	Power @ 1 GHz		
1 piece price shown. See web or call for volume pricing.			0.098" dia.	58 dB/100ft	160 W	
6"	12"	24"	36"	60"	-	Custom Len.
\$72.53	\$73.94	\$76.73	\$79.54	\$85.15	-	See Web
RG400/U Coax, 50 Ohm						
Part No. PE3C4955	Cable Dia.		Attn. @ 1 GHz	Power @ 1 GHz		
1 piece price shown. See web or call for volume pricing.			0.195" dia.	15 dB/100ft	600 W	
6"	12"	24"	36"	60"	-	Custom Len.
\$62.80	\$66.18	\$72.94	\$79.71	\$93.24	-	See Web
LMR-100A-PVC Coax, 50 Ohm						
Part No. PE3C4927	Cable Dia.		Attn. @ 1 GHz	Power @ 1 GHz		
1 piece price shown. See web or call for volume pricing.			0.110" dia.	24 dB/100ft	W	
6"	12"	24"	36"	60"	-	Custom Len.
\$66.71	\$67.10	\$67.84	\$68.56	\$70.04	-	See Web

BMA PLUG BULKHEAD TO SMA MALE RIGHT ANGLE						
SEE MOUNTING HOLE SECTION ON PAGE 369						
Formable Cable Assemblies						
PE-SR402FLJ Coax, 50 Ohm						
Part No. PE3C4909	Cable Dia.		Attn. @ 1 GHz	Power @ 1 GHz		
1 piece price shown. See web or call for volume pricing.			0.161" dia.	12 dB/100ft	303 W	
6"	12"	24"	36"	60"	-	Custom Len.
\$57.37	\$61.04	\$68.38	\$75.70	\$90.36	-	See Web
PE-SR405FLJ Coax, 50 Ohm						
Part No. PE3C4857	Cable Dia.		Attn. @ 1 GHz	Power @ 1 GHz		
1 piece price shown. See web or call for volume pricing.			0.105" dia.	20 dB/100ft	122 W	
6"	12"	24"	36"	60"	-	Custom Len.
\$58.34	\$62.10	\$69.63	\$77.16	\$92.20	-	See Web

Flexible Cable Assemblies						
RG316/U Coax, 50 Ohm						
Part No. PE3C4386	Cable Dia.		Attn. @ 1 GHz	Power @ 1 GHz		
1 piece price shown. See web or call for volume pricing.			0.098" dia.	58 dB/100ft	160 W	
6"	12"	24"	36"	60"	-	Custom Len.
\$87.28	\$88.69	\$91.47	\$94.28	\$99.89	-	See Web
RG400/U Coax, 50 Ohm						
Part No. PE3C4957	Cable Dia.		Attn. @ 1 GHz	Power @ 1 GHz		
1 piece price shown. See web or call for volume pricing.			0.195" dia.	15 dB/100ft	600 W	
6"	12"	24"	36"	60"	-	Custom Len.
\$72.71	\$76.10	\$82.85	\$89.61	\$103.15	-	See Web
LMR-100A-PVC Coax, 50 Ohm						
Part No. PE3C4929	Cable Dia.		Attn. @ 1 GHz	Power @ 1 GHz		
1 piece price shown. See web or call for volume pricing.			0.110" dia.	24 dB/100ft	W	
6"	12"	24"	36"	60"	-	Custom Len.
\$76.73	\$78.27	\$79.01	\$78.55	\$80.00	-	See Web
Semi-Rigid Cable Assemblies						
RG405/U Coax, 50 Ohm						
Part No. PE3C4884	Cable Dia.		Attn. @ 1 GHz	Power @ 1 GHz		
1 piece price shown. See web or call for volume pricing.			* dia.	22 dB/100ft	130 W	
6"	12"	24"	36"	60"	-	Custom Len.
\$57.91	\$61.25	\$67.91	\$74.58	\$87.92	-	See Web

BMA PLUG BULKHEAD TO SMP FEMALE						
SEE MOUNTING HOLE SECTION ON PAGE 369						
Formable Cable Assemblies						
PE-SR405FLJ Coax, 50 Ohm						
Part No. PE3C4866	Cable Dia.		Attn. @ 1 GHz	Power @ 1 GHz		
1 piece price shown. See web or call for volume pricing.			0.105" dia.	20 dB/100ft	122 W	
6"	12"	24"	36"	60"	-	Custom Len.
\$65.03	\$68.79	\$76.32	\$83.85	\$98.89	-	See Web
Semi-Rigid Cable Assemblies						
RG405/U Coax, 50 Ohm						
Part No. PE3C4893	Cable Dia.		Attn. @ 1 GHz	Power @ 1 GHz		
1 piece price shown. See web or call for volume pricing.			* dia.	22 dB/100ft	130 W	
6"	12"	24"	36"	60"	-	Custom Len.
\$64.61	\$67.94	\$74.60	\$81.27	\$94.60	-	See Web

For Custom Lengths, Metric Lengths or Special Configurations, Please call (949) 261-1920

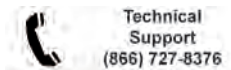

For our complete selection of cable assemblies, please visit our website

Cable Assemblies

See Our Website For Current Pricing & Real-Time Stock Availability!

BMA PLUG BULKHEAD TO SMP FEMALE RIGHT ANGLE				
SEE MOUNTING HOLE SECTION ON PAGE 369				
Formable Cable Assemblies				
PE-SR405FLJ Coax, 50 Ohm				
Part No. PE3C4869	Cable Dia.	Attn. @ 1 GHz	Power @ 1 GHz	
1 piece price shown. See web or call for volume pricing.				
6"	12"	24"	36"	60"
\$76.78	\$80.55	\$88.08	\$95.60	\$110.65
				Custom Len.
				See Web
Semi-Rigid Cable Assemblies				
RG405/U Coax, 50 Ohm				
Part No. PE3C4896	Cable Dia.	Attn. @ 1 GHz	Power @ 1 GHz	
1 piece price shown. See web or call for volume pricing.				
6"	12"	24"	36"	60"
\$76.37	\$79.70	\$86.35	\$93.02	\$106.36
				Custom Len.
				See Web
Formable Cable Assemblies				
PE-SR402FLJ Coax, 50 Ohm				
Part No. PE3C4915	Cable Dia.	Attn. @ 1 GHz	Power @ 1 GHz	
1 piece price shown. See web or call for volume pricing.				
6"	12"	24"	36"	60"
\$59.24	\$62.92	\$70.25	\$77.57	\$92.23
				Custom Len.
				See Web
Formable Cable Assemblies				
PE-SR405FLJ Coax, 50 Ohm				
Part No. PE3C4863	Cable Dia.	Attn. @ 1 GHz	Power @ 1 GHz	
1 piece price shown. See web or call for volume pricing.				
6"	12"	24"	36"	60"
\$60.21	\$63.98	\$71.50	\$79.03	\$94.07
				Custom Len.
				See Web
Flexible Cable Assemblies				
RG316/U Coax, 50 Ohm				
Part No. PE3C4947	Cable Dia.	Attn. @ 1 GHz	Power @ 1 GHz	
1 piece price shown. See web or call for volume pricing.				
6"	12"	24"	36"	60"
\$86.76	\$88.17	\$90.95	\$93.76	\$99.37
				Custom Len.
				See Web
Formable Cable Assemblies				
RG400/U Coax, 50 Ohm				
Part No. PE3C4961	Cable Dia.	Attn. @ 1 GHz	Power @ 1 GHz	
1 piece price shown. See web or call for volume pricing.				
6"	12"	24"	36"	60"
\$62.76	\$66.14	\$72.90	\$79.67	\$93.20
				Custom Len.
				See Web
Formable Cable Assemblies				
LMR-100A-PVC Coax, 50 Ohm				
Part No. PE3C4933	Cable Dia.	Attn. @ 1 GHz	Power @ 1 GHz	
1 piece price shown. See web or call for volume pricing.				
6"	12"	24"	36"	60"
\$80.94	\$81.32	\$82.06	\$82.80	\$84.26
				Custom Len.
				See Web
Semi-Rigid Cable Assemblies				
RG405/U Coax, 50 Ohm				
Part No. PE3C4890	Cable Dia.	Attn. @ 1 GHz	Power @ 1 GHz	
1 piece price shown. See web or call for volume pricing.				
6"	12"	24"	36"	60"
\$59.78	\$63.12	\$69.78	\$76.45	\$89.79
				Custom Len.
				See Web
Formable Cable Assemblies				
PE-SR402FLJ Coax, 50 Ohm				
Part No. PE3C4901	Cable Dia.	Attn. @ 1 GHz	Power @ 1 GHz	
1 piece price shown. See web or call for volume pricing.				
6"	12"	24"	36"	60"
\$180.77	\$184.43	\$191.76	\$199.09	\$213.75
				Custom Len.
				See Web
Formable Cable Assemblies				
PE-SR405FLJ Coax, 50 Ohm				
Part No. PE3C4848	Cable Dia.	Attn. @ 1 GHz	Power @ 1 GHz	
1 piece price shown. See web or call for volume pricing.				
6"	12"	24"	36"	60"
\$158.97	\$162.74	\$170.26	\$177.78	\$192.84
				Custom Len.
				See Web
Flexible Cable Assemblies				
RG316/U Coax, 50 Ohm				
Part No. PE3C4938	Cable Dia.	Attn. @ 1 GHz	Power @ 1 GHz	
1 piece price shown. See web or call for volume pricing.				
6"	12"	24"	36"	60"
\$169.09	\$170.50	\$173.29	\$176.10	\$181.70
				Custom Len.
				See Web
Formable Cable Assemblies				
RG400/U Coax, 50 Ohm				
Part No. PE3C4951	Cable Dia.	Attn. @ 1 GHz	Power @ 1 GHz	
1 piece price shown. See web or call for volume pricing.				
6"	12"	24"	36"	60"
\$221.50	\$224.89	\$231.65	\$238.41	\$251.95
				Custom Len.
				See Web

LMR-100A-PVC Coax, 50 Ohm				
Part No. PE3C4923	Cable Dia.	Attn. @ 1 GHz	Power @ 1 GHz	
1 piece price shown. See web or call for volume pricing.				
6"	12"	24"	36"	60"
\$163.28	\$163.65	\$164.39	\$165.13	\$166.60
				Custom Len.
				See Web
Semi-Rigid Cable Assemblies				
RG405/U Coax, 50 Ohm				
Part No. PE3C4875	Cable Dia.	Attn. @ 1 GHz	Power @ 1 GHz	
1 piece price shown. See web or call for volume pricing.				
6"	12"	24"	36"	60"
\$158.55	\$161.88	\$168.54	\$175.21	\$188.55
				Custom Len.
				See Web
Formable Cable Assemblies				
PE-SR402FLJ Coax, 50 Ohm				
Part No. PE3C4920	Cable Dia.	Attn. @ 1 GHz	Power @ 1 GHz	
1 piece price shown. See web or call for volume pricing.				
6"	12"	24"	36"	60"
\$124.94	\$128.61	\$135.94	\$143.27	\$157.93
				Custom Len.
				See Web
Flexible Cable Assemblies				
RG316/U Coax, 50 Ohm				
Part No. PE3C4948	Cable Dia.	Attn. @ 1 GHz	Power @ 1 GHz	
1 piece price shown. See web or call for volume pricing.				
6"	12"	24"	36"	60"
\$99.16	\$100.58	\$103.36	\$106.17	\$111.78
				Custom Len.
				See Web
Formable Cable Assemblies				
RG400/U Coax, 50 Ohm				
Part No. PE3C4964	Cable Dia.	Attn. @ 1 GHz	Power @ 1 GHz	
1 piece price shown. See web or call for volume pricing.				
6"	12"	24"	36"	60"
\$126.75	\$130.13	\$136.90	\$143.66	\$157.19
				Custom Len.
				See Web
Formable Cable Assemblies				
LMR-100A-PVC Coax, 50 Ohm				
Part No. PE3C4934	Cable Dia.	Attn. @ 1 GHz	Power @ 1 GHz	
1 piece price shown. See web or call for volume pricing.				
6"	12"	24"	36"	60"
\$93.35	\$93.73	\$94.47	\$95.20	\$96.68
				Custom Len.
				See Web
Formable Cable Assemblies				
PE-SR402FLJ Coax, 50 Ohm				
Part No. PE3C4914	Cable Dia.	Attn. @ 1 GHz	Power @ 1 GHz	
1 piece price shown. See web or call for volume pricing.				
6"	12"	24"	36"	60"
\$117.52	\$121.20	\$128.52	\$135.86	\$150.51
				Custom Len.
				See Web
Formable Cable Assemblies				
PE-SR405FLJ Coax, 50 Ohm				
Part No. PE3C4862	Cable Dia.	Attn. @ 1 GHz	Power @ 1 GHz	
1 piece price shown. See web or call for volume pricing.				
6"	12"	24"	36"	60"
\$106.67	\$110.45	\$117.97	\$125.49	\$140.55
				Custom Len.
				See Web
Flexible Cable Assemblies				
RG316/U Coax, 50 Ohm				
Part No. PE3C4944	Cable Dia.	Attn. @ 1 GHz	Power @ 1 GHz	
1 piece price shown. See web or call for volume pricing.				
6"	12"	24"	36"	60"
\$108.49	\$109.91	\$112.70	\$115.51	\$121.11
				Custom Len.
				See Web
Formable Cable Assemblies				
RG400/U Coax, 50 Ohm				
Part No. PE3C4960	Cable Dia.	Attn. @ 1 GHz	Power @ 1 GHz	
1 piece price shown. See web or call for volume pricing.				
6"	12"	24"	36"	60"
\$136.66	\$140.05	\$146.80	\$153.56	\$167.10
				Custom Len.
				See Web
Formable Cable Assemblies				
LMR-100A-PVC Coax, 50 Ohm				
Part No. PE3C4930	Cable Dia.	Attn. @ 1 GHz	Power @ 1 GHz	
1 piece price shown. See web or call for volume pricing.				
6"	12"	24"	36"	60"
\$102.68	\$9.95	\$103.80	\$104.53	\$106.01
				Custom Len.
				See Web
Semi-Rigid Cable Assemblies				
RG405/U Coax, 50 Ohm				
Part No. PE3C4889	Cable Dia.	Attn. @ 1 GHz	Power @ 1 GHz	
1 piece price shown. See web or call for volume pricing.				
6"	12"	24"	36"	60"
\$106.26	\$109.59	\$116.24	\$122.91	\$136.25
				Custom Len.
				See Web
Formable Cable Assemblies				
PE-SR402FLJ Coax, 50 Ohm				
Part No. PE3C4938	Cable Dia.	Attn. @ 1 GHz	Power @ 1 GHz	
1 piece price shown. See web or call for volume pricing.				
6"	12"	24"	36"	60"
\$106.26	\$109.59	\$116.24	\$122.91	\$136.25
				Custom Len.
				See Web

*Coax Performance at 1 GHz Notes: Cable assembly max frequency may be lower than connector or coax max frequency

For our complete selection of cable assemblies, please visit our website

PE-SR402FLJ Coax, 50 Ohm						
Part No. PE3C4908				Cable Dia.	Attn. @ 1 GHz	Power @ 1 GHz
1 piece price shown. See web or call for volume pricing.						
6"	12"	24"	36"	0.161" dia.	12 dB/100ft	303 W
\$109.84	\$113.51	\$120.84	\$128.17	60"	-	Custom Len.
				See Web		

PE-SR405FLJ Coax, 50 Ohm						
Part No. PE3C4856				Cable Dia.	Attn. @ 1 GHz	Power @ 1 GHz
1 piece price shown. See web or call for volume pricing.						
6"	12"	24"	36"	0.105" dia.	20 dB/100ft	122 W
\$99.74	\$103.52	\$111.04	\$126.09	60"	-	Custom Len.
				See Web		

Flexible Cable Assemblies						
RG316/U Coax, 50 Ohm						
Part No. PE3C4941				Cable Dia.	Attn. @ 1 GHz	Power @ 1 GHz
1 piece price shown. See web or call for volume pricing.						
6"	12"	24"	36"	0.098" dia.	58 dB/100ft	160 W
\$102.47	\$103.87	\$106.66	\$109.47	60"	-	Custom Len.
				See Web		

RG400/U Coax, 50 Ohm						
Part No. PE3C4956				Cable Dia.	Attn. @ 1 GHz	Power @ 1 GHz
1 piece price shown. See web or call for volume pricing.						
6"	12"	24"	36"	0.195" dia.	15 dB/100ft	600 W
\$131.26	\$134.64	\$141.40	\$148.16	60"	-	Custom Len.
				See Web		

LMR-100A-PVC Coax, 50 Ohm						
Part No. PE3C4926				Cable Dia.	Attn. @ 1 GHz	Power @ 1 GHz
1 piece price shown. See web or call for volume pricing.						
6"	12"	24"	36"	0.110" dia.	24 dB/100ft	W
\$96.65	\$97.03	\$97.77	\$98.51	60"	-	Custom Len.
				See Web		

Semi-Rigid Cable Assemblies						
RG405/U Coax, 50 Ohm						
Part No. PE3C4883				Cable Dia.	Attn. @ 1 GHz	Power @ 1 GHz
1 piece price shown. See web or call for volume pricing.						
6"	12"	24"	36"	* dia.	22 dB/100ft	130 W
\$99.33	\$102.66	\$109.32	\$115.98	60"	-	Custom Len.
				See Web		

BMA JACK TO SMA MALE RIGHT ANGLE						
						

Formable Cable Assemblies						
PE-SR402FLJ Coax, 50 Ohm						
Part No. PE3C4911				Cable Dia.	Attn. @ 1 GHz	Power @ 1 GHz
1 piece price shown. See web or call for volume pricing.						
6"	12"	24"	36"	0.161" dia.	12 dB/100ft	303 W
\$112.49	\$116.16	\$123.50	\$130.82	60"	-	Custom Len.
				See Web		

PE-SR405FLJ Coax, 50 Ohm						
Part No. PE3C4859				Cable Dia.	Attn. @ 1 GHz	Power @ 1 GHz
1 piece price shown. See web or call for volume pricing.						
6"	12"	24"	36"	0.105" dia.	20 dB/100ft	122 W
\$101.65	\$105.41	\$112.94	\$120.46	60"	-	Custom Len.
				See Web		

Flexible Cable Assemblies						
RG316/U Coax, 50 Ohm						
Part No. PE3C4943				Cable Dia.	Attn. @ 1 GHz	Power @ 1 GHz
1 piece price shown. See web or call for volume pricing.						
6"	12"	24"	36"	0.098" dia.	58 dB/100ft	160 W
\$117.21	\$118.62	\$121.41	\$124.21	60"	-	Custom Len.
				See Web		

RG400/U Coax, 50 Ohm						
Part No. PE3C4958				Cable Dia.	Attn. @ 1 GHz	Power @ 1 GHz
1 piece price shown. See web or call for volume pricing.						
6"	12"	24"	36"	0.195" dia.	15 dB/100ft	600 W
\$141.16	\$144.55	\$151.30	\$158.07	60"	-	Custom Len.
				See Web		

LMR-100A-PVC Coax, 50 Ohm						
Part No. PE3C4928				Cable Dia.	Attn. @ 1 GHz	Power @ 1 GHz
1 piece price shown. See web or call for volume pricing.						
6"	12"	24"	36"	0.110" dia.	24 dB/100ft	W
\$106.62	\$107.01	\$107.73	\$108.47	60"	-	Custom Len.
				See Web		

Semi-Rigid Cable Assemblies						
RG405/U Coax, 50 Ohm						
Part No. PE3C4886				Cable Dia.	Attn. @ 1 GHz	Power @ 1 GHz
1 piece price shown. See web or call for volume pricing.						
6"	12"	24"	36"	* dia.	22 dB/100ft	130 W
\$101.22	\$104.55	\$111.21	\$117.88	60"	-	Custom Len.
				See Web		

BMA JACK TO SMP FEMALE						
						

Formable Cable Assemblies						
PE-SR405FLJ Coax, 50 Ohm						
Part No. PE3C4868				Cable Dia.	Attn. @ 1 GHz	Power @ 1 GHz
1 piece price shown. See web or call for volume pricing.						
6"	12"	24"	36"	0.105" dia.	20 dB/100ft	122 W
\$108.34	\$112.10	\$119.63	\$127.15	60"	-	Custom Len.
				See Web		

Semi-Rigid Cable Assemblies						
-----------------------------	--	--	--	--	--	--

RG405/U Coax, 50 Ohm						
Part No. PE3C4895				Cable Dia.	Attn. @ 1 GHz	Power @ 1 GHz
1 piece price shown. See web or call for volume pricing.						
6"	12"	24"	36"	* dia.	22 dB/100ft	130 W
\$107.91	\$111.25	\$117.91	\$124.58	60"	-	Custom Len.
				See Web		

BMA JACK TO SMP FEMALE RIGHT ANGLE						
						

Formable Cable Assemblies						
PE-SR405FLJ Coax, 50 Ohm						
Part No. PE3C4871				Cable Dia.	Attn. @ 1 GHz	Power @ 1 GHz
1 piece price shown. See web or call for volume pricing.						
6"	12"	24"	36"	0.105" dia.	20 dB/100ft	122 W
\$120.09	\$123.86	\$131.38	\$138.90	60"	-	Custom Len.
				See Web		

Semi-Rigid Cable Assemblies						
RG405/U Coax, 50 Ohm						
Part No. PE3C4898				Cable Dia.	Attn. @ 1 GHz	Power @ 1 GHz
1 piece price shown. See web or call for volume pricing.						
6"	12"	24"	36"	* dia.	22 dB/100ft	130 W
\$119.67	\$123.01	\$129.66	\$136.33	60"	-	Custom Len.
				See Web		

BMA JACK TO TNC MALE						
						

Formable Cable Assemblies						
PE-SR402FLJ Coax, 50 Ohm						
Part No. PE3C4917				Cable Dia.	Attn. @ 1 GHz	Power @ 1 GHz
1 piece price shown. See web or call for volume pricing.						
6"	12"	24"	36"	0.161" dia.	12 dB/100ft	303 W
\$114.36	\$118.03	\$125.37	\$132.69	60"	-	Custom Len.
				See Web		

PE-SR405FLJ Coax, 50 Ohm						
Part No. PE3C4865				Cable Dia.	Attn. @ 1 GHz	Power @ 1 GHz
1 piece price shown. See web or call for volume pricing.						
6"	12"	24"	36"	0.105" dia.	20 dB/100ft	122 W
\$103.52	\$107.29	\$114.81	\$122.33	60"	-	Custom Len.
				See Web		

Flexible Cable Assemblies						
RG316/U Coax, 50 Ohm						
Part No. PE3C4946				Cable Dia.	Attn. @ 1 GHz	Power @ 1 GHz
1 piece price shown. See web or call for volume pricing.						
6"	12"	24"	36"	0.098" dia.	58 dB/100ft	160 W
\$116.69	\$118.10	\$120.89	\$123.69	60"	-	Custom Len.
				See Web		

RG400/U Coax, 50 Ohm						
Part No. PE3C4962				Cable Dia.	Attn. @ 1 GHz	Power @ 1 GHz
1 piece price shown. See web or call for volume pricing.						
6"	12"	24"	36"	0.195" dia.	15 dB/100ft	600 W
\$132.09	\$135.48	\$142.23	\$149.00	60"	-	Custom Len.
				See Web		

LMR-100A-PVC Coax, 50 Ohm						
Part No. PE3C4932				Cable Dia.	Attn. @ 1 GHz	Power @ 1 GHz
1 piece price shown. See web or call for volume pricing.						
6"	12"	24"	36"	0.110" dia.	24 dB/100ft	W
\$110.88	\$111.26	\$111.99	\$112.73	60"	-	Custom Len.
				See Web		

Semi-Rigid Cable Assemblies						
RG405/U Coax, 50 Ohm						
Part No. PE3C4892				Cable Dia.	Attn. @ 1 GHz	Power @ 1 GHz
1 piece price shown. See web or call for volume pricing.						
6"	12"	24"	36"	* dia.	22 dB/100ft	130 W
\$103.09	\$106.42	\$113.08	\$119.76	60"	-	Custom Len.
				See Web		

BMA JACK BULKHEAD TO BMA JACK BULKHEAD						
SEE MOUNTING HOLE SECTION ON PAGE 369						
						

Formable Cable Assemblies						
PE-SR405FLJ Coax, 50 Ohm						
Part No. PE3C4846				Cable Dia.	Attn. @ 1 GHz	Power @ 1 GHz
1 piece price shown. See web or call for volume pricing.						
6"	12"	24"	36"	0.105" dia.	20 dB/100ft	122 W
\$110.34	\$114.10	\$121.63	\$129.16	60"	-	Custom Len.
				See Web		

Semi-Rigid Cable Assemblies						
RG405/U Coax, 50 Ohm						
Part No. PE3C4874				Cable Dia.	Attn. @ 1 GHz	Power @ 1 GHz
1 piece price shown. See web or call for volume pricing.						
6"	12"	24"	36"	* dia.	22 dB/100ft	130 W
\$109.92	\$113.25	\$119.91	\$126.58	60"	-	Custom Len.
				See Web		

BMA JACK 2 HOLE FLANGE TO BMA JACK 2 HOLE FLANGE						
SEE MOUNTING HOLE SECTION ON PAGE 369						
						

Formable Cable Assemblies						
---------------------------	--	--	--	--	--	--

Cable Assemblies

See Our Website For Current Pricing & Real-Time Stock Availability!

Continued on Next Page

For Custom Lengths, Metric Lengths or Special Configurations, Please call (949) 261-1920



For our complete selection of cable assemblies, please visit our website

Cable Assemblies

See Our Website For Current Pricing & Real-Time Stock Availability!

PE-SR402FLJ Coax, 50 Ohm						
Part No. PE3C4900	Cable Dia.	Attn. @ 1 GHz	Power @ 1 GHz			
1 piece price shown. See web or call for volume pricing.						
6"	12"	24"	36"	60"	-	Custom Len.
\$98.55	\$102.22	\$109.54	\$116.88	\$131.54	-	See Web
PE-SR405FLJ Coax, 50 Ohm						
Part No. PE3C4845	Cable Dia.	Attn. @ 1 GHz	Power @ 1 GHz			
1 piece price shown. See web or call for volume pricing.						
6"	12"	24"	36"	60"	-	Custom Len.
\$121.83	\$125.60	\$133.13	\$140.65	\$155.70	-	See Web
Flexible Cable Assemblies						
RG316/U Coax, 50 Ohm						
Part No. PE3C4937	Cable Dia.	Attn. @ 1 GHz	Power @ 1 GHz			
1 piece price shown. See web or call for volume pricing.						
6"	12"	24"	36"	60"	-	Custom Len.
\$100.41	\$101.81	\$104.61	\$107.41	\$113.02	-	See Web
LMR-100A-PVC Coax, 50 Ohm						
Part No. PE3C4922	Cable Dia.	Attn. @ 1 GHz	Power @ 1 GHz			
1 piece price shown. See web or call for volume pricing.						
6"	12"	24"	36"	60"	-	Custom Len.
\$94.59	\$94.97	\$95.71	\$96.45	\$97.92	-	See Web
Semi-Rigid Cable Assemblies						
RG405/U Coax, 50 Ohm						
Part No. PE3C4873	Cable Dia.	Attn. @ 1 GHz	Power @ 1 GHz			
1 piece price shown. See web or call for volume pricing.						
6"	12"	24"	36"	60"	-	Custom Len.
\$121.41	\$124.74	\$131.40	\$138.07	\$151.41	-	See Web
BMA JACK 2 HOLE FLANGE TO BNC MALE SEE MOUNTING HOLE SECTION ON PAGE 369						
Formable Cable Assemblies						
PE-SR402FLJ Coax, 50 Ohm						
Part No. PE3C4919	Cable Dia.	Attn. @ 1 GHz	Power @ 1 GHz			
1 piece price shown. See web or call for volume pricing.						
6"	12"	24"	36"	60"	-	Custom Len.
\$83.84	\$87.50	\$94.83	\$102.16	\$116.83	-	See Web
BMA JACK 2 HOLE FLANGE TO N MALE SEE MOUNTING HOLE SECTION ON PAGE 369						
Formable Cable Assemblies						
PE-SR402FLJ Coax, 50 Ohm						
Part No. PE3C4913	Cable Dia.	Attn. @ 1 GHz	Power @ 1 GHz			
1 piece price shown. See web or call for volume pricing.						
6"	12"	24"	36"	60"	-	Custom Len.
\$76.42	\$80.09	\$87.42	\$94.75	\$109.41	-	See Web
PE-SR405FLJ Coax, 50 Ohm						
Part No. PE3C4861	Cable Dia.	Attn. @ 1 GHz	Power @ 1 GHz			
1 piece price shown. See web or call for volume pricing.						
6"	12"	24"	36"	60"	-	Custom Len.
\$88.11	\$91.88	\$99.40	\$106.92	\$121.98	-	See Web
Semi-Rigid Cable Assemblies						
RG405/U Coax, 50 Ohm						
Part No. PE3C4888	Cable Dia.	Attn. @ 1 GHz	Power @ 1 GHz			
1 piece price shown. See web or call for volume pricing.						
6"	12"	24"	36"	60"	-	Custom Len.
\$87.69	\$91.03	\$97.68	\$104.35	\$117.69	-	See Web
BMA JACK 2 HOLE FLANGE TO SMA MALE SEE MOUNTING HOLE SECTION ON PAGE 369						
Formable Cable Assemblies						
PE-SR402FLJ Coax, 50 Ohm						
Part No. PE3C4907	Cable Dia.	Attn. @ 1 GHz	Power @ 1 GHz			
1 piece price shown. See web or call for volume pricing.						
6"	12"	24"	36"	60"	-	Custom Len.
\$68.73	\$72.40	\$79.73	\$87.06	\$101.72	-	See Web
PE-SR405FLJ Coax, 50 Ohm						
Part No. PE3C4855	Cable Dia.	Attn. @ 1 GHz	Power @ 1 GHz			
1 piece price shown. See web or call for volume pricing.						
6"	12"	24"	36"	60"	-	Custom Len.
\$81.18	\$84.95	\$92.47	\$99.99	\$115.05	-	See Web
Semi-Rigid Cable Assemblies						
RG402/U Coax, 50 Ohm						
Part No. PE3W06981	Cable Dia.	Attn. @ 1 GHz	Power @ 1 GHz			
1 piece price shown. See web or call for volume pricing.						
12"	24"	36"	48"	60"	50CM	Custom Len.
\$91.59	\$99.18	\$106.78	\$114.37	\$121.97	\$96.45	See Web
RG405/U Coax, 50 Ohm						

Part No. PE3C4882				Cable Dia.	Attn. @ 1 GHz	Power @ 1 GHz
1 piece price shown. See web or call for volume pricing.						
6"	12"	24"	36"	* dia.	22 dB/100ft	130 W
\$80.76	\$84.10	\$90.79	\$97.42	\$110.76	-	Custom Len.
SEE WEB						
BMA JACK 2 HOLE FLANGE TO SMA MALE RIGHT ANGLE SEE MOUNTING HOLE SECTION ON PAGE 369						
Formable Cable Assemblies						
PE-SR402FLJ Coax, 50 Ohm						
Part No. PE3C4910	Cable Dia.	Attn. @ 1 GHz	Power @ 1 GHz			
1 piece price shown. See web or call for volume pricing.						
6"	12"	24"	36"	60"	-	Custom Len.
\$71.38	\$75.06	\$82.38	\$89.72	\$104.37	-	See Web
PE-SR405FLJ Coax, 50 Ohm						
Part No. PE3C4858	Cable Dia.	Attn. @ 1 GHz	Power @ 1 GHz			
1 piece price shown. See web or call for volume pricing.						
6"	12"	24"	36"	60"	-	Custom Len.
\$83.08	\$86.84	\$94.37	\$101.89	\$116.94	-	See Web
Semi-Rigid Cable Assemblies						
RG405/U Coax, 50 Ohm						
Part No. PE3C4885	Cable Dia.	Attn. @ 1 GHz	Power @ 1 GHz			
1 piece price shown. See web or call for volume pricing.						
6"	12"	24"	36"	60"	-	Custom Len.
\$82.65	\$85.99	\$92.65	\$99.32	\$112.66	-	See Web
BMA JACK 2 HOLE FLANGE TO SMP FEMALE SEE MOUNTING HOLE SECTION ON PAGE 369						
Formable Cable Assemblies						
PE-SR405FLJ Coax, 50 Ohm						
Part No. PE3C4867	Cable Dia.	Attn. @ 1 GHz	Power @ 1 GHz			
1 piece price shown. See web or call for volume pricing.						
6"	12"	24"	36"	60"	-	Custom Len.
\$89.77	\$93.53	\$101.06	\$108.59	\$123.63	-	See Web
Semi-Rigid Cable Assemblies						
RG405/U Coax, 50 Ohm						
Part No. PE3C4894	Cable Dia.	Attn. @ 1 GHz	Power @ 1 GHz			
1 piece price shown. See web or call for volume pricing.						
6"	12"	24"	36"	60"	-	Custom Len.
\$89.34	\$93.45	\$99.34	\$106.01	\$119.34	-	See Web
BMA JACK 2 HOLE FLANGE TO SMP FEMALE RIGHT ANGLE SEE MOUNTING HOLE SECTION ON PAGE 369						
Formable Cable Assemblies						
PE-SR405FLJ Coax, 50 Ohm						
Part No. PE3C4870	Cable Dia.	Attn. @ 1 GHz	Power @ 1 GHz			
1 piece price shown. See web or call for volume pricing.						
6"	12"	24"	36"	60"	-	Custom Len.
\$101.52	\$105.29	\$112.81	\$120.34	\$135.39	-	See Web
Semi-Rigid Cable Assemblies						
RG405/U Coax, 50 Ohm						
Part No. PE3C4897	Cable Dia.	Attn. @ 1 GHz	Power @ 1 GHz			
1 piece price shown. See web or call for volume pricing.						
6"	12"	24"	36"	60"	-	Custom Len.
\$101.11	\$104.44	\$111.09	\$117.76	\$131.10	-	See Web
BMA JACK 2 HOLE FLANGE TO TNC MALE SEE MOUNTING HOLE SECTION ON PAGE 369						
Formable Cable Assemblies						
PE-SR402FLJ Coax, 50 Ohm						
Part No. PE3C4916	Cable Dia.	Attn. @ 1 GHz	Power @ 1 GHz			
1 piece price shown. See web or call for volume pricing.						
6"	12"	24"	36"	60"	-	Custom Len.
\$73.26	\$76.93	\$84.25	\$91.59	\$106.25	-	See Web
PE-SR405FLJ Coax, 50 Ohm						
Part No. PE3C4864	Cable Dia.	Attn. @ 1 GHz	Power @ 1 GHz			
1 piece price shown. See web or call for volume pricing.						
6"	12"	24"	36"	60"	-	Custom Len.
\$84.95	\$88.72	\$96.24	\$103.76	\$118.81	-	See Web
Semi-Rigid Cable Assemblies						
RG405/U Coax, 50 Ohm						
Part No. PE3C4891	Cable Dia.	Attn. @ 1 GHz	Power @ 1 GHz			
1 piece price shown. See web or call for volume pricing.						
6"	12"	24"	36"	60"	-	Custom Len.
\$84.52	\$87.86	\$94.52	\$101.19	\$114.53	-	See Web

*Coax Performance at 1 GHz Notes: Cable assembly max frequency may be lower than connector or coax max frequency

For our complete selection of cable assemblies, please visit our website

BMA JACK RIGHT ANGLE 2 HOLE FLANGE TO BMA JACK RIGHT ANGLE 2
SEE MOUNTING HOLE SECTION ON PAGE 369



Formable Cable Assemblies

PE-SR402FLJ Coax, 50 Ohm

Part No. PE3C4902	Cable Dia.	Attn. @ 1 GHz	Power @ 1 GHz
1 piece price shown. See web or call for volume pricing.	0.161" dia.	12 dB/100ft	303 W
6" 12" 24" 36"	60"	-	Custom Len.
\$156.64 \$160.31 \$135.16 \$174.97	\$189.63	-	See Web

84

PE-SR405FLJ Coax, 50 Ohm

Part No. PE3C4849	Cable Dia.	Attn. @ 1 GHz	Power @ 1 GHz
1 piece price shown. See web or call for volume pricing.	0.105" dia.	20 dB/100ft	122 W
6" 12" 24" 36"	60"	-	Custom Len.
\$145.61 \$149.38 \$156.90 \$164.42	\$179.48	-	See Web

85

Flexible Cable Assemblies

RG400/U Coax, 50 Ohm

Part No. PE3C4952	Cable Dia.	Attn. @ 1 GHz	Power @ 1 GHz
1 piece price shown. See web or call for volume pricing.	0.195" dia.	15 dB/100ft	600 W
6" 12" 24" 36"	60"	-	Custom Len.
\$128.80 \$132.19 \$138.96 \$145.72	\$159.25	-	See Web

86

Semi-Rigid Cable Assemblies

RG405/U Coax, 50 Ohm

Part No. PE3C4876	Cable Dia.	Attn. @ 1 GHz	Power @ 1 GHz
1 piece price shown. See web or call for volume pricing.	.7" dia.	22 dB/100ft	130 W
6" 12" 24" 36"	60"	-	Custom Len.
\$145.19 \$148.53 \$155.17 \$161.85	\$175.19	-	See Web

87

BNC MALE TO BNC MALE



Standard Flexible Cable Assemblies

M17/60-RG142-27478 Coax, 50 Ohm

Part No. PE3M0001	Cable Dia.	Attn. @ 1 GHz	Power @ 1 GHz
1 piece price shown. See web or call for volume pricing.	0.195" dia.	dB/100ft	W
12" 18" 24" 30"	36" 48"	Custom Len.	
\$127.95 \$130.68 \$133.41 \$136.13	\$138.86 \$144.32	See Web	

88

M17/84-RG223-0XDS2 Coax, 50 Ohm

Part No. PE3M0029	Cable Dia.	Attn. @ 1 GHz	Power @ 1 GHz
1 piece price shown. See web or call for volume pricing.	0.212" dia.	dB/100ft	W
12" 18" 24" 30"	36" 48"	Custom Len.	
\$132.25 \$137.13 \$142.01 \$146.88	\$151.77 \$161.52	See Web	

89

M17/128-RG400-27478 Coax, 50 Ohm

Part No. PE3M0057	Cable Dia.	Attn. @ 1 GHz	Power @ 1 GHz
1 piece price shown. See web or call for volume pricing.	0.195" dia.	dB/100ft	W
12" 18" 24" 30"	36" 48"	Custom Len.	
\$129.44 \$132.91 \$136.38 \$139.85	\$143.32 \$150.26	See Web	

90

M17/113-RG316-27478 Coax, 50 Ohm

Part No. PE3M0085	Cable Dia.	Attn. @ 1 GHz	Power @ 1 GHz
1 piece price shown. See web or call for volume pricing.	0.098" dia.	dB/100ft	W
6" 8" 12" 16"	18" 24"	Custom Len.	
\$184.05 \$184.38 \$185.06 \$185.71	\$186.05 \$187.06	See Web	

91

M17/119-RG174-0XDS2 Coax, 50 Ohm

Part No. PE3M0100	Cable Dia.	Attn. @ 1 GHz	Power @ 1 GHz
1 piece price shown. See web or call for volume pricing.	0.110" dia.	dB/100ft	W
6" 8" 12" 16"	18" 24"	Custom Len.	
\$183.44 \$183.56 \$183.83 \$184.08	\$184.21 \$184.61	See Web	

92

M17/28-RG058-0XDS2 Coax, 50 Ohm

Part No. PE3M0115	Cable Dia.	Attn. @ 1 GHz	Power @ 1 GHz
1 piece price shown. See web or call for volume pricing.	0.195" dia.	dB/100ft	W
12" 18" 24" 30"	36" 48"	Custom Len.	
\$129.35 \$129.94 \$130.54 \$131.13	\$131.73 \$132.93	See Web	

93

BNC MALE TO N MALE



Standard Flexible Cable Assemblies

M17/60-RG142-27478 Coax, 50 Ohm

Part No. PE3M0002	Cable Dia.	Attn. @ 1 GHz	Power @ 1 GHz
1 piece price shown. See web or call for volume pricing.	0.195" dia.	dB/100ft	W
12" 18" 24" 30"	36" 48"	Custom Len.	
\$139.96 \$142.69 \$145.42 \$148.14	\$151.21 \$156.33	See Web	

94

M17/84-RG223-0XDS2 Coax, 50 Ohm

Part No. PE3M0030	Cable Dia.	Attn. @ 1 GHz	Power @ 1 GHz
1 piece price shown. See web or call for volume pricing.	0.212" dia.	dB/100ft	W
12" 18" 24" 30"	36" 48"	Custom Len.	
\$144.27 \$149.14 \$154.02 \$158.89	\$163.78 \$173.53	See Web	

95

M17/128-RG400-27478 Coax, 50 Ohm

Part No. PE3M0058	Cable Dia.	Attn. @ 1 GHz	Power @ 1 GHz
1 piece price shown. See web or call for volume pricing.	0.195" dia.	dB/100ft	W
12" 18" 24" 30"	36" 48"	Custom Len.	
\$141.45 \$144.92 \$148.39 \$151.86	\$155.33 \$162.27	See Web	

96

BNC MALE TO N FEMALE



Standard Flexible Cable Assemblies

M17/60-RG142-27478 Coax, 50 Ohm

Part No. PE3M0003	Cable Dia.	Attn. @ 1 GHz	Power @ 1 GHz
1 piece price shown. See web or call for volume pricing.	0.195" dia.	dB/100ft	W
12" 18" 24" 30"	36" 48"	Custom Len.	
\$149.54 \$152.27 \$155.00 \$157.72	\$160.45 \$165.91	See Web	

97

M17/84-RG223-0XDS2 Coax, 50 Ohm

Part No. PE3M0031	Cable Dia.	Attn. @ 1 GHz	Power @ 1 GHz
1 piece price shown. See web or call for volume pricing.	0.212" dia.	dB/100ft	W
12" 18" 24" 30"	36" 48"	Custom Len.	
\$153.84 \$158.72 \$163.60 \$168.47	\$173.36 \$183.11	See Web	

98

M17/128-RG400-27478 Coax, 50 Ohm

Part No. PE3M0059	Cable Dia.	Attn. @ 1 GHz	Power @ 1 GHz
1 piece price shown. See web or call for volume pricing.	0.195" dia.	dB/100ft	W
12" 18" 24" 30"	36" 48"	Custom Len.	
\$151.03 \$154.50 \$157.97 \$161.44	\$164.91 \$171.85	See Web	

99

BNC MALE TO N FEMALE BULKHEAD



SEE MOUNTING HOLE SECTION ON PAGE 369

Standard Flexible Cable Assemblies

M17/60-RG142-27478 Coax, 50 Ohm

Part No. PE3M0004	Cable Dia.	Attn. @ 1 GHz	Power @ 1 GHz
1 piece price shown. See web or call for volume pricing.	0.195" dia.	dB/100ft	W
12" 18" 24" 30"	36" 48"	Custom Len.	
\$153.39 \$156.11 \$158.84 \$161.56	\$164.30 \$169.75	See Web	

1

M17/84-RG223-0XDS2 Coax, 50 Ohm

Part No. PE3M0032	Cable Dia.	Attn. @ 1 GHz	Power @ 1 GHz
1 piece price shown. See web or call for volume pricing.	0.212" dia.	dB/100ft	W
12" 18" 24" 30"	36" 48"	Custom Len.	
\$157.69 \$162.56 \$167.45 \$172.32	\$177.20 \$186.96	See Web	

2

M17/128-RG400-27478 Coax, 50 Ohm

Part No. PE3M0060	Cable Dia.	Attn. @ 1 GHz	Power @ 1 GHz
1 piece price shown. See web or call for volume pricing.	0.195" dia.	dB/100ft	W
12" 18" 24" 30"	36" 48"	Custom Len.	
\$154.87 \$158.34 \$161.81 \$165.28	\$168.75 \$175.69	See Web	

3

BNC MALE TO SMA MALE



Standard Flexible Cable Assemblies

M17/60-RG142-27478 Coax, 50 Ohm

Part No. PE3M0005	Cable Dia.	Attn. @ 1 GHz	Power @ 1 GHz
1 piece price shown. See web or call for volume pricing.	0.195" dia.	dB/100ft	W
12" 18" 24" 30"	36" 48"	Custom Len.	
\$173.28 \$176.01 \$178.74 \$181.46	\$184.19 \$189.65	See Web	

4

M17/84-RG223-0XDS2 Coax, 50 Ohm

Part No. PE3M0033	Cable Dia.	Attn. @ 1 GHz	Power @ 1 GHz
1 piece price shown. See web or call for volume pricing.	0.212" dia.	dB/100ft	W
12" 18" 24" 30"	36" 48"	Custom Len.	
\$177.59 \$182.46 \$187.34 \$192.22	\$197.10 \$206.85	See Web	

5

M17/128-RG400-27478 Coax, 50 Ohm

Part No. PE3M0061	Cable Dia.	Attn. @ 1 GHz	Power @ 1 GHz
1 piece price shown. See web or call for volume pricing.	0.195" dia.	dB/100ft	W
12" 18" 24" 30"	36" 48"	Custom Len.	
\$174.77 \$178.24 \$181.71 \$185.18	\$188.65 \$195.59	See Web	

6

M17/113-RG316-27478 Coax, 50 Ohm

Part No. PE3M0086	Cable Dia.	Attn. @ 1 GHz	Power @ 1 GHz
1 piece price shown. See web or call for volume pricing.	0.098" dia.	dB/100ft	W
6" 8" 12" 16"	18" 24"	Custom Len.	
\$178.61 \$178.94 \$179.61 \$180.28	\$180.62 \$181.62	See Web	

7

M17/119-RG174-0XDS2 Coax, 50 Ohm

Part No. PE3M0101	Cable Dia.	Attn. @ 1 GHz	Power @ 1 GHz
1 piece price shown. See web or call for volume pricing.	0.110" dia.	dB/100ft	W
6" 8" 12" 16"	18" 24"	Custom Len.	
\$178.00 \$178.13 \$178.39 \$178.64	\$178.78 \$179.17	See Web	

8

M17/28-RG058-0XDS2 Coax, 50 Ohm

Part No. PE3M0116	Cable Dia.	Attn. @ 1 GHz	Power @ 1 GHz
1 piece price shown. See web or call for volume pricing.	0.195" dia.	dB/100ft	W
12" 18" 24" 30"	36" 48"	Custom Len.	
\$226.23 \$226.82 \$227.43 \$228.02	\$228.62 \$229.82	See Web	

9

BNC MALE TO SMA MALE RIGHT ANGLE



Standard Flexible Cable Assemblies

M17/60-RG142-27478 Coax, 50 Ohm

Part No. PE3M0003	Cable Dia.	Attn. @ 1 GHz	Power @ 1 GHz
1 piece price shown. See web or call for volume pricing.	0.195" dia.	dB/100ft	W
12" 18" 24" 30"	36" 48"	Custom Len.	
\$149.54 \$152.27 \$155.00 \$157.72	\$160.45 \$165.91	See Web	

97

Cable Assemblies

See Our Website For Current Pricing & Real-Time Stock Availability!

Continued on Next Page

For Custom Lengths, Metric Lengths or Special Configurations, Please call (949) 261-1920

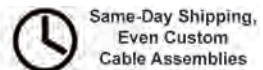
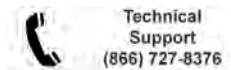

For our complete selection of cable assemblies, please visit our website

Cable Assemblies

See Our Website For Current Pricing & Real-Time Stock Availability!

Part No.	Cable Dia.				Attn. @ 1 GHz	Power @ 1 GHz
PE3M0006	0.195" dia.				dB/100ft	W
1 piece price shown. See web or call for volume pricing.	12"	18"	24"	30"	36"	48"
\$209.37	\$212.09	\$214.82	\$217.55	\$220.28	\$225.73	See Web
M17/84-RG223-0XDS2 Coax, 50 Ohm						
PE3M0034	0.212" dia.				dB/100ft	W
1 piece price shown. See web or call for volume pricing.	12"	18"	24"	30"	36"	48"
\$213.67	\$218.54	\$223.43	\$228.30	\$233.18	\$242.94	See Web
M17/128-RG400-27478 Coax, 50 Ohm						
PE3M0062	0.195" dia.				dB/100ft	W
1 piece price shown. See web or call for volume pricing.	12"	18"	24"	30"	36"	48"
\$210.85	\$214.31	\$217.80	\$221.26	\$224.74	\$231.68	See Web
M17/113-RG316-27478 Coax, 50 Ohm						
PE3M0087	0.098" dia.				dB/100ft	W
1 piece price shown. See web or call for volume pricing.	6"	8"	12"	16"	18"	24"
\$194.47	\$194.80	\$195.48	\$196.13	\$196.47	\$197.48	See Web
M17/119-RG174-0XDS2 Coax, 50 Ohm						
PE3M0102	0.110" dia.				dB/100ft	W
1 piece price shown. See web or call for volume pricing.	6"	8"	12"	16"	18"	24"
\$193.86	\$193.98	\$194.25	\$194.50	\$194.64	\$195.05	See Web
M17/28-RG058-0XDS2 Coax, 50 Ohm						
PE3M0117	0.195" dia.				dB/100ft	W
1 piece price shown. See web or call for volume pricing.	12"	18"	24"	30"	36"	48"
\$165.56	\$166.16	\$166.76	\$167.35	\$167.95	\$169.15	See Web

BNC MALE TO SMA FEMALE BULKHEAD

SEE MOUNTING HOLE SECTION ON PAGE 369



Standard Flexible Cable Assemblies

M17/113-RG316-27478 Coax, 50 Ohm

Part No.	Cable Dia.				Attn. @ 1 GHz	Power @ 1 GHz
PE3M0088	0.098" dia.				dB/100ft	W
1 piece price shown. See web or call for volume pricing.	6"	8"	12"	16"	18"	24"
\$185.23	\$185.56	\$186.23	\$186.90	\$187.24	\$188.24	See Web
M17/119-RG174-0XDS2 Coax, 50 Ohm						
PE3M0103	0.110" dia.				dB/100ft	W
1 piece price shown. See web or call for volume pricing.	6"	8"	12"	16"	18"	24"
\$184.62	\$184.74	\$185.00	\$185.26	\$185.40	\$185.78	See Web

BNC MALE TO TNC MALE



Standard Flexible Cable Assemblies

M17/60-RG142-27478 Coax, 50 Ohm

Part No.	Cable Dia.				Attn. @ 1 GHz	Power @ 1 GHz
PE3M0007	0.195" dia.				dB/100ft	W
1 piece price shown. See web or call for volume pricing.	12"	18"	24"	30"	36"	48"
\$142.57	\$145.29	\$148.19	\$150.75	\$153.48	\$158.94	See Web
M17/84-RG223-0XDS2 Coax, 50 Ohm						
PE3M0035	0.212" dia.				dB/100ft	W
1 piece price shown. See web or call for volume pricing.	12"	18"	24"	30"	36"	48"
\$146.87	\$151.75	\$156.63	\$161.50	\$166.39	\$176.14	See Web
M17/128-RG400-27478 Coax, 50 Ohm						
PE3M0063	0.195" dia.				dB/100ft	W
1 piece price shown. See web or call for volume pricing.	12"	18"	24"	30"	36"	48"
\$144.06	\$147.53	\$151.00	\$154.47	\$157.94	\$164.88	See Web
M17/113-RG316-27478 Coax, 50 Ohm						
PE3M0089	0.098" dia.				dB/100ft	W
1 piece price shown. See web or call for volume pricing.	6"	8"	12"	16"	18"	24"
\$186.19	\$186.52	\$187.20	\$187.85	\$188.19	\$189.20	See Web
M17/119-RG174-0XDS2 Coax, 50 Ohm						
PE3M0104	0.110" dia.				dB/100ft	W
1 piece price shown. See web or call for volume pricing.	6"	8"	12"	16"	18"	24"
\$185.58	\$185.74	\$185.97	\$186.22	\$186.36	\$186.75	See Web
M17/28-RG058-0XDS2 Coax, 50 Ohm						
PE3M0118	0.195" dia.				dB/100ft	W
1 piece price shown. See web or call for volume pricing.	12"	18"	24"	30"	36"	48"
\$194.64	\$195.23	\$195.83	\$196.42	\$197.03	\$198.22	See Web

BNC MALE TO BNC MALE



Flexible Cable Assemblies

PE-P195 Coax, 50 Ohm						
PE34035	0.195" dia.				Attn. @ 1 GHz	Power @ 1 GHz
1 piece price shown. See web or call for volume pricing.	12"	24"	36"	48"	60"	13 dB/100ft
\$24.42	\$34.00	\$43.58	\$53.71	\$63.47	-	Custom Len.
LMR-195 Coax, 50 Ohm						
PE3C0054	0.195" dia.				Attn. @ 1 GHz	Power @ 1 GHz
1 piece price shown. See web or call for volume pricing.	12"	24"	36"	48"	60"	12 dB/100ft
\$24.00	\$24.72	\$25.45	\$26.21	\$26.94	-	Custom Len.
Low Loss Flexible Cable Assemblies						
PE-C195 Coax, 50 Ohm						
PE36066	0.195" dia.				Attn. @ 1 GHz	Power @ 1 GHz
1 piece price shown. See web or call for volume pricing.	12"	24"	36"	48"	60"	11 dB/100ft
\$28.23	\$29.01	\$29.80	\$30.62	\$31.42	-	150 W
PE-C200 Coax, 50 Ohm						
PE35256	0.195" dia.				Attn. @ 1 GHz	Power @ 1 GHz
1 piece price shown. See web or call for volume pricing.	12"	24"	36"	48"	60"	11 dB/100ft
\$46.09	\$48.52	\$50.53	\$56.99	\$61.19	-	170 W
PE-C240 Coax, 50 Ohm						
PE36219	0.240" dia.				Attn. @ 1 GHz	Power @ 1 GHz
1 piece price shown. See web or call for volume pricing.	12"	24"	36"	48"	60"	9 dB/100ft
\$53.39	\$59.87	\$61.00	\$57.82	\$63.36	-	250 W
PE-C300 Coax, 50 Ohm						
PE35729	0.300" dia.				Attn. @ 1 GHz	Power @ 1 GHz
1 piece price shown. See web or call for volume pricing.	12"	24"	36"	48"	60"	6 dB/100ft
\$51.88	\$54.71	\$57.55	\$60.38	\$68.35	-	350 W
PE-C400 Coax, 50 Ohm						
PE35874	0.400" dia.				Attn. @ 1 GHz	Power @ 1 GHz
1 piece price shown. See web or call for volume pricing.	12"	24"	36"	48"	60"	4 dB/100ft
\$83.68	\$85.00	\$88.54	\$93.35	\$98.15	-	550 W
LMR-240 Coax, 50 Ohm						
PE3W01041	0.240" dia.				Attn. @ 1 GHz	Power @ 1 GHz
1 piece price shown. See web or call for volume pricing.	12"	24"	36"	48"	60"	50CM
\$52.39	\$53.32	\$54.27	\$55.21	\$56.15	\$52.99	Custom Len.
LMR-400-DB Coax, 50 Ohm						
PE3W01357	0.405" dia.				Attn. @ 1 GHz	Power @ 1 GHz
1 piece price shown. See web or call for volume pricing.	12"	24"	36"	48"	60"	4 dB/100ft
\$54.13	\$59.71	\$61.04	\$62.37	\$63.70	\$59.23	50CM
PE-SF200LL Coax, 50 Ohm						
PE3TC1100	0.185" dia.				Attn. @ 1 GHz	Power @ 1 GHz
1 piece price shown. See web or call for volume pricing.	24"	36"	48"	72"	100CM	200CM
\$68.40	\$79.65	\$90.91	\$113.44	\$82.82	\$119.76	Custom Len.
LMR-200-UF Coax, 50 Ohm						
PE3C2220	* dia.				Attn. @ 1 GHz	Power @ 1 GHz
1 piece price shown. See web or call for volume pricing.	12"	24"	36"	48"	60"	50CM
\$45.51	\$47.68	\$49.85	\$52.02	\$54.19	\$46.89	Custom Len.
Standard Formable Cable Assemblies						
PE-SR401FL Coax, 50 Ohm						
PE34166	* dia.				Attn. @ 1 GHz	Power @ 1 GHz
1 piece price shown. See web or call for volume pricing.	6"	12"	18"	24"	36"	8 dB/100ft
\$129.00	\$136.49	\$143.94	\$151.44	\$166.39	\$181.33	1400 W
PE-SR402FL Coax, 50 Ohm						
PE3462	* dia.				Attn. @ 1 GHz	Power @ 1 GHz
1 piece price shown. See web or call for volume pricing.	6"	12"	18"	24"	36"	12 dB/100ft
\$86.70	\$90.62	\$94.66	\$98.71	\$98.98	\$115.33	450 W
PE-SR405FL Coax, 50 Ohm						
PE3776	* dia.				Attn. @ 1 GHz	Power @ 1 GHz
1 piece price shown. See web or call for volume pricing.	6"	12"	18"	24"	36"	23 dB/100ft
\$85.59	\$92.44	\$90.93	\$96.28	\$115.13	\$117.67	130 W
Standard Flexible Cable Assemblies						
RG8A/U Coax, 50 Ohm						
PE3807	0.405" dia.				Attn. @ 1 GHz	Power @ 1 GHz
1 piece price shown. See web or call for volume pricing.	12"	24"	36"	48"	60"	8 dB/100ft
\$77.00	\$79.84	\$87.76	\$85.50	\$88.34	\$97.27	190 W
RG8X Coax, 50 Ohm						
PE3264	0.242" dia.				Attn. @ 1 GHz	Power @ 1 GHz
1 piece price shown. See web or call for volume pricing.	12"	24"	36"	48"	60"	14 dB/100ft
\$65.25	\$74.00	\$77.53	\$74.41	\$84.87	-	60 W
RG58C/U Coax, 50 Ohm						

*Coax Performance at 1 GHz Notes: Cable assembly max frequency may be lower than connector or coax max frequency

For our complete selection of cable assemblies, please visit our website

Part No.	Cable Dia.				Attn. @ 1 GHz	Power @ 1 GHz
Part No. PE3067	1 piece price shown. See web or call for volume pricing.				0.195" dia.	20 dB/100ft 44 W
12"	18"	24"	30"	36"	48"	Custom Len.
\$31.20	\$31.56	\$31.93	\$33.67	\$32.66	\$33.39	See Web
RG58-P Coax, 50 Ohm						
Part No. PE3999	1 piece price shown. See web or call for volume pricing.				0.159" dia.	17 dB/100ft 632 W
12"	24"	36"	48"	60"	-	Custom Len.
\$47.34	\$52.34	\$64.28	\$62.33	\$67.33	-	See Web
RG141A/U Coax, 50 Ohm						
Part No. PE35148	1 piece price shown. See web or call for volume pricing.				0.190" dia.	13 dB/100ft 650 W
12"	24"	36"	48"	60"	-	Custom Len.
\$46.65	\$53.55	\$60.45	\$67.75	\$74.80	-	See Web
RG142B/U Coax, 50 Ohm						
Part No. PE3495	1 piece price shown. See web or call for volume pricing.				0.195" dia.	dB/100ft 650 W
12"	24"	36"	48"	60"	72"	Custom Len.
\$31.53	\$37.61	\$43.70	\$50.13	\$56.32	\$62.52	See Web
RG174A/U Coax, 50 Ohm						
Part No. PE3C2295	1 piece price shown. See web or call for volume pricing.				0.110" dia.	32 dB/100ft 17 W
12"	24"	36"	48"	60"	72"	Custom Len.
\$30.29	\$30.87	\$31.44	\$32.05	\$32.65	\$33.23	See Web
RG178B/U Coax, 50 Ohm						
Part No. PE33130	1 piece price shown. See web or call for volume pricing.				0.072" dia.	44 dB/100ft 55 W
12"	24"	36"	48"	60"	-	Custom Len.
\$65.18	\$66.24	\$67.30	\$68.42	\$69.50	-	See Web
RG188A/U Coax, 50 Ohm						
Part No. PE3C2034	1 piece price shown. See web or call for volume pricing.				0.110" dia.	26 dB/100ft 160 W
12"	24"	36"	48"	60"	72"	Custom Len.
\$35.94	\$38.43	\$40.93	\$43.57	\$46.10	\$48.65	See Web
RG213/U Coax, 50 Ohm						
Part No. PE3749	1 piece price shown. See web or call for volume pricing.				0.405" dia.	8 dB/100ft 190 W
12"	24"	36"	48"	60"	72"	Custom Len.
\$77.29	\$78.96	\$83.96	\$82.29	\$83.94	\$85.61	See Web
RG214/U Coax, 50 Ohm						
Part No. PE3906	1 piece price shown. See web or call for volume pricing.				0.425" dia.	7 dB/100ft 190 W
12"	24"	36"	48"	60"	72"	Custom Len.
\$76.57	\$90.48	\$98.26	\$106.50	\$105.87	\$113.20	See Web
RG223/U Coax, 50 Ohm						
Part No. PE3087	1 piece price shown. See web or call for volume pricing.				0.209" dia.	13 dB/100ft 50 W
12"	24"	36"	48"	60"	72"	Custom Len.
\$30.00	\$32.89	\$35.79	\$38.70	\$41.59	\$44.49	See Web
RG303/U Coax, 50 Ohm						
Part No. PE3W00393	1 piece price shown. See web or call for volume pricing.				0.170" dia.	14 dB/100ft 650 W
12"	24"	36"	48"	60"	50CM	Custom Len.
\$34.88	\$41.76	\$48.64	\$55.51	\$62.39	\$39.28	See Web
RG316/U Coax, 50 Ohm						
Part No. PE3C2416	1 piece price shown. See web or call for volume pricing.				0.102" dia.	38 dB/100ft 160 W
12"	24"	36"	48"	60"	72"	Custom Len.
\$34.45	\$37.57	\$40.70	\$44.00	\$47.19	\$50.38	See Web
RG400/U Coax, 50 Ohm						
Part No. PE3582	1 piece price shown. See web or call for volume pricing.				0.195" dia.	15 dB/100ft 650 W
12"	24"	36"	48"	60"	72"	Custom Len.
\$41.98	\$49.37	\$56.77	\$64.59	\$72.14	\$79.67	See Web
Standard Semi-Rigid Cable Assemblies						
PE-047SR Coax, 50 Ohm						
Part No. PE34177	1 piece price shown. See web or call for volume pricing.				" dia.	40 dB/100ft 32 W
6"	12"	18"	24"	36"	48"	Custom Len.
\$99.14	\$99.14	\$104.26	\$109.38	\$119.62	\$129.84	See Web
PE-SR402AL Coax, 50 Ohm						
Part No. PE34164	1 piece price shown. See web or call for volume pricing.				0.141" dia.	13 dB/100ft 450 W
6"	12"	18"	24"	36"	48"	Custom Len.
\$74.92	\$84.25	\$84.04	\$88.61	\$97.73	\$106.85	See Web
PE-SR405AL Coax, 50 Ohm						
Part No. PE34162	1 piece price shown. See web or call for volume pricing.				" dia.	23 dB/100ft 130 W
6"	12"	18"	24"	36"	48"	Custom Len.
\$74.57	\$78.70	\$82.90	\$87.09	\$95.45	\$103.85	See Web
RG401/U Coax, 50 Ohm						
Part No. PE34170	1 piece price shown. See web or call for volume pricing.				" dia.	8 dB/100ft 870 W
6"	12"	18"	24"	36"	48"	Custom Len.
\$132.18	\$142.86	\$153.49	\$164.10	\$185.41	\$226.47	See Web

Part No.	Cable Dia.				Attn. @ 1 GHz	Power @ 1 GHz
Part No. PE3445	1 piece price shown. See web or call for volume pricing.				" dia.	12 dB/100ft 650 W
6"	12"	18"	24"	36"	48"	Custom Len.
\$82.09	\$87.02	\$85.74	\$89.39	\$102.66	\$104.00	See Web
RG405/U Coax, 50 Ohm						
Part No. PE3678	1 piece price shown. See web or call for volume pricing.				" dia.	22 dB/100ft 130 W
6"	12"	18"	24"	36"	48"	Custom Len.
\$73.65	\$77.01	\$85.34	\$83.68	\$90.30	\$96.96	See Web
PE-SR401AL-STRAIGHT Coax, 50 Ohm						
Part No. PE34175	1 piece price shown. See web or call for volume pricing.				0.250" dia.	8 dB/100ft 1400 W
6"	12"	18"	24"	36"	48"	Custom Len.
\$130.31	\$139.13	\$147.90	\$156.71	\$174.31	\$191.89	See Web
Standard Flexible Cable Assemblies						
RG55B/U Coax, 53 Ohm						
Part No. PE3583	1 piece price shown. See web or call for volume pricing.				0.202" dia.	17 dB/100ft 53 W
12"	24"	36"	48"	60"	72"	Custom Len.
\$32.15	\$34.73	\$37.33	\$40.06	\$42.71	\$45.35	See Web
RG59B/U Coax, 75 Ohm						
Part No. PE3075	1 piece price shown. See web or call for volume pricing.				0.242" dia.	12 dB/100ft 74 W
12"	18"	24"	30"	36"	48"	Custom Len.
\$26.67	\$27.99	\$27.63	\$28.12	\$28.58	\$29.55	See Web
RG179B/U Coax, 75 Ohm						
Part No. PE3C3349	1 piece price shown. See web or call for volume pricing.				0.100" dia.	29 dB/100ft 240 W
12"	24"	36"	48"	60"	72"	Custom Len.
\$37.35	\$36.96	\$39.32	\$41.67	\$44.04	\$50.39	See Web
RG302/U Coax, 75 Ohm						
Part No. PE33123	1 piece price shown. See web or call for volume pricing.				0.206" dia.	13 dB/100ft 650 W
12"	24"	36"	48"	60"	-	Custom Len.
\$30.75	\$36.62	\$42.47	\$48.34	\$54.22	-	See Web
RG62A/U Coax, 93 Ohm						
Part No. PE3081	1 piece price shown. See web or call for volume pricing.				0.239" dia.	9 dB/100ft 77 W
12"	24"	36"	48"	60"	72"	Custom Len.
\$32.18	\$36.29	\$37.83	\$39.46	\$41.04	\$42.61	See Web
RG180B/U Coax, 95 Ohm						
Part No. PE33574	1 piece price shown. See web or call for volume pricing.				0.145" dia.	dB/100ft 250 W
12"	24"	36"	48"	60"	-	Custom Len.
\$43.50	\$47.83	\$48.27	\$56.73	\$56.25	-	See Web
BNC MALE TO BNC MALE RIGHT ANGLE						
Low Loss Flexible Cable Assemblies						
PE-C240 Coax, 50 Ohm						
Part No. PE38997	1 piece price shown. See web or call for volume pricing.				0.240" dia.	9 dB/100ft 250 W
12"	24"	36"	48"	60"	-	Custom Len.
\$54.99	\$52.83	\$54.58	\$57.34	\$60.16	-	See Web
LMR-195 Coax, 50 Ohm						
Part No. PE3W01992	1 piece price shown. See web or call for volume pricing.				0.195" dia.	dB/100ft W
12"	24"	36"	48"	60"	50CM	Custom Len.
\$43.04	\$43.76	\$44.49	\$45.22	\$45.94	\$43.50	See Web
Standard Formable Cable Assemblies						
PE-SR402FL Coax, 50 Ohm						
Part No. PE35580	1 piece price shown. See web or call for volume pricing.				" dia.	12 dB/100ft 450 W
12"	24"	36"	48"	60"	-	Custom Len.
\$86.30	\$93.84	\$101.38	\$108.92	\$116.45	-	See Web
Standard Flexible Cable Assemblies						
RG58C/U Coax, 50 Ohm						
Part No. PE3020	1 piece price shown. See web or call for volume pricing.				0.195" dia.	20 dB/100ft 44 W
12"	24"	36"	48"	60"	72"	Custom Len.
\$51.34	\$52.15	\$52.97	\$53.82	\$54.65	\$55.48	See Web
RG142B/U Coax, 50 Ohm						
Part No. PE3082	1 piece price shown. See web or call for volume pricing.				0.195" dia.	13 dB/100ft W
12"	24"	36"	48"	60"	72"	Custom Len.
\$49.31	\$55.39	\$61.47	\$64.61	\$70.34	\$76.08	See Web
RG174A/U Coax, 50 Ohm						
Part No. PE3C3404	1 piece price shown. See web or call for volume pricing.				0.110" dia.	32 dB/100ft 17 W
12"	24"	36"	48"	60"	72"	Custom Len.
\$54.34	\$54.92	\$53.12	\$56.11	\$56.70	\$54.43	See Web

Cable Assemblies

See Our Website For Current Pricing & Real-Time Stock Availability!

For Custom Lengths, Metric Lengths or Special Configurations, Please call (949) 261-1920

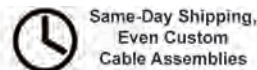
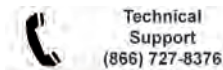

For our complete selection of cable assemblies, please visit our website

Cable Assemblies

See Our Website For Current Pricing & Real-Time Stock Availability!

RG188A/U Coax, 50 Ohm						
Part No. PE3C3377				Cable Dia.	Attn. @ 1 GHz	Power @ 1 GHz
1 piece price shown. See web or call for volume pricing.						
12"	24"	36"	48"	60"	72"	Custom Len.
\$65.31	\$67.81	\$70.30	\$67.13	\$69.35	\$78.02	See Web
RG213/U Coax, 50 Ohm						
Part No. PE3355				Cable Dia.	Attn. @ 1 GHz	Power @ 1 GHz
1 piece price shown. See web or call for volume pricing.						
12"	24"	36"	48"	60"	72"	Custom Len.
\$86.03	\$92.98	\$89.35	\$91.03	\$92.68	\$94.34	See Web
RG214/U Coax, 50 Ohm						
Part No. PE3325				Cable Dia.	Attn. @ 1 GHz	Power @ 1 GHz
1 piece price shown. See web or call for volume pricing.						
12"	24"	36"	48"	60"	72"	Custom Len.
\$89.41	\$91.73	\$99.10	\$106.50	\$113.86	\$121.26	See Web
RG223/U Coax, 50 Ohm						
Part No. PE3689				Cable Dia.	Attn. @ 1 GHz	Power @ 1 GHz
1 piece price shown. See web or call for volume pricing.						
12"	24"	36"	48"	60"	72"	Custom Len.
\$45.49	\$48.60	\$51.72	\$55.02	\$55.34	\$58.24	See Web
RG316/U Coax, 50 Ohm						
Part No. PE3C3391				Cable Dia.	Attn. @ 1 GHz	Power @ 1 GHz
1 piece price shown. See web or call for volume pricing.						
12"	24"	36"	48"	60"	72"	Custom Len.
\$62.26	\$61.63	\$64.52	\$67.41	\$75.01	\$78.18	See Web
RG400/U Coax, 50 Ohm						
Part No. PE3116				Cable Dia.	Attn. @ 1 GHz	Power @ 1 GHz
1 piece price shown. See web or call for volume pricing.						
12"	24"	36"	48"	60"	72"	Custom Len.
\$65.72	\$73.11	\$80.50	\$88.34	\$89.87	\$103.41	See Web
RG59B/U Coax, 75 Ohm						
Part No. PE3508				Cable Dia.	Attn. @ 1 GHz	Power @ 1 GHz
1 piece price shown. See web or call for volume pricing.						
12"	24"	36"	48"	60"	72"	Custom Len.
\$48.54	\$45.04	\$50.62	\$46.84	\$47.74	\$53.83	See Web
RG179B/U Coax, 75 Ohm						
Part No. PE3C3375				Cable Dia.	Attn. @ 1 GHz	Power @ 1 GHz
1 piece price shown. See web or call for volume pricing.						
12"	24"	36"	48"	60"	72"	Custom Len.
\$60.73	\$63.09	\$71.92	\$67.83	\$70.18	\$72.55	See Web

BNC MALE TO BNC FEMALE



Low Loss Flexible Cable Assemblies

PE-C195 Coax, 50 Ohm

Part No. PE38344				Cable Dia.	Attn. @ 1 GHz	Power @ 1 GHz
1 piece price shown. See web or call for volume pricing.						
12"	24"	36"	48"	60"	72"	Custom Len.
\$28.28	\$29.00	\$29.72	\$30.43	\$31.14	-	See Web

PE-SF200LL Coax, 50 Ohm

Part No. PE3TC1101				Cable Dia.	Attn. @ 1 GHz	Power @ 1 GHz
1 piece price shown. See web or call for volume pricing.						
24"	36"	48"	72"	100CM	200CM	Custom Len.
\$68.40	\$79.65	\$90.91	\$113.44	\$82.82	\$119.76	See Web

Standard Flexible Cable Assemblies

RG8A/U Coax, 50 Ohm

Part No. PE3360				Cable Dia.	Attn. @ 1 GHz	Power @ 1 GHz
1 piece price shown. See web or call for volume pricing.						
12"	24"	36"	48"	60"	72"	Custom Len.
\$89.86	\$92.64	\$95.39	\$98.09	\$100.85	\$110.91	See Web

RG58C/U Coax, 50 Ohm

Part No. PE3047				Cable Dia.	Attn. @ 1 GHz	Power @ 1 GHz
1 piece price shown. See web or call for volume pricing.						
12"	24"	36"	48"	60"	72"	Custom Len.
\$38.58	\$39.39	\$40.21	\$41.07	\$41.89	\$42.72	See Web

RG142B/U Coax, 50 Ohm

Part No. PE3777				Cable Dia.	Attn. @ 1 GHz	Power @ 1 GHz
1 piece price shown. See web or call for volume pricing.						
12"	24"	36"	48"	60"	72"	Custom Len.
\$36.97	\$42.70	\$48.43	\$54.17	\$59.90	\$65.63	See Web

RG174A/U Coax, 50 Ohm

Part No. PE3C3325				Cable Dia.	Attn. @ 1 GHz	Power @ 1 GHz
1 piece price shown. See web or call for volume pricing.						
12"	24"	36"	48"	60"	72"	Custom Len.
\$41.61	\$42.18	\$40.27	\$43.38	\$43.96	\$43.96	See Web

RG188A/U Coax, 50 Ohm

Part No. PE3C3453				Cable Dia.	Attn. @ 1 GHz	Power @ 1 GHz
1 piece price shown. See web or call for volume pricing.						
12"	24"	36"	48"	60"	72"	Custom Len.
\$41.03	\$43.11	\$45.19	\$47.21	\$49.29	\$51.32	See Web

RG213/U Coax, 50 Ohm

Part No. PE3949				Cable Dia.	Attn. @ 1 GHz	Power @ 1 GHz
1 piece price shown. See web or call for volume pricing.						
12"	24"	36"	48"	60"	72"	Custom Len.
\$87.67	\$89.25	\$90.76	\$92.34	\$93.89	\$95.47	See Web

RG223/U Coax, 50 Ohm

Part No. PE3606				Cable Dia.	Attn. @ 1 GHz	Power @ 1 GHz
1 piece price shown. See web or call for volume pricing.						
12"	24"	36"	48"	60"	72"	Custom Len.
\$35.07	\$34.76	\$41.29	\$44.58	\$43.47	\$46.37	See Web

RG316/U Coax, 50 Ohm

Part No. PE3C3344				Cable Dia.	Attn. @ 1 GHz	Power @ 1 GHz
1 piece price shown. See web or call for volume pricing.						
12"	24"	36"	48"	60"	72"	Custom Len.
\$43.72	\$46.85	\$49.97	\$53.28	\$53.58	\$59.65	See Web

RG400/U Coax, 50 Ohm

Part No. PE3627				Cable Dia.	Attn. @ 1 GHz	Power @ 1 GHz
1 piece price shown. See web or call for volume pricing.						
12"	24"	36"	48"	60"	72"	Custom Len.
\$50.42	\$52.81	\$59.78	\$66.76	\$73.72	\$88.12	See Web

RG55B/U Coax, 53 Ohm

Part No. PE3375				Cable Dia.	Attn. @ 1 GHz	Power @ 1 GHz
1 piece price shown. See web or call for volume pricing.						
12"	24"	36"	48"	60"	72"	Custom Len.
\$33.28	\$35.51	\$37.76	\$40.00	\$42.24	\$44.48	See Web

RG59B/U Coax, 75 Ohm

Part No. PE3792				Cable Dia.	Attn. @ 1 GHz	Power @ 1 GHz
1 piece price shown. See web or call for volume pricing.						
12"	24"	36"	48"	60"	72"	Custom Len.
\$28.81	\$29.77	\$30.73	\$34.29	\$32.65	\$33.60	See Web

RG62A/U Coax, 93 Ohm

Part No. PE3368				Cable Dia.	Attn. @ 1 GHz	Power @ 1 GHz
1 piece price shown. See web or call for volume pricing.						
12"	24"	36"	48"	60"	72"	Custom Len.
\$27.09	\$28.41	\$29.74	\$31.05	\$32.38	\$33.69	See Web

BNC MALE TO BNC FEMALE BULKHEAD

SEE MOUNTING HOLE SECTION ON PAGE 369



Low Loss Flexible Cable Assemblies

PE-C195 Coax, 50 Ohm

Part No. PE38804				Cable Dia.	Attn. @ 1 GHz	Power @ 1 GHz
1 piece price shown. See web or call for volume pricing.						
12"	24"	36"	48"	60"	72"	Custom Len.
\$32.78	\$36.19	\$34.20	\$34.91	\$35.63	-	See Web

Standard Flexible Cable Assemblies

RG8A/U Coax, 50 Ohm

Part No. PE3440				Cable Dia.	Attn. @ 1 GHz	Power @ 1 GHz
1 piece price shown. See web or call for volume pricing.						
12"	24"	36"	48"	60"	72"	Custom Len.
\$93.88	\$96.65	\$99.40	\$102.10	\$104.87	\$107.57	See Web

RG58C/U Coax, 50 Ohm

Part No. PE3649				Cable Dia.	Attn. @ 1 GHz	Power @ 1 GHz
1 piece price shown. See web or call for volume pricing.						
12"	24"	36"	48"	60"	72"	Custom Len.
\$44.48	\$45.29	\$46.11	\$46.97	\$47.79	\$48.63	See Web

RG142B/U Coax, 50 Ohm

Part No. PE3436				Cable Dia.	Attn. @ 1 GHz	Power @ 1 GHz
1 piece price shown. See web or call for volume pricing.						
12"	24"	36"	48"	60"	72"	Custom Len.
\$50.01	\$51.19	\$56.92	\$62.66	\$68.39	\$74.12	See Web

RG174A/U Coax, 50 Ohm

Part No. PE3C3397				Cable Dia.	Attn. @ 1 GHz	Power @ 1 GHz
1 piece price shown. See web or call for volume pricing.						
12"	24"	36"	48"	60"	72"	Custom Len.
\$47.18	\$47.76	\$48.34	\$45.00	\$45.44	\$45.86	See Web

RG223/U Coax, 50 Ohm

Part No. PE3557				Cable Dia.	Attn. @ 1 GHz	Power @ 1 GHz
1 piece price shown. See web or call for volume pricing.						
12"	24"	36"	48"	60"	72"	Custom Len.
\$43.40	\$46.30	\$49.19	\$56.40	\$59.57	\$57.89	See Web

RG316/U Coax, 50 Ohm

Part No. PE3C3446				Cable Dia.	Attn. @ 1 GHz	Power @ 1 GHz
1 piece price shown. See web or call for volume pricing.						
12"	24"	36"	48"	60"	72"	Custom Len.
\$43.26	\$46.38	\$49.51	\$51.61	\$54.50	\$57.37	See Web

RG400/U Coax, 50 Ohm

Part No. PE3423				Cable Dia.	Attn. @ 1 GHz	Power @ 1 GHz
1 piece price shown. See web or call for volume pricing.						
12"	24"	36"	48"	60"	72"	Custom Len.
\$57.78	\$65.18	\$72.56	\$80.40	\$87.93	\$88.35	See Web

RG59B/U Coax, 75 Ohm

Part No. PE3103				Cable Dia.	Attn. @ 1 GHz	Power @ 1 GHz
1 piece price shown. See web or call for volume pricing.						
12"	24"	36"	48"	60"	72"	Custom Len.
\$41.55	\$42.51	\$43.46	\$44.43	\$45.39	\$50.99	See Web

*Coax Performance at 1 GHz Notes: Cable assembly max frequency may be lower than connector or coax max frequency

For our complete selection of cable assemblies, please visit our website

BNC MALE TO MHV MALE



Standard Flexible Cable Assemblies

RG58C/U Coax, 50 Ohm

Part No. PE3W00032	Cable Dia.	Attn. @ 1 GHz	Power @ 1 GHz
1 piece price shown. See web or call for volume pricing.	0.195" dia.	dB/100ft	44 W
12" 24" 36" 48"	60"	50CM	Custom Len.
\$44.30 \$45.95 \$46.82 \$47.68	\$48.54	\$45.64	See Web

4

BNC MALE TO N MALE



Flexible Cable Assemblies

LMR-240 Coax, 50 Ohm

Part No. PE3W05881	Cable Dia.	Attn. @ 1 GHz	Power @ 1 GHz
1 piece price shown. See web or call for volume pricing.	0.240" dia.	8 dB/100ft	W
12" 24" 36" 48"	60"	50CM	Custom Len.
\$38.01 \$38.88 \$39.76 \$40.65	\$41.53	\$38.57	See Web

5

Standard Flexible Cable Assemblies

RG142B/U Coax, 50 Ohm

Part No. PE3061	Cable Dia.	Attn. @ 1 GHz	Power @ 1 GHz
1 piece price shown. See web or call for volume pricing.	0.195" dia.	13 dB/100ft	W
12" 24" 36" 48"	60"	72"	Custom Len.
\$44.54 \$50.62 \$56.70 \$63.13	\$64.17	\$69.90	See Web

6

Part No. PE3W06862	Cable Dia.	Attn. @ 1 GHz	Power @ 1 GHz
1 piece price shown. See web or call for volume pricing.	0.195" dia.	dB/100ft	W
12" 24" 36" 48"	60"	50CM	Custom Len.
\$39.43 \$45.32 \$51.22 \$57.12	\$63.03	\$43.20	See Web

7

BNC MALE TO SHV PLUG



Standard Flexible Cable Assemblies

RG58C/U Coax, 50 Ohm

Part No. PE3W00148	Cable Dia.	Attn. @ 1 GHz	Power @ 1 GHz
1 piece price shown. See web or call for volume pricing.	0.195" dia.	dB/100ft	44 W
12" 24" 36" 48"	60"	50CM	Custom Len.
\$59.77 \$60.55 \$61.33 \$62.11	\$62.89	\$60.27	See Web

8

BNC MALE TO SMA MALE



Standard Flexible Cable Assemblies

RG188A/U Coax, 50 Ohm

Part No. PE3W03670	Cable Dia.	Attn. @ 1 GHz	Power @ 1 GHz
1 piece price shown. See web or call for volume pricing.	0.110" dia.	26 dB/100ft	160 W
12" 24" 36" 48"	60"	50CM	Custom Len.
\$44.66 \$47.33 \$50.00 \$52.67	\$55.34	\$46.36	See Web

9

BNC MALE TO SSMC PLUG



Low Loss Flexible Cable Assemblies

LMR-100A-PVC Coax, 50 Ohm

Part No. PE3C4430	Cable Dia.	Attn. @ 1 GHz	Power @ 1 GHz
1 piece price shown. See web or call for volume pricing.	0.110" dia.	24 dB/100ft	W
6" 12" 18" 24"	36"	48"	Custom Len.
\$45.98 \$42.13 \$42.50 \$47.11	\$43.61	\$48.67	See Web

10

Standard Formable Cable Assemblies

PE-SR405FLJ Coax, 50 Ohm

Part No. PE3C4450	Cable Dia.	Attn. @ 1 GHz	Power @ 1 GHz
1 piece price shown. See web or call for volume pricing.	0.105" dia.	20 dB/100ft	122 W
6" 12" 18" 24"	36"	48"	Custom Len.
\$70.43 \$81.61 \$77.97 \$81.73	\$89.25	\$96.77	See Web

11

Standard Flexible Cable Assemblies

RG178B/U Coax, 50 Ohm

Part No. PE3C4397	Cable Dia.	Attn. @ 1 GHz	Power @ 1 GHz
1 piece price shown. See web or call for volume pricing.	0.072" dia.	44 dB/100ft	55 W
6" 12" 18" 24"	36"	48"	Custom Len.
\$68.62 \$69.09 \$69.55 \$70.02	\$78.12	\$79.24	See Web

12

RG316/U Coax, 50 Ohm

Part No. PE3C4413	Cable Dia.	Attn. @ 1 GHz	Power @ 1 GHz
1 piece price shown. See web or call for volume pricing.	0.098" dia.	58 dB/100ft	160 W
6" 12" 18" 24"	36"	48"	Custom Len.
\$52.34 \$53.75 \$55.15 \$56.54	\$63.22	\$62.15	See Web

13

BNC MALE TO SSMC PLUG RIGHT ANGLE



Low Loss Flexible Cable Assemblies

LMR-100A-PVC Coax, 50 Ohm

Part No. PE3C4431	Cable Dia.	Attn. @ 1 GHz	Power @ 1 GHz
1 piece price shown. See web or call for volume pricing.	0.110" dia.	24 dB/100ft	W
6" 12" 18" 24"	36"	48"	Custom Len.
\$42.20 \$38.70 \$39.07 \$39.43	\$40.17	\$40.91	See Web

14

Standard Flexible Cable Assemblies

RG178B/U Coax, 50 Ohm

Part No. PE3C4466	Cable Dia.	Attn. @ 1 GHz	Power @ 1 GHz
1 piece price shown. See web or call for volume pricing.	0.072" dia.	44 dB/100ft	55 W
6" 12" 18" 24"	36"	48"	Custom Len.
\$60.20 \$60.68 \$61.15 \$61.60	\$62.54	\$63.47	See Web

15

RG316/U Coax, 50 Ohm

Part No. PE3C4414	Cable Dia.	Attn. @ 1 GHz	Power @ 1 GHz
1 piece price shown. See web or call for volume pricing.	0.098" dia.	58 dB/100ft	160 W
6" 12" 18" 24"	36"	48"	Custom Len.
\$48.91 \$50.32 \$51.72 \$53.11	\$55.92	\$58.71	See Web

16

RG316-DS Coax, 50 Ohm

Part No. PE3C4476	Cable Dia.	Attn. @ 1 GHz	Power @ 1 GHz
1 piece price shown. See web or call for volume pricing.	0.114" dia.	9 dB/100ft	85 W
6" 12" 18" 24"	36"	48"	Custom Len.
\$53.80 \$50.29 \$51.70 \$53.11	\$55.93	\$64.88	See Web

17

BNC MALE RIGHT ANGLE TO BNC MALE RIGHT ANGLE



Standard Flexible Cable Assemblies

RG58C/U Coax, 50 Ohm

Part No. PE3025	Cable Dia.	Attn. @ 1 GHz	Power @ 1 GHz
1 piece price shown. See web or call for volume pricing.	0.195" dia.	20 dB/100ft	44 W
12" 24" 36" 48"	60"	72"	Custom Len.
\$70.27 \$71.08 \$71.90 \$72.76	\$73.58	\$74.41	See Web

18

RG142B/U Coax, 50 Ohm

Part No. PE3044	Cable Dia.	Attn. @ 1 GHz	Power @ 1 GHz
1 piece price shown. See web or call for volume pricing.	0.195" dia.	13 dB/100ft	W
12" 24" 36" 48"	60"	72"	Custom Len.
\$71.96 \$78.04 \$79.35 \$85.08	\$90.82	\$96.54	See Web

19

RG174A/U Coax, 50 Ohm

Part No. PE3373	Cable Dia.	Attn. @ 1 GHz	Power @ 1 GHz
1 piece price shown. See web or call for volume pricing.	0.100" dia.	32 dB/100ft	16 W
12" 24" 36" 48"	60"	72"	Custom Len.
\$83.33 \$77.60 \$78.03 \$78.47	\$78.90	\$79.33	See Web

20

RG188A/U Coax, 50 Ohm

Part No. PE3351	Cable Dia.	Attn. @ 1 GHz	Power @ 1 GHz
1 piece price shown. See web or call for volume pricing.	0.110" dia.	26 dB/100ft	160 W
12" 24" 36" 48"	60"	72"	Custom Len.
\$78.98 \$81.20 \$83.42 \$85.64	\$87.86	\$98.01	See Web

21

RG188-DS Coax, 50 Ohm

Part No. PE3381	Cable Dia.	Attn. @ 1 GHz	Power @ 1 GHz
1 piece price shown. See web or call for volume pricing.	0.122" dia.	30 dB/100ft	160 W
12" 24" 36" 48"	60"	72"	Custom Len.
\$74.27 \$77.56 \$80.87 \$84.16	\$87.40	\$90.70	See Web

22

RG213/U Coax, 50 Ohm

Part No. PE3384	Cable Dia.	Attn. @ 1 GHz	Power @ 1 GHz
1 piece price shown. See web or call for volume pricing.	0.405" dia.	8 dB/100ft	190 W
12" 24" 36" 48"	60"	72"	Custom Len.
\$96.77 \$98.45 \$100.13 \$101.80	\$103.43	\$105.11	See Web

23

RG214/U Coax, 50 Ohm

Part No. PE3370	Cable Dia.	Attn. @ 1 GHz	Power @ 1 GHz
1 piece price shown. See web or call for volume pricing.	0.425" dia.	7 dB/100ft	190 W
12" 24" 36" 48"	60"	72"	Custom Len.
\$102.47 \$109.85 \$117.23 \$124.63	\$131.99	\$139.38	See Web

24

RG223/U Coax, 50 Ohm

Part No. PE3816	Cable Dia.	Attn. @ 1 GHz	Power @ 1 GHz
1 piece price shown. See web or call for volume pricing.	0.210" dia.	13 dB/100ft	53 W
12" 24" 36" 48"	60"	72"	Custom Len.
\$65.03 \$67.93 \$70.83 \$73.74	\$76.64	\$86.10	See Web

25

RG316/U Coax, 50 Ohm

Part No. PE3842	Cable Dia.	Attn. @ 1 GHz	Power @ 1 GHz
1 piece price shown. See web or call for volume pricing.	0.098" dia.	38 dB/100ft	160 W
12" 24" 36" 48"	60"	72"	Custom Len.
\$86.27 \$89.40 \$85.67 \$88.54	\$91.43	\$94.32	See Web

26

RG316-DS Coax, 50 Ohm

Part No. PE3389	Cable Dia.	Attn. @ 1 GHz	Power @ 1 GHz
1 piece price shown. See web or call for volume pricing.	0.114" dia.	26 dB/100ft	160 W
12" 24" 36" 48"	60"	72"	Custom Len.
\$76.14 \$79.27 \$82.38 \$79.23	\$88.88	\$85.04	See Web

27

Cable Assemblies

See Our Website For Current Pricing & Real-Time Stock Availability!

For Custom Lengths, Metric Lengths or Special Configurations, Please call (949) 261-1920

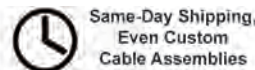
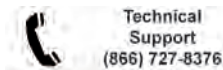

For our complete selection of cable assemblies, please visit our website

Cable Assemblies

See Our Website For Current Pricing & Real-Time Stock Availability!

RG400/U Coax, 50 Ohm				
Part No. PE3458	Cable Dia.	Attn. @ 1 GHz	Power @ 1 GHz	28
1 piece price shown. See web or call for volume pricing.	0.195" dia.	15 dB/100ft	650 W	
12" 24" 36" 48"	60"	72"	Custom Len.	
\$75.92 \$82.89 \$89.85 \$96.82	\$103.80	\$110.77	See Web	
PE-P195 Coax, 50 Ohm				
Part No. PE37640	Cable Dia.	Attn. @ 1 GHz	Power @ 1 GHz	29
1 piece price shown. See web or call for volume pricing.	0.195" dia.	13 dB/100ft	650 W	
12" 24" 36" 48"	60"	-	Custom Len.	
\$67.35 \$76.19 \$85.04 \$93.90	\$102.76	-	See Web	
RG179B/U Coax, 75 Ohm				
Part No. PE3366	Cable Dia.	Attn. @ 1 GHz	Power @ 1 GHz	30
1 piece price shown. See web or call for volume pricing.	0.100" dia.	25 dB/100ft	200 W	
12" 24" 36" 48"	60"	72"	Custom Len.	
\$73.36 \$75.75 \$78.09 \$80.51	\$82.85	\$85.24	See Web	
BNC MALE RIGHT ANGLE TO BNC FEMALE BULKHEAD SEE MOUNTING HOLE SECTION ON PAGE 369				
Standard Flexible Cable Assemblies				
RG58C/U Coax, 50 Ohm				
Part No. PE33189	Cable Dia.	Attn. @ 1 GHz	Power @ 1 GHz	31
1 piece price shown. See web or call for volume pricing.	0.195" dia.	20 dB/100ft	44 W	
12" 24" 36" 48"	60"	-	Custom Len.	
\$62.70 \$63.51 \$64.33 \$62.51	\$66.02	-	See Web	
RG400/U Coax, 50 Ohm				
Part No. PE3C3314	Cable Dia.	Attn. @ 1 GHz	Power @ 1 GHz	32
1 piece price shown. See web or call for volume pricing.	0.195" dia.	15 dB/100ft	650 W	
12" 24" 36" 48"	60"	50CM	Custom Len.	
\$68.39 \$75.56 \$82.74 \$89.92	\$97.09	\$72.98	See Web	
BNC MALE RIGHT ANGLE TO SMA FEMALE				
Standard Flexible Cable Assemblies				
RG316/U Coax, 50 Ohm				
Part No. PE3W04854	Cable Dia.	Attn. @ 1 GHz	Power @ 1 GHz	33
1 piece price shown. See web or call for volume pricing.	0.098" dia.	58 dB/100ft	160 W	
12" 24" 36" 48"	60"	50CM	Custom Len.	
\$54.52 \$57.79 \$61.07 \$64.36	\$67.64	\$56.62	See Web	
BNC MALE RIGHT ANGLE TO TNC MALE RIGHT ANGLE				
Low Loss Flexible Cable Assemblies				
LMR-240-UF Coax, 50 Ohm				
Part No. PE3W07480	Cable Dia.	Attn. @ 1 GHz	Power @ 1 GHz	34
1 piece price shown. See web or call for volume pricing.	0.240" dia.	9 dB/100ft	W	
12" 18" 24" 36"	48"	60"	Custom Len.	
\$65.75 \$66.40 \$67.05 \$68.35	\$69.65	\$70.95	See Web	
BNC FEMALE TO BNC MALE RIGHT ANGLE				
Standard Flexible Cable Assemblies				
RG174A/U Coax, 50 Ohm				
Part No. PE3W06649	Cable Dia.	Attn. @ 1 GHz	Power @ 1 GHz	35
1 piece price shown. See web or call for volume pricing.	0.110" dia.	32 dB/100ft	17 W	
12" 24" 36" 48"	60"	50CM	Custom Len.	
\$84.73 \$85.29 \$85.85 \$86.41	\$86.97	\$85.08	See Web	
BNC FEMALE TO BNC FEMALE				
Standard Flexible Cable Assemblies				
RG58C/U Coax, 50 Ohm				
Part No. PE3052	Cable Dia.	Attn. @ 1 GHz	Power @ 1 GHz	36
1 piece price shown. See web or call for volume pricing.	0.195" dia.	20 dB/100ft	44 W	
12" 24" 36" 48"	60"	72"	Custom Len.	
\$39.11 \$39.85 \$44.65 \$45.51	\$42.06	\$47.16	See Web	
RG142B/U Coax, 50 Ohm				
Part No. PE3088	Cable Dia.	Attn. @ 1 GHz	Power @ 1 GHz	37
1 piece price shown. See web or call for volume pricing.	0.195" dia.	13 dB/100ft	W	
12" 24" 36" 48"	60"	72"	Custom Len.	
\$37.48 \$42.99 \$48.57 \$58.32	\$59.67	\$65.21	See Web	
RG174A/U Coax, 50 Ohm				
Part No. PE3604	Cable Dia.	Attn. @ 1 GHz	Power @ 1 GHz	38
1 piece price shown. See web or call for volume pricing.	0.100" dia.	32 dB/100ft	16 W	
12" 24" 36" 48"	60"	72"	Custom Len.	
\$51.17 \$51.75 \$52.33 \$52.95	\$50.94	\$54.12	See Web	

RG178B/U Coax, 50 Ohm				
Part No. PE36455	Cable Dia.	Attn. @ 1 GHz	Power @ 1 GHz	39
1 piece price shown. See web or call for volume pricing.	0.072" dia.	44 dB/100ft	78 W	
12" 24" 36" 48"	60"	-	Custom Len.	
\$73.39 \$68.93 \$75.51 \$76.64	\$71.81	-	See Web	
RG188A/U Coax, 50 Ohm				
Part No. PE3094	Cable Dia.	Attn. @ 1 GHz	Power @ 1 GHz	40
1 piece price shown. See web or call for volume pricing.	0.110" dia.	26 dB/100ft	160 W	
12" 24" 36" 48"	60"	72"	Custom Len.	
\$52.00 \$59.69 \$56.44 \$58.66	\$60.89	\$63.10	See Web	
RG223/U Coax, 50 Ohm				
Part No. PE3364	Cable Dia.	Attn. @ 1 GHz	Power @ 1 GHz	41
1 piece price shown. See web or call for volume pricing.	0.210" dia.	13 dB/100ft	53 W	
12" 24" 36" 48"	60"	72"	Custom Len.	
\$34.84 \$37.77 \$40.65 \$47.85	\$46.54	\$49.43	See Web	
RG316/U Coax, 50 Ohm				
Part No. PE3505	Cable Dia.	Attn. @ 1 GHz	Power @ 1 GHz	42
1 piece price shown. See web or call for volume pricing.	0.098" dia.	38 dB/100ft	160 W	
12" 24" 36" 48"	60"	72"	Custom Len.	
\$52.91 \$55.79 \$63.39 \$66.69	\$64.47	\$67.35	See Web	
RG59B/U Coax, 75 Ohm				
Part No. PE3675	Cable Dia.	Attn. @ 1 GHz	Power @ 1 GHz	43
1 piece price shown. See web or call for volume pricing.	0.242" dia.	12 dB/100ft	77 W	
12" 24" 36" 48"	60"	72"	Custom Len.	
\$23.07 \$23.94 \$24.80 \$25.67	\$26.53	\$27.40	See Web	
BNC FEMALE TO SMA MALE				
Standard Flexible Cable Assemblies				
RG174A/U Coax, 50 Ohm				
Part No. PE3W06305	Cable Dia.	Attn. @ 1 GHz	Power @ 1 GHz	44
1 piece price shown. See web or call for volume pricing.	0.110" dia.	32 dB/100ft	17 W	
12" 18" 24" 36"	48"	60"	Custom Len.	
\$44.30 \$44.57 \$44.84 \$45.38	\$45.92	\$46.46	See Web	
BNC FEMALE BULKHEAD TO SMA MALE SEE MOUNTING HOLE SECTION ON PAGE 369				
Standard Formable Cable Assemblies				
PE-SR405FLJ Coax, 50 Ohm				
Part No. PE3W03377	Cable Dia.	Attn. @ 1 GHz	Power @ 1 GHz	45
1 piece price shown. See web or call for volume pricing.	0.098" dia.	dB/100ft	122 W	
12" 24" 36" 48"	60"	50CM	Custom Len.	
\$76.08 \$85.02 \$93.98 \$102.93	\$111.89	\$81.81	See Web	
Standard Flexible Cable Assemblies				
RG58C/U Coax, 50 Ohm				
Part No. PE3W01634	Cable Dia.	Attn. @ 1 GHz	Power @ 1 GHz	46
1 piece price shown. See web or call for volume pricing.	0.195" dia.	20 dB/100ft	80 W	
12" 24" 36" 48"	60"	50CM	Custom Len.	
\$33.62 \$34.48 \$35.35 \$36.21	\$37.07	\$34.17	See Web	
C MALE TO C MALE				
Standard Flexible Cable Assemblies				
RG8A/U Coax, 50 Ohm				
Part No. PE33316	Cable Dia.	Attn. @ 1 GHz	Power @ 1 GHz	47
1 piece price shown. See web or call for volume pricing.	0.405" dia.	8 dB/100ft	190 W	
12" 24" 36" 48"	60"	72"	Custom Len.	
\$98.31 \$107.28 \$103.98 \$106.81	\$109.65	\$112.48	See Web	
RG58C/U Coax, 50 Ohm				
Part No. PE3457	Cable Dia.	Attn. @ 1 GHz	Power @ 1 GHz	48
1 piece price shown. See web or call for volume pricing.	0.195" dia.	20 dB/100ft	44 W	
12" 24" 36" 48"	60"	72"	Custom Len.	
\$91.37 \$92.11 \$100.31 \$93.56	\$94.30	\$95.04	See Web	
RG142B/U Coax, 50 Ohm				
Part No. PE3518	Cable Dia.	Attn. @ 1 GHz	Power @ 1 GHz	49
1 piece price shown. See web or call for volume pricing.	0.195" dia.	13 dB/100ft	650 W	
12" 24" 36" 48"	60"	72"	Custom Len.	
\$74.58 \$80.30 \$86.04 \$91.76	\$97.50	\$103.24	See Web	
RG213/U Coax, 50 Ohm				
Part No. PE3522	Cable Dia.	Attn. @ 1 GHz	Power @ 1 GHz	50
1 piece price shown. See web or call for volume pricing.	0.405" dia.	8 dB/100ft	190 W	
12" 24" 36" 48"	60"	72"	Custom Len.	
\$97.16 \$98.83 \$100.48 \$102.15	\$103.81	\$105.48	See Web	
RG214/U Coax, 50 Ohm				
Part No. PE3605	Cable Dia.	Attn. @ 1 GHz	Power @ 1 GHz	51
1 piece price shown. See web or call for volume pricing.	0.425" dia.	7 dB/100ft	190 W	
12" 24" 36" 48"	60"	72"	Custom Len.	
\$89.74 \$97.05 \$110.68 \$111.71	\$119.03	\$134.78	See Web	

*Coax Performance at 1 GHz Notes: Cable assembly max frequency may be lower than connector or coax max frequency

For our complete selection of cable assemblies, please visit our website

RG217/U Coax, 50 Ohm					Cable Dia.	Attn. @ 1 GHz	Power @ 1 GHz
1 piece price shown. See web or call for volume pricing.					0.545" dia.	6 dB/100ft	260 W
12"	24"	36"	48"	60"	72"	Custom Len.	
\$152.71	\$157.12	\$161.52	\$165.92	\$181.12	\$174.73	See Web	

RG223/U Coax, 50 Ohm					Cable Dia.	Attn. @ 1 GHz	Power @ 1 GHz
1 piece price shown. See web or call for volume pricing.					0.210" dia.	13 dB/100ft	53 W
12"	24"	36"	48"	60"	72"	Custom Len.	
\$71.72	\$74.62	\$77.52	\$80.42	\$83.32	\$86.22	See Web	

RG225/U Coax, 50 Ohm					Cable Dia.	Attn. @ 1 GHz	Power @ 1 GHz
1 piece price shown. See web or call for volume pricing.					0.430" dia.	8 dB/100ft	1700 W
12"	24"	36"	48"	60"	72"	Custom Len.	
\$109.85	\$142.44	\$175.02	\$207.61	\$240.21	\$272.80	See Web	

RG393/U Coax, 50 Ohm					Cable Dia.	Attn. @ 1 GHz	Power @ 1 GHz
1 piece price shown. See web or call for volume pricing.					0.390" dia.	8 dB/100ft	1700 W
12"	24"	36"	48"	60"	72"	Custom Len.	
\$98.43	\$120.74	\$137.15	\$144.84	\$171.24	\$187.97	See Web	

C MALE RIGHT ANGLE TO C MALE



Standard Flexible Cable Assemblies

RG214/U Coax, 50 Ohm					Cable Dia.	Attn. @ 1 GHz	Power @ 1 GHz
1 piece price shown. See web or call for volume pricing.					0.425" dia.	7 dB/100ft	170 W
12"	18"	24"	36"	48"	60"	Custom Len.	
\$144.35	\$148.20	\$152.06	\$159.77	\$167.48	\$175.19	See Web	

FAKRA PLUG TO FAKRA PLUG



Low Loss Flexible Cable Assemblies

PE-C100-LSZH Coax, 50 Ohm					Cable Dia.	Attn. @ 1 GHz	Power @ 1 GHz
1 piece price shown. See web or call for volume pricing.					0.109" dia.	25 dB/100ft	W
12"	24"	36"	48"	60"	-	Custom Len.	
\$21.86	\$24.45	\$25.72	\$27.63	\$29.60	-	See Web	

PE-C100-LSZH Coax, 50 Ohm					Cable Dia.	Attn. @ 1 GHz	Power @ 1 GHz
1 piece price shown. See web or call for volume pricing.					0.109" dia.	25 dB/100ft	W
12"	24"	36"	48"	60"	-	Custom Len.	
\$26.97	\$26.18	\$27.40	\$31.03	\$32.39	-	See Web	

Standard Flexible Cable Assemblies

RG174A/U Coax, 50 Ohm					Cable Dia.	Attn. @ 1 GHz	Power @ 1 GHz
1 piece price shown. See web or call for volume pricing.					0.100" dia.	32 dB/100ft	16 W
12"	24"	36"	48"	60"	-	Custom Len.	
\$29.28	\$27.16	\$27.68	\$28.18	\$28.71	-	See Web	

RG174A/U Coax, 50 Ohm					Cable Dia.	Attn. @ 1 GHz	Power @ 1 GHz
1 piece price shown. See web or call for volume pricing.					0.100" dia.	32 dB/100ft	16 W
12"	24"	36"	48"	60"	-	Custom Len.	
\$32.21	\$29.72	\$30.15	\$30.59	\$34.57	-	See Web	

Standard Flexible Cable Assemblies

RG316/U Coax, 50 Ohm					Cable Dia.	Attn. @ 1 GHz	Power @ 1 GHz
1 piece price shown. See web or call for volume pricing.					0.098" dia.	38 dB/100ft	160 W
12"	24"	36"	48"	60"	-	Custom Len.	
\$30.71	\$30.64	\$33.41	\$36.18	\$38.95	-	See Web	

PE-C100-LSZH Coax, 50 Ohm					Cable Dia.	Attn. @ 1 GHz	Power @ 1 GHz
1 piece price shown. See web or call for volume pricing.					0.098" dia.	38 dB/100ft	160 W
12"	24"	36"	48"	60"	-	Custom Len.	
\$29.01	\$31.83	\$34.71	\$41.47	\$40.47	-	See Web	

FAKRA PLUG TO FAKRA JACK



Low Loss Flexible Cable Assemblies

PE-C100-LSZH Coax, 50 Ohm					Cable Dia.	Attn. @ 1 GHz	Power @ 1 GHz
1 piece price shown. See web or call for volume pricing.					0.109" dia.	25 dB/100ft	W
12"	24"	36"	48"	60"	-	Custom Len.	
\$24.98	\$26.18	\$27.40	\$28.71	\$32.88	-	See Web	

PE-C100-LSZH Coax, 50 Ohm					Cable Dia.	Attn. @ 1 GHz	Power @ 1 GHz
1 piece price shown. See web or call for volume pricing.					0.109" dia.	25 dB/100ft	W
12"	24"	36"	48"	60"	-	Custom Len.	
\$27.47	\$26.18	\$30.13	\$28.71	\$32.88	-	See Web	

PE-C100-LSZH Coax, 50 Ohm					Cable Dia.	Attn. @ 1 GHz	Power @ 1 GHz
1 piece price shown. See web or call for volume pricing.					0.109" dia.	25 dB/100ft	W
12"	24"	36"	48"	60"	-	Custom Len.	
\$24.98	\$26.18	\$27.40	\$28.71	\$30.75	-	See Web	

RG316/U Coax, 50 Ohm					Cable Dia.	Attn. @ 1 GHz	Power @ 1 GHz
1 piece price shown. See web or call for volume pricing.					0.109" dia.	25 dB/100ft	W
12"	24"	36"	48"	60"	-	Custom Len.	
\$24.98	\$26.18	\$29.63	\$28.71	\$32.39	-	See Web	

RG316/U Coax, 50 Ohm					Cable Dia.	Attn. @ 1 GHz	Power @ 1 GHz
1 piece price shown. See web or call for volume pricing.					0.109" dia.	25 dB/100ft	W
12"	24"	36"	48"	60"	-	Custom Len.	
\$26.49	\$27.82	\$29.14	\$30.56	\$31.91	-	See Web	

Standard Flexible Cable Assemblies

RG174A/U Coax, 50 Ohm					Cable Dia.	Attn. @ 1 GHz	Power @ 1 GHz
1 piece price shown. See web or call for volume pricing.					0.100" dia.	32 dB/100ft	16 W
12"	24"	36"	48"	60"	-	Custom Len.	
\$29.28	\$29.72	\$30.15	\$30.59	\$31.02	-	See Web	

PE-C100-LSZH Coax, 50 Ohm					Cable Dia.	Attn. @ 1 GHz	Power @ 1 GHz
1 piece price shown. See web or call for volume pricing.					0.100" dia.	32 dB/100ft	16 W
12"	24"	36"	48"	60"	-	Custom Len.	
\$29.28	\$29.72	\$30.15	\$30.59	\$34.57	-	See Web	

PE-C100-LSZH Coax, 50 Ohm					Cable Dia.	Attn. @ 1 GHz	Power @ 1 GHz
1 piece price shown. See web or call for volume pricing.					0.100" dia.	32 dB/100ft	16 W
12"	24"	36"	48"	60"	-	Custom Len.	
\$29.28	\$29.72	\$30.15	\$30.59	\$31.02	-	See Web	

PE-C100-LSZH Coax, 50 Ohm					Cable Dia.	Attn. @ 1 GHz	Power @ 1 GHz
1 piece price shown. See web or call for volume pricing.					0.100" dia.	32 dB/100ft	16 W
12"	24"	36"	48"	60"	-	Custom Len.	
\$29.28	\$29.72	\$30.15	\$30.59	\$33.98	-	See Web	

PE-C100-LSZH Coax, 50 Ohm					Cable Dia.	Attn. @ 1 GHz	Power @ 1 GHz
1 piece price shown. See web or call for volume pricing.					0.100" dia.	32 dB/100ft	16 W
12"	24"	36"	48"	60"	-	Custom Len.	
\$29.28	\$29.72	\$30.15	\$30.59	\$34.57	-	See Web	

PE-C100-LSZH Coax, 50 Ohm					Cable Dia.	Attn. @ 1 GHz	Power @ 1 GHz
1 piece price shown. See web or call for volume pricing.					0.100" dia.	32 dB/100ft	16 W
12"	24"	36"	48"	60"	-	Custom Len.	
\$28.75	\$31.63	\$29.61	\$32.81	\$30.49	-	See Web	

PE-C100-LSZH Coax, 50 Ohm					Cable Dia.	Attn. @ 1 GHz	Power @ 1 GHz
1 piece price shown. See web or call for volume pricing.					0.100" dia.	32 dB/100ft	16 W
12"	24"	36"	48"	60"	-	Custom Len.	
\$31.05	\$31.63	\$32.21	\$32.81	\$33.40	-	See Web	

RG316/U Coax, 50 Ohm					Cable Dia.	Attn. @ 1 GHz	Power @ 1 GHz
1 piece price shown. See web or call for volume pricing.					0.098" dia.	38 dB/100ft	160 W
12"	24"	36"	48"	60"	-	Custom Len.	
\$31.91	\$34.80	\$37.69	\$40.58	\$43.47	-	See Web	

PE-C100-LSZH Coax, 50 Ohm					Cable Dia.	Attn. @ 1 GHz	Power @ 1 GHz
1 piece price shown. See web or call for volume pricing.					0.098" dia.	38 dB/100ft	160 W
12"	24"	36"	48"	60"	-	Custom Len.	
\$29.01	\$31.83	\$34.71	\$37.59	\$44.66	-	See Web	

PE-C100-LSZH Coax, 50 Ohm					Cable Dia.	Attn. @ 1 GHz	Power @ 1 GHz
1 piece price shown. See web or call for volume pricing.					0.098" dia.	38 dB/100ft	160 W
12"	24"	36"	48"	60"	-	Custom Len.	
\$31.91	\$34.80	\$37.69	\$40.58	\$43.47	-	See Web	

PE-C100-LSZH Coax, 50 Ohm					Cable Dia.	Attn. @ 1 GHz	Power @ 1 GHz
1 piece price shown. See web or call for volume pricing.					0.098" dia.	38 dB/100ft	160 W
12"	24"	36"	48"	60"	-	Custom Len.	
\$35.10	\$38.22	\$41.35	\$40.58	\$47.85	-	See Web	

FAKRA PLUG TO FAKRA JACK RIGHT ANGLE



Low Loss Flexible Cable Assemblies

PE-C100-LSZH Coax, 50 Ohm					Cable Dia.	Attn. @ 1 GHz	Power @ 1 GHz
1 piece price shown. See web or call for volume pricing.					0.109" dia.	25 dB/100ft	W
12"	24"	36"	48"	60"	-	Custom Len.	
\$24.17	\$22.61	\$23.29	\$23.94	\$24.63	-	See Web	

PE-C100-LSZH Coax, 50 Ohm					Cable Dia.	Attn. @ 1 GHz	Power @ 1 GHz
1 piece price shown. See web or call for volume pricing.					0.109" dia.	25 dB/100ft	W
12"	24"	36"	48"	60"	-	Custom Len.	
\$23.97	\$25.94	\$27.98	\$30.42	\$32.01	-	See Web	

PE-C100-LSZH Coax, 50 Ohm					Cable Dia.	Attn. @ 1 GHz	Power @ 1 GHz
1 piece price shown. See web or call for volume pricing.					0.109" dia.	25 dB/100ft	W
12"	24"	36"	48"	60"	-	Custom Len.	
\$21.97	\$22.61	\$23.29	\$23.94	\$24.63	-	See Web	

PE-C100-LSZH Coax, 50 Ohm					Cable Dia.	Attn. @ 1 GHz	Power @ 1 GHz
1 piece price shown. See web or call for volume pricing.					0.109" dia.	25 dB/100ft	W
12"	24"	36"	48"	60"	-	Custom Len.	
\$21.97	\$22.61	\$23.29	\$23.94	\$24.63	-	See Web	

PE-C100-LSZH Coax, 50 Ohm					Cable Dia.	Attn. @ 1 GHz	Power @ 1 GHz
1 piece price shown. See web or call for volume pricing.					0.109" dia.	25 dB/100ft	W
12"	24"	36"	48"	60"	-	Custom Len.	
\$26.38	\$27.58	\$28.78	\$30.00	\$32.01	-	See Web	

Standard Flexible Cable Assemblies

Cable Assemblies

See Our Website For Current Pricing & Real-Time Stock Availability!

Continued on Next Page

For Custom Lengths, Metric Lengths or Special Configurations, Please call (949) 261-1920

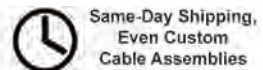
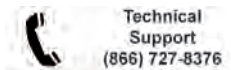

For our complete selection of cable assemblies, please visit our website

RG174A/U Coax, 50 Ohm				
Part No. PE38753C	Cable Dia.	Attn. @ 1 GHz	Power @ 1 GHz	
1 piece price shown. See web or call for volume pricing.				
12"	24"	36"	48"	60"
\$35.88	\$36.30	\$36.74	\$37.18	\$41.10
				See Web



Flexible Cable Assemblies

PE-C100-LSZH Coax, 50 Ohm				
Part No. PE38746A	Cable Dia.	Attn. @ 1 GHz	Power @ 1 GHz	
1 piece price shown. See web or call for volume pricing.				
12"	24"	36"	48"	60"
\$27.47	\$28.80	\$27.40	\$28.71	\$30.75
				See Web

Low Loss Flexible Cable Assemblies

PE-C100-LSZH Coax, 50 Ohm				
Part No. PE38746B	Cable Dia.	Attn. @ 1 GHz	Power @ 1 GHz	
1 piece price shown. See web or call for volume pricing.				
12"	24"	36"	48"	60"
\$26.97	\$28.30	\$27.40	\$28.71	\$32.39
				See Web

Part No. PE38746C	Cable Dia.	Attn. @ 1 GHz	Power @ 1 GHz	
1 piece price shown. See web or call for volume pricing.				
12"	24"	36"	48"	60"
\$27.47	\$28.80	\$27.40	\$31.53	\$32.88
				See Web

Part No. PE38746D	Cable Dia.	Attn. @ 1 GHz	Power @ 1 GHz	
1 piece price shown. See web or call for volume pricing.				
12"	24"	36"	48"	60"
\$24.98	\$26.18	\$29.63	\$31.03	\$30.75
				See Web

Part No. PE38746H	Cable Dia.	Attn. @ 1 GHz	Power @ 1 GHz	
1 piece price shown. See web or call for volume pricing.				
12"	24"	36"	48"	60"
\$21.51	\$22.23	\$22.94	\$23.61	\$24.32
				See Web

Part No. PE38746I	Cable Dia.	Attn. @ 1 GHz	Power @ 1 GHz	
1 piece price shown. See web or call for volume pricing.				
12"	24"	36"	48"	60"
\$24.98	\$26.18	\$30.13	\$28.71	\$32.88
				See Web

Part No. PE38746K	Cable Dia.	Attn. @ 1 GHz	Power @ 1 GHz	
1 piece price shown. See web or call for volume pricing.				
12"	24"	36"	48"	60"
\$24.98	\$26.18	\$27.40	\$31.53	\$30.75
				See Web

Standard Flexible Cable Assemblies

RG174A/U Coax, 50 Ohm				
Part No. PE38750A	Cable Dia.	Attn. @ 1 GHz	Power @ 1 GHz	
1 piece price shown. See web or call for volume pricing.				
12"	24"	36"	48"	60"
\$29.28	\$29.72	\$33.36	\$30.59	\$31.02
				See Web

Part No. PE38750B	Cable Dia.	Attn. @ 1 GHz	Power @ 1 GHz	
1 piece price shown. See web or call for volume pricing.				
12"	24"	36"	48"	60"
\$26.62	\$27.16	\$29.90	\$28.18	\$28.71
				See Web

Part No. PE38750C	Cable Dia.	Attn. @ 1 GHz	Power @ 1 GHz	
1 piece price shown. See web or call for volume pricing.				
12"	24"	36"	48"	60"
\$29.28	\$29.72	\$32.19	\$30.59	\$33.39
				See Web

Part No. PE38750D	Cable Dia.	Attn. @ 1 GHz	Power @ 1 GHz	
1 piece price shown. See web or call for volume pricing.				
12"	24"	36"	48"	60"
\$29.28	\$29.72	\$32.78	\$30.59	\$33.98
				See Web

Part No. PE38750H	Cable Dia.	Attn. @ 1 GHz	Power @ 1 GHz	
1 piece price shown. See web or call for volume pricing.				
12"	24"	36"	48"	60"
\$28.75	\$31.63	\$29.61	\$32.81	\$30.49
				See Web

Part No. PE38750I	Cable Dia.	Attn. @ 1 GHz	Power @ 1 GHz	
1 piece price shown. See web or call for volume pricing.				
12"	24"	36"	48"	60"
\$26.62	\$27.16	\$27.68	\$28.18	\$28.71
				See Web

Part No. PE38750K	Cable Dia.	Attn. @ 1 GHz	Power @ 1 GHz	
1 piece price shown. See web or call for volume pricing.				
12"	24"	36"	48"	60"
\$29.28	\$32.20	\$30.15	\$30.59	\$31.02
				See Web

Part No. PE38750Z				Cable Dia.	Attn. @ 1 GHz	Power @ 1 GHz
1 piece price shown. See web or call for volume pricing.						
12"	24"	36"	48"	60"	60"	16 W
\$29.35	\$29.92	\$30.51	\$31.12	\$31.70	-	Custom Len.
						See Web

RG188-DS Coax, 50 Ohm						
Part No. PE3W02209				Cable Dia.	Attn. @ 1 GHz	Power @ 1 GHz
1 piece price shown. See web or call for volume pricing.						
12"	24"	36"	48"	60"	30 dB/100ft	160 W
\$30.47	\$33.89	\$37.31	\$40.73	\$44.15	50CM	Custom Len.
						See Web

RG316/U Coax, 50 Ohm						
Part No. PE38754C				Cable Dia.	Attn. @ 1 GHz	Power @ 1 GHz
1 piece price shown. See web or call for volume pricing.						
12"	24"	36"	48"	60"	38 dB/100ft	160 W
\$30.75	\$33.87	\$37.00	\$37.59	\$40.47	-	Custom Len.
						See Web

Part No. PE38754D				Cable Dia.	Attn. @ 1 GHz	Power @ 1 GHz
1 piece price shown. See web or call for volume pricing.						
12"	24"	36"	48"	60"	38 dB/100ft	160 W
\$31.91	\$35.04	\$34.71	\$37.59	\$40.47	-	Custom Len.
						See Web

Part No. PE38754H				Cable Dia.	Attn. @ 1 GHz	Power @ 1 GHz
1 piece price shown. See web or call for volume pricing.						
12"	24"	36"	48"	60"	38 dB/100ft	160 W
\$29.01	\$31.83	\$37.00	\$37.59	\$40.47	-	Custom Len.
						See Web

Part No. PE38754Z				Cable Dia.	Attn. @ 1 GHz	Power @ 1 GHz
1 piece price shown. See web or call for volume pricing.						
12"	24"	36"	48"	60"	38 dB/100ft	W
\$32.27	\$35.40	\$38.53	\$41.83	\$45.02	-	Custom Len.
						See Web



Low Loss Flexible Cable Assemblies

LMR-100A-PVC Coax, 50 Ohm						
Part No. PE3W02943				Cable Dia.	Attn. @ 1 GHz	Power @ 1 GHz
1 piece price shown. See web or call for volume pricing.						
12"	24"	36"	48"	60"	24 dB/100ft	W
\$23.77	\$24.51	\$25.24	\$25.98	\$26.71	50CM	Custom Len.
						See Web



Standard Flexible Cable Assemblies

RG316/U Coax, 50 Ohm						
Part No. PE39351Z				Cable Dia.	Attn. @ 1 GHz	Power @ 1 GHz
1 piece price shown. See web or call for volume pricing.						
12"	24"	36"	48"	60"	38 dB/100ft	W
\$56.60	\$54.34	\$57.24	\$60.13	\$63.02	-	Custom Len.
						See Web



Low Loss Flexible Cable Assemblies

LMR-100A-PVC Coax, 50 Ohm						
Part No. PE3W03361				Cable Dia.	Attn. @ 1 GHz	Power @ 1 GHz
1 piece price shown. See web or call for volume pricing.						
12"	24"	36"	48"	60"	24 dB/100ft	W
\$40.35	\$41.07	\$41.80	\$42.53	\$43.25	50CM	Custom Len.
						See Web



Standard Flexible Cable Assemblies

RG316/U Coax, 50 Ohm						
Part No. PE38757Z				Cable Dia.	Attn. @ 1 GHz	Power @ 1 GHz
1 piece price shown. See web or call for volume pricing.						
12"	24"	36"	48"	60"	38 dB/100ft	W
\$43.01	\$42.00	\$44.88	\$47.77	\$50.66	-	Custom Len.
						See Web

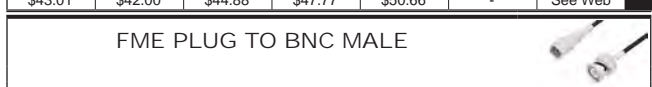

Standard Flexible Cable Assemblies

RG174A/U Coax, 50 Ohm						
Part No. PE3C3420				Cable Dia.	Attn. @ 1 GHz	Power @ 1 GHz
1 piece price shown. See web or call for volume pricing.						
12"	24"	36"	48"	60"	32 dB/100ft	17 W
\$36.34	\$36.76	\$37.22	\$37.61	\$38.03	72"	Custom Len.
						See Web

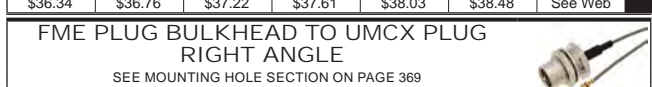

Standard Flexible Cable Assemblies

Cable Assemblies See Our Website For Current Pricing & Real-Time Stock Availability!

*Coax Performance at 1 GHz Notes: Cable assembly max frequency may be lower than connector or coax max frequency

For our complete selection of cable assemblies, please visit our website

PE-113mm Coax, 50 Ohm					Cable Dia.	Attn. @ 1 GHz	Power @ 1 GHz
Part No. PE38858					0.044" dia.	dB/100ft	W
1 piece price shown. See web or call for volume pricing.							
6"	12"	18"	-	-	-	Custom Len.	
\$31.03	\$14.02	\$30.02	-	-	-	See Web	

FME JACK TO BNC MALE



Standard Flexible Cable Assemblies

RG58C/U Coax, 50 Ohm					Cable Dia.	Attn. @ 1 GHz	Power @ 1 GHz
Part No. PE34862					0.195" dia.	20 dB/100ft	44 W
1 piece price shown. See web or call for volume pricing.							
12"	24"	36"	48"	60"	72"	Custom Len.	
\$33.09	\$33.82	\$34.59	\$35.31	\$36.02	\$36.76	See Web	

FME JACK TO FME JACK



Standard Flexible Cable Assemblies

RG58C/U Coax, 50 Ohm					Cable Dia.	Attn. @ 1 GHz	Power @ 1 GHz
Part No. PE34856					0.195" dia.	20 dB/100ft	44 W
1 piece price shown. See web or call for volume pricing.							
12"	24"	36"	48"	60"	72"	Custom Len.	
\$37.80	\$38.54	\$39.27	\$40.01	\$40.75	\$41.48	See Web	

RG174A/U Coax, 50 Ohm					Cable Dia.	Attn. @ 1 GHz	Power @ 1 GHz
Part No. PE34860					0.100" dia.	32 dB/100ft	16 W
1 piece price shown. See web or call for volume pricing.							
12"	24"	36"	48"	60"	72"	Custom Len.	
\$44.32	\$40.71	\$41.20	\$41.62	\$42.09	\$42.51	See Web	

GR874 SEXLESS TO BNC MALE



Standard Flexible Cable Assemblies

RG214/U Coax, 50 Ohm					Cable Dia.	Attn. @ 1 GHz	Power @ 1 GHz
Part No. PE3145					0.425" dia.	7 dB/100ft	170 W
1 piece price shown. See web or call for volume pricing.							
12"	24"	36"	48"	60"	72"	Custom Len.	
\$138.78	\$146.16	\$153.54	\$160.93	\$168.30	\$175.69	See Web	

RG223/U Coax, 50 Ohm					Cable Dia.	Attn. @ 1 GHz	Power @ 1 GHz
Part No. PE3182					0.209" dia.	13 dB/100ft	50 W
1 piece price shown. See web or call for volume pricing.							
12"	24"	36"	48"	60"	72"	Custom Len.	
\$49.29	\$52.24	\$55.12	\$58.07	\$60.99	\$63.88	See Web	

GR874 SEXLESS TO GR874 SEXLESS



Standard Flexible Cable Assemblies

RG58C/U Coax, 50 Ohm					Cable Dia.	Attn. @ 1 GHz	Power @ 1 GHz
Part No. PE3211					0.195" dia.	20 dB/100ft	44 W
1 piece price shown. See web or call for volume pricing.							
12"	24"	36"	48"	60"	72"	Custom Len.	
\$74.15	\$74.87	\$75.59	\$76.29	\$77.01	\$77.79	See Web	

RG223/U Coax, 50 Ohm					Cable Dia.	Attn. @ 1 GHz	Power @ 1 GHz
Part No. PE3190					0.209" dia.	13 dB/100ft	50 W
1 piece price shown. See web or call for volume pricing.							
12"	24"	36"	48"	60"	72"	Custom Len.	
\$74.52	\$77.42	\$80.31	\$83.20	\$86.11	\$89.01	See Web	

HN MALE TO 7/16 DIN MALE RIGHT ANGLE



Standard Flexible Cable Assemblies

RG217/U Coax, 50 Ohm					Cable Dia.	Attn. @ 1 GHz	Power @ 1 GHz
Part No. PE3W03391					0.545" dia.	6 dB/100ft	260 W
1 piece price shown. See web or call for volume pricing.							
12"	24"	36"	48"	60"	50CM	Custom Len.	
\$259.73	\$264.62	\$269.53	\$274.43	\$279.34	\$262.87	See Web	

HN MALE TO HN MALE



Standard Flexible Cable Assemblies

RG8A/U Coax, 50 Ohm					Cable Dia.	Attn. @ 1 GHz	Power @ 1 GHz
Part No. PE33304					0.405" dia.	8 dB/100ft	190 W
1 piece price shown. See web or call for volume pricing.							
12"	24"	36"	48"	60"	72"	Custom Len.	
\$111.68	\$114.52	\$124.52	\$127.78	\$123.02	\$125.84	See Web	

Part No. PE3852				Cable Dia.	Attn. @ 1 GHz	Power @ 1 GHz
1 piece price shown. See web or call for volume pricing.				0.195" dia.	20 dB/100ft	44 W
12"	24"	36"	48"	60"	72"	Custom Len.
\$87.11	\$87.85	\$88.59	\$89.32	\$90.06	\$90.80	See Web

Part No. PE34434				Cable Dia.	Attn. @ 1 GHz	Power @ 1 GHz
1 piece price shown. See web or call for volume pricing.				0.190" dia.	13 dB/100ft	650 W
12"	24"	36"	48"	60"	72"	Custom Len.
\$93.71	\$100.00	\$106.25	\$112.48	\$118.74	\$124.98	See Web

Part No. PE3083				Cable Dia.	Attn. @ 1 GHz	Power @ 1 GHz
1 piece price shown. See web or call for volume pricing.				0.195" dia.	13 dB/100ft	W
12"	24"	36"	48"	60"	72"	Custom Len.
\$90.62	\$96.36	\$108.21	\$114.65	\$113.55	\$127.04	See Web

Part No. PE3038				Cable Dia.	Attn. @ 1 GHz	Power @ 1 GHz
1 piece price shown. See web or call for volume pricing.				0.405" dia.	9 dB/100ft	190 W
12"	24"	36"	48"	60"	72"	Custom Len.
\$117.15	\$118.93	\$120.72	\$122.61	\$124.44	\$126.26	See Web

Part No. PE3095				Cable Dia.	Attn. @ 1 GHz	Power @ 1 GHz
1 piece price shown. See web or call for volume pricing.				0.425" dia.	7 dB/100ft	170 W
12"	24"	36"	48"	60"	72"	Custom Len.
\$125.93	\$126.12	\$133.45	\$149.72	\$157.65	\$165.59	See Web

Part No. PE33370				Cable Dia.	Attn. @ 1 GHz	Power @ 1 GHz
1 piece price shown. See web or call for volume pricing.				0.545" dia.	6 dB/100ft	260 W
12"	24"	36"	48"	60"	72"	Custom Len.
\$126.03	\$130.75	\$135.46	\$140.46	\$145.27	\$150.08	See Web

Part No. PE33583				Cable Dia.	Attn. @ 1 GHz	Power @ 1 GHz
1 piece price shown. See web or call for volume pricing.				0.870" dia.	4 dB/100ft	560 W
12"	24"	36"	48"	60"	72"	Custom Len.
\$279.52	\$290.67	\$301.84	\$312.95	\$324.11	\$335.27	See Web

Part No. PE3357				Cable Dia.	Attn. @ 1 GHz	Power @ 1 GHz
1 piece price shown. See web or call for volume pricing.				0.210" dia.	13 dB/100ft	53 W
12"	24"	36"	48"	60"	72"	Custom Len.
\$87.83	\$96.21	\$99.33	\$96.52	\$105.79	\$102.32	See Web

Part No. PE33778				Cable Dia.	Attn. @ 1 GHz	Power @ 1 GHz
1 piece price shown. See web or call for volume pricing.				0.430" dia.	dB/100ft	1700 W
12"	24"	36"	48"	60"	72"	Custom Len.
\$145.51	\$179.11	\$212.71	\$246.31	\$279.91	\$313.51	See Web

Part No. PE3340				Cable Dia.	Attn. @ 1 GHz	Power @ 1 GHz
1 piece price shown. See web or call for volume pricing.				0.390" dia.	8 dB/100ft	1700 W
12"	24"	36"	48"	60"	72"	Custom Len.
\$130.29	\$138.38	\$163.10	\$180.46	\$197.18	\$213.91	See Web

Part No. PE33938				Cable Dia.	Attn. @ 1 GHz	Power @ 1 GHz
1 piece price shown. See web or call for volume pricing.				0.195" dia.	15 dB/100ft	650 W
12"	24"	36"	48"	60"	72"	Custom Len.
\$104.42	\$105.48	\$112.45	\$119.42	\$126.39	\$133.36	See Web

Part No. PE34436				Cable Dia.	Attn. @ 1 GHz	Power @ 1 GHz
1 piece price shown. See web or call for volume pricing.				0.242" dia.	12 dB/100ft	77 W
12"	24"	36"	48"	60"	72"	Custom Len.
\$110.88	\$111.77	\$112.68	\$113.57	\$114.47	\$115.37	See Web

HN MALE RIGHT ANGLE TO HN FEMALE



Standard Flexible Cable Assemblies

Part No. PE3W05081				Cable Dia.	Attn. @ 1 GHz	Power @ 1 GHz
1 piece price shown. See web or call for volume pricing.				0.405" dia.	dB/100ft	190 W
12"	24"	36"	48"	60"	50CM	Custom Len.
\$135.66	\$137.52	\$139.38	\$141.24	\$143.10	\$136.85	See Web

LC MALE TO LC MALE



Standard Flexible Cable Assemblies

Part No. PE33491				Cable Dia.	Attn. @ 1 GHz	Power @ 1 GHz
1 piece price shown. See web or call for volume pricing.				0.425" dia.	7 dB/100ft	190 W
60"	72"	84"	96"	108"	120"	Custom Len.
\$355.68	\$363.06	\$370.46	\$377.81	\$385.21	\$392.60	See Web

Part No. PE33537				Cable Dia.	Attn. @ 1 GHz	Power @ 1 GHz
1 piece price shown. See web or call for volume pricing.				0.545" dia.	6 dB/100ft	260 W
60"	72"	84"	96"	108"	120"	Custom Len.
\$400.13	\$404.53	\$408.93	\$413.33	\$417.74	\$422.15	See Web

Cable Assemblies

See Our Website For Current Pricing & Real-Time Stock Availability!

For Custom Lengths, Metric Lengths or Special Configurations, Please call (949) 261-1920

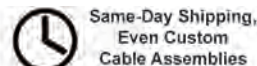
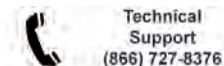

For our complete selection of cable assemblies, please visit our website

RG218/U Coax, 50 Ohm						
Part No. PE3960	Cable Dia.			Attn. @ 1 GHz	Power @ 1 GHz	
1 piece price shown. See web or call for volume pricing.						
60"	72"	84"	96"	108"	120"	Custom Len.
\$528.89	\$509.56	\$521.06	\$532.55	\$544.04	\$555.54	See Web



Standard Flexible Cable Assemblies

RG393/U Coax, 50 Ohm						
Part No. PE3W00314	Cable Dia.			Attn. @ 1 GHz	Power @ 1 GHz	
1 piece price shown. See web or call for volume pricing.						
12"	24"	36"	48"	60"	78 W	Custom Len.
\$302.57	\$318.50	\$334.42	\$350.35	\$366.28	\$312.77	See Web



Standard Flexible Cable Assemblies

RG178B/U Coax, 50 Ohm						
Part No. PE36116	Cable Dia.			Attn. @ 1 GHz	Power @ 1 GHz	
1 piece price shown. See web or call for volume pricing.						
12"	24"	36"	48"	60"	72"	Custom Len.
\$41.85	\$42.82	\$43.76	\$44.74	\$45.71	\$46.64	See Web



Standard Flexible Cable Assemblies

RG174A/U Coax, 50 Ohm						
Part No. PE3C3387	Cable Dia.			Attn. @ 1 GHz	Power @ 1 GHz	
1 piece price shown. See web or call for volume pricing.						
12"	24"	36"	48"	60"	39.37"	Custom Len.
\$35.82	\$36.39	\$36.95	\$37.51	\$38.07	Call	See Web



Standard Flexible Cable Assemblies

RG174A/U Coax, 50 Ohm						
Part No. PE3295	Cable Dia.			Attn. @ 1 GHz	Power @ 1 GHz	
1 piece price shown. See web or call for volume pricing.						
12"	24"	36"	48"	60"	72"	Custom Len.
\$46.44	\$46.87	\$47.32	\$47.75	\$48.18	\$48.61	See Web

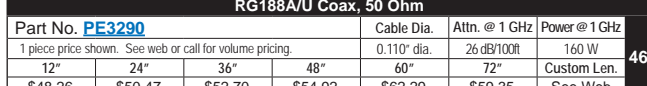

Standard Flexible Cable Assemblies

RG188A/U Coax, 50 Ohm						
Part No. PE3290	Cable Dia.			Attn. @ 1 GHz	Power @ 1 GHz	
1 piece price shown. See web or call for volume pricing.						
12"	24"	36"	48"	60"	72"	Custom Len.
\$48.26	\$50.47	\$52.70	\$54.92	\$62.29	\$59.35	See Web

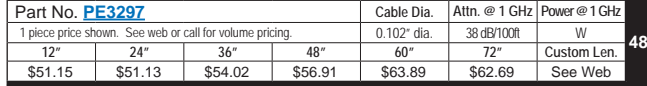

Standard Flexible Cable Assemblies

RG316/U Coax, 50 Ohm						
Part No. PE3297	Cable Dia.			Attn. @ 1 GHz	Power @ 1 GHz	
1 piece price shown. See web or call for volume pricing.						
12"	24"	36"	48"	60"	72"	Custom Len.
\$51.15	\$51.13	\$54.02	\$56.91	\$63.89	\$62.69	See Web

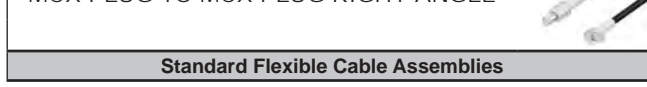

Standard Flexible Cable Assemblies

RG174A/U Coax, 50 Ohm						
Part No. PE3314	Cable Dia.			Attn. @ 1 GHz	Power @ 1 GHz	
1 piece price shown. See web or call for volume pricing.						
12"	24"	36"	48"	60"	72"	Custom Len.
\$48.83	\$49.27	\$49.70	\$50.13	\$50.57	\$51.00	See Web

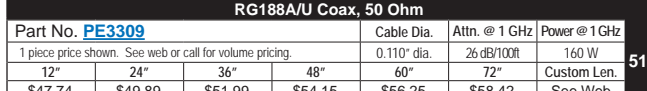

Flexible Cable Assemblies

LMR-100A-PVC Coax, 50 Ohm						
Part No. PE3W06468	Cable Dia.			Attn. @ 1 GHz	Power @ 1 GHz	
1 piece price shown. See web or call for volume pricing.						
12"	24"	36"	48"	60"	50CM	Custom Len.
\$37.14	\$37.86	\$38.59	\$39.32	\$40.04	\$37.60	See Web

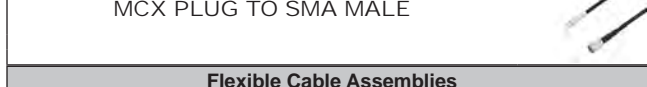

Standard Flexible Cable Assemblies

RG174A/U Coax, 50 Ohm						
Part No. PE3W03310	Cable Dia.			Attn. @ 1 GHz	Power @ 1 GHz	
1 piece price shown. See web or call for volume pricing.						
12"	24"	36"	48"	60"	50CM	Custom Len.
\$82.30	\$82.86	\$83.42	\$83.98	\$84.54	\$82.65	See Web

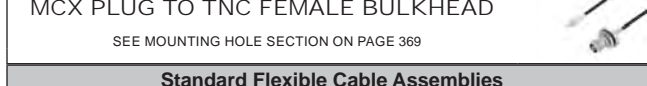

Standard Flexible Cable Assemblies

RG316/U Coax, 50 Ohm						
Part No. PE3W05645	Cable Dia.			Attn. @ 1 GHz	Power @ 1 GHz	
1 piece price shown. See web or call for volume pricing.						
12"	24"	36"	48"	60"	50CM	Custom Len.
\$91.60	\$94.87	\$98.15	\$101.44	\$104.72	\$93.70	See Web

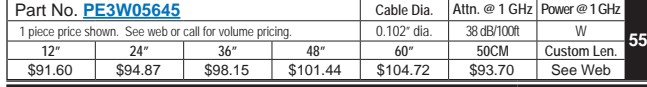

Standard Flexible Cable Assemblies

RG316-DS Coax, 50 Ohm						
Part No. PE3W01570	Cable Dia.			Attn. @ 1 GHz	Power @ 1 GHz	
1 piece price shown. See web or call for volume pricing.						
12"	24"	36"	48"	60"	50CM	Custom Len.
\$74.07	\$77.10	\$80.13	\$83.16	\$86.20	\$76.00	See Web

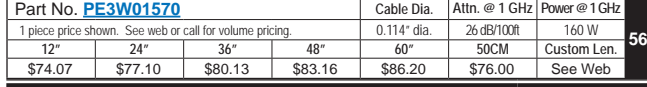

Standard Flexible Cable Assemblies

RG174A/U Coax, 50 Ohm						
Part No. PE3304	Cable Dia.			Attn. @ 1 GHz	Power @ 1 GHz	
1 piece price shown. See web or call for volume pricing.						
12"	24"	36"	48"	60"	72"	Custom Len.
\$49.12	\$49.54	\$50.01	\$50.42	\$50.86	\$51.34	See Web

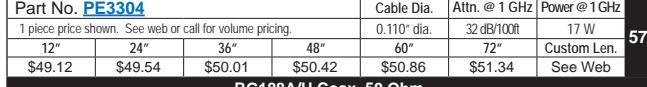

Standard Flexible Cable Assemblies

RG188A/U Coax, 50 Ohm						
Part No. PE3299	Cable Dia.			Attn. @ 1 GHz	Power @ 1 GHz	
1 piece price shown. See web or call for volume pricing.						
12"	24"	36"	48"	60"	72"	Custom Len.
\$54.87	\$57.09	\$59.32	\$61.53	\$63.75	\$65.97	See Web

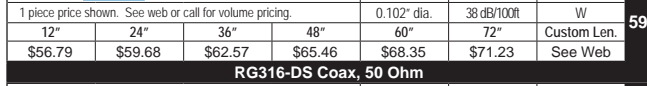

Standard Flexible Cable Assemblies

RG316-DS Coax, 50 Ohm						
Part No. PE3306	Cable Dia.			Attn. @ 1 GHz	Power @ 1 GHz	
1 piece price shown. See web or call for volume pricing.						
12"	24"	36"	48"	60"	72"	Custom Len.
\$56.79	\$59.68	\$62.57	\$65.46	\$68.35	\$71.23	See Web

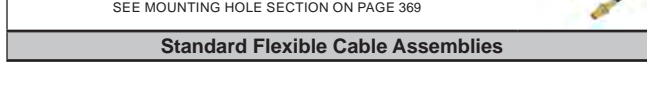

Standard Flexible Cable Assemblies

RG316-DS Coax, 50 Ohm						
Part No. PE37099	Cable Dia.			Attn. @ 1 GHz	Power @ 1 GHz	
1 piece price shown. See web or call for volume pricing.						
12"	24"	36"	48"	60"	-	Custom Len.
\$56.65	\$59.55	\$67.43	\$65.37	\$68.28	-	See Web

Cable Assemblies See Our Website For Current Pricing & Real-Time Stock Availability!

*Coax Performance at 1 GHz Notes: Cable assembly max frequency may be lower than connector or coax max frequency

For our complete selection of cable assemblies, please visit our website

RG174A/U Coax, 50 Ohm						
Part No. PE3W01300	Cable Dia.			Attn. @ 1 GHz	Power @ 1 GHz	
1 piece price shown. See web or call for volume pricing.	0.110" dia.			32 dB/100ft	17 W	
12"	24"	36"	48"	60"	50CM	Custom Len.
\$53.54	\$61.03	\$61.59	\$62.15	\$62.71	\$60.82	See Web

MCX PLUG RIGHT ANGLE TO SMA MALE



Standard Formable Cable Assemblies

PE-SR405FLJ Coax, 50 Ohm						
Part No. PE3W07396	Cable Dia.			Attn. @ 1 GHz	Power @ 1 GHz	
1 piece price shown. See web or call for volume pricing.	0.105" dia.			20 dB/100ft	122 W	
12"	24"	36"	48"	60"	50CM	Custom Len.
\$95.17	\$104.12	\$113.07	\$122.03	\$130.91	\$100.91	See Web

MCX JACK TO MCX JACK



Standard Flexible Cable Assemblies

RG178B/U Coax, 50 Ohm						
Part No. PE3W00099	Cable Dia.			Attn. @ 1 GHz	Power @ 1 GHz	
1 piece price shown. See web or call for volume pricing.	0.072" dia.			44 dB/100ft	78 W	
12"	24"	36"	48"	60"	50CM	Custom Len.
\$68.42	\$69.54	\$70.67	\$71.81	\$72.94	\$69.14	See Web

MHV MALE TO MHV MALE



Standard Flexible Cable Assemblies

RG8A/U Coax, 50 Ohm						
Part No. PE3098	Cable Dia.			Attn. @ 1 GHz	Power @ 1 GHz	
1 piece price shown. See web or call for volume pricing.	0.405" dia.			8 dB/100ft	190 W	
12"	24"	36"	48"	60"	72"	Custom Len.
\$94.22	\$102.94	\$99.88	\$102.72	\$112.39	\$115.53	See Web

RG58C/U Coax, 50 Ohm						
Part No. PE3516	Cable Dia.			Attn. @ 1 GHz	Power @ 1 GHz	
1 piece price shown. See web or call for volume pricing.	0.195" dia.			20 dB/100ft	44 W	
12"	24"	36"	48"	60"	72"	Custom Len.
\$77.77	\$78.58	\$79.39	\$80.25	\$81.08	\$81.91	See Web

RG141A/U Coax, 50 Ohm						
Part No. PE34429	Cable Dia.			Attn. @ 1 GHz	Power @ 1 GHz	
1 piece price shown. See web or call for volume pricing.	0.190" dia.			13 dB/100ft	650 W	
12"	24"	36"	48"	60"	72"	Custom Len.
\$85.59	\$92.05	\$104.53	\$111.84	\$118.87	\$117.87	See Web

RG142B/U Coax, 50 Ohm						
Part No. PE3914	Cable Dia.			Attn. @ 1 GHz	Power @ 1 GHz	
1 piece price shown. See web or call for volume pricing.	0.195" dia.			13 dB/100ft	W	
12"	24"	36"	48"	60"	72"	Custom Len.
\$59.09	\$64.81	\$70.55	\$75.04	\$82.01	\$87.42	See Web

RG174A/U Coax, 50 Ohm						
Part No. PE34427	Cable Dia.			Attn. @ 1 GHz	Power @ 1 GHz	
1 piece price shown. See web or call for volume pricing.	0.100" dia.			32 dB/100ft	16 W	
12"	24"	36"	48"	60"	72"	Custom Len.
\$98.06	\$98.50	\$103.14	\$99.37	\$104.34	\$104.93	See Web

RG188A/U Coax, 50 Ohm						
Part No. PE34431	Cable Dia.			Attn. @ 1 GHz	Power @ 1 GHz	
1 piece price shown. See web or call for volume pricing.	0.110" dia.			26 dB/100ft	160 W	
12"	24"	36"	48"	60"	72"	Custom Len.
\$101.72	\$103.94	\$106.15	\$108.38	\$110.60	\$112.81	See Web

RG214/U Coax, 50 Ohm						
Part No. PE3735	Cable Dia.			Attn. @ 1 GHz	Power @ 1 GHz	
1 piece price shown. See web or call for volume pricing.	0.425" dia.			7 dB/100ft	190 W	
12"	24"	36"	48"	60"	72"	Custom Len.
\$106.80	\$108.08	\$122.35	\$122.74	\$130.06	\$137.38	See Web

RG223/U Coax, 50 Ohm						
Part No. PE3694	Cable Dia.			Attn. @ 1 GHz	Power @ 1 GHz	
1 piece price shown. See web or call for volume pricing.	0.210" dia.			13 dB/100ft	53 W	
12"	24"	36"	48"	60"	72"	Custom Len.
\$59.61	\$59.13	\$62.03	\$69.12	\$67.83	\$75.47	See Web

RG225/U Coax, 50 Ohm						
Part No. PE34423	Cable Dia.			Attn. @ 1 GHz	Power @ 1 GHz	
1 piece price shown. See web or call for volume pricing.	0.430" dia.			dB/100ft	1700 W	
12"	24"	36"	48"	60"	72"	Custom Len.
\$118.49	\$151.08	\$183.66	\$216.26	\$248.85	\$281.43	See Web

RG393/U Coax, 50 Ohm						
Part No. PE3577	Cable Dia.			Attn. @ 1 GHz	Power @ 1 GHz	
1 piece price shown. See web or call for volume pricing.	0.390" dia.			9 dB/100ft	1700 W	
12"	24"	36"	48"	60"	72"	Custom Len.
\$107.60	\$130.46	\$138.53	\$154.00	\$169.46	\$184.93	See Web

RG400/U Coax, 50 Ohm						
Part No. PE3108	Cable Dia.			Attn. @ 1 GHz	Power @ 1 GHz	
1 piece price shown. See web or call for volume pricing.	0.242" dia.			12 dB/100ft	77 W	
12"	24"	36"	48"	60"	72"	Custom Len.
\$73.95	\$74.98	\$70.39	\$77.12	\$72.30	\$79.23	See Web

RG59B/U Coax, 75 Ohm						
Part No. PE34425	Cable Dia.			Attn. @ 1 GHz	Power @ 1 GHz	
1 piece price shown. See web or call for volume pricing.	0.195" dia.			15 dB/100ft	650 W	
12"	24"	36"	48"	60"	72"	Custom Len.
\$67.18	\$74.15	\$81.13	\$88.09	\$95.06	\$108.91	See Web

RG62A/U Coax, 93 Ohm						
Part No. PE3542	Cable Dia.			Attn. @ 1 GHz	Power @ 1 GHz	
1 piece price shown. See web or call for volume pricing.	0.242" dia.			12 dB/100ft	77 W	
12"	24"	36"	48"	60"	72"	Custom Len.
\$45.40	\$50.08	\$51.11	\$48.28	\$53.27	\$54.33	See Web

RG59B/U Coax, 75 Ohm						
Part No. PE3517	Cable Dia.			Attn. @ 1 GHz	Power @ 1 GHz	
1 piece price shown. See web or call for volume pricing.	0.242" dia.			13 dB/100ft	77 W	
12"	24"	36"	48"	60"	72"	Custom Len.
\$48.60	\$50.14	\$51.68	\$49.97	\$51.35	\$56.46	See Web

RG174A/U Coax, 50 Ohm						
Part No. PE35799	Cable Dia.			Attn. @ 1 GHz	Power @ 1 GHz	
1 piece price shown. See web or call for volume pricing.	0.100" dia.			32 dB/100ft	16 W	
12"	24"	36"	48"	60"	-	Custom Len.
\$102.79	\$103.37	\$103.94	\$98.27	\$98.71	-	See Web

RG8A/U Coax, 50 Ohm						
Part No. PE3365	Cable Dia.			Attn. @ 1 GHz	Power @ 1 GHz	
1 piece price shown. See web or call for volume pricing.	0.405" dia.			8 dB/100ft	190 W	
12"	24"	36"	48"	60"	72"	Custom Len.
\$95.72	\$98.56	\$101.39	\$104.22	\$107.05	\$109.88	See Web

RG58C/U Coax, 50 Ohm						
Part No. PE3950	Cable Dia.			Attn. @ 1 GHz	Power @ 1 GHz	
1 piece price shown. See web or call for volume pricing.	0.195" dia.			20 dB/100ft	44 W	
12"	24"	36"	48"	60"	72"	Custom Len.
\$88.97	\$96.90	\$97.72	\$91.17	\$99.40	\$100.23	See Web

RG141A/U Coax, 50 Ohm						
Part No. PE34413	Cable Dia.			Attn. @ 1 GHz	Power @ 1 GHz	
1 piece price shown. See web or call for volume pricing.	0.190" dia.			13 dB/100ft	650 W	
12"	24"	36"	48"	60"	72"	Custom Len.
\$94.17	\$100.63	\$117.40	\$124.70	\$119.99	\$126.46	See Web

RG142B/U Coax, 50 Ohm						
Part No. PE3085	Cable Dia.			Attn. @ 1 GHz	Power @ 1 GHz	
1 piece price shown. See web or call for volume pricing.	0.195" dia.			13 dB/100ft	W	
12"	24"	36"	48"	60"	72"	Custom Len.
\$87.66	\$93.40	\$99.12	\$104.85	\$110.58	\$123.90	See Web

RG174A/U Coax, 50 Ohm						
Part No. PE34419	Cable Dia.			Attn. @ 1 GHz	Power @ 1 GHz	
1 piece price shown. See web or call for volume pricing.	0.100" dia.			32 dB/100ft	16 W	
12"	24"	36"	48"	60"	72"	Custom Len.
\$102.68	\$97.31	\$103.85	\$98.21	\$98.62	\$99.10	See Web

RG188A/U Coax, 50 Ohm						
Part No. PE34415	Cable Dia.			Attn. @ 1 GHz	Power @ 1 GHz	
1 piece price shown. See web or call for volume pricing.	0.110" dia.			26 dB/100ft	160 W	
12"	24"	36"	48"	60"	72"	Custom Len.
\$98.57	\$100.73	\$102.82	\$104.99	\$107.10	\$109.24	See Web

RG214/U Coax, 50 Ohm						
Part No. PE33516	Cable Dia.			Attn. @ 1 GHz	Power @ 1 GHz	
1 piece price shown. See web or call for volume pricing.	0.425" dia.			7 dB/100ft	190 W	
12"	24"	36"	48"	60"	72"	Custom Len.
\$108.40	\$109.59	\$116.92	\$124.23	\$140.12	\$138.89	See Web

RG223/U Coax, 50 Ohm						
Part No. PE34411	Cable Dia.			Attn. @ 1 GHz	Power @ 1 GHz	
1 piece price shown. See web or call for volume pricing.	0.210" dia.			13 dB/100ft	53 W	
12"	24"	36"	48"	60"	72"	Custom Len.
\$72.16	\$75.07	\$82.71	\$80.87	\$83.75	\$92.36	See Web

RG393/U Coax, 50 Ohm						
Part No. PE33984	Cable Dia.			Attn. @ 1 GHz	Power @ 1 GHz	
1 piece price shown. See web or call for volume pricing.	0.390" dia.			8 dB/100ft	1700 W	
12"	24"	36"	48"	60"	72"	Custom Len.
\$110.22	\$125.68	\$141.15	\$156.62	\$172.08	\$187.55	See Web

RG400/U Coax, 50 Ohm						
Part No. PE34409	Cable Dia.			Attn. @ 1 GHz	Power @ 1 GHz	
1 piece price shown. See web or call for volume pricing.	0.195" dia.			15 dB/100ft	650 W	
12"	24"	36"	48"	60"	72"	Custom Len.
\$76.91	\$83.92	\$90.95	\$97.97	\$104.99	\$119.21	See Web

RG59B/U Coax, 75 Ohm						
Part No. PE3108	Cable Dia.			Attn. @ 1 GHz	Power @ 1 GHz	
1 piece price shown. See web or call for volume pricing.	0.242" dia.			12 dB/100ft	77 W	
12"	24"	36"	48"	60"	72"	Custom Len.
\$73.95	\$74.98	\$70.39	\$77.12	\$72.30	\$79.23	See Web

Cable Assemblies

See Our Website For Current Pricing & Real-Time Stock Availability!

For Custom Lengths, Metric Lengths or Special Configurations, Please call (949) 261-1920

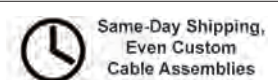

For our complete selection of cable assemblies, please visit our website

RG62A/U Coax, 93 Ohm						
Part No. PE3451	Cable Dia.	Attn. @ 1 GHz	Power @ 1 GHz			
1 piece price shown. See web or call for volume pricing.						
12"	24"	36"	48"	60"	72"	Custom Len.
\$67.66	\$69.03	\$70.41	\$71.77	\$73.15	\$74.53	See Web

MINI UHF MALE TO MINI UHF MALE



Standard Flexible Cable Assemblies

RG58C/U Coax, 50 Ohm						
Part No. PE3258	Cable Dia.	Attn. @ 1 GHz	Power @ 1 GHz			
1 piece price shown. See web or call for volume pricing.						
12"	24"	36"	48"	60"	72"	Custom Len.
\$32.12	\$32.85	\$33.59	\$34.33	\$38.64	\$35.79	See Web

RG142B/U Coax, 50 Ohm						
Part No. PE3263	Cable Dia.	Attn. @ 1 GHz	Power @ 1 GHz			
1 piece price shown. See web or call for volume pricing.						
12"	24"	36"	48"	60"	72"	Custom Len.
\$32.04	\$35.19	\$40.77	\$46.29	\$51.88	\$57.39	See Web

RG223/U Coax, 50 Ohm						
Part No. PE3265	Cable Dia.	Attn. @ 1 GHz	Power @ 1 GHz			
1 piece price shown. See web or call for volume pricing.						
12"	24"	36"	48"	60"	72"	Custom Len.
\$27.02	\$29.98	\$35.96	\$35.79	\$38.73	\$41.62	See Web

RG400/U Coax, 50 Ohm						
Part No. PE3269	Cable Dia.	Attn. @ 1 GHz	Power @ 1 GHz			
1 piece price shown. See web or call for volume pricing.						
12"	24"	36"	48"	60"	72"	Custom Len.
\$37.18	\$44.20	\$51.21	\$58.23	\$65.27	\$72.28	See Web

MMCX PLUG TO MMCX PLUG



Standard Flexible Cable Assemblies

RG174A/U Coax, 50 Ohm						
Part No. PE34879	Cable Dia.	Attn. @ 1 GHz	Power @ 1 GHz			
1 piece price shown. See web or call for volume pricing.						
12"	24"	36"	48"	60"	72"	Custom Len.
\$58.36	\$54.47	\$59.51	\$55.35	\$55.78	\$56.22	See Web

RG178B/U Coax, 50 Ohm						
Part No. PE34598	Cable Dia.	Attn. @ 1 GHz	Power @ 1 GHz			
1 piece price shown. See web or call for volume pricing.						
12"	24"	36"	48"	60"	72"	Custom Len.
\$59.15	\$60.20	\$55.69	\$56.65	\$57.60	\$58.57	See Web

RG188A/U Coax, 50 Ohm						
Part No. PE34599	Cable Dia.	Attn. @ 1 GHz	Power @ 1 GHz			
1 piece price shown. See web or call for volume pricing.						
4"	-	-	-	-	-	Custom Len.
\$88.57	-	-	-	-	-	See Web

RG188A/U Coax, 50 Ohm						
Part No. PE34885	Cable Dia.	Attn. @ 1 GHz	Power @ 1 GHz			
1 piece price shown. See web or call for volume pricing.						
12"	24"	36"	48"	60"	72"	Custom Len.
\$50.81	\$52.96	\$55.06	\$57.21	\$59.32	\$61.49	See Web

RG196A/U Coax, 50 Ohm						
Part No. PE34891	Cable Dia.	Attn. @ 1 GHz	Power @ 1 GHz			
1 piece price shown. See web or call for volume pricing.						
12"	24"	36"	48"	60"	72"	Custom Len.
\$49.23	\$50.57	\$51.88	\$53.21	\$54.51	\$55.84	See Web

RG316/U Coax, 50 Ohm						
Part No. PE34240	Cable Dia.	Attn. @ 1 GHz	Power @ 1 GHz			
1 piece price shown. See web or call for volume pricing.						
12"	24"	36"	48"	60"	72"	Custom Len.
\$56.21	\$59.34	\$62.57	\$65.46	\$68.35	\$71.23	See Web

RG316-DS Coax, 50 Ohm						
Part No. PE38679	Cable Dia.	Attn. @ 1 GHz	Power @ 1 GHz			
1 piece price shown. See web or call for volume pricing.						
12"	24"	36"	48"	60"	-	Custom Len.
\$51.63	\$54.53	\$57.44	\$60.36	\$63.26	-	See Web

MMCX PLUG TO MMCX PLUG RIGHT ANGLE



Low Loss Flexible Cable Assemblies

PE-C100-LSZH Coax, 50 Ohm						
Part No. PE38231	Cable Dia.	Attn. @ 1 GHz	Power @ 1 GHz			
1 piece price shown. See web or call for volume pricing.						
12"	24"	36"	48"	60"	-	Custom Len.
\$48.54	\$49.74	\$50.94	\$52.16	\$53.35	-	See Web

Standard Formable Cable Assemblies

PE-SR047FL Coax, 50 Ohm						
-------------------------	--	--	--	--	--	--

Part No. PE38322				Cable Dia.	Attn. @ 1 GHz	Power @ 1 GHz
1 piece price shown. See web or call for volume pricing.						
12"	24"	36"	48"	0.047" dia.	36 dB/100ft	32 W
\$82.37	\$85.08	\$92.44	\$99.82	\$107.18	-	Custom Len.
						See Web

Standard Flexible Cable Assemblies

RG174A/U Coax, 50 Ohm						
Part No. PE34881	Cable Dia.	Attn. @ 1 GHz	Power @ 1 GHz			
1 piece price shown. See web or call for volume pricing.						
12"	24"	36"	48"	0.100" dia.	32 dB/100ft	16 W
\$61.71	\$62.29	\$58.02	\$58.44	\$58.88	\$59.32	See Web

RG178B/U Coax, 50 Ohm						
Part No. PE34883	Cable Dia.	Attn. @ 1 GHz	Power @ 1 GHz			
1 piece price shown. See web or call for volume pricing.						
12"	24"	36"	48"	0.072" dia.	44 dB/100ft	78 W
\$62.23	\$63.18	\$63.14	\$65.10	\$66.06	\$67.02	See Web

RG188A/U Coax, 50 Ohm						
Part No. PE34889	Cable Dia.	Attn. @ 1 GHz	Power @ 1 GHz			
1 piece price shown. See web or call for volume pricing.						
12"	24"	36"	48"	0.110" dia.	26 dB/100ft	160 W
\$58.98	\$67.38	\$63.43	\$65.64	\$67.87	\$70.08	See Web

RG196A/U Coax, 50 Ohm						
Part No. PE34893	Cable Dia.	Attn. @ 1 GHz	Power @ 1 GHz			
1 piece price shown. See web or call for volume pricing.						
12"	24"	36"	48"	0.080" dia.	49 dB/100ft	78 W
\$56.92	\$58.23	\$59.57	\$60.89	\$62.20	\$63.52	See Web

RG316/U Coax, 50 Ohm						
Part No. PE34895	Cable Dia.	Attn. @ 1 GHz	Power @ 1 GHz			
1 piece price shown. See web or call for volume pricing.						
12"	24"	36"	48"	0.098" dia.	38 dB/100ft	160 W
\$65.89	\$69.01	\$65.68	\$68.56	\$71.46	\$74.34	See Web

MMCX PLUG TO N FEMALE BULKHEAD

SEE MOUNTING HOLE SECTION ON PAGE 369



Formable Cable Assemblies

PE-SR047FL Coax, 50 Ohm						
Part No. PE3W07591	Cable Dia.	Attn. @ 1 GHz	Power @ 1 GHz			
1 piece price shown. See web or call for volume pricing.						
12"	24"	36"	48"	. dia.	36 dB/100ft	32 W
\$87.48	\$96.15	\$104.82	\$113.50	\$122.18	\$93.04	See Web

MMCX PLUG TO SMC PLUG



Standard Flexible Cable Assemblies

RG178B/U Coax, 50 Ohm						
Part No. PE3W07653	Cable Dia.	Attn. @ 1 GHz	Power @ 1 GHz			
1 piece price shown. See web or call for volume pricing.						
12"	24"	36"	48"	0.072" dia.	44 dB/100ft	55 W
\$48.52	\$49.64	\$50.78	\$51.91	\$53.04	\$49.24	See Web

MMCX PLUG RIGHT ANGLE TO BNC FEMALE BULKHEAD

SEE MOUNTING HOLE SECTION ON PAGE 369



Standard Flexible Cable Assemblies

RG174A/U Coax, 50 Ohm						
Part No. PE36738	Cable Dia.	Attn. @ 1 GHz	Power @ 1 GHz			
1 piece price shown. See web or call for volume pricing.						
12"	24"	36"	48"	0.100" dia.	32 dB/100ft	16 W
\$58.10	\$58.67	\$59.25	\$56.12	\$60.45	-	See Web

MMCX PLUG RIGHT ANGLE TO MMCX PLUG



Standard Formable Cable Assemblies

PE-SR405FLJ Coax, 50 Ohm						
Part No. PE3W05483	Cable Dia.	Attn. @ 1 GHz	Power @ 1 GHz			
1 piece price shown. See web or call for volume pricing.						
12"	24"	36"	48"	0.105" dia.	20 dB/100ft	122 W
\$52.83	\$73.36	\$82.32	\$91.28	\$100.23	\$70.15	See Web

MMCX PLUG RIGHT ANGLE TO SMA MALE RIGHT ANGLE



Standard Flexible Cable Assemblies

RG316/U Coax, 50 Ohm						
Part No. PE3W07894	Cable Dia.	Attn. @ 1 GHz	Power @ 1 GHz			
1 piece price shown. See web or call for volume pricing.						
12"	18"	24"	36"	0.102" dia.	38 dB/100ft	W
\$70.20	\$71.78	\$73.36	\$76.52	\$79.68	\$82.84	See Web

Cable Assemblies

See Our Website For Current Pricing & Real-Time Stock Availability!

*Coax Performance at 1 GHz Notes: Cable assembly max frequency may be lower than connector or coax max frequency

For our complete selection of cable assemblies, please visit our website

MMCX PLUG RIGHT ANGLE TO SMA FEMALE						
Standard Flexible Cable Assemblies						
RG188-DS Coax, 50 Ohm						
Part No. PE3W07068		Cable Dia.	Attn. @ 1 GHz	Power @ 1 GHz		
1 piece price shown. See web or call for volume pricing.		0.118" dia.	30 dB/100ft	160 W		
12"	24"	36"	48"	60"	50CM	Custom Len.
\$59.70	Call	Call	Call	Call	Call	See Web
Standard Formable Cable Assemblies						
PE-SR405FLJ Coax, 50 Ohm						
Part No. PE3C4064		Cable Dia.	Attn. @ 1 GHz	Power @ 1 GHz		
1 piece price shown. See web or call for volume pricing.		0.098" dia.	20 dB/100ft	122 W		
4"	6"	8"	12"	18"	24"	Custom Len.
\$50.10	\$51.36	\$52.61	\$60.64	\$58.88	\$62.65	See Web
Standard Flexible Cable Assemblies						
RG178B/U Coax, 50 Ohm						
Part No. PE3C3985		Cable Dia.	Attn. @ 1 GHz	Power @ 1 GHz		
1 piece price shown. See web or call for volume pricing.		0.072" dia.	44 dB/100ft	55 W		
4"	6"	8"	12"	18"	24"	Custom Len.
\$44.78	\$44.94	\$45.09	\$45.41	\$45.87	\$46.34	See Web
Standard Flexible Cable Assemblies						
RG316-DS Coax, 50 Ohm						
Part No. PE3C4048		Cable Dia.	Attn. @ 1 GHz	Power @ 1 GHz		
1 piece price shown. See web or call for volume pricing.		0.114" dia.	9 dB/100ft	85 W		
4"	6"	8"	12"	18"	24"	Custom Len.
\$45.43	\$45.88	\$46.36	\$47.31	\$48.71	\$50.13	See Web
Standard Flexible Cable Assemblies						
RG178B/U Coax, 50 Ohm						
Part No. PE3C3986		Cable Dia.	Attn. @ 1 GHz	Power @ 1 GHz		
1 piece price shown. See web or call for volume pricing.		0.072" dia.	44 dB/100ft	55 W		
4"	6"	8"	12"	18"	24"	Custom Len.
\$48.57	\$48.72	\$48.88	\$49.20	\$49.66	\$50.13	See Web
Standard Formable Cable Assemblies						
PE-SR405FLJ Coax, 50 Ohm						
Part No. PE3C4068		Cable Dia.	Attn. @ 1 GHz	Power @ 1 GHz		
1 piece price shown. See web or call for volume pricing.		0.098" dia.	20 dB/100ft	122 W		
4"	6"	8"	12"	18"	24"	Custom Len.
\$49.14	\$45.94	\$47.20	\$49.71	\$53.47	\$57.24	See Web
Standard Flexible Cable Assemblies						
RG174A/U Coax, 50 Ohm						
Part No. PE3C4036		Cable Dia.	Attn. @ 1 GHz	Power @ 1 GHz		
1 piece price shown. See web or call for volume pricing.		0.110" dia.	32 dB/100ft	17 W		
4"	6"	8"	12"	18"	24"	Custom Len.
\$41.99	\$42.06	\$42.13	\$42.27	\$42.47	\$47.07	See Web
Standard Flexible Cable Assemblies						
RG178B/U Coax, 50 Ohm						
Part No. PE3C3989		Cable Dia.	Attn. @ 1 GHz	Power @ 1 GHz		
1 piece price shown. See web or call for volume pricing.		0.072" dia.	44 dB/100ft	55 W		
4"	6"	8"	12"	18"	24"	Custom Len.
\$49.73	\$49.88	\$50.05	\$50.36	\$50.83	\$51.29	See Web
Standard Flexible Cable Assemblies						
RG316/U Coax, 50 Ohm						
Part No. PE3C4019		Cable Dia.	Attn. @ 1 GHz	Power @ 1 GHz		
1 piece price shown. See web or call for volume pricing.		0.098" dia.	58 dB/100ft	160 W		
4"	6"	8"	12"	18"	24"	Custom Len.
\$42.78	\$43.24	\$43.71	\$44.66	\$46.05	\$52.25	See Web
Standard Flexible Cable Assemblies						
RG316-DS Coax, 50 Ohm						
Part No. PE3C3854		Cable Dia.	Attn. @ 1 GHz	Power @ 1 GHz		
1 piece price shown. See web or call for volume pricing.		0.114" dia.	9 dB/100ft	85 W		
4"	6"	8"	12"	18"	24"	Custom Len.
\$38.05	\$38.52	\$38.99	\$39.93	\$41.34	\$42.75	See Web
Standard Flexible Cable Assemblies						
RG316/U Coax, 50 Ohm						
Part No. PE3C4027		Cable Dia.	Attn. @ 1 GHz	Power @ 1 GHz		
1 piece price shown. See web or call for volume pricing.		0.098" dia.	58 dB/100ft	160 W		
4"	6"	8"	12"	18"	24"	Custom Len.
\$52.75	\$53.22	\$53.69	\$54.62	\$56.02	\$57.42	See Web

RG316-DS Coax, 50 Ohm						
Part No. PE3C4060		Cable Dia.	Attn. @ 1 GHz	Power @ 1 GHz		
1 piece price shown. See web or call for volume pricing.		0.114" dia.	9 dB/100ft	85 W		
4"	6"	8"	12"	18"	24"	Custom Len.
\$51.34	\$51.79	\$52.27	\$53.22	\$54.62	\$56.04	See Web
Standard Flexible Cable Assemblies						
RG316/U Coax, 50 Ohm						
Part No. PE3C4029		Cable Dia.	Attn. @ 1 GHz	Power @ 1 GHz		
1 piece price shown. See web or call for volume pricing.		0.098" dia.	58 dB/100ft	160 W		
4"	6"	8"	12"	18"	24"	Custom Len.
\$51.99	\$52.46	\$52.93	\$59.24	\$55.26	\$56.66	See Web
Standard Flexible Cable Assemblies						
RG316-DS Coax, 50 Ohm						
Part No. PE3C4062		Cable Dia.	Attn. @ 1 GHz	Power @ 1 GHz		
1 piece price shown. See web or call for volume pricing.		0.114" dia.	9 dB/100ft	85 W		
4"	6"	8"	12"	18"	24"	Custom Len.
\$51.33	\$51.78	\$52.26	\$53.21	\$54.61	\$56.03	See Web
Standard Formable Cable Assemblies						
PE-SR405FLJ Coax, 50 Ohm						
Part No. PE3C4066		Cable Dia.	Attn. @ 1 GHz	Power @ 1 GHz		
1 piece price shown. See web or call for volume pricing.		0.098" dia.	20 dB/100ft	122 W		
4"	6"	8"	12"	18"	24"	Custom Len.
\$52.02	\$48.55	\$49.81	\$52.31	\$56.07	\$59.85	See Web
Standard Flexible Cable Assemblies						
RG174A/U Coax, 50 Ohm						
Part No. PE3C4034		Cable Dia.	Attn. @ 1 GHz	Power @ 1 GHz		
1 piece price shown. See web or call for volume pricing.		0.110" dia.	32 dB/100ft	17 W		
4"	6"	8"	12"	18"	24"	Custom Len.
\$47.35	\$47.41	\$47.49	\$47.63	\$52.68	\$48.05	See Web
Standard Flexible Cable Assemblies						
RG178B/U Coax, 50 Ohm						
Part No. PE3C3922		Cable Dia.	Attn. @ 1 GHz	Power @ 1 GHz		
1 piece price shown. See web or call for volume pricing.		0.072" dia.	44 dB/100ft	55 W		
4"	6"	8"	12"	18"	24"	Custom Len.
\$52.61	\$52.76	\$52.93	\$53.24	\$53.79	\$54.17	See Web
Standard Flexible Cable Assemblies						
RG316/U Coax, 50 Ohm						
Part No. PE3W07532		Cable Dia.	Attn. @ 1 GHz	Power @ 1 GHz		
1 piece price shown. See web or call for volume pricing.		0.102" dia.	38 dB/100ft	W		
12"	24"	36"	48"	60"	50CM	Custom Len.
\$69.15	\$72.42	\$75.70	\$78.98	\$82.27	\$71.24	See Web
Standard Flexible Cable Assemblies						
RG178B/U Coax, 50 Ohm						
Part No. PE3C3995		Cable Dia.	Attn. @ 1 GHz	Power @ 1 GHz		
1 piece price shown. See web or call for volume pricing.		0.072" dia.	44 dB/100ft	55 W		
4"	6"	8"	12"	18"	24"	Custom Len.
\$56.38	\$53.35	\$53.52	\$53.83	\$54.30	\$54.77	See Web
Standard Flexible Cable Assemblies						
RG316/U Coax, 50 Ohm						
Part No. PE3C4025		Cable Dia.	Attn. @ 1 GHz	Power @ 1 GHz		
1 piece price shown. See web or call for volume pricing.		0.098" dia.	58 dB/100ft	160 W		
4"	6"	8"	12"	18"	24"	Custom Len.
\$56.25	\$56.71	\$57.18	\$63.93	\$59.51	\$60.92	See Web
Standard Flexible Cable Assemblies						
RG178B/U Coax, 50 Ohm						
Part No. PE3C3987		Cable Dia.	Attn. @ 1 GHz	Power @ 1 GHz		
1 piece price shown. See web or call for volume pricing.		0.072" dia.	44 dB/100ft	55 W		
4"	6"	8"	12"	18"	24"	Custom Len.
\$52.37	\$52.51	\$52.68	\$52.99	\$53.46	\$53.92	See Web
Standard Flexible Cable Assemblies						
RG316/U Coax, 50 Ohm						
Part No. PE3C4016		Cable Dia.	Attn. @ 1 GHz	Power @ 1 GHz		
1 piece price shown. See web or call for volume pricing.		0.098" dia.	58 dB/100ft	160 W		
4"	6"	8"	12"	18"	24"	Custom Len.
\$52.99	\$53.46	\$53.92	\$60.35	\$56.26	\$57.65	See Web

Cable Assemblies

See Our Website For Current Pricing & Real-Time Stock Availability!

For Custom Lengths, Metric Lengths or Special Configurations, Please call (949) 261-1920

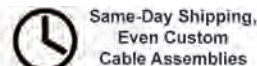
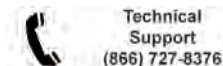

For our complete selection of cable assemblies, please visit our website

MMBX PLUG RIGHT ANGLE TO SMA MALE



Standard Formable Cable Assemblies

PE-SR405FLJ Coax, 50 Ohm

Part No. PE3C4069	Cable Dia.	Attn. @ 1 GHz	Power @ 1 GHz
1 piece price shown. See web or call for volume pricing.			
4"	6"	8"	12"
\$51.61	\$48.17	\$49.43	\$51.94
18"	24"	30"	36"
\$55.70	\$59.46	See Web	See Web

Standard Flexible Cable Assemblies

RG174A/U Coax, 50 Ohm

Part No. PE3C4037	Cable Dia.	Attn. @ 1 GHz	Power @ 1 GHz
1 piece price shown. See web or call for volume pricing.			
4"	6"	8"	12"
\$45.78	\$45.84	\$45.92	\$46.06
18"	24"	30"	36"
\$46.27	\$46.48	See Web	See Web

RG178B/U Coax, 50 Ohm

Part No. PE3C3990	Cable Dia.	Attn. @ 1 GHz	Power @ 1 GHz
1 piece price shown. See web or call for volume pricing.			
4"	6"	8"	12"
\$53.52	\$53.67	\$53.83	\$54.15
18"	24"	30"	36"
\$54.61	\$55.08	See Web	See Web

RG316/U Coax, 50 Ohm

Part No. PE3C4020	Cable Dia.	Attn. @ 1 GHz	Power @ 1 GHz
1 piece price shown. See web or call for volume pricing.			
4"	6"	8"	12"
\$84.37	\$84.48	\$84.62	\$89.96
18"	24"	30"	36"
\$85.23	\$93.08	See Web	See Web

RG316-DS Coax, 50 Ohm

Part No. PE3C4053	Cable Dia.	Attn. @ 1 GHz	Power @ 1 GHz
1 piece price shown. See web or call for volume pricing.			
4"	6"	8"	12"
\$41.84	\$42.31	\$42.78	\$43.72
18"	24"	30"	36"
\$49.65	\$46.55	See Web	See Web

MMBX PLUG RIGHT ANGLE TO SMA MALE RIGHT ANGLE



Standard Flexible Cable Assemblies

RG174A/U Coax, 50 Ohm

Part No. PE3C4045	Cable Dia.	Attn. @ 1 GHz	Power @ 1 GHz
1 piece price shown. See web or call for volume pricing.			
4"	6"	8"	12"
\$55.75	\$55.82	\$55.89	\$56.03
18"	24"	30"	36"
\$56.24	\$56.45	See Web	See Web

RG316/U Coax, 50 Ohm

Part No. PE3C4028	Cable Dia.	Attn. @ 1 GHz	Power @ 1 GHz
1 piece price shown. See web or call for volume pricing.			
4"	6"	8"	12"
\$56.54	\$57.01	\$57.47	\$58.41
18"	24"	30"	36"
\$59.82	\$61.21	See Web	See Web

MMBX PLUG RIGHT ANGLE TO SMA FEMALE



Standard Flexible Cable Assemblies

RG178B/U Coax, 50 Ohm

Part No. PE3W03154	Cable Dia.	Attn. @ 1 GHz	Power @ 1 GHz
1 piece price shown. See web or call for volume pricing.			
4"	6"	8"	12"
\$61.93	\$62.08	\$62.25	\$62.56
18"	24"	30"	36"
\$63.03	\$63.49	See Web	See Web

RG316/U Coax, 50 Ohm

Part No. PE3C4030	Cable Dia.	Attn. @ 1 GHz	Power @ 1 GHz
1 piece price shown. See web or call for volume pricing.			
4"	6"	8"	12"
\$61.39	\$61.90	\$56.71	\$57.65
18"	24"	30"	36"
\$59.06	\$60.45	See Web	See Web

RG316-DS Coax, 50 Ohm

Part No. PE3C4063	Cable Dia.	Attn. @ 1 GHz	Power @ 1 GHz
1 piece price shown. See web or call for volume pricing.			
4"	6"	8"	12"
\$60.68	\$55.58	\$56.05	\$57.00
18"	24"	30"	36"
\$58.40	\$59.83	See Web	See Web

MMBX PLUG RIGHT ANGLE TO SMA FEMALE BULKHEAD



SEE MOUNTING HOLE SECTION ON PAGE 369

Standard Formable Cable Assemblies

PE-SR405FLJ Coax, 50 Ohm

Part No. PE3C4067	Cable Dia.	Attn. @ 1 GHz	Power @ 1 GHz
1 piece price shown. See web or call for volume pricing.			
4"	6"	8"	12"
\$54.47	\$50.78	\$52.03	\$54.55
18"	24"	30"	36"
\$58.31	\$62.07	See Web	See Web

Standard Flexible Cable Assemblies

RG174A/U Coax, 50 Ohm

Part No. PE3C4035	Cable Dia.	Attn. @ 1 GHz	Power @ 1 GHz
1 piece price shown. See web or call for volume pricing.			
4"	6"	8"	12"
\$51.14	\$51.20	\$51.27	\$51.42
18"	24"	30"	36"
\$56.85	\$51.85	See Web	See Web

RG178B/U Coax, 50 Ohm

Part No. PE3C4807	Cable Dia.	Attn. @ 1 GHz	Power @ 1 GHz
1 piece price shown. See web or call for volume pricing.			
12"	24"	36"	48"
\$68.62	\$69.64	\$70.67	\$71.70
60"	50CM	55 W	Custom Len.
\$72.73	\$69.27	See Web	See Web

RG316/U Coax, 50 Ohm

Part No. PE3C4018	Cable Dia.	Attn. @ 1 GHz	Power @ 1 GHz
1 piece price shown. See web or call for volume pricing.			
4"	6"	8"	12"
\$57.04	\$57.04	\$57.04	\$57.04
18"	24"	30"	36"
\$58.47	\$59.92	See Web	See Web

RG316-DS Coax, 50 Ohm

Part No. PE3C4052	Cable Dia.	Attn. @ 1 GHz	Power @ 1 GHz
1 piece price shown. See web or call for volume pricing.			
4"	6"	8"	12"
\$58.02	\$58.47	\$58.95	\$59.90
18"	24"	30"	36"
\$61.30	\$62.72	See Web	See Web

MMBX PLUG RIGHT ANGLE TO REVERSE POLARITY SMA FEMALE BULKHEAD



SEE MOUNTING HOLE SECTION ON PAGE 369

Standard Flexible Cable Assemblies

RG178B/U Coax, 50 Ohm

Part No. PE3C3992	Cable Dia.	Attn. @ 1 GHz	Power @ 1 GHz
1 piece price shown. See web or call for volume pricing.			
4"	6"	8"	12"
\$49.75	\$45.38	\$45.54	\$45.85
18"	24"	30"	36"
\$46.32	\$46.79	See Web	See Web

RG316-DS Coax, 50 Ohm

Part No. PE3C4055	Cable Dia.	Attn. @ 1 GHz	Power @ 1 GHz
1 piece price shown. See web or call for volume pricing.			
4"	6"	8"	12"
\$62.14	\$62.60	\$63.08	\$64.02
18"	24"	30"	36"
\$65.43	\$66.85	See Web	See Web

MMBX PLUG RIGHT ANGLE TO TNC FEMALE BULKHEAD



SEE MOUNTING HOLE SECTION ON PAGE 369

Standard Flexible Cable Assemblies

RG174A/U Coax, 50 Ohm

Part No. PE3C4043	Cable Dia.	Attn. @ 1 GHz	Power @ 1 GHz
1 piece price shown. See web or call for volume pricing.			
4"	6"	8"	12"
\$59.24	\$59.32	\$59.39	\$65.48
18"	24"	30"	36"
\$65.77	\$59.95	See Web	See Web

RG178B/U Coax, 50 Ohm

Part No. PE3C3996	Cable Dia.	Attn. @ 1 GHz	Power @ 1 GHz
1 piece price shown. See web or call for volume pricing.			
4"	6"	8"	12"
\$62.70	\$57.15	\$57.31	\$57.62
18"	24"	30"	36"
\$58.09	\$58.56	See Web	See Web

RG316/U Coax, 50 Ohm

Part No. PE3C4026	Cable Dia.	Attn. @ 1 GHz	Power @ 1 GHz
1 piece price shown. See web or call for volume pricing.			
4"	6"	8"	12"
\$60.03	\$60.50	\$60.97	\$61.91
18"	24"	30"	36"
\$67.19	\$64.70	See Web	See Web

RG316-DS Coax, 50 Ohm

Part No. PE3C4059	Cable Dia.	Attn. @ 1 GHz	Power @ 1 GHz
1 piece price shown. See web or call for volume pricing.			
4"	6"	8"	12"
\$59.67	\$60.14	\$60.62	\$61.55
18"	24"	30"	36"
\$69.27	\$64.38	See Web	See Web

N MALE TO N MALE



Standard Flexible Cable Assemblies

M17/60-RG142-27478 Coax, 50 Ohm

Part No. PE3M0008	Cable Dia.	Attn. @ 1 GHz	Power @ 1 GHz
1 piece price shown. See web or call for volume pricing.			
12"	18"	24"	30"
\$151.97	\$154.70	\$157.43	\$160.15
36"	48"	60"	72"
\$162.88	\$168.34	See Web	See Web

M17/84-RG223-0XDS2 Coax, 50 Ohm

Part No. PE3M0036	Cable Dia.	Attn. @ 1 GHz	Power @ 1 GHz
1 piece price shown. See web or call for volume pricing.			
12"	18"	24"	30"
\$156.28	\$161.15	\$166.03	\$170.91
36"	48"	60"	72"
\$176.37	\$185.54	See Web	See Web

M17/128-RG400-27478 Coax, 50 Ohm

Part No. PE3M0064	Cable Dia.	Attn. @ 1 GHz	Power @ 1 GHz
1 piece price shown. See web or call for volume pricing.			
12"	18"	24"	30"
\$153.46	\$156.93	\$160.40	\$163.87
36"	48"	60"	72"
\$167.34	\$174.28	See Web	See Web

N MALE TO N FEMALE



Standard Flexible Cable Assemblies

M17/60-RG142-27478 Coax, 50 Ohm

*Coax Performance at 1 GHz Notes: Cable assembly max frequency may be lower than connector or coax max frequency

Cable Assemblies

See Our Website For Current Pricing & Real-Time Stock Availability!

For our complete selection of cable assemblies, please visit our website

Part No. PE3M0009	Cable Dia.	Attn. @ 1 GHz	Power @ 1 GHz
1 piece price shown. See web or call for volume pricing.	0.195" dia.	dB/100ft	W
12" 18" 24" 30"	36" 48"	48"	Custom Len.
\$161.55 \$164.28 \$167.01 \$169.73	\$172.46 \$177.92	See Web	
M17/84-RG223-0XDS2 Coax, 50 Ohm			
Part No. PE3M0037	Cable Dia.	Attn. @ 1 GHz	Power @ 1 GHz
1 piece price shown. See web or call for volume pricing.	0.212" dia.	dB/100ft	W
12" 18" 24" 30"	36" 48"	48"	Custom Len.
\$165.86 \$170.73 \$175.61 \$180.48	\$185.37 \$195.12	See Web	
M17/128-RG400-27478 Coax, 50 Ohm			
Part No. PE3M0065	Cable Dia.	Attn. @ 1 GHz	Power @ 1 GHz
1 piece price shown. See web or call for volume pricing.	0.195" dia.	dB/100ft	W
12" 18" 24" 30"	36" 48"	48"	Custom Len.
\$163.04 \$166.51 \$169.98 \$173.45	\$176.92 \$183.86	See Web	

Part No. PE3M0016	Cable Dia.	Attn. @ 1 GHz	Power @ 1 GHz
1 piece price shown. See web or call for volume pricing.	0.195" dia.	dB/100ft	W
12" 18" 24" 30"	36" 48"	48"	Custom Len.
\$154.58 \$157.30 \$160.04 \$162.76	\$165.49 \$170.95	See Web	
M17/84-RG223-0XDS2 Coax, 50 Ohm			
Part No. PE3M0044	Cable Dia.	Attn. @ 1 GHz	Power @ 1 GHz
1 piece price shown. See web or call for volume pricing.	0.212" dia.	dB/100ft	W
12" 18" 24" 30"	36" 48"	48"	Custom Len.
\$158.88 \$163.76 \$168.64 \$173.51	\$178.40 \$188.15	See Web	
M17/128-RG400-27478 Coax, 50 Ohm			
Part No. PE3M0072	Cable Dia.	Attn. @ 1 GHz	Power @ 1 GHz
1 piece price shown. See web or call for volume pricing.	0.195" dia.	dB/100ft	W
12" 18" 24" 30"	36" 48"	48"	Custom Len.
\$156.07 \$159.54 \$163.01 \$166.48	\$169.95 \$176.89	See Web	

N MALE TO N FEMALE BULKHEAD
SEE MOUNTING HOLE SECTION ON PAGE 369



N MALE TO 4.1/9.5 MINI DIN MALE



Standard Flexible Cable Assemblies

Low PIM Corrugated Cable Assemblies

Part No. PE3M0010	Cable Dia.	Attn. @ 1 GHz	Power @ 1 GHz
1 piece price shown. See web or call for volume pricing.	0.195" dia.	dB/100ft	W
12" 18" 24" 30"	36" 48"	48"	Custom Len.
\$165.40 \$168.12 \$170.85 \$173.58	\$176.31 \$181.76	See Web	
M17/84-RG223-0XDS2 Coax, 50 Ohm			
Part No. PE3M0038	Cable Dia.	Attn. @ 1 GHz	Power @ 1 GHz
1 piece price shown. See web or call for volume pricing.	0.212" dia.	dB/100ft	W
12" 18" 24" 30"	36" 48"	48"	Custom Len.
\$169.70 \$174.57 \$179.46 \$184.33	\$189.21 \$198.97	See Web	
M17/128-RG400-27478 Coax, 50 Ohm			
Part No. PE3M0066	Cable Dia.	Attn. @ 1 GHz	Power @ 1 GHz
1 piece price shown. See web or call for volume pricing.	0.195" dia.	dB/100ft	W
12" 18" 24" 30"	36" 48"	48"	Custom Len.
\$166.88 \$170.32 \$173.82 \$177.29	\$180.77 \$187.71	See Web	

Part No. PE3C4140	Cable Dia.	Attn. @ 1 GHz	Power @ 1 GHz
1 piece price shown. See web or call for volume pricing.	0.280" dia.	dB/100ft	W
12" 24" 36" 48"	60" 50CM	48"	Custom Len.
\$90.05 \$95.63 \$101.21 \$106.79	\$112.37 \$93.62	See Web	

N MALE TO SMA MALE



N MALE TO 7/16 DIN MALE



Standard Flexible Cable Assemblies

Low Loss Formable Cable Assemblies

Part No. PE3M0014	Cable Dia.	Attn. @ 1 GHz	Power @ 1 GHz
1 piece price shown. See web or call for volume pricing.	0.195" dia.	dB/100ft	W
12" 18" 24" 30"	36" 48"	48"	Custom Len.
\$185.30 \$188.02 \$190.75 \$193.47	\$196.20 \$201.66	See Web	
M17/84-RG223-0XDS2 Coax, 50 Ohm			
Part No. PE3M0042	Cable Dia.	Attn. @ 1 GHz	Power @ 1 GHz
1 piece price shown. See web or call for volume pricing.	0.212" dia.	dB/100ft	W
12" 18" 24" 30"	36" 48"	48"	Custom Len.
\$189.60 \$194.47 \$199.35 \$204.23	\$209.11 \$218.87	See Web	
M17/128-RG400-27478 Coax, 50 Ohm			
Part No. PE3M0070	Cable Dia.	Attn. @ 1 GHz	Power @ 1 GHz
1 piece price shown. See web or call for volume pricing.	0.195" dia.	dB/100ft	W
12" 18" 24" 30"	36" 48"	48"	Custom Len.
\$186.78 \$190.25 \$193.72 \$197.19	\$200.66 \$207.60	See Web	

Part No. PE3C0143	Cable Dia.	Attn. @ 1 GHz	Power @ 1 GHz
1 piece price shown. See web or call for volume pricing.	0.450" dia.	3 dB/100ft	W
12" 24" 36" 48"	60"	50CM	Custom Len.
\$79.18 \$81.47 \$83.74 \$86.02	\$88.32 -	See Web	

N MALE TO SMA MALE RIGHT ANGLE



Low Loss Flexible Cable Assemblies

Standard Flexible Cable Assemblies

PE-C600 Coax, 50 Ohm

Part No. PE3M0015	Cable Dia.	Attn. @ 1 GHz	Power @ 1 GHz
1 piece price shown. See web or call for volume pricing.	0.195" dia.	dB/100ft	W
12" 18" 24" 30"	36" 48"	48"	Custom Len.
\$221.38 \$224.10 \$226.83 \$229.56	\$232.29 \$238.56	See Web	
M17/84-RG223-0XDS2 Coax, 50 Ohm			
Part No. PE3M0043	Cable Dia.	Attn. @ 1 GHz	Power @ 1 GHz
1 piece price shown. See web or call for volume pricing.	0.212" dia.	dB/100ft	W
12" 18" 24" 30"	36" 48"	48"	Custom Len.
\$225.68 \$230.55 \$235.44 \$240.31	\$245.19 \$254.95	See Web	
M17/128-RG400-27478 Coax, 50 Ohm			
Part No. PE3M0071	Cable Dia.	Attn. @ 1 GHz	Power @ 1 GHz
1 piece price shown. See web or call for volume pricing.	0.195" dia.	dB/100ft	W
12" 18" 24" 30"	36" 48"	48"	Custom Len.
\$222.87 \$226.33 \$229.81 \$233.27	\$236.75 \$243.69	See Web	

Part No. PE38436	Cable Dia.	Attn. @ 1 GHz	Power @ 1 GHz
1 piece price shown. See web or call for volume pricing.	0.590" dia.	3 dB/100ft	900 W
36" 48" 60" 72"	120"	-	Custom Len.
\$121.97 \$127.85 \$133.73 \$137.59	\$163.14 -	See Web	

N MALE TO TNC MALE



Part No. PE3W03803	Cable Dia.	Attn. @ 1 GHz	Power @ 1 GHz
1 piece price shown. See web or call for volume pricing.	0.405" dia.	4 dB/100ft	W
12" 24" 36" 48"	60" 50CM	48"	Custom Len.
\$85.27 \$86.61 \$87.95 \$89.29	\$90.63 \$86.13	See Web	

Low PIM Formable Cable Assemblies

PE-SR401FLJ Low PIM Coax, 50 Ohm

Part No. PE3C2012	Cable Dia.	Attn. @ 1 GHz	Power @ 1 GHz
1 piece price shown. See web or call for volume pricing.	0.276" dia.	dB/100ft	W
100CM 200CM	-	-	Custom Len.
\$153.56 \$185.37	-	-	See Web

Part No. PE3C2002	Cable Dia.	Attn. @ 1 GHz	Power @ 1 GHz
1 piece price shown. See web or call for volume pricing.	0.161" dia.	dB/100ft	W
100CM 200CM	-	-	Custom Len.
\$111.81 \$134.70	-	-	See Web

Low PIM Corrugated Cable Assemblies

SPP-250-LLPL Coax, 50 Ohm

Part No. PE3C4132	Cable Dia.	Attn. @ 1 GHz	Power @ 1 GHz
1 piece price shown. See web or call for volume pricing.	0.280" dia.	dB/100ft	W
12" 24" 36" 48"	60" 50CM	48"	Custom Len.
\$92.38 \$97.96 \$103.54 \$109.12	\$114.70 \$95.95	See Web	

Standard Formable Cable Assemblies

PE-SR401FL Coax, 50 Ohm

Part No. PE36178	Cable Dia.	Attn. @ 1 GHz	Power @ 1 GHz
1 piece price shown. See web or call for volume pricing.	* dia.	8 dB/100ft	1400 W
12" 24" 36" 48"	60" 72"	48"	Custom Len.
\$214.22 \$229.17 \$244.10 \$259.05	\$273.98 \$288.94	See Web	

Standard Flexible Cable Assemblies

RG8A/U Coax, 50 Ohm

Part No. PE35284	Cable Dia.	Attn. @ 1 GHz	Power @ 1 GHz
1 piece price shown. See web or call for volume pricing.	0.405" dia.	8 dB/100ft	190 W
12" 24" 36" 48"	60" 72"	48"	Custom Len.
\$163.59 \$166.42 \$179.55 \$172.09	\$174.92 \$177.75	See Web	

RG58C/U Coax, 50 Ohm

Part No. PE3207	Cable Dia.	Attn. @ 1 GHz	Power @ 1 GHz
1 piece price shown. See web or call for volume pricing.	0.195" dia.	20 dB/100ft	44 W
12" 24" 36" 48"	60" 72"	48"	Custom Len.
\$143.42 \$144.16 \$144.90 \$145.63	\$146.36 \$147.10	See Web	

RG142B/U Coax, 50 Ohm

Cable Assemblies

See Our Website For Current Pricing & Real-Time Stock Availability!

Continued on Next Page

For Custom Lengths, Metric Lengths or Special Configurations, Please call (949) 261-1920



For our complete selection of cable assemblies, please visit our website

N MALE TO BNC FEMALE BULKHEAD						
SEE MOUNTING HOLE SECTION ON PAGE 369						
Standard Flexible Cable Assemblies						
RG400/U Coax, 50 Ohm						
Part No. PE34882	Cable Dia.			Attn. @ 1 GHz	Power @ 1 GHz	
1 piece price shown. See web or call for volume pricing.						
12"	24"	36"	48"	60"	72"	Custom Len.
\$65.84	\$73.23	\$80.63	\$88.45	\$95.99	-	See Web
Standard Flexible Cable Assemblies						
RG142B/U Coax, 50 Ohm						
Part No. PE3W06365	Cable Dia.			Attn. @ 1 GHz	Power @ 1 GHz	
1 piece price shown. See web or call for volume pricing.						
12"	24"	36"	48"	60"	50CM	Custom Len.
\$113.25	\$119.14	\$125.04	\$130.95	\$136.85	\$117.02	See Web
Standard Flexible Cable Assemblies						
RG58C/U Coax, 50 Ohm						
Part No. PE3282	Cable Dia.			Attn. @ 1 GHz	Power @ 1 GHz	
1 piece price shown. See web or call for volume pricing.						
12"	24"	36"	48"	60"	72"	Custom Len.
\$40.87	\$44.96	\$45.77	\$43.09	\$47.46	\$44.55	See Web
Standard Flexible Cable Assemblies						
RG142B/U Coax, 50 Ohm						
Part No. PE3285	Cable Dia.			Attn. @ 1 GHz	Power @ 1 GHz	
1 piece price shown. See web or call for volume pricing.						
12"	24"	36"	48"	60"	72"	Custom Len.
\$43.06	\$49.13	\$55.21	\$61.64	\$67.84	\$74.04	See Web
Standard Flexible Cable Assemblies						
RG223/U Coax, 50 Ohm						
Part No. PE3280	Cable Dia.			Attn. @ 1 GHz	Power @ 1 GHz	
1 piece price shown. See web or call for volume pricing.						
12"	24"	36"	48"	60"	72"	Custom Len.
\$35.67	\$38.56	\$41.48	\$44.44	\$50.51	\$50.26	See Web
Standard Flexible Cable Assemblies						
RG303/U Coax, 50 Ohm						
Part No. PE3W04230	Cable Dia.			Attn. @ 1 GHz	Power @ 1 GHz	
1 piece price shown. See web or call for volume pricing.						
12"	24"	36"	48"	60"	50CM	Custom Len.
\$35.14	\$42.01	\$48.88	\$55.76	\$62.64	\$39.54	See Web
Standard Flexible Cable Assemblies						
RG400/U Coax, 50 Ohm						
Part No. PE3288	Cable Dia.			Attn. @ 1 GHz	Power @ 1 GHz	
1 piece price shown. See web or call for volume pricing.						
12"	24"	36"	48"	60"	72"	Custom Len.
\$51.42	\$55.48	\$62.45	\$69.42	\$76.39	\$83.36	See Web
Standard Flexible Cable Assemblies						
Flexible Cable Assemblies						
PE-C500 Coax, 50 Ohm						
Part No. PE35522	Cable Dia.			Attn. @ 1 GHz	Power @ 1 GHz	
1 piece price shown. See web or call for volume pricing.						
12"	24"	36"	48"	60"	-	Custom Len.
\$89.81	\$93.82	\$97.85	\$101.87	\$105.88	-	See Web
Corrugated Cable Assemblies						
PE-1/4SFHC Coax, 50 Ohm						
Part No. PE3C0124	Cable Dia.			Attn. @ 1 GHz	Power @ 1 GHz	
1 piece price shown. See web or call for volume pricing.						
12"	24"	36"	48"	60"	-	Custom Len.
\$132.41	\$135.53	\$138.64	\$141.94	\$145.11	-	See Web
Standard Flexible Cable Assemblies						
SPP-250-LLPL Coax, 50 Ohm						
Part No. PE3C4137	Cable Dia.			Attn. @ 1 GHz	Power @ 1 GHz	
1 piece price shown. See web or call for volume pricing.						
12"	24"	36"	48"	60"	50CM	Custom Len.
\$87.70	\$93.28	\$98.86	\$104.44	\$110.02	\$91.28	See Web
Precision Formable Cable Assemblies						
PE-SR402FLJ Coax, 50 Ohm						
Part No. PE39465	Cable Dia.			Attn. @ 1 GHz	Power @ 1 GHz	
1 piece price shown. See web or call for volume pricing.						
6"	9"	12"	18"	24"	-	Custom Len.
\$52.96	\$55.18	\$52.96	\$56.74	\$65.51	-	See Web
Standard Flexible Cable Assemblies						
PE-80TEST Coax, 50 Ohm						
Part No. PE3TC0103	Cable Dia.			Attn. @ 1 GHz	Power @ 1 GHz	
1 piece price shown. See web or call for volume pricing.						
24"	48"	72"	-	-	-	Custom Len.
\$340.60	\$426.34	\$512.09	-	-	-	See Web

PE-90TEST Coax, 50 Ohm						
Part No. PE3TC0302	Cable Dia.			Attn. @ 1 GHz	Power @ 1 GHz	
1 piece price shown. See web or call for volume pricing.						
24"	48"	72"	-	-	-	Custom Len.
\$278.24	\$356.19	\$434.15	-	-	-	See Web
Low Loss Formable Cable Assemblies						
LMR-SW396 Coax, 50 Ohm						
Part No. PE3C0139	Cable Dia.			Attn. @ 1 GHz	Power @ 1 GHz	
1 piece price shown. See web or call for volume pricing.						
12"	24"	36"	48"	60"	-	Custom Len.
\$79.18	\$81.47	\$88.67	\$86.02	\$88.32	-	See Web
Standard Flexible Cable Assemblies						
LMR-SW540 Coax, 50 Ohm						
Part No. PE3C0142	Cable Dia.			Attn. @ 1 GHz	Power @ 1 GHz	
1 piece price shown. See web or call for volume pricing.						
12"	24"	36"	48"	60"	-	Custom Len.
\$84.20	\$86.81	\$94.48	\$92.02	\$94.64	-	See Web
Low Loss Flexible Cable Assemblies						
PE-C195 Coax, 50 Ohm						
Part No. PE37940	Cable Dia.			Attn. @ 1 GHz	Power @ 1 GHz	
1 piece price shown. See web or call for volume pricing.						
36"	48"	60"	72"	120"	-	Custom Len.
\$32.27	\$33.10	\$33.90	\$34.69	\$37.88	-	See Web
Standard Flexible Cable Assemblies						
PE-C200 Coax, 50 Ohm						
Part No. PE34693	Cable Dia.			Attn. @ 1 GHz	Power @ 1 GHz	
1 piece price shown. See web or call for volume pricing.						
12"	24"	36"	48"	60"	-	Custom Len.
\$45.65	\$47.25	\$51.45	\$55.65	\$59.86	-	See Web
Standard Flexible Cable Assemblies						
PE-C240 Coax, 50 Ohm						
Part No. PE37941	Cable Dia.			Attn. @ 1 GHz	Power @ 1 GHz	
1 piece price shown. See web or call for volume pricing.						
36"	48"	60"	72"	120"	-	Custom Len.
\$49.59	\$50.80	\$48.78	\$53.10	\$62.14	-	See Web
Standard Flexible Cable Assemblies						
PE-C300 Coax, 50 Ohm						
Part No. PE36634	Cable Dia.			Attn. @ 1 GHz	Power @ 1 GHz	
1 piece price shown. See web or call for volume pricing.						
12"	24"	36"	48"	60"	-	Custom Len.
\$68.47	\$67.43	\$75.02	\$73.09	\$75.93	-	See Web
Standard Flexible Cable Assemblies						
PE-C400 Coax, 50 Ohm						
Part No. PE34666	Cable Dia.			Attn. @ 1 GHz	Power @ 1 GHz	
1 piece price shown. See web or call for volume pricing.						
12"	24"	36"	48"	60"	-	Custom Len.
\$58.64	\$62.48	\$63.96	\$65.54	\$68.92	-	See Web
Standard Flexible Cable Assemblies						
PE-C400 Coax, 50 Ohm						
Part No. PE37942	Cable Dia.			Attn. @ 1 GHz	Power @ 1 GHz	
1 piece price shown. See web or call for volume pricing.						
36"	48"	60"	72"	120"	-	Custom Len.
\$65.77	\$67.35	\$64.51	\$65.83	-	-	See Web
Standard Flexible Cable Assemblies						
PE-C600 Coax, 50 Ohm						
Part No. PE37943	Cable Dia.			Attn. @ 1 GHz	Power @ 1 GHz	
1 piece price shown. See web or call for volume pricing.						
36"	48"	60"	72"	120"	-	Custom Len.
\$104.56	\$107.04	\$109.51	\$111.99	\$129.65	-	See Web
Standard Flexible Cable Assemblies						
LMR-240 Coax, 50 Ohm						
Part No. PE3C0039	Cable Dia.			Attn. @ 1 GHz	Power @ 1 GHz	
1 piece price shown. See web or call for volume pricing.						
12"	24"	36"	48"	60"	-	Custom Len.
\$41.27	\$42.24	\$43.21	\$44.24	\$45.24	-	See Web
Standard Flexible Cable Assemblies						
PE-C500 Coax, 50 Ohm						
Part No. PE3C0053	Cable Dia.			Attn. @ 1 GHz	Power @ 1 GHz	
1 piece price shown. See web or call for volume pricing.						
12"	24"	36"	48"	60"	-	Custom Len.
\$54.43	\$55.28	\$56.13	\$56.98	\$57.83	-	See Web
Standard Flexible Cable Assemblies						
PE-C500 Coax, 50 Ohm						
Part No. PE3C0101	Cable Dia.			Attn. @ 1 GHz	Power @ 1 GHz	
1 piece price shown. See web or call for volume pricing.						
12"	24"	36"	48"	60"	-	Custom Len.
\$45.71	\$46.68	\$47.66	\$48.69	\$49.67	-	See Web
Standard Flexible Cable Assemblies						
LMR-400 Coax, 50 Ohm						
Part No. PE3C0033	Cable Dia.			Attn. @ 1 GHz	Power @ 1 GHz	
1 piece price shown. See web or call for volume pricing.						
12"	24"	36"	48"	60"	-	Custom Len.
\$48.43	\$49.81	\$51.19	\$52.66	\$54.06	-	See Web
Standard Flexible Cable Assemblies						
PE-C500 Coax, 50 Ohm						
Part No. PE3C0046	Cable Dia.			Attn. @ 1 GHz	Power @ 1 GHz	
1 piece price shown. See web or call for volume pricing.						
12"	24"	36"	48"	60"	-	Custom Len.
\$49.66	\$51.05	\$52.43	\$53.88	\$55.30	-	See Web
Standard Flexible Cable Assemblies						
PE-C500 Coax, 50 Ohm						
Part No. PE3C0105	Cable Dia.			Attn. @ 1 GHz	Power @ 1 GHz	
1 piece price shown. See web or call for volume pricing.						
12"	24"	36"	48"	60"	-	Custom Len.
\$80.66	\$82.03	\$83.41	\$84.88	\$86.28	-	See Web
Standard Flexible Cable Assemblies						
LMR-400-UF Coax, 50 Ohm						
Part No. PE3W08067	Cable Dia.			Attn. @ 1 GHz	Power @ 1 GHz	
1 piece price shown. See web or call for volume pricing.						
12"	18"	24"	36"	48"	60"	Custom Len.
\$48.30	\$49.56	\$50.83	\$53.36	\$55.89	\$58.42	See Web
Standard Flexible Cable Assemblies						
LMR-600 Coax, 50 Ohm						

Cable Assemblies

See Our Website For Current Pricing & Real-Time Stock Availability!

Continued on Next Page

For Custom Lengths, Metric Lengths or Special Configurations, Please call (949) 261-1920

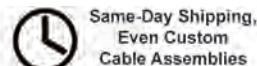
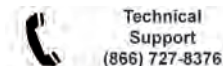

For our complete selection of cable assemblies, please visit our website

Part No. PE3C0048	Cable Dia.	Attn. @ 1 GHz	Power @ 1 GHz
1 piece price shown. See web or call for volume pricing.	0.590" dia.	3 dB/100ft	W
12" 24" 36" 48"	60"	-	Custom Len.
\$142.62 \$145.46 \$140.21 \$151.30	\$145.88	-	See Web
Part No. PE3C0062	Cable Dia.	Attn. @ 1 GHz	Power @ 1 GHz
1 piece price shown. See web or call for volume pricing.	0.590" dia.	3 dB/100ft	W
12" 24" 36" 48"	60"	-	Custom Len.
\$131.07 \$141.77 \$144.61 \$147.61	\$150.50	-	See Web
Part No. PE3C0110	Cable Dia.	Attn. @ 1 GHz	Power @ 1 GHz
1 piece price shown. See web or call for volume pricing.	0.590" dia.	3 dB/100ft	W
12" 24" 36" 48"	60"	-	Custom Len.
\$106.89 \$116.14 \$112.57 \$115.39	\$124.87	-	See Web
Part No. PE3C0112	Cable Dia.	Attn. @ 1 GHz	Power @ 1 GHz
1 piece price shown. See web or call for volume pricing.	0.590" dia.	3 dB/100ft	W
12" 24" 36" 48"	60"	-	Custom Len.
\$78.25 \$76.66 \$79.49 \$82.32	\$85.16	-	See Web
LMR-195 Coax, 50 Ohm			
Part No. PE3C0060	Cable Dia.	Attn. @ 1 GHz	Power @ 1 GHz
1 piece price shown. See web or call for volume pricing.	0.195" dia.	12 dB/100ft	W
12" 24" 36" 48"	60"	-	Custom Len.
\$41.34 \$44.57 \$42.84 \$43.59	\$46.88	-	See Web
Part No. PE3C0061	Cable Dia.	Attn. @ 1 GHz	Power @ 1 GHz
1 piece price shown. See web or call for volume pricing.	0.195" dia.	12 dB/100ft	W
12" 24" 36" 48"	60"	-	Custom Len.
\$40.17 \$43.33 \$44.07 \$42.41	\$45.63	-	See Web
Part No. PE3C0118	Cable Dia.	Attn. @ 1 GHz	Power @ 1 GHz
1 piece price shown. See web or call for volume pricing.	0.195" dia.	12 dB/100ft	W
12" 24" 36" 48"	60"	-	Custom Len.
\$47.37 \$48.12 \$46.18 \$49.66	\$50.42	-	See Web
PE-P142LL Coax, 50 Ohm			
Part No. PE3C0231	Cable Dia.	Attn. @ 1 GHz	Power @ 1 GHz
1 piece price shown. See web or call for volume pricing.	0.320" dia.	7 dB/100ft	W
24" 36" 48" 60" 120"	72" 120"	Custom Len.	See Web
\$332.34 \$409.35 \$420.82 \$453.08	\$472.35 \$718.69	See Web	See Web
Part No. PE343	Cable Dia.	Attn. @ 1 GHz	Power @ 1 GHz
1 piece price shown. See web or call for volume pricing.	0.195" dia.	7 dB/100ft	W
12" 24" 36" 48"	60" 50CM	Custom Len.	See Web
\$120.21 \$136.44 \$152.68 \$168.92	\$185.15 \$130.61	See Web	See Web
PE-SF200LL Coax, 50 Ohm			
Part No. PE3TC1102	Cable Dia.	Attn. @ 1 GHz	Power @ 1 GHz
1 piece price shown. See web or call for volume pricing.	0.185" dia.	dB/100ft	W
24" 36" 48" 100CM	200CM	-	Custom Len.
\$77.60 \$88.86 \$100.12 \$92.01	\$128.96	-	See Web
PE-P142LL-27478 Coax, 50 Ohm			
Part No. PE3M0174	Cable Dia.	Attn. @ 1 GHz	Power @ 1 GHz
1 piece price shown. See web or call for volume pricing.	0.195" dia.	dB/100ft	W
12" 18" 24" 36"	48"	60"	Custom Len.
\$370.05 \$378.53 \$387.01 \$403.96	\$420.92 \$437.88	See Web	See Web
PE-P160LL-27478 Coax, 50 Ohm			
Part No. PE3M0219	Cable Dia.	Attn. @ 1 GHz	Power @ 1 GHz
1 piece price shown. See web or call for volume pricing.	0.160" dia.	dB/100ft	W
8" 12" 18" 24"	30" 36"	Custom Len.	See Web
\$340.63 \$345.53 \$352.89 \$360.23	\$367.59 \$374.93	See Web	See Web
PE-P300LL-27478 Coax, 50 Ohm			
Part No. PE3M0247	Cable Dia.	Attn. @ 1 GHz	Power @ 1 GHz
1 piece price shown. See web or call for volume pricing.	0.300" dia.	dB/100ft	W
12" 18" 24" 36"	48" 60"	Custom Len.	See Web
\$418.06 \$432.21 \$446.36 \$474.67	\$502.97 \$531.27	See Web	See Web
PE-P160LL Coax, 50 Ohm			
Part No. PE3C5255	Cable Dia.	Attn. @ 1 GHz	Power @ 1 GHz
1 piece price shown. See web or call for volume pricing.	0.160" dia.	dB/100ft	W
12" 24" 36" 48"	60" 50CM	Custom Len.	See Web
\$205.44 \$226.16 \$246.87 \$267.58	\$288.29 \$218.71	See Web	See Web
Low PIM Formable Cable Assemblies			
PE-SR401FLJ Low PIM Coax, 50 Ohm			
Part No. PE3C2011	Cable Dia.	Attn. @ 1 GHz	Power @ 1 GHz
1 piece price shown. See web or call for volume pricing.	0.276" dia.	dB/100ft	W
100CM 200CM	-	-	Custom Len.
\$109.93 \$141.71	-	-	See Web
PE-SR402FLJ Low PIM Coax, 50 Ohm			
Part No. PE3C2000	Cable Dia.	Attn. @ 1 GHz	Power @ 1 GHz
1 piece price shown. See web or call for volume pricing.	0.161" dia.	dB/100ft	W
100CM 200CM	-	-	Custom Len.
\$79.93 \$91.81	-	-	See Web
Low Loss Test Flexible Cable Assemblies			
PE-P300LL Coax, 50 Ohm			
Part No. PE330	Cable Dia.	Attn. @ 1 GHz	Power @ 1 GHz
1 piece price shown. See web or call for volume pricing.	0.300" dia.	5 dB/100ft	W
12" 24" 36" 48"	60" 50CM	Custom Len.	See Web
\$270.12 \$296.06 \$322.01 \$347.93	\$373.87 \$286.74	See Web	See Web
Standard Formable Cable Assemblies			
PE-SR401FL Coax, 50 Ohm			

Part No. PE34149	Cable Dia.	Attn. @ 1 GHz	Power @ 1 GHz
1 piece price shown. See web or call for volume pricing.	" dia.	8 dB/100ft	1400 W
6" 12" 18" 24"	36" 48"	Custom Len.	See Web
\$132.92 \$140.90 \$140.63 \$157.22	\$173.55 \$190.83	See Web	See Web
PE-SR402FL Coax, 50 Ohm			
Part No. PE39451	Cable Dia.	Attn. @ 1 GHz	Power @ 1 GHz
1 piece price shown. See web or call for volume pricing.	" dia.	12 dB/100ft	400 W
6" 9" 12" 18"	24"	Custom Len.	See Web
\$62.61 \$53.17 \$53.17 \$56.94	\$60.71	-	See Web
Part No. PE3472	Cable Dia.	Attn. @ 1 GHz	Power @ 1 GHz
1 piece price shown. See web or call for volume pricing.	" dia.	12 dB/100ft	450 W
6" 12" 18" 24"	36" 48"	Custom Len.	See Web
\$83.37 \$87.30 \$91.33 \$95.37	\$97.43 \$104.97	See Web	See Web
PE-SR405FL Coax, 50 Ohm			
Part No. PE3963	Cable Dia.	Attn. @ 1 GHz	Power @ 1 GHz
1 piece price shown. See web or call for volume pricing.	" dia.	23 dB/100ft	130 W
6" 12" 18" 24"	36" 48"	Custom Len.	See Web
\$111.80 \$111.80 \$117.15 \$122.50	\$133.19 \$143.88	See Web	See Web
Standard Flexible Cable Assemblies			
RG8A/U Coax, 50 Ohm			
Part No. PE3570	Cable Dia.	Attn. @ 1 GHz	Power @ 1 GHz
1 piece price shown. See web or call for volume pricing.	0.405" dia.	8 dB/100ft	190 W
12" 24" 36" 48"	60" 72"	Custom Len.	See Web
\$61.73 \$68.50 \$71.58 \$74.83	\$77.96 \$81.08	See Web	See Web
RG8X Coax, 50 Ohm			
Part No. PE33720	Cable Dia.	Attn. @ 1 GHz	Power @ 1 GHz
1 piece price shown. See web or call for volume pricing.	0.242" dia.	14 dB/100ft	60 W
12" 24" 36" 48"	60"	Custom Len.	See Web
\$73.01 \$71.93 \$74.97 \$83.81	\$81.09	-	See Web
RG58C/U Coax, 50 Ohm			
Part No. PE3441	Cable Dia.	Attn. @ 1 GHz	Power @ 1 GHz
1 piece price shown. See web or call for volume pricing.	0.195" dia.	20 dB/100ft	44 W
12" 24" 36" 48"	60" 72"	Custom Len.	See Web
\$47.51 \$48.32 \$49.13 \$50.00	\$50.83 \$51.66	See Web	See Web
RG141A/U Coax, 50 Ohm			
Part No. PE36589	Cable Dia.	Attn. @ 1 GHz	Power @ 1 GHz
1 piece price shown. See web or call for volume pricing.	0.190" dia.	13 dB/100ft	650 W
12" 24" 36" 48"	60"	Custom Len.	See Web
\$60.92 \$71.47 \$78.37 \$85.69	\$92.72	-	See Web
RG142B/U Coax, 50 Ohm			
Part No. PE3455	Cable Dia.	Attn. @ 1 GHz	Power @ 1 GHz
1 piece price shown. See web or call for volume pricing.	0.195" dia.	13 dB/100ft	650 W
6" 12" 18" 24"	30" 36"	Custom Len.	See Web
\$47.30 \$50.25 \$53.28 \$56.32	\$57.37 \$62.40	See Web	See Web
RG174A/U Coax, 50 Ohm			
Part No. PE36273	Cable Dia.	Attn. @ 1 GHz	Power @ 1 GHz
1 piece price shown. See web or call for volume pricing.	0.100" dia.	32 dB/100ft	16 W
12" 24" 36" 48"	60"	Custom Len.	See Web
\$50.85 \$55.49 \$51.72 \$56.69	\$57.27	-	See Web
RG178B/U Coax, 50 Ohm			
Part No. PE33527	Cable Dia.	Attn. @ 1 GHz	Power @ 1 GHz
1 piece price shown. See web or call for volume pricing.	0.072" dia.	44 dB/100ft	78 W
12" 24" 36" 48"	60" 72"	Custom Len.	See Web
\$76.56 \$77.62 \$74.15 \$75.10	\$76.07 \$77.01	See Web	See Web
RG188A/U Coax, 50 Ohm			
Part No. PE33525	Cable Dia.	Attn. @ 1 GHz	Power @ 1 GHz
1 piece price shown. See web or call for volume pricing.	0.110" dia.	26 dB/100ft	160 W
12" 24" 36" 48"	60" 72"	Custom Len.	See Web
\$56.54 \$58.76 \$60.98 \$63.20	\$65.42 \$67.64	See Web	See Web
RG213/U Coax, 50 Ohm			
Part No. PE3496	Cable Dia.	Attn. @ 1 GHz	Power @ 1 GHz
1 piece price shown. See web or call for volume pricing.	0.405" dia.	8 dB/100ft	190 W
12" 24" 36" 48"	60" 72"	Custom Len.	See Web
\$63.09 \$64.88 \$66.66 \$68.55	\$70.37 \$72.19	See Web	See Web
RG214/U Coax, 50 Ohm			
Part No. PE3062	Cable Dia.	Attn. @ 1 GHz	Power @ 1 GHz
1 piece price shown. See web or call for volume pricing.	0.425" dia.	7 dB/100ft	170 W
12" 24" 36" 48"	60" 72"	Custom Len.	See Web
\$65.77 \$73.55 \$81.33 \$89.56	\$97.50 \$105.43	See Web	See Web
RG217/U Coax, 50 Ohm			
Part No. PE3997	Cable Dia.	Attn. @ 1 GHz	Power @ 1 GHz
1 piece price shown. See web or call for volume pricing.	0.545" dia.	6 dB/100ft	260 W
12" 24" 36" 48"	60" 72"	Custom Len.	See Web
\$98.99 \$103.71 \$108.43 \$113.42	\$118.23 \$115.50	See Web	See Web
RG218/U Coax, 50 Ohm			
Part No. PE33236	Cable Dia.	Attn. @ 1 GHz	Power @ 1 GHz
1 piece price shown. See web or call for volume pricing.	0.870" dia.	4 dB/100ft	560 W
12" 24" 36" 48"	60" 72"	Custom Len.	See Web
\$232.35 \$258.48 \$255.34 \$283.57	\$278.34 \$308.43	See Web	See Web
RG223/U Coax, 50 Ohm			
Part No. PE3W00417	Cable Dia.	Attn. @ 1 GHz	Power @ 1 GHz
1 piece price shown. See web or call for volume pricing.	0.209" dia.	13 dB/100ft	50 W
12" 24" 36" 48"	60" 50CM	Custom Len.	See Web
\$47.35 \$60.45 \$63.69 \$66.93	\$70.17 \$59.27	See Web	See Web

Cable Assemblies See Our Website For Current Pricing & Real-Time Stock Availability!

*Coax Performance at 1 GHz Notes: Cable assembly max frequency may be lower than connector or coax max frequency

For our complete selection of cable assemblies, please visit our website

Part No.	Cable Dia.				Attn. @ 1 GHz	Power @ 1 GHz
Part No. PE3447	0.210" dia.				13 dB/100ft	53 W
1 piece price shown. See web or call for volume pricing.						
6"	12"	18"	24"	30"	36"	Custom Len.
\$46.03	\$47.87	\$49.43	\$50.98	\$50.38	\$54.10	See Web
RG225/U Coax, 50 Ohm						
Part No. PE33269	0.430" dia.				dB/100ft	1700 W
1 piece price shown. See web or call for volume pricing.						
12"	24"	36"	48"	60"	72"	Custom Len.
\$87.70	\$121.29	\$164.21	\$188.50	\$222.10	-	See Web
RG316/U Coax, 50 Ohm						
Part No. PE3487	0.098" dia.				38 dB/100ft	160 W
1 piece price shown. See web or call for volume pricing.						
12"	24"	36"	48"	60"	72"	Custom Len.
\$62.06	\$65.19	\$63.24	\$66.13	\$74.81	\$71.91	See Web
RG316-DS Coax, 50 Ohm						
Part No. PE33288	0.114" dia.				26 dB/100ft	160 W
1 piece price shown. See web or call for volume pricing.						
12"	24"	36"	48"	60"	72"	Custom Len.
\$53.24	\$56.14	\$59.06	\$61.97	\$64.88	-	See Web
RG393/U Coax, 50 Ohm						
Part No. PE3607	0.390" dia.				9 dB/100ft	1700 W
1 piece price shown. See web or call for volume pricing.						
12"	24"	36"	48"	60"	72"	Custom Len.
\$79.81	\$96.21	\$112.62	\$129.98	\$146.71	\$163.43	See Web
RG400/U Coax, 50 Ohm						
Part No. PE3653	0.195" dia.				15 dB/100ft	650 W
1 piece price shown. See web or call for volume pricing.						
12"	24"	36"	48"	60"	72"	Custom Len.
\$59.97	\$67.37	\$74.76	\$82.59	\$90.12	\$97.67	See Web
PE-B400 Coax, 50 Ohm						
Part No. PE3629	0.403" dia.				6 dB/100ft	190 W
1 piece price shown. See web or call for volume pricing.						
12"	24"	36"	48"	60"	72"	Custom Len.
\$53.33	\$55.03	\$56.70	\$58.39	\$60.07	-	See Web
PE-P141 Coax, 50 Ohm						
Part No. PE302	0.163" dia.				dB/100ft	W
1 piece price shown. See web or call for volume pricing.						
12"	24"	36"	48"	60"	72"	Custom Len.
\$170.06	\$181.41	\$192.77	\$204.79	\$216.36	\$227.94	See Web
Part No. PE352	0.163" dia.				11 dB/100ft	600 W
1 piece price shown. See web or call for volume pricing.						
12"	24"	36"	48"	60"	72"	Custom Len.
\$123.94	\$135.30	\$146.64	\$158.67	\$170.24	\$171.13	See Web
PE-P141EAM Coax, 50 Ohm						
Part No. PE3CA1047	0.163" dia.				dB/100ft	W
1 piece price shown. See web or call for volume pricing.						
12"	24"	36"	50CM	100CM	-	Custom Len.
\$89.80	\$107.29	\$124.77	\$101.00	\$129.66	-	See Web
PE-P195 Coax, 50 Ohm						
Part No. PE33377	0.195" dia.				13 dB/100ft	650 W
1 piece price shown. See web or call for volume pricing.						
12"	24"	36"	48"	60"	72"	Custom Len.
\$55.02	\$64.58	\$74.16	\$84.30	\$94.07	-	See Web
LMR-400-UF Coax, 50 Ohm						
Part No. PE3C0218	0.405" dia.				5 dB/100ft	W
1 piece price shown. See web or call for volume pricing.						
12"	24"	36"	48"	60"	50CM	Custom Len.
\$49.23	\$51.78	\$54.34	\$56.90	\$59.45	\$50.87	See Web
PE-FF430 Coax, 50 Ohm						
Part No. PE3C4002	0.430" dia.				dB/100ft	W
1 piece price shown. See web or call for volume pricing.						
60"	144"	-	-	-	-	Custom Len.
\$494.77	\$729.86	-	-	-	-	See Web
Part No. PE3C4005	0.430" dia.				dB/100ft	W
1 piece price shown. See web or call for volume pricing.						
100CM	-	-	-	-	-	Custom Len.
\$637.06	-	-	-	-	-	See Web
PE-VNA-R Coax, 50 Ohm						
Part No. PE3VNA1803	0.430" dia.				dB/100ft	W
1 piece price shown. See web or call for volume pricing.						
24"	36"	48"	60"	-	-	Custom Len.
\$791.80	\$918.70	\$880.58	\$1,016.11	-	-	See Web
Standard Semi-Rigid Cable Assemblies						
PE-047SR Coax, 50 Ohm						
Part No. PE34142	0.047" dia.				40 dB/100ft	32 W
1 piece price shown. See web or call for volume pricing.						
6"	12"	18"	24"	36"	48"	Custom Len.
\$91.23	\$102.01	\$101.21	\$113.07	\$116.10	\$125.99	See Web
PE-SR402AL Coax, 50 Ohm						
Part No. PE34138	" dia.				13 dB/100ft	450 W
1 piece price shown. See web or call for volume pricing.						
6"	12"	18"	24"	36"	48"	Custom Len.
\$79.32	\$84.25	\$89.34	\$88.61	\$97.73	\$106.85	See Web

Part No.	Cable Dia.				Attn. @ 1 GHz	Power @ 1 GHz
Part No. PE34140	" dia.				23 dB/100ft	130 W
1 piece price shown. See web or call for volume pricing.						
6"	12"	18"	24"	36"	48"	Custom Len.
\$99.30	\$103.48	\$107.68	\$111.83	\$120.23	\$128.57	See Web
RG401/U Coax, 50 Ohm						
Part No. PE3782	" dia.				8 dB/100ft	870 W
1 piece price shown. See web or call for volume pricing.						
6"	12"	18"	24"	36"	48"	Custom Len.
\$139.59	\$139.59	\$150.57	\$161.53	\$183.48	\$217.29	See Web
RG402/U Coax, 50 Ohm						
Part No. PE3827	" dia.				12 dB/100ft	650 W
1 piece price shown. See web or call for volume pricing.						
6"	12"	24"	36"	48"	60"	Custom Len.
\$82.09	\$82.09	\$90.93	\$94.84	\$96.70	\$104.00	See Web
RG405/U Coax, 50 Ohm						
Part No. PE3920	" dia.				22 dB/100ft	130 W
1 piece price shown. See web or call for volume pricing.						
6"	12"	18"	24"	36"	48"	Custom Len.
\$98.45	\$101.74	\$105.11	\$108.41	\$122.70	\$121.74	See Web
PE-SR401AL-STRAIGHT Coax, 50 Ohm						
Part No. PE3995	0.250" dia.				8 dB/100ft	1400 W
1 piece price shown. See web or call for volume pricing.						
6"	12"	18"	24"	36"	48"	Custom Len.
\$135.72	\$143.87	\$144.80	\$153.87	\$172.02	\$190.16	See Web
Standard Flexible Cable Assemblies						
RG55B/U Coax, 53 Ohm						
Part No. PE3499	0.202" dia.				17 dB/100ft	53 W
1 piece price shown. See web or call for volume pricing.						
12"	24"	36"	48"	60"	72"	Custom Len.
\$47.01	\$49.26	\$51.49	\$53.74	\$55.98	\$58.22	See Web
RG11A/U Coax, 75 Ohm						
Part No. PE33479	0.405" dia.				dB/100ft	150 W
1 piece price shown. See web or call for volume pricing.						
12"	24"	36"	48"	60"	-	Custom Len.
\$65.51	\$67.58	\$65.24	\$66.94	\$68.67	-	See Web
N MALE TO N MALE RIGHT ANGLE						
Flexible Cable Assemblies						
PE-P142LL Coax, 50 Ohm						
Part No. PE345	0.195" dia.				7 dB/100ft	820 W
1 piece price shown. See web or call for volume pricing.						
12"	24"	36"	48"	60"	50CM	Custom Len.
\$222.67	\$238.90	\$255.14	\$271.38	\$287.61	\$233.08	See Web
Precision Formable Cable Assemblies						
PE-SR402FL Coax, 50 Ohm						
Part No. PE39453	" dia.				12 dB/100ft	450 W
1 piece price shown. See web or call for volume pricing.						
6"	9"	12"	18"	24"	-	Custom Len.
\$58.55	\$60.51	\$57.84	\$83.39	\$88.71	-	See Web
Low Loss Formable Cable Assemblies						
LMR-SW396 Coax, 50 Ohm						
Part No. PE3C0144	0.450" dia.				3 dB/100ft	W
1 piece price shown. See web or call for volume pricing.						
12"	24"	36"	48"	60"	-	Custom Len.
\$86.49	\$88.84	\$91.20	\$93.58	\$95.94	-	See Web
Low Loss Flexible Cable Assemblies						
PE-C100-LSZH Coax, 50 Ohm						
Part No. PE38934	0.109" dia.				25 dB/100ft	W
1 piece price shown. See web or call for volume pricing.						
12"	24"	36"	48"	60"	-	Custom Len.
\$54.17	\$55.37	\$56.57	\$57.78	\$58.98	-	See Web
PE-C195 Coax, 50 Ohm						
Part No. PE37944	0.195" dia.				11 dB/100ft	150 W
1 piece price shown. See web or call for volume pricing.						
36"	48"	60"	72"	120"	-	Custom Len.
\$50.65	\$51.37	\$52.06	\$52.78	\$55.64	-	See Web
PE-C240 Coax, 50 Ohm						
Part No. PE37945	0.240" dia.				9 dB/100ft	250 W
1 piece price shown. See web or call for volume pricing.						
36"	48"	60"	72"	120"	-	Custom Len.
\$61.06	\$62.03	\$63.00	\$65.61	\$76.27	-	See Web
PE-C400 Coax, 50 Ohm						
Part No. PE37946	0.400" dia.				4 dB/100ft	550 W
1 piece price shown. See web or call for volume pricing.						
36"	48"	60"	72"	120"	-	Custom Len.
\$86.78	\$88.35	\$89.86	\$92.95	\$97.45	-	See Web
PE-C600 Coax, 50 Ohm						

Cable Assemblies

See Our Website For Current Pricing & Real-Time Stock Availability!

Continued on Next Page

For Custom Lengths, Metric Lengths or Special Configurations, Please call (949) 261-1920

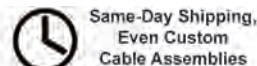
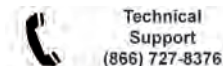

For our complete selection of cable assemblies, please visit our website

Part No.	Cable Dia.	Attn. @ 1 GHz	Power @ 1 GHz
Part No. PE37947	0.590" dia.	3 dB/100ft	900 W
1 piece price shown. See web or call for volume pricing.			
36"	48"	60"	72"
\$124.30	\$126.76	\$137.18	\$131.71
		\$141.62	-
		-	Custom Len.
		-	See Web
LMR-400 Coax, 50 Ohm			
Part No. PE3C0041	0.405" dia.	4 dB/100ft	W
1 piece price shown. See web or call for volume pricing.			
12"	24"	36"	48"
\$78.06	\$75.03	\$76.39	\$82.29
			\$83.69
			Custom Len.
			See Web
Part No. PE3C0106	0.405" dia.	4 dB/100ft	W
1 piece price shown. See web or call for volume pricing.			
12"	24"	36"	48"
\$78.17	\$81.90	\$80.92	\$82.29
			\$86.15
			Custom Len.
			See Web
Part No. PE3W00430	0.405" dia.	4 dB/100ft	W
1 piece price shown. See web or call for volume pricing.			
12"	24"	36"	48"
\$75.45	\$76.70	\$77.95	\$79.19
			\$80.44
			50CM Custom Len.
			See Web
LMR-400-DB Coax, 50 Ohm			
Part No. PE3W01127	0.405" dia.	4 dB/100ft	W
1 piece price shown. See web or call for volume pricing.			
12"	24"	36"	48"
\$71.30	\$72.74	\$74.18	\$75.63
			\$77.07
			50CM Custom Len.
			See Web
LMR-600 Coax, 50 Ohm			
Part No. PE3C0050	0.590" dia.	3 dB/100ft	W
1 piece price shown. See web or call for volume pricing.			
12"	24"	36"	48"
\$106.51	\$115.73	\$112.18	\$115.01
			\$117.84
			Custom Len.
			See Web
Part No. PE3C0111	0.590" dia.	3 dB/100ft	W
1 piece price shown. See web or call for volume pricing.			
12"	24"	36"	48"
\$100.54	\$103.38	\$112.25	\$109.03
			\$118.14
			Custom Len.
			See Web
PE-P142LL-27478 Coax, 50 Ohm			
Part No. PE3M0176	0.195" dia.	dB/100ft	W
1 piece price shown. See web or call for volume pricing.			
12"	18"	24"	36"
\$485.09	\$493.57	\$502.04	\$519.00
			\$535.96
			60" Custom Len.
			See Web
PE-P160LL-27478 Coax, 50 Ohm			
Part No. PE3M0221	0.160" dia.	dB/100ft	W
1 piece price shown. See web or call for volume pricing.			
8"	12"	18"	24"
\$438.69	\$443.59	\$450.94	\$458.29
			\$465.64
			36" Custom Len.
			See Web
PE-P300LL-27478 Coax, 50 Ohm			
Part No. PE3M0249	0.300" dia.	dB/100ft	W
1 piece price shown. See web or call for volume pricing.			
12"	18"	24"	36"
\$563.00	\$577.15	\$591.31	\$619.61
			\$647.91
			48" Custom Len.
			See Web
PE-P160LL Coax, 50 Ohm			
Part No. PE3C5285	0.160" dia.	dB/100ft	W
1 piece price shown. See web or call for volume pricing.			
12"	24"	36"	48"
\$264.21	\$284.92	\$305.63	\$326.35
			\$347.06
			50CM Custom Len.
			See Web
Low Loss Test Flexible Cable Assemblies			
PE-P300LL Coax, 50 Ohm			
Part No. PE3C3240	0.300" dia.	6 dB/100ft	W
1 piece price shown. See web or call for volume pricing.			
12"	24"	36"	48"
\$250.85	\$276.78	\$302.71	\$328.65
			\$354.59
			50CM Custom Len.
			See Web
Standard Flexible Cable Assemblies			
RG8A/U Coax, 50 Ohm			
Part No. PE3699	0.405" dia.	8 dB/100ft	190 W
1 piece price shown. See web or call for volume pricing.			
12"	24"	36"	48"
\$81.97	\$88.32	\$91.39	\$94.64
			\$93.30
			72" Custom Len.
			See Web
RG58C/U Coax, 50 Ohm			
Part No. PE3143	0.195" dia.	20 dB/100ft	44 W
1 piece price shown. See web or call for volume pricing.			
12"	24"	36"	48"
\$66.55	\$67.37	\$63.09	\$63.83
			\$64.55
			72" Custom Len.
			See Web
RG142B/U Coax, 50 Ohm			
Part No. PE3726	0.195" dia.	13 dB/100ft	650 W
1 piece price shown. See web or call for volume pricing.			
12"	24"	36"	48"
\$63.13	\$71.73	\$77.81	\$84.24
			\$90.44
			60" Custom Len.
			See Web
Part No. PE3W06863	0.195" dia.	dB/100ft	W
1 piece price shown. See web or call for volume pricing.			
12"	24"	36"	48"
\$58.18	\$64.08	\$69.98	\$75.88
			\$81.78
			50CM Custom Len.
			See Web
RG174A/U Coax, 50 Ohm			
Part No. PE34205	0.100" dia.	32 dB/100ft	16 W
1 piece price shown. See web or call for volume pricing.			
12"	24"	36"	48"
\$64.29	\$64.73	\$65.16	\$65.59
			\$66.03
			60" Custom Len.
			See Web
RG213/U Coax, 50 Ohm			

Part No.	Cable Dia.	Attn. @ 1 GHz	Power @ 1 GHz
Part No. PE3797	0.405" dia.	8 dB/100ft	190 W
1 piece price shown. See web or call for volume pricing.			
12"	24"	36"	48"
\$82.35	\$89.08	\$90.87	\$92.76
			\$89.00
			72" Custom Len.
			See Web
RG214/U Coax, 50 Ohm			
Part No. PE3071	0.425" dia.	7 dB/100ft	170 W
1 piece price shown. See web or call for volume pricing.			
12"	24"	36"	48"
\$98.01	\$105.79	\$113.56	\$116.21
			\$129.73
			72" Custom Len.
			See Web
RG223/U Coax, 50 Ohm			
Part No. PE3168	0.209" dia.	13 dB/100ft	50 W
1 piece price shown. See web or call for volume pricing.			
12"	24"	36"	48"
\$67.74	\$65.61	\$73.97	\$77.27
			\$74.32
			72" Custom Len.
			See Web
RG316/U Coax, 50 Ohm			
Part No. PE34210	0.098" dia.	60"	160 W
1 piece price shown. See web or call for volume pricing.			
12"	24"	36"	48"
\$67.02	\$69.91	\$77.29	\$75.68
			\$78.57
			60" Custom Len.
			See Web
RG316-DS Coax, 50 Ohm			
Part No. PE34207	0.114" dia.	26 dB/100ft	160 W
1 piece price shown. See web or call for volume pricing.			
12"	24"	36"	48"
\$63.15	\$66.10	\$68.99	\$71.93
			\$74.87
			60" Custom Len.
			See Web
RG393/U Coax, 50 Ohm			
Part No. PE3255	0.390" dia.	8 dB/100ft	1700 W
1 piece price shown. See web or call for volume pricing.			
12"	24"	36"	48"
\$96.98	\$119.20	\$135.61	\$152.97
			\$169.70
			\$186.42
			Custom Len.
			See Web
RG400/U Coax, 50 Ohm			
Part No. PE33321	0.195" dia.	15 dB/100ft	650 W
1 piece price shown. See web or call for volume pricing.			
12"	24"	36"	48"
\$72.29	\$84.02	\$91.42	\$99.25
			\$100.17
			\$114.32
			60" Custom Len.
			See Web
PE-P141EAM Coax, 50 Ohm			
Part No. PE3CA1048	0.163" dia.	dB/100ft	W
1 piece price shown. See web or call for volume pricing.			
12"	24"	36"	50CM
\$83.82	\$100.13	\$116.45	\$94.26
			\$121.03
			100CM Custom Len.
			See Web
LMR-400-UF Coax, 50 Ohm			
Part No. PE3C3643	0.405" dia.	5 dB/100ft	W
1 piece price shown. See web or call for volume pricing.			
12"	24"	36"	48"
\$53.08	\$55.64	\$58.19	\$60.75
			\$63.31
			\$54.72
			50CM Custom Len.
			See Web
PE-FF430 Coax, 50 Ohm			
Part No. PE3C4003	0.430" dia.	dB/100ft	W
1 piece price shown. See web or call for volume pricing.			
60"	144"	-	-
\$760.79	\$1,047.86	-	-
			-
			Custom Len.
			See Web
Part No. PE3C4006	0.430" dia.	dB/100ft	W
1 piece price shown. See web or call for volume pricing.			
100CM	-	-	-
\$804.09	-	-	-
			-
			Custom Len.
			See Web
N MALE TO N FEMALE			
Corrugated Cable Assemblies			
SPP-250-LLPL Coax, 50 Ohm			
Part No. PE3C4138	0.280" dia.	6 dB/100ft	650 W
1 piece price shown. See web or call for volume pricing.			
12"	24"	36"	48"
\$87.70	\$93.28	\$98.86	\$104.44
			\$110.02
			50CM Custom Len.
			See Web
Precision Formable Cable Assemblies			
PE-SR402FLJ Coax, 50 Ohm			
Part No. PE39468	0.161" dia.	12 dB/100ft	450 W
1 piece price shown. See web or call for volume pricing.			
6"	9"	12"	18"
\$82.38	\$85.30	\$87.33	\$86.16
			\$89.93
			-
			Custom Len.
			See Web
PE-80TEST Coax, 50 Ohm			
Part No. PE3TC0104	0.195" dia.	dB/100ft	W
1 piece price shown. See web or call for volume pricing.			
24"	48"	72"	-
\$383.91	\$469.65	\$555.40	-
			-
			Custom Len.
			See Web
Low Loss Flexible Cable Assemblies			
PE-C195 Coax, 50 Ohm			
Part No. PE37948	0.195" dia.	11 dB/100ft	150 W
1 piece price shown. See web or call for volume pricing.			
36"	48"	60"	72"
\$32.89	\$31.70	\$32.42	\$33.13
			\$35.98
			-
			Custom Len.
			See Web
PE-C240 Coax, 50 Ohm			



Cable Assemblies See Our Website For Current Pricing & Real-Time Stock Availability!

*Coax Performance at 1 GHz Notes: Cable assembly max frequency may be lower than connector or coax max frequency

For our complete selection of cable assemblies, please visit our website

Part No.	Cable Dia.				Attn. @ 1 GHz	Power @ 1 GHz
PE37949	1 piece price shown. See web or call for volume pricing.				0.240" dia.	9 dB/100ft 250 W
	36"	48"	60"	72"	120"	Custom Len.
	\$47.34	\$48.31	\$49.28	\$50.25	\$54.12	See Web
PE-C400 Coax, 50 Ohm						
PE34716	1 piece price shown. See web or call for volume pricing.				0.400" dia.	4 dB/100ft 550 W
	12"	24"	36"	48"	60"	Custom Len.
	\$66.58	\$67.85	\$69.10	\$70.36	\$76.64	See Web
PE37950	1 piece price shown. See web or call for volume pricing.				0.400" dia.	4 dB/100ft 550 W
	36"	48"	60"	72"	120"	Custom Len.
	\$69.51	\$70.83	\$72.14	\$73.46	\$78.73	See Web
PE-C600 Coax, 50 Ohm						
PE37951	1 piece price shown. See web or call for volume pricing.				0.590" dia.	3 dB/100ft 900 W
	36"	48"	72"	120"	-	Custom Len.
	\$110.03	\$112.43	\$124.93	\$126.77	-	See Web
LMR-400 Coax, 50 Ohm						
PE3W00676	1 piece price shown. See web or call for volume pricing.				0.405" dia.	dB/100ft W
	12"	24"	36"	48"	60"	50CM Custom Len.
	\$57.31	\$58.65	\$59.99	\$61.33	\$62.67	\$58.17 See Web
PE-SF200LL Coax, 50 Ohm						
PE3TC1103	1 piece price shown. See web or call for volume pricing.				0.185" dia.	dB/100ft W
	24"	36"	48"	72"	100CM 200CM	Custom Len.
	\$75.75	\$87.02	\$98.28	\$120.79	\$90.17	\$127.12 See Web
Low PIM Formable Cable Assemblies						
PE-SR402FLJ Low PIM Coax, 50 Ohm						
PE3C2001	1 piece price shown. See web or call for volume pricing.				0.161" dia.	dB/100ft W
	100CM	200CM	-	-	-	Custom Len.
	\$72.80	\$93.24	-	-	-	See Web
Low Loss Test Flexible Cable Assemblies						
PE-P300LL Coax, 50 Ohm						
PE3C3241	1 piece price shown. See web or call for volume pricing.				0.300" dia.	6 dB/100ft W
	12"	24"	36"	48"	60"	50CM Custom Len.
	\$232.13	\$257.34	\$282.55	\$307.74	\$332.95	\$248.28 See Web
PE331	1 piece price shown. See web or call for volume pricing.				0.300" dia.	5 dB/100ft W
	12"	24"	36"	48"	60"	50CM Custom Len.
	\$370.75	\$418.94	\$422.61	\$448.56	\$474.49	\$387.36 See Web
Standard Formable Cable Assemblies						
PE-SR402FL Coax, 50 Ohm						
PE3485	1 piece price shown. See web or call for volume pricing.				" dia.	12 dB/100ft 450 W
	6"	12"	18"	24"	36"	48"
	\$83.98	\$87.64	\$91.32	\$100.98	\$102.24	\$109.54 See Web
Standard Flexible Cable Assemblies						
RG58C/U Coax, 50 Ohm						
PE3714	1 piece price shown. See web or call for volume pricing.				0.195" dia.	20 dB/100ft 44 W
	12"	24"	36"	48"	60"	72"
	\$51.10	\$56.00	\$56.81	\$53.30	\$54.04	\$54.78 See Web
RG142B/U Coax, 50 Ohm						
PE3996	1 piece price shown. See web or call for volume pricing.				0.195" dia.	13 dB/100ft 650 W
	12"	24"	36"	48"	60"	72"
	\$54.66	\$60.74	\$66.82	\$73.25	\$79.44	\$85.64 See Web
RG213/U Coax, 50 Ohm						
PE3232	1 piece price shown. See web or call for volume pricing.				0.405" dia.	9 dB/100ft 190 W
	12"	24"	36"	48"	60"	72"
	\$65.82	\$67.61	\$69.39	\$71.29	\$73.11	\$74.93 See Web
RG214/U Coax, 50 Ohm						
PE3650	1 piece price shown. See web or call for volume pricing.				0.425" dia.	7 dB/100ft 190 W
	12"	24"	36"	48"	60"	72"
	\$71.96	\$79.74	\$87.53	\$95.75	\$97.20	\$111.62 See Web
RG217/U Coax, 50 Ohm						
PE34274	1 piece price shown. See web or call for volume pricing.				0.545" dia.	6 dB/100ft 260 W
	12"	24"	36"	48"	60"	72"
	\$128.60	\$133.00	\$137.42	\$141.81	\$146.22	\$150.62 See Web
RG218/U Coax, 50 Ohm						
PE34276	1 piece price shown. See web or call for volume pricing.				0.870" dia.	4 dB/100ft 560 W
	12"	24"	36"	48"	60"	72"
	\$192.25	\$203.43	\$214.52	\$225.68	\$236.85	\$265.91 See Web
RG223/U Coax, 50 Ohm						

Part No.	Cable Dia.				Attn. @ 1 GHz	Power @ 1 GHz
PE3667	1 piece price shown. See web or call for volume pricing.				0.210" dia.	13 dB/100ft 53 W
	12"	24"	36"	48"	60"	72"
	\$49.72	\$49.81	\$52.71	\$59.23	\$62.41	\$65.59 See Web
RG225/U Coax, 50 Ohm						
PE33728	1 piece price shown. See web or call for volume pricing.				0.430" dia.	dB/100ft 1700 W
	12"	24"	36"	48"	60"	72"
	\$88.07	\$120.66	\$153.24	\$185.83	\$218.42	\$251.00 See Web
RG316/U Coax, 50 Ohm						
PE3986	1 piece price shown. See web or call for volume pricing.				0.098" dia.	38 dB/100ft 160 W
	12"	24"	36"	48"	60"	72"
	\$61.79	\$68.63	\$67.58	\$70.46	\$73.34	\$76.23 See Web
RG393/U Coax, 50 Ohm						
PE3977	1 piece price shown. See web or call for volume pricing.				0.390" dia.	9 dB/100ft 1700 W
	12"	24"	36"	48"	60"	72"
	\$79.87	\$96.27	\$112.68	\$130.04	\$137.22	\$152.68 See Web
RG400/U Coax, 50 Ohm						
PE3617	1 piece price shown. See web or call for volume pricing.				0.195" dia.	15 dB/100ft 650 W
	12"	24"	36"	48"	60"	72"
	\$63.24	\$70.63	\$78.03	\$85.85	\$93.40	\$94.50 See Web
PE3W07899	1 piece price shown. See web or call for volume pricing.				0.195" dia.	15 dB/100ft 600 W
	12"	18"	24"	36"	48"	60"
	\$58.65	\$62.31	\$65.98	\$73.31	\$80.64	\$87.97 See Web
PE-FF430 Coax, 50 Ohm						
PE3C4004	1 piece price shown. See web or call for volume pricing.				0.430" dia.	dB/100ft W
	60"	144"	-	-	-	Custom Len.
	\$494.77	\$729.86	-	-	-	See Web
PE3C4007	1 piece price shown. See web or call for volume pricing.				0.430" dia.	dB/100ft W
	100CM	-	-	-	-	Custom Len.
	\$637.06	-	-	-	-	See Web
PE-VNA-R Coax, 50 Ohm						
PE3VNA1804	1 piece price shown. See web or call for volume pricing.				0.430" dia.	dB/100ft W
	24"	48"	-	-	-	Custom Len.
	\$806.69	\$896.00	-	-	-	See Web
Standard Semi-Rigid Cable Assemblies						
PE-SR402AL Coax, 50 Ohm						
PE34289	1 piece price shown. See web or call for volume pricing.				0.141" dia.	13 dB/100ft 450 W
	6"	12"	18"	24"	36"	48"
	\$84.95	\$89.51	\$94.07	\$98.62	\$107.74	\$116.88 See Web
RG401/U Coax, 50 Ohm						
PE3979	1 piece price shown. See web or call for volume pricing.				" dia.	8 dB/100ft 870 W
	6"	12"	18"	24"	36"	48"
	\$103.48	\$114.10	\$124.79	\$135.41	\$170.84	\$178.03 See Web
RG402/U Coax, 50 Ohm						
PE3829	1 piece price shown. See web or call for volume pricing.				" dia.	12 dB/100ft 650 W
	6"	12"	18"	24"	36"	48"
	\$92.71	\$92.71	\$96.37	\$100.01	\$107.32	\$114.62 See Web
RG405/U Coax, 50 Ohm						
PE3921	1 piece price shown. See web or call for volume pricing.				" dia.	22 dB/100ft 130 W
	6"	12"	18"	24"	36"	48"
	\$88.54	\$91.85	\$95.21	\$98.52	\$105.17	\$111.83 See Web
PE-SR401AL-STRAIGHT Coax, 50 Ohm						
PE3988	1 piece price shown. See web or call for volume pricing.				0.250" dia.	8 dB/100ft 1400 W
	6"	12"	18"	24"	36"	48"
	\$101.63	\$110.39	\$119.21	\$127.98	\$145.56	\$163.14 See Web
N MALE TO N FEMALE BULKHEAD						
SEE MOUNTING HOLE SECTION ON PAGE 369						
Flexible Cable Assemblies						
LMR-400-UF Coax, 50 Ohm						
PE3W02547	1 piece price shown. See web or call for volume pricing.				0.405" dia.	5 dB/100ft W
	12"	24"	36"	48"	60"	50CM Custom Len.
	\$53.77	\$65.09	\$67.72	\$70.35	\$72.98	\$64.16 See Web
Low Loss Flexible Cable Assemblies						
PE-C240 Coax, 50 Ohm						
PE38672	1 piece price shown. See web or call for volume pricing.				0.240" dia.	9 dB/100ft 250 W
	36"	48"	60"	72"	120"	Custom Len.
	\$52.95	\$50.72	\$52.54	\$56.47	\$66.58	See Web

Cable Assemblies

See Our Website For Current Pricing & Real-Time Stock Availability!



For Custom Lengths, Metric Lengths or Special Configurations, Please call (949) 261-1920

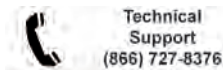

Technical Support
(866) 727-8376



Same-Day Shipping,
Even Custom
Cable Assemblies

For our complete selection of cable assemblies, please visit our website

Cable Assemblies

See Our Website For Current Pricing & Real-Time Stock Availability!

PE-P142LL Coax, 50 Ohm						
Part No. PE344	Cable Dia.			Attn. @ 1 GHz	Power @ 1 GHz	
1 piece price shown. See web or call for volume pricing.						
12"	24"	36"	48"	0.195" dia.	10 dB/100ft	W
\$182.82	\$199.06	\$215.30	\$231.53	\$247.77	50CM	Custom Len.
					\$193.22	See Web
PE-P142LL-27478 Coax, 50 Ohm						
Part No. PE3M0175	Cable Dia.			Attn. @ 1 GHz	Power @ 1 GHz	
1 piece price shown. See web or call for volume pricing.						
12"	18"	24"	36"	0.195" dia.	8 dB/100ft	W
\$457.25	\$465.73	\$474.21	\$491.17	\$508.12	60"	Custom Len.
					\$525.08	See Web
PE-P160LL-27478 Coax, 50 Ohm						
Part No. PE3M0220	Cable Dia.			Attn. @ 1 GHz	Power @ 1 GHz	
1 piece price shown. See web or call for volume pricing.						
8"	12"	18"	24"	0.160" dia.	dB/100ft	W
\$442.62	\$447.52	\$454.87	\$462.22	\$469.20	30"	Custom Len.
					\$476.92	See Web
PE-P300LL-27478 Coax, 50 Ohm						
Part No. PE3M0248	Cable Dia.			Attn. @ 1 GHz	Power @ 1 GHz	
1 piece price shown. See web or call for volume pricing.						
12"	18"	24"	36"	0.300" dia.	dB/100ft	W
\$493.73	\$507.88	\$522.04	\$550.34	\$578.64	48"	Custom Len.
					\$606.94	See Web
PE-P160LL Coax, 50 Ohm						
Part No. PE3C5257	Cable Dia.			Attn. @ 1 GHz	Power @ 1 GHz	
1 piece price shown. See web or call for volume pricing.						
12"	24"	36"	48"	0.160" dia.	dB/100ft	W
\$231.73	\$252.45	\$273.15	\$293.87	\$314.58	50CM	Custom Len.
					\$245.00	See Web
Standard Formable Cable Assemblies						
PE-SR401FL Coax, 50 Ohm						
Part No. PE34150	Cable Dia.			Attn. @ 1 GHz	Power @ 1 GHz	
1 piece price shown. See web or call for volume pricing.						
6"	12"	18"	24"	* dia.	8 dB/100ft	1400 W
\$101.74	\$109.24	\$116.69	\$124.19	\$139.13	48"	Custom Len.
					\$154.08	See Web
PE-SR402FL Coax, 50 Ohm						
Part No. PE3488	Cable Dia.			Attn. @ 1 GHz	Power @ 1 GHz	
1 piece price shown. See web or call for volume pricing.						
6"	12"	18"	24"	* dia.	12 dB/100ft	450 W
\$91.70	\$91.70	\$95.47	\$99.23	\$106.78	36"	Custom Len.
					\$114.32	See Web
Standard Flexible Cable Assemblies						
RG8/U Coax, 50 Ohm						
Part No. PE3966	Cable Dia.			Attn. @ 1 GHz	Power @ 1 GHz	
1 piece price shown. See web or call for volume pricing.						
12"	24"	36"	48"	0.405" dia.	8 dB/100ft	190 W
\$79.95	\$78.25	\$81.08	\$83.92	\$86.75	60"	Custom Len.
					\$89.58	See Web
RG58C/U Coax, 50 Ohm						
Part No. PE3320	Cable Dia.			Attn. @ 1 GHz	Power @ 1 GHz	
1 piece price shown. See web or call for volume pricing.						
12"	24"	36"	48"	0.195" dia.	20 dB/100ft	44 W
\$56.02	\$56.84	\$54.32	\$58.52	\$55.79	60"	Custom Len.
					\$56.53	See Web
RG142B/U Coax, 50 Ohm						
Part No. PE3034	Cable Dia.			Attn. @ 1 GHz	Power @ 1 GHz	
1 piece price shown. See web or call for volume pricing.						
12"	24"	36"	48"	0.195" dia.	13 dB/100ft	W
\$57.33	\$63.41	\$69.49	\$75.93	\$82.12	72"	Custom Len.
					\$88.32	See Web
RG188A/U Coax, 50 Ohm						
Part No. PE34181	Cable Dia.			Attn. @ 1 GHz	Power @ 1 GHz	
1 piece price shown. See web or call for volume pricing.						
12"	24"	36"	48"	0.110" dia.	26 dB/100ft	160 W
\$62.98	\$65.13	\$67.23	\$69.41	\$71.57	72"	Custom Len.
					\$73.65	See Web
RG213/U Coax, 50 Ohm						
Part No. PE33543	Cable Dia.			Attn. @ 1 GHz	Power @ 1 GHz	
1 piece price shown. See web or call for volume pricing.						
12"	24"	36"	48"	0.405" dia.	8 dB/100ft	190 W
\$74.28	\$75.93	\$77.60	\$79.25	\$80.92	72"	Custom Len.
					\$82.58	See Web
RG214/U Coax, 50 Ohm						
Part No. PE3217	Cable Dia.			Attn. @ 1 GHz	Power @ 1 GHz	
1 piece price shown. See web or call for volume pricing.						
12"	24"	36"	48"	0.425" dia.	7 dB/100ft	170 W
\$69.61	\$77.40	\$85.18	\$87.66	\$94.99	72"	Custom Len.
					\$102.30	See Web
RG223/U Coax, 50 Ohm						
Part No. PE3686	Cable Dia.			Attn. @ 1 GHz	Power @ 1 GHz	
1 piece price shown. See web or call for volume pricing.						
12"	24"	36"	48"	0.210" dia.	13 dB/100ft	53 W
\$52.27	\$55.18	\$58.08	\$65.98	\$63.87	72"	Custom Len.
					\$72.32	See Web
RG225/U Coax, 50 Ohm						
Part No. PE34194	Cable Dia.			Attn. @ 1 GHz	Power @ 1 GHz	
1 piece price shown. See web or call for volume pricing.						
12"	24"	36"	48"	0.430" dia.	dB/100ft	1700 W
\$87.17	\$119.77	\$152.36	\$184.94	\$217.53	72"	Custom Len.
					\$250.12	See Web
RG316/U Coax, 50 Ohm						
Part No. PE33534	Cable Dia.			Attn. @ 1 GHz	Power @ 1 GHz	
1 piece price shown. See web or call for volume pricing.						
12"	24"	36"	48"	0.098" dia.	38 dB/100ft	160 W
\$67.72	\$70.60	\$73.50	\$76.39	\$84.53	72"	Custom Len.
					\$82.15	See Web

RG393/U Coax, 50 Ohm						
Part No. PE33530	Cable Dia.			Attn. @ 1 GHz	Power @ 1 GHz	
1 piece price shown. See web or call for volume pricing.						
12"	24"	36"	48"	0.390" dia.	8 dB/100ft	1700 W
\$72.93	\$88.39	\$103.86	\$119.33	\$134.79	72"	Custom Len.
					\$150.26	See Web
RG400/U Coax, 50 Ohm						
Part No. PE3227	Cable Dia.			Attn. @ 1 GHz	Power @ 1 GHz	
1 piece price shown. See web or call for volume pricing.						
12"	24"	36"	48"	0.195" dia.	15 dB/100ft	600 W
\$68.22	\$75.62	\$77.10	\$90.84	\$91.05	72"	Custom Len.
					\$105.92	See Web
PE-P141 Coax, 50 Ohm						
Part No. PE3C3255	Cable Dia.			Attn. @ 1 GHz	Power @ 1 GHz	
1 piece price shown. See web or call for volume pricing.						
12"	24"	36"	48"	0.163" dia.	11 dB/100ft	550 W
\$83.35	\$94.37	\$105.40	\$116.42	\$127.44	60"	Custom Len.
					\$90.41	See Web
Standard Semi-Rigid Cable Assemblies						
PE-SR405AL Coax, 50 Ohm						
Part No. PE34161	Cable Dia.			Attn. @ 1 GHz	Power @ 1 GHz	
1 piece price shown. See web or call for volume pricing.						
6"	12"	18"	24"	* dia.	23 dB/100ft	130 W
\$97.43	\$101.63	\$105.82	\$109.97	\$118.38	48"	Custom Len.
					\$126.72	See Web
RG401/U Coax, 50 Ohm						
Part No. PE3983	Cable Dia.			Attn. @ 1 GHz	Power @ 1 GHz	
1 piece price shown. See web or call for volume pricing.						
6"	12"	18"	24"	* dia.	8 dB/100ft	870 W
\$122.49	\$122.49	\$133.45	\$144.43	\$166.38	48"	Custom Len.
					\$188.32	See Web
RG402/U Coax, 50 Ohm						
Part No. PE3C3286	Cable Dia.			Attn. @ 1 GHz	Power @ 1 GHz	
1 piece price shown. See web or call for volume pricing.						
12"	24"	36"	48"	* dia.	60"	39.37"
\$70.27	\$77.86	\$85.46	\$93.05	\$100.65	Call	See Web
PE-SR405AL Coax, 50 Ohm						
Part No. PE3830	Cable Dia.			Attn. @ 1 GHz	Power @ 1 GHz	
1 piece price shown. See web or call for volume pricing.						
6"	12"	18"	24"	* dia.	12 dB/100ft	650 W
\$84.69	\$84.69	\$88.35	\$97.59	\$99.31	48"	Custom Len.
					\$106.60	See Web
RG405/U Coax, 50 Ohm						
Part No. PE3922	Cable Dia.			Attn. @ 1 GHz	Power @ 1 GHz	
1 piece price shown. See web or call for volume pricing.						
6"	12"	18"	24"	* dia.	22 dB/100ft	130 W
\$108.63	\$105.88	\$115.95	\$112.76	\$119.63	48"	Custom Len.
					\$126.50	See Web
PE-SR401AL-STRAIGHT Coax, 50 Ohm						
Part No. PE3993	Cable Dia.			Attn. @ 1 GHz	Power @ 1 GHz	
1 piece price shown. See web or call for volume pricing.						
6"	12"	18"	24"	0.250" dia.	8 dB/100ft	1400 W
\$103.07	\$111.90	\$120.66	\$129.48	\$147.06	48"	Custom Len.
					\$164.65	See Web
N MALE TO N FEMALE 4 HOLE FLANGE						
SEE MOUNTING HOLE SECTION ON PAGE 369						
Low Loss Flexible Cable Assemblies						
LMR-195 Coax, 50 Ohm						
Part No. PE3W02012	Cable Dia.			Attn. @ 1 GHz	Power @ 1 GHz	
1 piece price shown. See web or call for volume pricing.						
12"	24"	36"	48"	0.195" dia.	12 dB/100ft	W
\$46.89	\$47.62	\$48.34	\$49.07	\$49.80	50CM	Custom Len.
					\$47.36	See Web
N MALE TO QMA MALE						
Corrugated Cable Assemblies						
SPP-250-LLPL Coax, 50 Ohm						
Part No. PE3C5868	Cable Dia.			Attn. @ 1 GHz	Power @ 1 GHz	
1 piece price shown. See web or call for volume pricing.						
12"	24"	36"	48"	0.280" dia.	6 dB/100ft	650 W
\$75.40	\$80.98	\$86.56	\$92.14	\$97.72	50CM	Custom Len.
					\$78.97	See Web
N MALE TO QMA MALE RIGHT ANGLE						
Low Loss Flexible Cable Assemblies						
LMR-195 Coax, 50 Ohm						
Part No. PE3C0049	Cable Dia.			Attn. @ 1 GHz	Power @ 1 GHz	
1 piece price shown. See web or call for volume pricing.						
12"	24"	36"	48"	0.195" dia.	12 dB/100ft	W
\$48.41	\$51.09	\$51.85	\$52.64	\$53.39	-	Custom Len.
					-	See Web
LMR-240-UF Coax, 50 Ohm						
Part No. PE3W08119	Cable Dia.			Attn. @ 1 GHz	Power @ 1 GHz	
1 piece price shown. See web or call for volume pricing.						
12"	18"	24"	36"	0.240" dia.	9 dB/100ft	W
\$46.80	\$47.45	\$48.10	\$49.40	\$50.70	60"	Custom Len.
					\$52.00	See Web

*Coax Performance at 1 GHz Notes: Cable assembly max frequency may be lower than connector or coax max frequency

For our complete selection of cable assemblies, please visit our website

Low PIM Corrugated Cable Assemblies							
SPP-250-LLPL Coax, 50 Ohm							
Part No. PE3C5874	Cable Dia.			Attn. @ 1 GHz	Power @ 1 GHz		
1 piece price shown. See web or call for volume pricing.							
12"	24"	36"	48"	0.280" dia.	dB/100ft	W	
\$77.57	\$83.15	\$88.73	\$94.31	60"	50CM	Custom Len.	
				\$99.89	\$81.15	See Web	

N MALE TO QMA FEMALE



Low PIM Corrugated Cable Assemblies							
SPP-250-LLPL Coax, 50 Ohm							
Part No. PE3C5862	Cable Dia.			Attn. @ 1 GHz	Power @ 1 GHz		
1 piece price shown. See web or call for volume pricing.							
12"	24"	36"	48"	0.280" dia.	dB/100ft	W	
\$71.81	\$77.38	\$82.96	\$88.54	60"	50CM	Custom Len.	
				\$94.12	\$75.38	See Web	

N MALE TO QN MALE



Low Loss Flexible Cable Assemblies							
PE-C195 Coax, 50 Ohm							
Part No. PE38453	Cable Dia.			Attn. @ 1 GHz	Power @ 1 GHz		
1 piece price shown. See web or call for volume pricing.							
12"	24"	36"	48"	0.195" dia.	11 dB/100ft	150 W	
\$63.97	\$64.68	\$65.39	\$70.19	60"	72"	Custom Len.	
				\$66.83	\$71.79	See Web	

Standard Flexible Cable Assemblies

RG58C/U Coax, 50 Ohm							
Part No. PE38452	Cable Dia.			Attn. @ 1 GHz	Power @ 1 GHz		
1 piece price shown. See web or call for volume pricing.							
12"	24"	36"	48"	0.195" dia.	20 dB/100ft	44 W	
\$62.80	\$58.43	\$59.24	\$65.02	60"	72"	Custom Len.	
				\$65.73	\$66.45	See Web	

RG213/U Coax, 50 Ohm

Part No. PE38450	Cable Dia.			Attn. @ 1 GHz	Power @ 1 GHz		
1 piece price shown. See web or call for volume pricing.							
12"	24"	36"	48"	0.405" dia.	8 dB/100ft	190 W	
\$104.51	\$106.19	\$107.87	\$109.54	60"	72"	Custom Len.	
				\$111.18	\$112.85	See Web	

RG223/U Coax, 50 Ohm

Part No. PE38451	Cable Dia.			Attn. @ 1 GHz	Power @ 1 GHz		
1 piece price shown. See web or call for volume pricing.							
12"	24"	36"	48"	0.210" dia.	13 dB/100ft	53 W	
\$66.39	\$69.28	\$72.19	\$75.09	60"	72"	Custom Len.	
				\$77.99	\$80.89	See Web	

N MALE TO QN MALE RIGHT ANGLE



Low Loss Flexible Cable Assemblies							
PE-C195 Coax, 50 Ohm							
Part No. PE38490	Cable Dia.			Attn. @ 1 GHz	Power @ 1 GHz		
1 piece price shown. See web or call for volume pricing.							
12"	24"	36"	48"	0.195" dia.	11 dB/100ft	150 W	
\$67.66	\$68.38	\$69.09	\$69.80	60"	72"	Custom Len.	
				\$70.52	\$71.23	See Web	

LMR-195 Coax, 50 Ohm

Part No. PE3C0059	Cable Dia.			Attn. @ 1 GHz	Power @ 1 GHz		
1 piece price shown. See web or call for volume pricing.							
12"	24"	36"	48"	0.195" dia.	12 dB/100ft	W	
\$59.98	\$60.69	\$61.38	\$62.07	60"	-	Custom Len.	
				\$62.77	-	See Web	

Standard Flexible Cable Assemblies

RG58C/U Coax, 50 Ohm							
Part No. PE38489	Cable Dia.			Attn. @ 1 GHz	Power @ 1 GHz		
1 piece price shown. See web or call for volume pricing.							
12"	24"	36"	48"	0.195" dia.	20 dB/100ft	44 W	
\$80.45	\$81.18	\$81.91	\$82.65	60"	72"	Custom Len.	
				\$83.39	\$84.13	See Web	

RG223/U Coax, 50 Ohm

Part No. PE38492	Cable Dia.			Attn. @ 1 GHz	Power @ 1 GHz		
1 piece price shown. See web or call for volume pricing.							
12"	24"	36"	48"	0.210" dia.	13 dB/100ft	53 W	
\$67.12	\$74.26	\$77.37	\$75.89	60"	72"	Custom Len.	
				\$78.77	\$81.71	See Web	

N MALE TO SHV PLUG



Standard Flexible Cable Assemblies							
RG223/U Coax, 50 Ohm							
Part No. PE3W04051	Cable Dia.			Attn. @ 1 GHz	Power @ 1 GHz		
1 piece price shown. See web or call for volume pricing.							
12"	24"	36"	48"	0.209" dia.	13 dB/100ft	50 W	
\$61.60	\$64.84	\$68.09	\$71.33	60"	50CM	Custom Len.	
				\$74.57	\$63.67	See Web	

N MALE TO SMA MALE							
1 piece price shown. See web or call for volume pricing.							
12"	24"	36"	48"	0.160" dia.	dB/100ft	W	
\$205.44	\$226.16	\$246.87	\$267.58	60"	50CM	Custom Len.	
				\$288.29	\$218.71	See Web	



Low Loss Flexible Cable Assemblies							
PE-P160LL Coax, 50 Ohm							
Part No. PE3C5273	Cable Dia.			Attn. @ 1 GHz	Power @ 1 GHz		
1 piece price shown. See web or call for volume pricing.							
12"	24"	36"	48"	0.160" dia.	dB/100ft	W	
\$205.44	\$226.16	\$246.87	\$267.58	60"	50CM	Custom Len.	
				\$288.29	\$218.71	See Web	

Low PIM Formable Cable Assemblies							
PE-SR402FLJ Low PIM Coax, 50 Ohm							
Part No. PE3C2006	Cable Dia.			Attn. @ 1 GHz	Power @ 1 GHz		
1 piece price shown. See web or call for volume pricing.							
100CM	200CM	-	-	0.161" dia.	dB/100ft	W	
\$76.69	\$99.59	-	-	-	-	Custom Len.	
				-	-	See Web	

Low PIM Corrugated Cable Assemblies							
SPP-250-LLPL Coax, 50 Ohm							
Part No. PE3C5887	Cable Dia.			Attn. @ 1 GHz	Power @ 1 GHz		
1 piece price shown. See web or call for volume pricing.							
12"	24"	36"	48"	0.280" dia.	dB/100ft	W	
\$68.18	\$73.76	\$79.34	\$84.92	60"	50CM	Custom Len.	
				\$90.50	\$71.75	See Web	

Low Loss Test Flexible Cable Assemblies							
PE-P300LL Coax, 50 Ohm							
Part No. PE332	Cable Dia.			Attn. @ 1 GHz	Power @ 1 GHz		
1 piece price shown. See web or call for volume pricing.							
12"	24"	36"	48"	0.300" dia.	5 dB/100ft	W	
\$263.44	\$289.38	\$366.65	\$341.25	60"	600"	Custom Len.	
				\$369.59	\$263.44	See Web	

Standard Flexible Cable Assemblies							
RG58C/U Coax, 50 Ohm							
Part No. PE3662	Cable Dia.			Attn. @ 1 GHz	Power @ 1 GHz		
1 piece price shown. See web or call for volume pricing.							
12"	24"	36"	48"	0.195" dia.	20 dB/100ft	44 W	
\$42.38	\$43.19	\$44.74	\$44.86	60"	72"	Custom Len.	
				\$46.18	\$46.53	See Web	

Standard Flexible Cable Assemblies							
RG316/U Coax, 50 Ohm							
Part No. PE3234	Cable Dia.			Attn. @ 1 GHz	Power @ 1 GHz		
1 piece price shown. See web or call for volume pricing.							
12"	24"	36"	48"	0.102" dia.	38 dB/100ft	W	
\$49.14	\$52.27	\$56.50	\$58.70	60"	72"	Custom Len.	
				\$62.28	\$65.07	See Web	

Low Loss Flexible Cable Assemblies							
PE-P141 Coax, 50 Ohm							
Part No. PE354	Cable Dia.			Attn. @ 1 GHz	Power @ 1 GHz		
1 piece price shown. See web or call for volume pricing.							
12"	24"	36"	48"	0.163" dia.	11 dB/100ft	600 W	
\$167.12	\$178.47	\$189.83	\$201.85	60"	72"	Custom Len.	
				\$213.42	\$225.00	See Web	

Low Loss Flexible Cable Assemblies							
PE-VNA-R Coax, 50 Ohm							
Part No. PE3VNA1805	Cable Dia.			Attn. @ 1 GHz	Power @ 1 GHz		
1 piece price shown. See web or call for volume pricing.							
24"	36"	48"	-	0.430" dia.	dB/100ft	W	
\$870.00	\$918.70	\$967.40	-	-	-	Custom Len.	
				-	-	See Web	

Standard Flexible Cable Assemblies							
RG401/U Coax, 50 Ohm							
Part No. PE3W04229	Cable Dia.			Attn. @ 1 GHz	Power @ 1 GHz		
1 piece price shown. See web or call for volume pricing.							
12"	24"	36"	48"	* dia.	8 dB/100ft	1400 W	
\$103.34	\$126.39	\$149.41	\$172.51	60"	50CM	Custom Len.	
				\$195.56	\$118.11	See Web	

Standard Flexible Cable Assemblies							
RG402/U Coax, 50 Ohm							
Part No. PE3887	Cable Dia.			Attn. @ 1 GHz	Power @ 1 GHz		
1 piece price shown. See web or call for volume pricing.							
6"	12"	18"	24"	* dia.	11 dB/100ft	450 W	
\$69.06	\$67.46	\$76.77	\$80.68	36"	48"	Custom Len.	
				\$82.07	\$89.37	See Web	

Low Loss Flexible Cable Assemblies							
PE-P160LL Coax, 50 Ohm							
Part No. PE3C5275	Cable Dia.			Attn. @ 1 GHz	Power @ 1 GHz		
1 piece price shown. See web or call for volume pricing.							
12"	24"	36"	48"	0.160" dia.	dB/100ft	W	
\$242.55	\$263.27	\$283.98	\$304.70	60"	50CM	Custom Len.	
				\$325.40	\$255.82	See Web	



Cable Assemblies

See Our Website For Current Pricing & Real-Time Stock Availability!

For Custom Lengths, Metric Lengths or Special Configurations, Please call (949) 261-1920

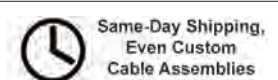

For our complete selection of cable assemblies, please visit our website

Cable Assemblies

See Our Website For Current Pricing & Real-Time Stock Availability!

LMR-240-UF Coax, 50 Ohm						
Part No. PE3W06417	Cable Dia.			Attn. @ 1 GHz	Power @ 1 GHz	
1 piece price shown. See web or call for volume pricing.						
12"	24"	36"	48"	60"	50CM	Custom Len.
\$53.51	\$54.85	\$56.20	\$57.55	\$58.90	\$54.37	See Web
Low PIM Corrugated Cable Assemblies						
SPP-250-LLPL Coax, 50 Ohm						
Part No. PE3C5892	Cable Dia.			Attn. @ 1 GHz	Power @ 1 GHz	
1 piece price shown. See web or call for volume pricing.						
12"	24"	36"	48"	60"	50CM	Custom Len.
\$69.63	\$75.21	\$80.79	\$86.37	\$91.95	\$73.21	See Web
N MALE TO SMA FEMALE						
Low Loss Flexible Cable Assemblies						
PE-P142LL Coax, 50 Ohm						
Part No. PE3C1128	Cable Dia.			Attn. @ 1 GHz	Power @ 1 GHz	
1 piece price shown. See web or call for volume pricing.						
12"	24"	36"	48"	60"	50CM	Custom Len.
\$157.67	\$173.90	\$190.14	\$206.38	\$222.62	\$168.08	See Web
Low PIM Corrugated Cable Assemblies						
SPP-250-LLPL Coax, 50 Ohm						
Part No. PE3C5881	Cable Dia.			Attn. @ 1 GHz	Power @ 1 GHz	
1 piece price shown. See web or call for volume pricing.						
12"	24"	36"	48"	60"	50CM	Custom Len.
\$68.91	\$74.49	\$80.07	\$85.64	\$91.22	\$72.48	See Web
Standard Flexible Cable Assemblies						
PE-FF430 Coax, 50 Ohm						
Part No. PE3C4009	Cable Dia.			Attn. @ 1 GHz	Power @ 1 GHz	
1 piece price shown. See web or call for volume pricing.						
60"	-	-	-	-	-	Custom Len.
\$689.65	-	-	-	-	-	See Web
PE-VNA-R Coax, 50 Ohm						
Part No. PE3VNA1806	Cable Dia.			Attn. @ 1 GHz	Power @ 1 GHz	
1 piece price shown. See web or call for volume pricing.						
24"	36"	48"	-	-	-	Custom Len.
\$870.00	\$918.70	\$967.40	-	-	-	See Web
N MALE TO SMA FEMALE BULKHEAD						
SEE MOUNTING HOLE SECTION ON PAGE 369						
Low Loss Flexible Cable Assemblies						
PE-P160LL Coax, 50 Ohm						
Part No. PE3C5277	Cable Dia.			Attn. @ 1 GHz	Power @ 1 GHz	
1 piece price shown. See web or call for volume pricing.						
12"	24"	36"	48"	60"	50CM	Custom Len.
\$222.45	\$243.17	\$263.87	\$284.59	\$305.30	\$235.72	See Web
N MALE TO SSMC PLUG						
Flexible Cable Assemblies						
RG316/U Coax, 50 Ohm						
Part No. PE3C4415	Cable Dia.			Attn. @ 1 GHz	Power @ 1 GHz	
1 piece price shown. See web or call for volume pricing.						
6"	12"	18"	24"	36"	48"	Custom Len.
\$61.68	\$63.08	\$64.49	\$65.87	\$68.69	\$71.48	See Web
Low Loss Flexible Cable Assemblies						
LMR-100A-PVC Coax, 50 Ohm						
Part No. PE3C4432	Cable Dia.			Attn. @ 1 GHz	Power @ 1 GHz	
1 piece price shown. See web or call for volume pricing.						
6"	12"	18"	24"	36"	48"	Custom Len.
\$51.09	\$51.46	\$56.99	\$52.20	\$52.94	\$53.67	See Web
Standard Formable Cable Assemblies						
PE-SR405FLJ Coax, 50 Ohm						
Part No. PE3C4451	Cable Dia.			Attn. @ 1 GHz	Power @ 1 GHz	
1 piece price shown. See web or call for volume pricing.						
6"	12"	18"	24"	36"	48"	Custom Len.
\$63.02	\$66.79	\$70.55	\$74.31	\$81.83	\$89.35	See Web
Standard Flexible Cable Assemblies						
RG178B/U Coax, 50 Ohm						
Part No. PE3C4399	Cable Dia.			Attn. @ 1 GHz	Power @ 1 GHz	
1 piece price shown. See web or call for volume pricing.						
6"	12"	18"	24"	36"	48"	Custom Len.
\$73.58	\$74.06	\$74.53	\$74.98	\$75.92	\$76.85	See Web
N MALE TO SSMC PLUG RIGHT ANGLE						

Standard Flexible Cable Assemblies						
RG316/U Coax, 50 Ohm						
Part No. PE3C4416	Cable Dia.			Attn. @ 1 GHz	Power @ 1 GHz	
1 piece price shown. See web or call for volume pricing.						
6"	12"	18"	24"	36"	48"	Custom Len.
\$58.24	\$59.65	\$61.05	\$62.44	\$65.26	\$68.04	See Web
N MALE TO SSMC JACK BULKHEAD						
SEE MOUNTING HOLE SECTION ON PAGE 369						
Standard Flexible Cable Assemblies						
RG178B/U Coax, 50 Ohm						
Part No. PE3C4400	Cable Dia.			Attn. @ 1 GHz	Power @ 1 GHz	
1 piece price shown. See web or call for volume pricing.						
6"	12"	18"	24"	36"	48"	Custom Len.
\$69.61	\$70.08	\$70.55	\$78.14	\$71.95	\$72.88	See Web
N MALE TO TNC MALE						
Low Loss Flexible Cable Assemblies						
PE-C195 Coax, 50 Ohm						
Part No. PE35785	Cable Dia.			Attn. @ 1 GHz	Power @ 1 GHz	
1 piece price shown. See web or call for volume pricing.						
12"	24"	36"	48"	60"	-	Custom Len.
\$37.82	\$38.54	\$41.65	\$42.47	\$43.27	-	See Web
PE-C200 Coax, 50 Ohm						
Part No. PE36067	Cable Dia.			Attn. @ 1 GHz	Power @ 1 GHz	
1 piece price shown. See web or call for volume pricing.						
12"	24"	36"	48"	60"	-	Custom Len.
\$54.23	\$55.35	\$59.62	\$63.83	\$57.63	-	See Web
PE-C240 Coax, 50 Ohm						
Part No. PE36958	Cable Dia.			Attn. @ 1 GHz	Power @ 1 GHz	
1 piece price shown. See web or call for volume pricing.						
12"	24"	36"	48"	60"	-	Custom Len.
\$49.43	\$54.52	\$55.65	\$56.84	\$58.01	-	See Web
PE-C300 Coax, 50 Ohm						
Part No. PE37980	Cable Dia.			Attn. @ 1 GHz	Power @ 1 GHz	
1 piece price shown. See web or call for volume pricing.						
12"	24"	36"	48"	60"	-	Custom Len.
\$59.44	\$62.28	\$65.10	\$67.94	\$70.78	-	See Web
PE-C400 Coax, 50 Ohm						
Part No. PE34801	Cable Dia.			Attn. @ 1 GHz	Power @ 1 GHz	
1 piece price shown. See web or call for volume pricing.						
12"	24"	36"	48"	60"	-	Custom Len.
\$71.09	\$72.41	\$76.66	\$79.90	\$86.27	-	See Web
LMR-400 Coax, 50 Ohm						
Part No. PE3W00013	Cable Dia.			Attn. @ 1 GHz	Power @ 1 GHz	
1 piece price shown. See web or call for volume pricing.						
12"	24"	36"	48"	60"	50CM	Custom Len.
\$49.20	\$50.54	\$51.88	\$53.22	\$54.56	\$50.06	See Web
PE-C0031						
Part No. PE3C0031	Cable Dia.			Attn. @ 1 GHz	Power @ 1 GHz	
1 piece price shown. See web or call for volume pricing.						
12"	24"	36"	48"	60"	-	Custom Len.
\$63.63	\$65.00	\$66.38	\$67.85	\$69.25	-	See Web
PE-C0109						
Part No. PE3C0109	Cable Dia.			Attn. @ 1 GHz	Power @ 1 GHz	
1 piece price shown. See web or call for volume pricing.						
12"	24"	36"	48"	60"	-	Custom Len.
\$67.92	\$73.37	\$74.76	\$72.03	\$73.39	-	See Web
PE-P142LL Coax, 50 Ohm						
Part No. PE349	Cable Dia.			Attn. @ 1 GHz	Power @ 1 GHz	
1 piece price shown. See web or call for volume pricing.						
12"	24"	36"	48"	60"	72"	Custom Len.
\$149.50	\$166.03	\$182.55	\$199.09	\$215.61	\$232.13	See Web
PE-P160LL Coax, 50 Ohm						
Part No. PE3C5267	Cable Dia.			Attn. @ 1 GHz	Power @ 1 GHz	
1 piece price shown. See web or call for volume pricing.						
12"	24"	36"	48"	60"	50CM	Custom Len.
\$205.44	\$226.16	\$246.87	\$267.58	\$288.29	\$218.71	See Web
Low Loss Test Flexible Cable Assemblies						
PE-P300LL Coax, 50 Ohm						
Part No. PE335	Cable Dia.			Attn. @ 1 GHz	Power @ 1 GHz	
1 piece price shown. See web or call for volume pricing.						
12"	24"	36"	48"	60"	50CM	Custom Len.
\$225.09	\$251.02	\$276.97	\$302.91	\$328.83	\$241.71	See Web
Standard Formable Cable Assemblies						
PE-SR402FL Coax, 50 Ohm						
Part No. PE33927	Cable Dia.			Attn. @ 1 GHz	Power @ 1 GHz	
1 piece price shown. See web or call for volume pricing.						
12"	24"	36"	48"	60"	-	Custom Len.
\$81.71	\$89.25	\$96.78	\$104.33	\$111.86	-	See Web
Standard Flexible Cable Assemblies						

*Coax Performance at 1 GHz Notes: Cable assembly max frequency may be lower than connector or coax max frequency

For our complete selection of cable assemblies, please visit our website

RG8A/U Coax, 50 Ohm						
Part No. PE33615	Cable Dia.	Attn. @ 1 GHz	Power @ 1 GHz			
1 piece price shown. See web or call for volume pricing.						
12"	24"	36"	48"	60"	72"	Custom Len.
\$69.34	\$72.41	\$71.08	\$73.91	\$76.75	\$85.00	See Web
RG8X Coax, 50 Ohm						
Part No. PE37357	Cable Dia.	Attn. @ 1 GHz	Power @ 1 GHz			
1 piece price shown. See web or call for volume pricing.						
12"	24"	36"	48"	60"	72"	Custom Len.
\$59.97	\$67.10	\$65.62	\$68.44	\$71.27	-	See Web
RG58C/U Coax, 50 Ohm						
Part No. PE3661	Cable Dia.	Attn. @ 1 GHz	Power @ 1 GHz			
1 piece price shown. See web or call for volume pricing.						
12"	24"	36"	48"	60"	72"	Custom Len.
\$44.33	\$45.14	\$45.95	\$46.82	\$44.76	\$48.48	See Web
RG142B/U Coax, 50 Ohm						
Part No. PE3652	Cable Dia.	Attn. @ 1 GHz	Power @ 1 GHz			
1 piece price shown. See web or call for volume pricing.						
12"	24"	36"	48"	60"	72"	Custom Len.
\$48.33	\$54.41	\$60.49	\$66.92	\$73.12	\$79.32	See Web
RG174A/U Coax, 50 Ohm						
Part No. PE34272	Cable Dia.	Attn. @ 1 GHz	Power @ 1 GHz			
1 piece price shown. See web or call for volume pricing.						
12"	24"	36"	48"	60"	72"	Custom Len.
\$57.98	\$58.41	\$58.85	\$59.29	\$59.72	\$60.16	See Web
RG178B/U Coax, 50 Ohm						
Part No. PE33455	Cable Dia.	Attn. @ 1 GHz	Power @ 1 GHz			
1 piece price shown. See web or call for volume pricing.						
12"	24"	36"	48"	60"	72"	Custom Len.
\$69.64	\$70.59	\$71.57	\$72.52	\$73.49	\$79.22	See Web
RG188A/U Coax, 50 Ohm						
Part No. PE33457	Cable Dia.	Attn. @ 1 GHz	Power @ 1 GHz			
1 piece price shown. See web or call for volume pricing.						
12"	24"	36"	48"	60"	72"	Custom Len.
\$59.87	\$62.08	\$64.30	\$66.53	\$68.74	\$70.96	See Web
RG213/U Coax, 50 Ohm						
Part No. PE3644	Cable Dia.	Attn. @ 1 GHz	Power @ 1 GHz			
1 piece price shown. See web or call for volume pricing.						
12"	24"	36"	48"	60"	72"	Custom Len.
\$58.34	\$65.92	\$67.59	\$69.25	\$70.91	\$72.56	See Web
RG214/U Coax, 50 Ohm						
Part No. PE3991	Cable Dia.	Attn. @ 1 GHz	Power @ 1 GHz			
1 piece price shown. See web or call for volume pricing.						
12"	24"	36"	48"	60"	72"	Custom Len.
\$80.39	\$92.99	\$95.05	\$102.38	\$109.70	\$124.87	See Web
RG223/U Coax, 50 Ohm						
Part No. PE3665	Cable Dia.	Attn. @ 1 GHz	Power @ 1 GHz			
1 piece price shown. See web or call for volume pricing.						
12"	24"	36"	48"	60"	72"	Custom Len.
\$47.31	\$50.41	\$53.53	\$56.82	\$56.22	\$63.17	See Web
RG316/U Coax, 50 Ohm						
Part No. PE3989	Cable Dia.	Attn. @ 1 GHz	Power @ 1 GHz			
1 piece price shown. See web or call for volume pricing.						
12"	24"	36"	48"	60"	72"	Custom Len.
\$65.61	\$68.74	\$71.86	\$69.42	\$72.30	\$75.19	See Web
RG316-DS Coax, 50 Ohm						
Part No. PE34266	Cable Dia.	Attn. @ 1 GHz	Power @ 1 GHz			
1 piece price shown. See web or call for volume pricing.						
12"	24"	36"	48"	60"	72"	Custom Len.
\$60.70	\$63.61	\$66.52	\$69.43	\$72.34	\$75.24	See Web
RG393/U Coax, 50 Ohm						
Part No. PE3982	Cable Dia.	Attn. @ 1 GHz	Power @ 1 GHz			
1 piece price shown. See web or call for volume pricing.						
12"	24"	36"	48"	60"	72"	Custom Len.
\$87.62	\$103.08	\$118.55	\$134.01	\$149.48	\$164.95	See Web
RG400/U Coax, 50 Ohm						
Part No. PE3666	Cable Dia.	Attn. @ 1 GHz	Power @ 1 GHz			
1 piece price shown. See web or call for volume pricing.						
12"	24"	36"	48"	60"	72"	Custom Len.
\$58.61	\$66.01	\$73.39	\$81.23	\$88.76	\$96.30	See Web
PE-FF430 Coax, 50 Ohm						
Part No. PE3C4010	Cable Dia.	Attn. @ 1 GHz	Power @ 1 GHz			
1 piece price shown. See web or call for volume pricing.						
60"	-	-	-	-	-	Custom Len.
\$964.95	-	-	-	-	-	See Web
LMR-600-DB Coax, 50 Ohm						
Part No. PE3W02356	Cable Dia.	Attn. @ 1 GHz	Power @ 1 GHz			
1 piece price shown. See web or call for volume pricing.						
12"	24"	36"	48"	60"	72"	Custom Len.
\$75.12	\$78.08	\$81.04	\$84.00	\$86.96	\$77.02	See Web

Standard Semi-Rigid Cable Assemblies

PE-SR402AL Coax, 50 Ohm

Part No. PE3W05401						
Cable Dia.	Attn. @ 1 GHz	Power @ 1 GHz				
1 piece price shown. See web or call for volume pricing.						
12"	24"	36"	48"	60"	72"	Custom Len.
\$79.04	\$88.92	\$98.80	\$108.68	\$118.56	\$85.36	See Web
RG401/U Coax, 50 Ohm						
Part No. PE3W05651	Cable Dia.	Attn. @ 1 GHz	Power @ 1 GHz			
1 piece price shown. See web or call for volume pricing.						
12"	24"	36"	48"	60"	72"	Custom Len.
\$127.32	\$150.37	\$173.43	\$196.49	\$219.54	\$142.09	See Web
RG402/U Coax, 50 Ohm						
Part No. PE3080	Cable Dia.	Attn. @ 1 GHz	Power @ 1 GHz			
1 piece price shown. See web or call for volume pricing.						
12"	24"	36"	48"	60"	72"	Custom Len.
\$86.22	\$94.04	\$95.94	\$103.25	\$110.54	-	See Web
N MALE TO TNC MALE RIGHT ANGLE						
Low Loss Flexible Cable Assemblies						
LMR-200 Coax, 50 Ohm						
Part No. PE3W02215	Cable Dia.	Attn. @ 1 GHz	Power @ 1 GHz			
1 piece price shown. See web or call for volume pricing.						
12"	24"	36"	48"	60"	72"	Custom Len.
\$52.40	\$53.19	\$53.98	\$54.77	\$55.56	\$52.91	See Web
PE-P160LL Coax, 50 Ohm						
Part No. PE3C5268	Cable Dia.	Attn. @ 1 GHz	Power @ 1 GHz			
1 piece price shown. See web or call for volume pricing.						
12"	24"	36"	48"	60"	72"	Custom Len.
\$264.21	\$284.92	\$305.63	\$326.35	\$347.06	\$277.48	See Web
N MALE TO TNC FEMALE						
Standard Flexible Cable Assemblies						
PE-FF430 Coax, 50 Ohm						
Part No. PE3C4011	Cable Dia.	Attn. @ 1 GHz	Power @ 1 GHz			
1 piece price shown. See web or call for volume pricing.						
60"	-	-	-	-	-	Custom Len.
\$964.95	-	-	-	-	-	See Web
N MALE TO TNC FEMALE BULKHEAD						
SEE MOUNTING HOLE SECTION ON PAGE 369						
Low Loss Flexible Cable Assemblies						
PE-P142LL Coax, 50 Ohm						
Part No. PE3C2276	Cable Dia.	Attn. @ 1 GHz	Power @ 1 GHz			
1 piece price shown. See web or call for volume pricing.						
12"	24"	36"	48"	60"	72"	Custom Len.
\$183.79	\$200.03	\$216.27	\$232.50	\$248.74	\$194.20	See Web
PE-P160LL Coax, 50 Ohm						
Part No. PE3C5269	Cable Dia.	Attn. @ 1 GHz	Power @ 1 GHz			
1 piece price shown. See web or call for volume pricing.						
12"	24"	36"	48"	60"	72"	Custom Len.
\$231.73	\$252.45	\$273.15	\$293.87	\$314.58	\$245.00	See Web
N MALE TO REVERSE POLARITY TNC MALE						
Low Loss Flexible Cable Assemblies						
PE-C195 Coax, 50 Ohm						
Part No. PE36362	Cable Dia.	Attn. @ 1 GHz	Power @ 1 GHz			
1 piece price shown. See web or call for volume pricing.						
12"	24"	36"	48"	60"	72"	Custom Len.
\$39.50	\$40.21	\$40.93	\$41.63	\$42.35	-	See Web
PE-C400 Coax, 50 Ohm						
Part No. PE34966	Cable Dia.	Attn. @ 1 GHz	Power @ 1 GHz			
1 piece price shown. See web or call for volume pricing.						
12"	24"	36"	48"	60"	72"	Custom Len.
\$61.80	\$63.11	\$68.48	\$65.75	\$67.07	-	See Web
Standard Flexible Cable Assemblies						
RG58C/U Coax, 50 Ohm						
Part No. PE34554	Cable Dia.	Attn. @ 1 GHz	Power @ 1 GHz			
1 piece price shown. See web or call for volume pricing.						
12"	24"	36"	48"	60"	72"	Custom Len.
\$48.00	\$52.66	\$49.47	\$50.20	\$50.94	\$51.68	See Web
RG223/U Coax, 50 Ohm						
Part No. PE35245	Cable Dia.	Attn. @ 1 GHz	Power @ 1 GHz			
1 piece price shown. See web or call for volume pricing.						
12"	24"	36"	48"	60"	72"	Custom Len.
\$42.58	\$45.46	\$51.36	\$51.34	\$54.22	\$57.16	See Web

Cable Assemblies

See Our Website For Current Pricing & Real-Time Stock Availability!

For Custom Lengths, Metric Lengths or Special Configurations, Please call (949) 261-1920

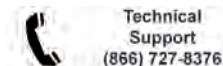

Technical Support
(866) 727-8376



Same-Day Shipping,
Even Custom
Cable Assemblies

For our complete selection of cable assemblies, please visit our website



RG316/U Coax, 50 Ohm				
Part No. PE35247	Cable Dia.	Attn. @ 1 GHz	Power @ 1 GHz	
1 piece price shown. See web or call for volume pricing.				
12"	24"	36"	48"	60"
\$62.31	\$65.20	\$68.10	\$70.98	\$73.86
				72"
				Custom Len.
				See Web
RG400/U Coax, 50 Ohm				
Part No. PE34626	Cable Dia.	Attn. @ 1 GHz	Power @ 1 GHz	
1 piece price shown. See web or call for volume pricing.				
12"	24"	36"	48"	60"
\$55.82	\$68.79	\$76.19	\$84.01	\$91.55
				Custom Len.
				See Web
N MALE TO REVERSE POLARITY TNC MALE RIGHT ANGLE				
Standard Flexible Cable Assemblies				
RG400/U Coax, 50 Ohm				
Part No. PE36283	Cable Dia.	Attn. @ 1 GHz	Power @ 1 GHz	
1 piece price shown. See web or call for volume pricing.				
12"	24"	36"	48"	60"
\$67.60	\$74.57	\$81.53	\$94.27	\$95.47
				Custom Len.
				See Web
N MALE TO UMCX PLUG RIGHT ANGLE				
Standard Flexible Cable Assemblies				
RG178B/U Coax, 50 Ohm				
Part No. PE38813	Cable Dia.	Attn. @ 1 GHz	Power @ 1 GHz	
1 piece price shown. See web or call for volume pricing.				
3"	6"	9"	12"	18"
\$71.47	\$71.47	\$71.47	\$75.76	\$76.29
				24"
				Custom Len.
				See Web
N MALE RIGHT ANGLE TO BNC MALE				
Standard Flexible Cable Assemblies				
RG400/U Coax, 50 Ohm				
Part No. PE3W06095	Cable Dia.	Attn. @ 1 GHz	Power @ 1 GHz	
1 piece price shown. See web or call for volume pricing.				
12"	24"	36"	48"	60"
\$62.48	\$70.08	\$77.70	\$85.31	\$92.93
				50CM
				Custom Len.
				See Web
N MALE RIGHT ANGLE TO N MALE				
Flexible Cable Assemblies				
LMR-195 Coax, 50 Ohm				
Part No. PE3C0120	Cable Dia.	Attn. @ 1 GHz	Power @ 1 GHz	
1 piece price shown. See web or call for volume pricing.				
12"	24"	36"	48"	60"
\$50.04	\$47.94	\$51.53	\$49.44	\$50.18
				Custom Len.
				See Web
Low PIM Corrugated Cable Assemblies				
SPP-250-LLPL Coax, 50 Ohm				
Part No. PE3C4139	Cable Dia.	Attn. @ 1 GHz	Power @ 1 GHz	
1 piece price shown. See web or call for volume pricing.				
12"	24"	36"	48"	60"
\$90.51	\$96.09	\$101.67	\$107.25	\$112.83
				50CM
				Custom Len.
				See Web
N MALE RIGHT ANGLE TO N MALE RIGHT ANGLE				
Low Loss Formable Cable Assemblies				
LMR-SW396 Coax, 50 Ohm				
Part No. PE3C0140	Cable Dia.	Attn. @ 1 GHz	Power @ 1 GHz	
1 piece price shown. See web or call for volume pricing.				
12"	24"	36"	48"	60"
\$83.98	\$86.27	\$88.54	\$90.82	\$98.66
				Custom Len.
				See Web
Low Loss Flexible Cable Assemblies				
PE-C195 Coax, 50 Ohm				
Part No. PE36910	Cable Dia.	Attn. @ 1 GHz	Power @ 1 GHz	
1 piece price shown. See web or call for volume pricing.				
12"	24"	36"	48"	60"
\$65.68	\$71.71	\$72.49	\$87.83	\$68.53
				Custom Len.
				See Web
PE-C240 Coax, 50 Ohm				
Part No. PE38699	Cable Dia.	Attn. @ 1 GHz	Power @ 1 GHz	
1 piece price shown. See web or call for volume pricing.				
36"	48"	60"	72"	120"
\$85.56	\$86.53	\$87.50	\$89.15	\$100.37
				Custom Len.
				See Web
PE-C400 Coax, 50 Ohm				



Part No. PE38194					Cable Dia.	Attn. @ 1 GHz	Power @ 1 GHz	
1 piece price shown. See web or call for volume pricing.					0.400" dia.	4 dB/100ft	550 W	
36"	48"	60"	72"		120"	-	Custom Len.	
\$115.02	\$116.59	\$118.10	\$116.64	\$135.84	-	-	See Web	
LMR-400 Coax, 50 Ohm								
Part No. PE3C0107					Cable Dia.	Attn. @ 1 GHz	Power @ 1 GHz	
1 piece price shown. See web or call for volume pricing.					0.405" dia.	4 dB/100ft	W	
12"	24"	36"	48"		60"	-	Custom Len.	
\$80.30	\$81.68	\$85.48	\$86.93	\$85.79	-	-	See Web	
LMR-195 Coax, 50 Ohm								
Part No. PE3C0119					Cable Dia.	Attn. @ 1 GHz	Power @ 1 GHz	
1 piece price shown. See web or call for volume pricing.					0.195" dia.	12 dB/100ft	W	
12"	24"	36"	48"	60"	-	-	Custom Len.	
\$51.17	\$51.93	\$52.68	\$51.93	\$52.68	-	-	See Web	
PE-P142LL Coax, 50 Ohm								
Part No. PE3C0967					Cable Dia.	Attn. @ 1 GHz	Power @ 1 GHz	
1 piece price shown. See web or call for volume pricing.					0.195" dia.	10 dB/100ft	W	
12"	24"	36"	48"	60"	50CM	Custom Len.		
\$325.84	\$342.08	\$358.30	\$374.54	\$390.78	\$336.24	See Web		
PE-P142LL-27478 Coax, 50 Ohm								
Part No. PE3M0179					Cable Dia.	Attn. @ 1 GHz	Power @ 1 GHz	
1 piece price shown. See web or call for volume pricing.					0.195" dia.	dB/100ft	W	
12"	18"	24"	36"	48"	60"	Custom Len.		
\$600.12	\$608.59	\$617.07	\$634.03	\$650.99	\$667.94	See Web		
PE-P160LL-27478 Coax, 50 Ohm								
Part No. PE3M0224					Cable Dia.	Attn. @ 1 GHz	Power @ 1 GHz	
1 piece price shown. See web or call for volume pricing.					0.160" dia.	dB/100ft	W	
8"	12"	18"	24"	30"	36"	Custom Len.		
\$536.74	\$541.64	\$549.00	\$556.34	\$563.70	\$571.04	See Web		
PE-P300LL-27478 Coax, 50 Ohm								
Part No. PE3M0252					Cable Dia.	Attn. @ 1 GHz	Power @ 1 GHz	
1 piece price shown. See web or call for volume pricing.					0.300" dia.	dB/100ft	W	
12"	18"	24"	36"	48"	60"	Custom Len.		
\$707.94	\$722.09	\$736.25	\$764.55	\$792.85	\$821.15	See Web		
PE-P160LL Coax, 50 Ohm								
Part No. PE3C5287					Cable Dia.	Attn. @ 1 GHz	Power @ 1 GHz	
1 piece price shown. See web or call for volume pricing.					0.160" dia.	dB/100ft	W	
12"	24"	36"	48"	60"	50CM	Custom Len.		
\$322.97	\$343.69	\$364.40	\$385.11	\$405.82	\$336.24	See Web		
Low PIM Corrugated Cable Assemblies								
SPP-250-LLPL Coax, 50 Ohm								
Part No. PE3C4145					Cable Dia.	Attn. @ 1 GHz	Power @ 1 GHz	
1 piece price shown. See web or call for volume pricing.					0.280" dia.	6 dB/100ft	650 W	
12"	24"	36"	48"	60"	50CM	Custom Len.		
\$93.32	\$98.90	\$104.48	\$110.06	\$115.64	\$96.90	See Web		
Low Loss Test Flexible Cable Assemblies								
PE-P300LL Coax, 50 Ohm								
Part No. PE3C3233					Cable Dia.	Attn. @ 1 GHz	Power @ 1 GHz	
1 piece price shown. See web or call for volume pricing.					0.300" dia.	6 dB/100ft	W	
12"	24"	36"	48"	60"	50CM	Custom Len.		
\$338.49	\$364.42	\$390.36	\$416.30	\$442.23	\$355.10	See Web		
Standard Formable Cable Assemblies								
PE-SR401FL Coax, 50 Ohm								
Part No. PE34680					Cable Dia.	Attn. @ 1 GHz	Power @ 1 GHz	
1 piece price shown. See web or call for volume pricing.					* dia.	8 dB/100ft	1400 W	
12"	24"	36"	48"	60"	Custom Len.			
\$115.08	\$123.95	\$139.36	\$154.76	\$170.17	-	See Web		
PE-SR402FL Coax, 50 Ohm								
Part No. PE39452					Cable Dia.	Attn. @ 1 GHz	Power @ 1 GHz	
1 piece price shown. See web or call for volume pricing.					* dia.	12 dB/100ft	400 W	
6"	9"	12"	18"	24"	Custom Len.			
\$76.73	\$78.69	\$80.65	\$78.23	\$82.00	-	See Web		
PE-SR3977 Coax, 50 Ohm								
Part No. PE33977					Cable Dia.	Attn. @ 1 GHz	Power @ 1 GHz	
1 piece price shown. See web or call for volume pricing.					* dia.	12 dB/100ft	450 W	
12"	24"	36"	48"	60"	Custom Len.			
\$76.29	\$83.85	\$91.38	\$98.91	\$106.46	-	See Web		
PE-SR402FLJ Coax, 50 Ohm								
Part No. PE39466					Cable Dia.	Attn. @ 1 GHz	Power @ 1 GHz	
1 piece price shown. See web or call for volume pricing.					0.161" dia.	12 dB/100ft	303 W	
6"	9"	12"	18"	24"	Custom Len.			
\$76.80	\$76.80	\$76.80	\$80.58	\$84.36	-	See Web		
Standard Flexible Cable Assemblies								
RG8A/U Coax, 50 Ohm								
Part No. PE33974					Cable Dia.	Attn. @ 1 GHz	Power @ 1 GHz	
1 piece price shown. See web or call for volume pricing.					0.405" dia.	8 dB/100ft	190 W	
12"	24"	36"	48"	60"	72"	Custom Len.		
\$108.29	\$111.36	\$114.44	\$112.63	\$115.45	\$123.95	See Web		
RG58C/U Coax, 50 Ohm								
Part No. PE3698					Cable Dia.	Attn. @ 1 GHz	Power @ 1 GHz	
1 piece price shown. See web or call for volume pricing.					0.195" dia.	20 dB/100ft	44 W	
12"	24"	36"	48"	60"	72"	Custom Len.		
\$78.92	\$75.19	\$80.55	\$76.67	\$77.41	\$83.07	See Web		

Cable Assemblies
See Our Website For Current Pricing & Real-Time Stock Availability!

*Coax Performance at 1 GHz Notes: Cable assembly max frequency may be lower than connector or coax max frequency

For our complete selection of cable assemblies, please visit our website

RG174A/U Coax, 50 Ohm						
Part No. PE34231	Cable Dia.	Attn. @ 1 GHz	Power @ 1 GHz			
1 piece price shown. See web or call for volume pricing.						
12"	24"	36"	48"	60"	72"	Custom Len.
\$70.65	\$71.14	\$71.57	\$72.03	\$72.47	\$72.88	See Web
RG188A/U Coax, 50 Ohm						
Part No. PE34238	Cable Dia.	Attn. @ 1 GHz	Power @ 1 GHz			
1 piece price shown. See web or call for volume pricing.						
12"	24"	36"	48"	60"	72"	Custom Len.
\$84.44	\$78.98	\$89.43	\$83.42	\$85.64	\$87.86	See Web
RG213/U Coax, 50 Ohm						
Part No. PE3272	Cable Dia.	Attn. @ 1 GHz	Power @ 1 GHz			
1 piece price shown. See web or call for volume pricing.						
12"	24"	36"	48"	60"	72"	Custom Len.
\$107.11	\$102.71	\$104.37	\$112.58	\$107.69	\$109.35	See Web
RG214/U Coax, 50 Ohm						
Part No. PE3781	Cable Dia.	Attn. @ 1 GHz	Power @ 1 GHz			
1 piece price shown. See web or call for volume pricing.						
12"	24"	36"	48"	60"	72"	Custom Len.
\$120.95	\$135.98	\$135.60	\$142.92	\$159.93	\$167.86	See Web
RG223/U Coax, 50 Ohm						
Part No. PE3882	Cable Dia.	Attn. @ 1 GHz	Power @ 1 GHz			
1 piece price shown. See web or call for volume pricing.						
12"	24"	36"	48"	60"	72"	Custom Len.
\$83.85	\$80.52	\$83.42	\$86.32	\$89.23	\$92.13	See Web
RG225/U Coax, 50 Ohm						
Part No. PE34222	Cable Dia.	Attn. @ 1 GHz	Power @ 1 GHz			
1 piece price shown. See web or call for volume pricing.						
12"	24"	36"	48"	60"	72"	Custom Len.
\$142.62	\$175.21	\$207.80	\$265.84	\$272.97	\$305.56	See Web
RG316/U Coax, 50 Ohm						
Part No. PE34236	Cable Dia.	Attn. @ 1 GHz	Power @ 1 GHz			
1 piece price shown. See web or call for volume pricing.						
12"	24"	36"	48"	60"	72"	Custom Len.
\$77.63	\$80.52	\$83.41	\$86.30	\$89.18	\$98.22	See Web
RG393/U Coax, 50 Ohm						
Part No. PE3268	Cable Dia.	Attn. @ 1 GHz	Power @ 1 GHz			
1 piece price shown. See web or call for volume pricing.						
12"	24"	36"	48"	60"	72"	Custom Len.
\$115.81	\$139.16	\$155.57	\$172.93	\$189.65	\$206.38	See Web
RG400/U Coax, 50 Ohm						
Part No. PE3412	Cable Dia.	Attn. @ 1 GHz	Power @ 1 GHz			
1 piece price shown. See web or call for volume pricing.						
12"	24"	36"	48"	60"	72"	Custom Len.
\$92.16	\$99.56	\$106.95	\$114.78	\$114.82	\$129.85	See Web
PE-P141EAM Coax, 50 Ohm						
Part No. PE3CA1049	Cable Dia.	Attn. @ 1 GHz	Power @ 1 GHz			
1 piece price shown. See web or call for volume pricing.						
12"	24"	36"	50CM	100CM	-	Custom Len.
\$103.16	\$119.49	\$135.80	\$113.61	\$140.38	-	See Web
N MALE RIGHT ANGLE TO N FEMALE						
						
Low Loss Test Flexible Cable Assemblies						
PE-P300LL Coax, 50 Ohm						
Part No. PE3C3115	Cable Dia.	Attn. @ 1 GHz	Power @ 1 GHz			
1 piece price shown. See web or call for volume pricing.						
12"	24"	36"	48"	60"	50CM	Custom Len.
\$326.66	\$352.60	\$378.54	\$404.47	\$430.41	\$343.28	See Web
Standard Flexible Cable Assemblies						
RG400/U Coax, 50 Ohm						
Part No. PE3W06096	Cable Dia.	Attn. @ 1 GHz	Power @ 1 GHz			
1 piece price shown. See web or call for volume pricing.						
12"	24"	36"	48"	60"	50CM	Custom Len.
\$70.10	\$77.71	\$85.32	\$92.94	\$100.55	\$74.97	See Web
N MALE RIGHT ANGLE TO N FEMALE BULKHEAD						
SEE MOUNTING HOLE SECTION ON PAGE 369						
						
Flexible Cable Assemblies						
LMR-400 Coax, 50 Ohm						
Part No. PE3W03991	Cable Dia.	Attn. @ 1 GHz	Power @ 1 GHz			
1 piece price shown. See web or call for volume pricing.						
12"	24"	36"	48"	60"	50CM	Custom Len.
\$73.26	\$74.51	\$75.75	\$77.00	\$78.25	\$74.06	See Web
Low Loss Flexible Cable Assemblies						
PE-P142LL Coax, 50 Ohm						
Part No. PE3C0673	Cable Dia.	Attn. @ 1 GHz	Power @ 1 GHz			
1 piece price shown. See web or call for volume pricing.						
12"	24"	36"	48"	60"	50CM	Custom Len.
\$263.75	\$279.51	\$295.26	\$311.02	\$326.78	\$273.85	See Web
PE-P160LL Coax, 50 Ohm						
Part No. PE3C5281	Cable Dia.	Attn. @ 1 GHz	Power @ 1 GHz			
1 piece price shown. See web or call for volume pricing.						
12"	24"	36"	48"	60"	50CM	Custom Len.
\$301.32	\$322.04	\$342.75	\$363.45	\$384.17	\$314.59	See Web

Part No. PE3C5286						
Cable Dia.	Attn. @ 1 GHz	Power @ 1 GHz				
1 piece price shown. See web or call for volume pricing.						
12"	24"	36"	48"	60"	50CM	Custom Len.
\$290.49	\$311.21	\$331.92	\$352.63	\$373.34	\$303.76	See Web
LMR-240-UF Coax, 50 Ohm						
Part No. PE3W06441	Cable Dia.	Attn. @ 1 GHz	Power @ 1 GHz			
1 piece price shown. See web or call for volume pricing.						
12"	24"	36"	48"	60"	50CM	Custom Len.
\$78.08	\$79.42	\$80.77	\$82.12	\$83.47	\$78.94	See Web
Low Loss Test Flexible Cable Assemblies						
PE-P300LL Coax, 50 Ohm						
Part No. PE3C2953	Cable Dia.	Attn. @ 1 GHz	Power @ 1 GHz			
1 piece price shown. See web or call for volume pricing.						
12"	24"	36"	48"	60"	50CM	Custom Len.
\$350.26	\$375.44	\$400.63	\$425.80	\$451.27	\$366.40	See Web
Standard Formable Cable Assemblies						
PE-SR402FL Coax, 50 Ohm						
Part No. PE38670	Cable Dia.	Attn. @ 1 GHz	Power @ 1 GHz			
1 piece price shown. See web or call for volume pricing.						
12"	24"	36"	48"	60"	-	Custom Len.
\$85.52	\$87.88	\$95.03	\$102.18	\$109.31	-	See Web
Standard Flexible Cable Assemblies						
RG58C/U Coax, 50 Ohm						
Part No. PE3407	Cable Dia.	Attn. @ 1 GHz	Power @ 1 GHz			
1 piece price shown. See web or call for volume pricing.						
12"	24"	36"	48"	60"	72"	Custom Len.
\$71.22	\$72.03	\$67.42	\$68.16	\$68.90	\$69.63	See Web
RG142B/U Coax, 50 Ohm						
Part No. PE33021	Cable Dia.	Attn. @ 1 GHz	Power @ 1 GHz			
1 piece price shown. See web or call for volume pricing.						
12"	24"	36"	48"	60"	72"	Custom Len.
\$72.85	\$74.45	\$80.20	\$85.93	\$97.65	\$97.39	See Web
RG213/U Coax, 50 Ohm						
Part No. PE33545	Cable Dia.	Attn. @ 1 GHz	Power @ 1 GHz			
1 piece price shown. See web or call for volume pricing.						
12"	24"	36"	48"	60"	72"	Custom Len.
\$94.51	\$96.17	\$97.82	\$99.48	\$101.15	\$102.81	See Web
RG214/U Coax, 50 Ohm						
Part No. PE33178	Cable Dia.	Attn. @ 1 GHz	Power @ 1 GHz			
1 piece price shown. See web or call for volume pricing.						
12"	24"	36"	48"	60"	72"	Custom Len.
\$87.88	\$95.27	\$102.65	\$110.03	\$117.42	\$124.79	See Web
RG223/U Coax, 50 Ohm						
Part No. PE33536	Cable Dia.	Attn. @ 1 GHz	Power @ 1 GHz			
1 piece price shown. See web or call for volume pricing.						
12"	24"	36"	48"	60"	72"	Custom Len.
\$62.20	\$69.05	\$68.01	\$70.95	\$73.84	\$81.81	See Web
RG225/U Coax, 50 Ohm						
Part No. PE34221	Cable Dia.	Attn. @ 1 GHz	Power @ 1 GHz			
1 piece price shown. See web or call for volume pricing.						
12"	24"	36"	48"	60"	72"	Custom Len.
\$113.10	\$145.69	\$178.27	\$210.85	\$243.44	\$276.02	See Web
RG393/U Coax, 50 Ohm						
Part No. PE33532	Cable Dia.	Attn. @ 1 GHz	Power @ 1 GHz			
1 piece price shown. See web or call for volume pricing.						
12"	24"	36"	48"	60"	72"	Custom Len.
\$93.17	\$108.63	\$124.10	\$139.56	\$155.03	\$170.50	See Web
RG400/U Coax, 50 Ohm						
Part No. PE33528	Cable Dia.	Attn. @ 1 GHz	Power @ 1 GHz			
1 piece price shown. See web or call for volume pricing.						
12"	24"	36"	48"	60"	72"	Custom Len.
\$76.63	\$83.60	\$94.48	\$102.31	\$104.50	\$111.47	See Web
N MALE RIGHT ANGLE TO SMA MALE						
						
Low Loss Flexible Cable Assemblies						
PE-P160LL Coax, 50 Ohm						
Part No. PE3C5279	Cable Dia.	Attn. @ 1 GHz	Power @ 1 GHz			
1 piece price shown. See web or call for volume pricing.						
12"	24"	36"	48"	60"	50CM	Custom Len.
\$264.21	\$284.92	\$305.63	\$326.35	\$347.06	\$277.48	See Web
N MALE RIGHT ANGLE TO SMA MALE RIGHT ANGLE						
						
Low Loss Flexible Cable Assemblies						
PE-P160LL Coax, 50 Ohm						
Part No. PE3C5281	Cable Dia.	Attn. @ 1 GHz	Power @ 1 GHz			
1 piece price shown. See web or call for volume pricing.						
12"	24"	36"	48"	60"	50CM	Custom Len.
\$301.32	\$322.04	\$342.75	\$363.45	\$384.17	\$314.59	See Web

Cable Assemblies

See Our Website For Current Pricing & Real-Time Stock Availability!

For Custom Lengths, Metric Lengths or Special Configurations, Please call (949) 261-1920

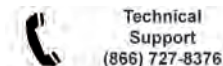

Technical Support
(866) 727-8376



Same-Day Shipping,
Even Custom
Cable Assemblies

For our complete selection of cable assemblies, please visit our website

N MALE RIGHT ANGLE TO SMA FEMALE BULKHEAD SEE MOUNTING HOLE SECTION ON PAGE 369						
---	--	--	--	--	--	--



Low Loss Flexible Cable Assemblies						
PE-P160LL Coax, 50 Ohm						
Part No. PE3C5280	Cable Dia.			Attn. @ 1 GHz	Power @ 1 GHz	
1 piece price shown. See web or call for volume pricing.	0.160" dia.			dB/100ft	W	
12"	24"	36"	48"	60"	50CM	Custom Len.
\$281.22	\$301.93	\$322.64	\$343.35	\$364.07	\$294.48	See Web

36

N MALE RIGHT ANGLE TO TNC MALE						
---------------------------------------	--	--	--	--	--	--



Flexible Cable Assemblies						
LMR-600-DB Coax, 50 Ohm						
Part No. PE3C4750	Cable Dia.			Attn. @ 1 GHz	Power @ 1 GHz	
1 piece price shown. See web or call for volume pricing.	0.590" dia.			3 dB/100ft	W	
12"	24"	36"	48"	60"	50CM	Custom Len.
\$80.21	\$83.17	\$86.13	\$89.09	\$92.06	\$82.11	See Web

37

Low Loss Flexible Cable Assemblies						
PE-P160LL Coax, 50 Ohm						
Part No. PE3C5282	Cable Dia.			Attn. @ 1 GHz	Power @ 1 GHz	
1 piece price shown. See web or call for volume pricing.	0.160" dia.			dB/100ft	W	
12"	24"	36"	48"	60"	50CM	Custom Len.
\$264.21	\$284.92	\$305.63	\$326.35	\$347.06	\$277.48	See Web

38

Low Loss Test Flexible Cable Assemblies						
PE-P300LL Coax, 50 Ohm						
Part No. PE3C3243	Cable Dia.			Attn. @ 1 GHz	Power @ 1 GHz	
1 piece price shown. See web or call for volume pricing.	0.300" dia.			6 dB/100ft	W	
12"	24"	36"	48"	60"	50CM	Custom Len.
\$378.20	\$403.39	\$428.60	\$453.80	\$479.01	\$394.33	See Web

39

N MALE RIGHT ANGLE TO TNC MALE RIGHT ANGLE						
---	--	--	--	--	--	--



Low Loss Flexible Cable Assemblies						
LMR-195 Coax, 50 Ohm						
Part No. PE3W00020	Cable Dia.			Attn. @ 1 GHz	Power @ 1 GHz	
1 piece price shown. See web or call for volume pricing.	0.195" dia.			12 dB/100ft	W	
12"	24"	36"	48"	60"	50CM	Custom Len.
\$57.96	\$58.68	\$59.41	\$60.14	\$60.86	\$58.42	See Web

40

Low Loss Flexible Cable Assemblies						
PE-P142LL Coax, 50 Ohm						
Part No. PE3C1271	Cable Dia.			Attn. @ 1 GHz	Power @ 1 GHz	
1 piece price shown. See web or call for volume pricing.	0.195" dia.			7 dB/100ft	W	
12"	24"	36"	48"	60"	50CM	Custom Len.
\$345.39	\$342.08	\$358.30	\$374.54	\$390.78	\$336.24	See Web

41

Low Loss Flexible Cable Assemblies						
PE-P160LL Coax, 50 Ohm						
Part No. PE3C5284	Cable Dia.			Attn. @ 1 GHz	Power @ 1 GHz	
1 piece price shown. See web or call for volume pricing.	0.160" dia.			dB/100ft	W	
12"	24"	36"	48"	60"	50CM	Custom Len.
\$322.97	\$343.69	\$364.40	\$385.11	\$405.82	\$336.24	See Web

42

N MALE RIGHT ANGLE TO TNC FEMALE BULKHEAD SEE MOUNTING HOLE SECTION ON PAGE 369						
---	--	--	--	--	--	--



Low Loss Flexible Cable Assemblies						
PE-P160LL Coax, 50 Ohm						
Part No. PE3C5283	Cable Dia.			Attn. @ 1 GHz	Power @ 1 GHz	
1 piece price shown. See web or call for volume pricing.	0.160" dia.			dB/100ft	W	
12"	24"	36"	48"	60"	50CM	Custom Len.
\$290.49	\$311.21	\$331.92	\$352.63	\$373.34	\$303.76	See Web

43

N MALE RIGHT ANGLE TO UHF MALE						
---------------------------------------	--	--	--	--	--	--



Standard Flexible Cable Assemblies						
RG214/U Coax, 50 Ohm						
Part No. PE38204	Cable Dia.			Attn. @ 1 GHz	Power @ 1 GHz	
1 piece price shown. See web or call for volume pricing.	0.425" dia.			7 dB/100ft	190 W	
12"	24"	36"	48"	60"	-	Custom Len.
\$97.21	\$104.98	\$112.76	\$121.00	\$121.01	-	See Web

44

N FEMALE TO N FEMALE						
Standard Flexible Cable Assemblies						
M17/60-RG142-27478 Coax, 50 Ohm						



Part No. PE3M0011	Cable Dia.			Attn. @ 1 GHz	Power @ 1 GHz	
1 piece price shown. See web or call for volume pricing.	0.195" dia.			dB/100ft	W	
12"	18"	24"	30"	36"	48"	Custom Len.
\$171.13	\$173.86	\$176.59	\$179.31	\$182.04	\$187.50	See Web

45

M17/84-RG223-0XDS2 Coax, 50 Ohm						
Part No. PE3M0039	Cable Dia.			Attn. @ 1 GHz	Power @ 1 GHz	
1 piece price shown. See web or call for volume pricing.	0.212" dia.			dB/100ft	W	
12"	18"	24"	30"	36"	48"	Custom Len.
\$175.44	\$180.31	\$185.19	\$190.06	\$194.95	\$204.70	See Web

46

M17/128-RG400-27478 Coax, 50 Ohm						
Part No. PE3M0067	Cable Dia.			Attn. @ 1 GHz	Power @ 1 GHz	
1 piece price shown. See web or call for volume pricing.	0.195" dia.			dB/100ft	W	
12"	18"	24"	30"	36"	48"	Custom Len.
\$172.62	\$176.09	\$179.56	\$183.03	\$186.50	\$193.44	See Web

47

N FEMALE TO N FEMALE BULKHEAD SEE MOUNTING HOLE SECTION ON PAGE 369						
---	--	--	--	--	--	--



Standard Flexible Cable Assemblies						
M17/60-RG142-27478 Coax, 50 Ohm						
Part No. PE3M0012	Cable Dia.			Attn. @ 1 GHz	Power @ 1 GHz	
1 piece price shown. See web or call for volume pricing.	0.195" dia.			dB/100ft	W	
12"	18"	24"	30"	36"	48"	Custom Len.
\$174.98	\$177.70	\$180.43	\$183.15	\$185.89	\$191.34	See Web

48

M17/84-RG223-0XDS2 Coax, 50 Ohm						
Part No. PE3M0040	Cable Dia.			Attn. @ 1 GHz	Power @ 1 GHz	
1 piece price shown. See web or call for volume pricing.	0.212" dia.			dB/100ft	W	
12"	18"	24"	30"	36"	48"	Custom Len.
\$179.28	\$184.15	\$189.04	\$193.91	\$198.79	\$208.55	See Web

49

M17/128-RG400-27478 Coax, 50 Ohm						
Part No. PE3M0068	Cable Dia.			Attn. @ 1 GHz	Power @ 1 GHz	
1 piece price shown. See web or call for volume pricing.	0.195" dia.			dB/100ft	W	
12"	18"	24"	30"	36"	48"	Custom Len.
\$176.46	\$179.93	\$183.40	\$186.87	\$190.34	\$197.29	See Web

50

N FEMALE TO SMA MALE						
-----------------------------	--	--	--	--	--	--



Standard Flexible Cable Assemblies						
M17/60-RG142-27478 Coax, 50 Ohm						
Part No. PE3M0017	Cable Dia.			Attn. @ 1 GHz	Power @ 1 GHz	
1 piece price shown. See web or call for volume pricing.	0.195" dia.			dB/100ft	W	
12"	18"	24"	30"	36"	48"	Custom Len.
\$194.87	\$197.60	\$200.33	\$203.05	\$205.78	\$211.24	See Web

51

M17/84-RG223-0XDS2 Coax, 50 Ohm						
Part No. PE3M0045	Cable Dia.			Attn. @ 1 GHz	Power @ 1 GHz	
1 piece price shown. See web or call for volume pricing.	0.212" dia.			dB/100ft	W	
12"	18"	24"	30"	36"	48"	Custom Len.
\$199.18	\$204.05	\$208.93	\$213.81	\$218.69	\$228.44	See Web

52

M17/128-RG400-27478 Coax, 50 Ohm						
Part No. PE3M0073	Cable Dia.			Attn. @ 1 GHz	Power @ 1 GHz	
1 piece price shown. See web or call for volume pricing.	0.195" dia.			dB/100ft	W	
12"	18"	24"	30"	36"	48"	Custom Len.
\$196.36	\$199.83	\$203.30	\$206.77	\$210.24	\$217.18	See Web

53

N FEMALE TO SMA MALE RIGHT ANGLE						
---	--	--	--	--	--	--



Standard Flexible Cable Assemblies						
M17/60-RG142-27478 Coax, 50 Ohm						
Part No. PE3M0018	Cable Dia.			Attn. @ 1 GHz	Power @ 1 GHz	
1 piece price shown. See web or call for volume pricing.	0.195" dia.			dB/100ft	W	
12"	18"	24"	30"	36"	48"	Custom Len.
\$230.96	\$233.68	\$236.41	\$239.14	\$241.87	\$247.32	See Web

54

M17/84-RG223-0XDS2 Coax, 50 Ohm						
Part No. PE3M0046	Cable Dia.			Attn. @ 1 GHz	Power @ 1 GHz	
1 piece price shown. See web or call for volume pricing.	0.212" dia.			dB/100ft	W	
12"	18"	24"	30"	36"	48"	Custom Len.
\$235.26	\$240.13	\$245.02	\$249.89	\$254.77	\$264.53	See Web

55

M17/128-RG400-27478 Coax, 50 Ohm						
Part No. PE3M0074	Cable Dia.			Attn. @ 1 GHz	Power @ 1 GHz	
1 piece price shown. See web or call for volume pricing.	0.195" dia.			dB/100ft	W	
12"	18"	24"	30"	36"	48"	Custom Len.
\$232.45	\$235.90	\$239.39	\$242.85	\$246.33	\$253.27	See Web

56

N FEMALE TO TNC MALE						
Standard Flexible Cable Assemblies						
M17/60-RG142-27478 Coax, 50 Ohm						



Cable Assemblies See Our Website For Current Pricing & Real-Time Stock Availability!

*Coax Performance at 1 GHz Notes: Cable assembly max frequency may be lower than connector or coax max frequency

For our complete selection of cable assemblies, please visit our website

Part No. PE3M0019	Cable Dia.	Attn. @ 1 GHz	Power @ 1 GHz
1 piece price shown. See web or call for volume pricing.			
12"	18"	24"	30"
\$164.16	\$166.88	\$169.62	\$172.34
36"	48"	60"	72"
\$175.07	\$180.53		

M17/84-RG223-0XDS2 Coax, 50 Ohm

Part No. PE3M0047	Cable Dia.	Attn. @ 1 GHz	Power @ 1 GHz
1 piece price shown. See web or call for volume pricing.			
12"	18"	24"	30"
\$168.46	\$173.34	\$178.22	\$183.09
36"	48"	60"	72"
\$187.98	\$197.73		

M17/128-RG400-27478 Coax, 50 Ohm

Part No. PE3M0075	Cable Dia.	Attn. @ 1 GHz	Power @ 1 GHz
1 piece price shown. See web or call for volume pricing.			
12"	18"	24"	30"
\$165.65	\$169.12	\$172.59	\$176.06
36"	48"	60"	72"
\$179.53	\$186.47		

N FEMALE TO 7/16 DIN MALE



Low PIM Corrugated Cable Assemblies

SPP-250-LLPL Coax, 50 Ohm

Part No. PE3C4133	Cable Dia.	Attn. @ 1 GHz	Power @ 1 GHz
1 piece price shown. See web or call for volume pricing.			
12"	24"	36"	48"
\$92.38	\$97.96	\$103.54	\$109.12
60"	72"		
\$114.70	\$95.95		

N FEMALE TO N FEMALE



Low Loss Flexible Cable Assemblies

LMR-600-DB Coax, 50 Ohm

Part No. PE3W05453	Cable Dia.	Attn. @ 1 GHz	Power @ 1 GHz
1 piece price shown. See web or call for volume pricing.			
12"	18"	24"	36"
\$70.64	\$71.93	\$73.23	\$75.82
48"	60"	72"	
\$78.41	\$81.00		

Low Loss Test Flexible Cable Assemblies

PE-P300LL Coax, 50 Ohm

Part No. PE3C3234	Cable Dia.	Attn. @ 1 GHz	Power @ 1 GHz
1 piece price shown. See web or call for volume pricing.			
12"	24"	36"	48"
\$269.26	\$294.44	\$319.62	\$344.80
60"	72"		
\$369.99	\$285.40		

Standard Corrugated Cable Assemblies

PE-1/4SFHC Coax, 50 Ohm

Part No. PE3C0126	Cable Dia.	Attn. @ 1 GHz	Power @ 1 GHz
1 piece price shown. See web or call for volume pricing.			
12"	24"	36"	48"
\$141.41	\$131.34	\$147.64	\$136.92
60"	72"		
\$139.70			

N FEMALE TO N FEMALE BULKHEAD

SEE MOUNTING HOLE SECTION ON PAGE 369



Standard Flexible Cable Assemblies

PE-P195 Coax, 50 Ohm

Part No. PE3W02976	Cable Dia.	Attn. @ 1 GHz	Power @ 1 GHz
1 piece price shown. See web or call for volume pricing.			
12"	24"	36"	48"
\$53.08	\$63.49	\$73.91	\$84.34
60"	72"		
\$94.76	\$59.75		

N FEMALE TO QN MALE RIGHT ANGLE



Low Loss Flexible Cable Assemblies

PE-C195 Coax, 50 Ohm

Part No. PE38494	Cable Dia.	Attn. @ 1 GHz	Power @ 1 GHz
1 piece price shown. See web or call for volume pricing.			
12"	24"	36"	48"
\$65.21	\$65.85	\$66.58	\$67.23
60"	72"		
\$67.96	\$75.71		

Standard Flexible Cable Assemblies

RG58C/U Coax, 50 Ohm

Part No. PE38493	Cable Dia.	Attn. @ 1 GHz	Power @ 1 GHz
1 piece price shown. See web or call for volume pricing.			
12"	24"	36"	48"
\$77.26	\$77.99	\$78.70	\$79.43
60"	72"		
\$80.21	\$80.92		

RG213/U Coax, 50 Ohm

Part No. PE38495	Cable Dia.	Attn. @ 1 GHz	Power @ 1 GHz
1 piece price shown. See web or call for volume pricing.			
12"	24"	36"	48"
\$90.15	\$91.85	\$93.52	\$95.21
60"	72"		
\$96.88	\$98.52		

N FEMALE TO SMA MALE RIGHT ANGLE



Low Loss Flexible Cable Assemblies

LMR-240-UF Coax, 50 Ohm

Part No. PE3W04423	Cable Dia.	Attn. @ 1 GHz	Power @ 1 GHz
1 piece price shown. See web or call for volume pricing.			
12"	24"	36"	48"
\$52.56	\$53.90	\$55.25	\$56.60
60"	72"		
\$57.96	\$53.43		

N FEMALE TO TNC MALE



Low Loss Test Flexible Cable Assemblies

PE-P300LL Coax, 50 Ohm

Part No. PE3C3244	Cable Dia.	Attn. @ 1 GHz	Power @ 1 GHz
1 piece price shown. See web or call for volume pricing.			
12"	24"	36"	48"
\$244.93	\$270.13	\$295.34	\$320.54
60"	72"		
\$345.75	\$261.07		

N FEMALE BULKHEAD TO N FEMALE BULKHEAD

SEE MOUNTING HOLE SECTION ON PAGE 369



Standard Flexible Cable Assemblies

M17/60-RG142-27478 Coax, 50 Ohm

Part No. PE3M0013	Cable Dia.	Attn. @ 1 GHz	Power @ 1 GHz
1 piece price shown. See web or call for volume pricing.			
12"	18"	24"	30"
\$178.82	\$181.54	\$184.28	\$187.00
36"	48"		
\$189.73	\$195.19		

M17/84-RG223-0XDS2 Coax, 50 Ohm

Part No. PE3M0041	Cable Dia.	Attn. @ 1 GHz	Power @ 1 GHz
1 piece price shown. See web or call for volume pricing.			
12"	18"	24"	30"
\$183.12	\$188.00	\$192.88	\$197.75
36"	48"		
\$202.64	\$212.39		

M17/128-RG400-27478 Coax, 50 Ohm

Part No. PE3M0069	Cable Dia.	Attn. @ 1 GHz	Power @ 1 GHz
1 piece price shown. See web or call for volume pricing.			
12"	18"	24"	30"
\$180.31	\$183.78	\$187.25	\$190.72
36"	48"		
\$194.19	\$201.13		

N FEMALE BULKHEAD TO SMA MALE

SEE MOUNTING HOLE SECTION ON PAGE 369



Standard Flexible Cable Assemblies

M17/60-RG142-27478 Coax, 50 Ohm

Part No. PE3M0020	Cable Dia.	Attn. @ 1 GHz	Power @ 1 GHz
1 piece price shown. See web or call for volume pricing.			
12"	18"	24"	30"
\$198.72	\$201.44	\$204.17	\$206.90
36"	48"		
\$209.63	\$215.08		

M17/84-RG223-0XDS2 Coax, 50 Ohm

Part No. PE3M0048	Cable Dia.	Attn. @ 1 GHz	Power @ 1 GHz
1 piece price shown. See web or call for volume pricing.			
12"	18"	24"	30"
\$203.02	\$207.89	\$212.78	\$217.65
36"	48"		
\$222.53	\$232.29		

M17/128-RG400-27478 Coax, 50 Ohm

Part No. PE3M0076	Cable Dia.	Attn. @ 1 GHz	Power @ 1 GHz
1 piece price shown. See web or call for volume pricing.			
12"	18"	24"	30"
\$200.20	\$203.68	\$207.15	\$210.62
36"	48"		
\$214.09	\$221.03		

N FEMALE BULKHEAD TO SMA MALE RIGHT ANGLE

SEE MOUNTING HOLE SECTION ON PAGE 369



Standard Flexible Cable Assemblies

M17/60-RG142-27478 Coax, 50 Ohm

Part No. PE3M0021	Cable Dia.	Attn. @ 1 GHz	Power @ 1 GHz
1 piece price shown. See web or call for volume pricing.			
12"	18"	24"	30"
\$234.80	\$237.53	\$240.26	\$242.98
36"	48"		
\$245.71	\$251.17		

M17/84-RG223-0XDS2 Coax, 50 Ohm

Part No. PE3M0049	Cable Dia.	Attn. @ 1 GHz	Power @ 1 GHz
1 piece price shown. See web or call for volume pricing.			
12"	18"	24"	30"
\$239.11	\$243.98	\$248.86	\$253.73
36"	48"		
\$258.62	\$268.37		

M17/128-RG400-27478 Coax, 50 Ohm

Part No. PE3M0077	Cable Dia.	Attn. @ 1 GHz	Power @ 1 GHz
1 piece price shown. See web or call for volume pricing.			
12"	18"	24"	30"
\$236.29	\$239.75	\$243.23	\$246.69
36"	48"		
\$250.17	\$257.11		

N FEMALE BULKHEAD TO TNC MALE

SEE MOUNTING HOLE SECTION ON PAGE 369



Standard Flexible Cable Assemblies

Cable Assemblies

See Our Website For Current Pricing & Real-Time Stock Availability!

Continued on Next Page

For Custom Lengths, Metric Lengths or Special Configurations, Please call (949) 261-1920

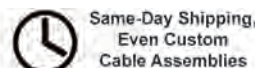
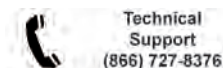

For our complete selection of cable assemblies, please visit our website

Cable Assemblies







See Our Website For Current Pricing & Real-Time Stock Availability!

M17/60-RG142-27478 Coax, 50 Ohm				
Part No. PE3M0022	Cable Dia.	Attn. @ 1 GHz	Power @ 1 GHz	
1 piece price shown. See web or call for volume pricing.				
12"	18"	24"	30"	36"
\$168.01	\$170.73	\$173.46	\$176.18	\$178.92
				48"
				60"
				Custom Len.
				See Web
M17/84-RG223-0XDS2 Coax, 50 Ohm				
Part No. PE3M0050	Cable Dia.	Attn. @ 1 GHz	Power @ 1 GHz	
1 piece price shown. See web or call for volume pricing.				
12"	18"	24"	30"	36"
\$172.31	\$177.18	\$182.06	\$186.94	\$191.82
				48"
				60"
				Custom Len.
				See Web
M17/128-RG400-27478 Coax, 50 Ohm				
Part No. PE3M0078	Cable Dia.	Attn. @ 1 GHz	Power @ 1 GHz	
1 piece price shown. See web or call for volume pricing.				
12"	18"	24"	30"	36"
\$169.49	\$172.96	\$176.43	\$179.90	\$183.37
				48"
				60"
				Custom Len.
				See Web
N FEMALE BULKHEAD TO BNC MALE				
SEE MOUNTING HOLE SECTION ON PAGE 369				
Low Loss Flexible Cable Assemblies				
LMR-200 Coax, 50 Ohm				
Part No. PE3W07094	Cable Dia.	Attn. @ 1 GHz	Power @ 1 GHz	
1 piece price shown. See web or call for volume pricing.				
12"	18"	24"	36"	48"
\$45.85	\$46.19	\$46.54	\$47.23	\$47.92
				60"
				Custom Len.
				See Web
N FEMALE BULKHEAD TO MCX PLUG RIGHT ANGLE				
SEE MOUNTING HOLE SECTION ON PAGE 369				
Precision Formable Cable Assemblies				
PE-SR405FL Coax, 50 Ohm				
Part No. PE39449	Cable Dia.	Attn. @ 1 GHz	Power @ 1 GHz	
1 piece price shown. See web or call for volume pricing.				
6"	9"	12"	18"	24"
\$51.08	\$52.40	\$52.40	\$62.26	\$63.09
				-
				Custom Len.
				See Web
PE-SR405FLJ Coax, 50 Ohm				
Part No. PE39463	Cable Dia.	Attn. @ 1 GHz	Power @ 1 GHz	
1 piece price shown. See web or call for volume pricing.				
6"	9"	12"	18"	24"
\$49.26	\$49.26	\$49.26	\$53.13	\$57.01
				-
				Custom Len.
				See Web
N FEMALE BULKHEAD TO MMCX PLUG RIGHT ANGLE				
SEE MOUNTING HOLE SECTION ON PAGE 369				
Precision Formable Cable Assemblies				
PE-SR405FL Coax, 50 Ohm				
Part No. PE39450	Cable Dia.	Attn. @ 1 GHz	Power @ 1 GHz	
1 piece price shown. See web or call for volume pricing.				
6"	9"	12"	18"	24"
\$51.94	\$51.94	\$56.10	\$57.29	\$62.63
				-
				Custom Len.
				See Web
PE-SR405FLJ Coax, 50 Ohm				
Part No. PE39464	Cable Dia.	Attn. @ 1 GHz	Power @ 1 GHz	
1 piece price shown. See web or call for volume pricing.				
6"	9"	12"	18"	24"
\$49.65	\$51.72	\$49.81	\$53.69	\$57.56
				-
				Custom Len.
				See Web
N FEMALE BULKHEAD TO N MALE				
SEE MOUNTING HOLE SECTION ON PAGE 369				
Standard Flexible Cable Assemblies				
PE-P141EAM Coax, 50 Ohm				
Part No. PE3CA1050	Cable Dia.	Attn. @ 1 GHz	Power @ 1 GHz	
1 piece price shown. See web or call for volume pricing.				
12"	24"	36"	50CM	100CM
\$92.34	\$109.82	\$127.30	\$103.54	\$132.19
				-
				Custom Len.
				See Web
N FEMALE BULKHEAD TO N MALE RIGHT ANGLE				
SEE MOUNTING HOLE SECTION ON PAGE 369				
Low Loss Flexible Cable Assemblies				
PE-P142LL-27478 Coax, 50 Ohm				
Part No. PE3M0178	Cable Dia.	Attn. @ 1 GHz	Power @ 1 GHz	
1 piece price shown. See web or call for volume pricing.				
12"	18"	24"	36"	48"
\$572.29	\$580.77	\$589.25	\$606.20	\$623.16
				\$640.12
				Custom Len.
				See Web
PE-P160LL-27478 Coax, 50 Ohm				
Part No. PE3M0223	Cable Dia.	Attn. @ 1 GHz	Power @ 1 GHz	
1 piece price shown. See web or call for volume pricing.				
8"	12"	18"	24"	30"
\$540.67	\$545.58	\$552.92	\$560.28	\$567.63
				\$574.98
				Custom Len.
				See Web
PE-P300LL-27478 Coax, 50 Ohm				

Part No. PE3M0251					Cable Dia.	Attn. @ 1 GHz	Power @ 1 GHz	
1 piece price shown. See web or call for volume pricing.					0.300" dia.	dB/100ft	W	
12"	18"	24"	36"	48"	60"	60"	Custom Len.	
\$638.67	\$652.82	\$666.98	\$695.28	\$723.58	\$751.88		See Web	
Standard Formable Cable Assemblies								
PE-SR402FLJ Coax, 50 Ohm								
Part No. PE3W03365					Cable Dia.	Attn. @ 1 GHz	Power @ 1 GHz	
1 piece price shown. See web or call for volume pricing.					0.161" dia.	12 dB/100ft	303 W	
12"	24"	36"	48"	60"	50CM	50CM	Custom Len.	
\$75.30	\$84.18	\$93.06	\$101.95	\$110.83	\$80.98		See Web	
N FEMALE BULKHEAD TO N FEMALE BULKHEAD								
SEE MOUNTING HOLE SECTION ON PAGE 369								
Low Loss Flexible Cable Assemblies								
PE-P142LL-27478 Coax, 50 Ohm								
Part No. PE3M0177					Cable Dia.	Attn. @ 1 GHz	Power @ 1 GHz	
1 piece price shown. See web or call for volume pricing.					0.195" dia.	dB/100ft	W	
12"	18"	24"	36"	48"	60"	60"	Custom Len.	
\$544.46	\$552.94	\$561.41	\$578.37	\$595.33	\$612.28		See Web	
PE-P160LL-27478 Coax, 50 Ohm								
Part No. PE3M0222					Cable Dia.	Attn. @ 1 GHz	Power @ 1 GHz	
1 piece price shown. See web or call for volume pricing.					0.160" dia.	dB/100ft	W	
8"	12"	18"	24"	30"	36"	36"	Custom Len.	
\$544.61	\$549.52	\$556.86	\$564.22	\$571.56	\$578.92		See Web	
PE-P300LL-27478 Coax, 50 Ohm								
Part No. PE3M0250					Cable Dia.	Attn. @ 1 GHz	Power @ 1 GHz	
1 piece price shown. See web or call for volume pricing.					0.300" dia.	dB/100ft	W	
12"	18"	24"	36"	48"	60"	60"	Custom Len.	
\$569.41	\$583.56	\$597.72	\$626.02	\$654.32	\$682.62		See Web	
PE-P160LL Coax, 50 Ohm								
Part No. PE3C5256					Cable Dia.	Attn. @ 1 GHz	Power @ 1 GHz	
1 piece price shown. See web or call for volume pricing.					0.160" dia.	dB/100ft	W	
12"	24"	36"	48"	60"	50CM	50CM	Custom Len.	
\$258.01	\$278.73	\$299.44	\$320.15	\$340.86	\$271.28		See Web	
N FEMALE BULKHEAD TO QMA MALE RIGHT ANGLE								
SEE MOUNTING HOLE SECTION ON PAGE 369								
Standard Flexible Cable Assemblies								
RG316/U Coax, 50 Ohm								
Part No. PE3C4238					Cable Dia.	Attn. @ 1 GHz	Power @ 1 GHz	
1 piece price shown. See web or call for volume pricing.					0.098" dia.	58 dB/100ft	160 W	
12"	24"	36"	48"	60"	50CM	50CM	Custom Len.	
\$65.08	\$68.12	\$71.15	\$74.18	\$77.22	\$67.03		See Web	
N FEMALE BULKHEAD TO SMA MALE								
SEE MOUNTING HOLE SECTION ON PAGE 369								
Low Loss Flexible Cable Assemblies								
PE-P160LL Coax, 50 Ohm								
Part No. PE3C5274					Cable Dia.	Attn. @ 1 GHz	Power @ 1 GHz	
1 piece price shown. See web or call for volume pricing.					0.160" dia.	dB/100ft	W	
12"	24"	36"	48"	60"	50CM	50CM	Custom Len.	
\$231.73	\$252.45	\$273.15	\$293.87	\$314.58	\$245.00		See Web	
N FEMALE BULKHEAD TO SMA MALE RIGHT ANGLE								
SEE MOUNTING HOLE SECTION ON PAGE 369								
Flexible Cable Assemblies								
PE-P195 Coax, 50 Ohm								
Part No. PE3W06405					Cable Dia.	Attn. @ 1 GHz	Power @ 1 GHz	
1 piece price shown. See web or call for volume pricing.					0.195" dia.	13 dB/100ft	650 W	
12"	24"	36"	48"	60"	50CM	50CM	Custom Len.	
\$51.27	\$61.69	\$72.11	\$82.53	\$92.95	\$57.95		See Web	
Low Loss Flexible Cable Assemblies								
PE-P160LL Coax, 50 Ohm								
Part No. PE3C5276					Cable Dia.	Attn. @ 1 GHz	Power @ 1 GHz	
1 piece price shown. See web or call for volume pricing.					0.160" dia.	dB/100ft	W	
12"	24"	36"	48"	60"	50CM	50CM	Custom Len.	
\$268.84	\$289.56	\$310.27	\$330.97	\$351.69	\$282.11		See Web	
N FEMALE BULKHEAD TO SMA FEMALE								
SEE MOUNTING HOLE SECTION ON PAGE 369								
Flexible Cable Assemblies								
LMR-400-UF Coax, 50 Ohm								
Part No. PE3W05630					Cable Dia.	Attn. @ 1 GHz	Power @ 1 GHz	
1 piece price shown. See web or call for volume pricing.					0.405" dia.	5 dB/100ft	W	
12"	24"	36"	48"	60"	50CM	50CM	Custom Len.	
\$85.21	\$87.83	\$90.46	\$93.08	\$95.71	\$86.89		See Web	

*Coax Performance at 1 GHz Notes: Cable assembly max frequency may be lower than connector or coax max frequency

For our complete selection of cable assemblies, please visit our website

N FEMALE BULKHEAD TO SMA FEMALE BULKHEAD SEE MOUNTING HOLE SECTION ON PAGE 369								
Standard Flexible Cable Assemblies								
PE-P160LL Coax, 50 Ohm								
Part No. PE3C5278		Cable Dia.		Attn. @ 1 GHz		Power @ 1 GHz		
1 piece price shown. See web or call for volume pricing.								
12"	24"	36"	48"	0.160" dia.	dB/100ft	W		
\$248.74	\$248.74	\$248.74	\$248.74	60"	50CM	Custom Len.		
See Web								
N FEMALE BULKHEAD TO REVERSE POLARITY SMA MALE RIGHT ANGLE SEE MOUNTING HOLE SECTION ON PAGE 369								
Standard Flexible Cable Assemblies								
RG400/U Coax, 50 Ohm								
Part No. PE3C5030		Cable Dia.		Attn. @ 1 GHz		Power @ 1 GHz		
1 piece price shown. See web or call for volume pricing.								
12"	24"	36"	48"	0.195" dia.	15 dB/100ft	600 W		
\$78.89	\$86.07	\$93.25	\$100.43	60"	50CM	Custom Len.		
See Web								
N FEMALE BULKHEAD TO SMP FEMALE RIGHT ANGLE SEE MOUNTING HOLE SECTION ON PAGE 369								
Standard Flexible Cable Assemblies								
RG178B/U Coax, 50 Ohm								
Part No. PE3W04763		Cable Dia.		Attn. @ 1 GHz		Power @ 1 GHz		
1 piece price shown. See web or call for volume pricing.								
12"	24"	36"	48"	0.072" dia.	44 dB/100ft	55 W		
\$73.41	\$74.43	\$75.46	\$76.49	60"	50CM	Custom Len.		
See Web								
N FEMALE BULKHEAD TO TNC MALE SEE MOUNTING HOLE SECTION ON PAGE 369								
Low Loss Flexible Cable Assemblies								
PE-P142LL Coax, 50 Ohm								
Part No. PE3C1110		Cable Dia.		Attn. @ 1 GHz		Power @ 1 GHz		
1 piece price shown. See web or call for volume pricing.								
12"	24"	36"	48"	0.195" dia.	10 dB/100ft	W		
\$187.67	\$203.44	\$220.30	\$234.95	60"	50CM	Custom Len.		
See Web								
PE-P160LL Coax, 50 Ohm								
Part No. PE3C5270		Cable Dia.		Attn. @ 1 GHz		Power @ 1 GHz		
1 piece price shown. See web or call for volume pricing.								
12"	24"	36"	48"	0.160" dia.	dB/100ft	W		
\$231.73	\$252.45	\$273.15	\$293.87	60"	50CM	Custom Len.		
See Web								
Low Loss Test Flexible Cable Assemblies								
PE-P300LL Coax, 50 Ohm								
Part No. PE3C1084		Cable Dia.		Attn. @ 1 GHz		Power @ 1 GHz		
1 piece price shown. See web or call for volume pricing.								
12"	24"	36"	48"	0.300" dia.	6 dB/100ft	W		
\$253.67	\$278.85	\$304.03	\$329.22	60"	50CM	Custom Len.		
See Web								
N FEMALE BULKHEAD TO TNC MALE RIGHT ANGLE SEE MOUNTING HOLE SECTION ON PAGE 369								
Low Loss Flexible Cable Assemblies								
LMR-240 Coax, 50 Ohm								
Part No. PE3W00415		Cable Dia.		Attn. @ 1 GHz		Power @ 1 GHz		
1 piece price shown. See web or call for volume pricing.								
12"	24"	36"	48"	0.240" dia.	8 dB/100ft	W		
\$53.67	\$54.61	\$55.56	\$56.50	60"	50CM	Custom Len.		
See Web								
PE-P160LL Coax, 50 Ohm								
Part No. PE3C5271		Cable Dia.		Attn. @ 1 GHz		Power @ 1 GHz		
1 piece price shown. See web or call for volume pricing.								
12"	24"	36"	48"	0.160" dia.	dB/100ft	W		
\$290.49	\$311.21	\$331.92	\$352.63	60"	50CM	Custom Len.		
See Web								
N FEMALE BULKHEAD TO TNC FEMALE BULKHEAD SEE MOUNTING HOLE SECTION ON PAGE 369								
Low Loss Flexible Cable Assemblies								
PE-P160LL Coax, 50 Ohm								
Part No. PE3C5272		Cable Dia.		Attn. @ 1 GHz		Power @ 1 GHz		
1 piece price shown. See web or call for volume pricing.								
12"	24"	36"	48"	0.160" dia.	dB/100ft	W		
\$258.01	\$278.73	\$299.44	\$320.15	60"	50CM	Custom Len.		
See Web								
N FEMALE BULKHEAD TO HMCX32 1.2 PLUG SEE MOUNTING HOLE SECTION ON PAGE 369								

Standard Flexible Cable Assemblies								
PE-81mm Coax, 50 Ohm								
Part No. PE3CA1015		Cable Dia.		Attn. @ 1 GHz		Power @ 1 GHz		
1 piece price shown. See web or call for volume pricing.								
3"	6"	12"	-	0.032" dia.	dB/100ft	W		
\$17.70	\$20.40	\$17.70	-	-	-	Custom Len.		
See Web								
N FEMALE BULKHEAD TO UMCX 2.1 PLUG SEE MOUNTING HOLE SECTION ON PAGE 369								
Standard Flexible Cable Assemblies								
PE-81mm Coax, 50 Ohm								
Part No. PE3CA1013		Cable Dia.		Attn. @ 1 GHz		Power @ 1 GHz		
1 piece price shown. See web or call for volume pricing.								
3"	6"	12"	-	0.032" dia.	dB/100ft	W		
\$17.70	\$20.40	\$20.40	-	-	-	Custom Len.		
See Web								
N FEMALE BULKHEAD TO UMCX 2.5 PLUG SEE MOUNTING HOLE SECTION ON PAGE 369								
Standard Flexible Cable Assemblies								
RG178B/U Coax, 50 Ohm								
Part No. PE3CA1011		Cable Dia.		Attn. @ 1 GHz		Power @ 1 GHz		
1 piece price shown. See web or call for volume pricing.								
6"	9"	12"	-	0.070" dia.	dB/100ft	W		
\$18.97	\$17.70	\$17.70	-	-	-	Custom Len.		
See Web								
RG178-DS Coax, 50 Ohm								
Part No. PE3CA1012		Cable Dia.		Attn. @ 1 GHz		Power @ 1 GHz		
1 piece price shown. See web or call for volume pricing.								
6"	9"	12"	-	0.086" dia.	dB/100ft	W		
\$17.70	\$21.53	\$17.70	-	-	-	Custom Len.		
See Web								
PE-81mm Coax, 50 Ohm								
Part No. PE3CA1008		Cable Dia.		Attn. @ 1 GHz		Power @ 1 GHz		
1 piece price shown. See web or call for volume pricing.								
3"	6"	12"	-	0.032" dia.	dB/100ft	W		
\$17.70	\$17.70	\$17.70	-	-	-	Custom Len.		
See Web								
PE-113mm Coax, 50 Ohm								
Part No. PE3CA1009		Cable Dia.		Attn. @ 1 GHz		Power @ 1 GHz		
1 piece price shown. See web or call for volume pricing.								
3"	6"	12"	-	0.044" dia.	dB/100ft	W		
\$17.70	\$17.70	\$20.40	-	-	-	Custom Len.		
See Web								
PE-137mm Coax, 50 Ohm								
Part No. PE3CA1010		Cable Dia.		Attn. @ 1 GHz		Power @ 1 GHz		
1 piece price shown. See web or call for volume pricing.								
3"	6"	12"	-	0.053" dia.	dB/100ft	W		
\$17.70	\$17.70	\$17.70	-	-	-	Custom Len.		
See Web								
N FEMALE 4 HOLE FLANGE TO MMCX PLUG RIGHT ANGLE SEE MOUNTING HOLE SECTION ON PAGE 369								
Low Loss Flexible Cable Assemblies								
LMR-100A-PVC Coax, 50 Ohm								
Part No. PE3C0063		Cable Dia.		Attn. @ 1 GHz		Power @ 1 GHz		
1 piece price shown. See web or call for volume pricing.								
12"	24"	36"	48"	0.110" dia.	24 dB/100ft	W		
\$56.23	\$52.75	\$53.46	\$54.15	60"	-	Custom Len.		
See Web								
NMO MOUNT SEXLESS TO TNC MALE								
Standard Flexible Cable Assemblies								
RG58C/U Coax, 50 Ohm								
Part No. PE37848		Cable Dia.		Attn. @ 1 GHz		Power @ 1 GHz		
1 piece price shown. See web or call for volume pricing.								
60"	120"	180"	-	0.195" dia.	20 dB/100ft	44 W		
\$46.68	\$46.79	\$50.46	-	-	-	Custom Len.		
See Web								
QMA MALE TO QMA MALE								
Low Loss Flexible Cable Assemblies								
PE-C195 Coax, 50 Ohm								
Part No. PE38272		Cable Dia.		Attn. @ 1 GHz		Power @ 1 GHz		
1 piece price shown. See web or call for volume pricing.								
12"	24"	36"	48"	0.195" dia.	11 dB/100ft	150 W		
\$49.60	\$50.32	\$54.14	\$51.74	\$52.46	\$56.56	Custom Len.		
See Web								
Low PIM Corrugated Cable Assemblies								
SPP-250-LLPL Coax, 50 Ohm								

Cable Assemblies

See Our Website For Current Pricing & Real-Time Stock Availability!

Continued on Next Page

For Custom Lengths, Metric Lengths or Special Configurations, Please call (949) 261-1920

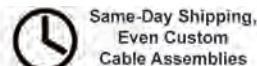
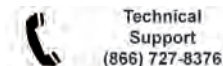

For our complete selection of cable assemblies, please visit our website

Part No.	Cable Dia.	Attn. @ 1 GHz	Power @ 1 GHz
PE3C5869	0.280" dia.	dB/100ft	W
1 piece price shown. See web or call for volume pricing.			
12" 24" 36" 48"	60" 72"	50CM	Custom Len.
\$71.79 \$77.37 \$82.95 \$88.53	\$94.11 \$75.37		See Web
Standard Flexible Cable Assemblies			
RG58C/U Coax, 50 Ohm			
PE38271	0.195" dia.	20 dB/100ft	44 W
1 piece price shown. See web or call for volume pricing.			
12" 24" 36" 48"	60" 72"	50CM	Custom Len.
\$57.47 \$58.20 \$58.94 \$59.68	\$60.42 \$61.16		See Web
RG316/U Coax, 50 Ohm			
PE38270	0.098" dia.	38 dB/100ft	160 W
1 piece price shown. See web or call for volume pricing.			
12" 24" 36" 48"	60" 72"	50CM	Custom Len.
\$61.20 \$64.09 \$71.12 \$69.85	\$77.61 \$75.64		See Web
RG316-DS Coax, 50 Ohm			
PE38161	0.114" dia.	26 dB/100ft	160 W
1 piece price shown. See web or call for volume pricing.			
12" 24" 36" 48"	60" 72"	50CM	Custom Len.
\$96.47 \$99.40 \$102.29 \$105.23	\$108.18 \$111.11		See Web
QMA MALE TO QMA MALE RIGHT ANGLE			
Low PIM Corrugated Cable Assemblies			
SPP-250-LLPL Coax, 50 Ohm			
PE3C5875	0.280" dia.	dB/100ft	W
1 piece price shown. See web or call for volume pricing.			
12" 24" 36" 48"	60" 72"	50CM	Custom Len.
\$73.97 \$79.55 \$85.13 \$90.70	\$96.28 \$77.54		See Web
QMA MALE TO QMA FEMALE			
Low PIM Corrugated Cable Assemblies			
SPP-250-LLPL Coax, 50 Ohm			
PE3C5863	0.280" dia.	dB/100ft	W
1 piece price shown. See web or call for volume pricing.			
12" 24" 36" 48"	60" 72"	50CM	Custom Len.
\$68.20 \$73.78 \$79.36 \$84.94	\$90.52 \$71.77		See Web
QMA MALE TO SMA MALE			
Low PIM Corrugated Cable Assemblies			
SPP-250-LLPL Coax, 50 Ohm			
PE3C5870	0.280" dia.	dB/100ft	W
1 piece price shown. See web or call for volume pricing.			
12" 24" 36" 48"	60" 72"	50CM	Custom Len.
\$64.57 \$70.15 \$75.73 \$81.31	\$86.89 \$68.15		See Web
QMA MALE TO SMA MALE RIGHT ANGLE			
Low PIM Corrugated Cable Assemblies			
SPP-250-LLPL Coax, 50 Ohm			
PE3C5893	0.280" dia.	dB/100ft	W
1 piece price shown. See web or call for volume pricing.			
12" 24" 36" 48"	60" 72"	50CM	Custom Len.
\$66.03 \$71.61 \$77.19 \$82.77	\$88.35 \$69.60		See Web
QMA MALE TO SMA FEMALE			
Low PIM Corrugated Cable Assemblies			
SPP-250-LLPL Coax, 50 Ohm			
PE3C5882	0.280" dia.	dB/100ft	W
1 piece price shown. See web or call for volume pricing.			
12" 24" 36" 48"	60" 72"	50CM	Custom Len.
\$65.30 \$70.88 \$76.46 \$82.04	\$87.62 \$68.88		See Web
QMA MALE RIGHT ANGLE TO QMA MALE RIGHT ANGLE			
Low PIM Corrugated Cable Assemblies			
SPP-250-LLPL Coax, 50 Ohm			
PE3C5877	0.280" dia.	dB/100ft	W
1 piece price shown. See web or call for volume pricing.			
12" 24" 36" 48"	60" 72"	50CM	Custom Len.
\$76.14 \$81.72 \$87.30 \$92.88	\$98.46 \$79.71		See Web

Part No.	Cable Dia.	Attn. @ 1 GHz	Power @ 1 GHz
PE3W06662	0.195" dia.	12 dB/100ft	W
1 piece price shown. See web or call for volume pricing.			
12" 24" 36" 48"	60" 72"	50CM	Custom Len.
\$56.16 \$56.80 \$57.45 \$58.09	\$58.73 \$56.56		See Web
Low PIM Corrugated Cable Assemblies			
SPP-250-LLPL Coax, 50 Ohm			
PE3C5876	0.280" dia.	dB/100ft	W
1 piece price shown. See web or call for volume pricing.			
12" 24" 36" 48"	60" 72"	50CM	Custom Len.
\$66.75 \$72.32 \$77.90 \$83.45	\$89.06 \$70.32		See Web
QMA FEMALE TO SMA MALE			
Low PIM Corrugated Cable Assemblies			
SPP-250-LLPL Coax, 50 Ohm			
PE3C5864	0.280" dia.	dB/100ft	W
1 piece price shown. See web or call for volume pricing.			
12" 24" 36" 48"	60" 72"	50CM	Custom Len.
\$60.98 \$66.56 \$72.14 \$77.72	\$83.30 \$64.55		See Web
QN MALE TO QN MALE			
Low Loss Flexible Cable Assemblies			
PE-C195 Coax, 50 Ohm			
PE38449	0.195" dia.	11 dB/100ft	150 W
1 piece price shown. See web or call for volume pricing.			
12" 24" 36" 48"	60" 72"	50CM	Custom Len.
\$78.70 \$79.37 \$80.02 \$80.74	\$81.41 \$82.12		See Web
QN MALE TO QN MALE RIGHT ANGLE			
Low Loss Flexible Cable Assemblies			
PE-C195 Coax, 50 Ohm			
PE38486	0.195" dia.	11 dB/100ft	150 W
1 piece price shown. See web or call for volume pricing.			
12" 24" 36" 48"	60" 72"	50CM	Custom Len.
\$80.68 \$81.35 \$82.07 \$82.73	\$83.45 \$84.11		See Web
Standard Flexible Cable Assemblies			
RG58C/U Coax, 50 Ohm			
PE38485	0.195" dia.	20 dB/100ft	44 W
1 piece price shown. See web or call for volume pricing.			
12" 24" 36" 48"	60" 72"	50CM	Custom Len.
\$98.31 \$99.05 \$99.79 \$100.51	\$101.25 \$101.99		See Web
QN MALE RIGHT ANGLE TO N FEMALE			
Flexible Cable Assemblies			
LMR-400 Coax, 50 Ohm			
PE3W04619	0.405" dia.	4 dB/100ft	W
1 piece price shown. See web or call for volume pricing.			
12" 24" 36" 48"	60" 72"	50CM	Custom Len.
\$87.59 \$88.83 \$90.08 \$91.33	\$92.57 \$88.39		See Web
SC MALE TO SC MALE			
Standard Flexible Cable Assemblies			
RG8A/U Coax, 50 Ohm			
PE34443	0.405" dia.	8 dB/100ft	190 W
1 piece price shown. See web or call for volume pricing.			
12" 24" 36" 48"	60" 72"	50CM	Custom Len.
\$153.34 \$165.61 \$159.00 \$171.93	\$164.67 \$167.50		See Web
RG214/U Coax, 50 Ohm			
PE3409	0.425" dia.	7 dB/100ft	190 W
1 piece price shown. See web or call for volume pricing.			
12" 24" 36" 48"	60" 72"	50CM	Custom Len.
\$158.25 \$165.59 \$172.90 \$180.24	\$187.56 \$194.87		See Web
RG223/U Coax, 50 Ohm			

Cable Assemblies

See Our Website For Current Pricing & Real-Time Stock Availability!

*Coax Performance at 1 GHz Notes: Cable assembly max frequency may be lower than connector or coax max frequency

For our complete selection of cable assemblies, please visit our website

Part No. PE3348					Cable Dia.	Attn. @ 1 GHz	Power @ 1 GHz	40
1 piece price shown. See web or call for volume pricing.					0.210" dia.	13 dB/100ft	53 W	
12"	24"	36"	48"	60"	72"	Custom Len.		
\$234.80	\$237.69	\$240.63	\$243.57	\$246.45	\$249.39	See Web		
RG225/U Coax, 50 Ohm								
Part No. PE34447					Cable Dia.	Attn. @ 1 GHz	Power @ 1 GHz	41
1 piece price shown. See web or call for volume pricing.					0.430" dia.	dB/100ft	1700 W	
12"	24"	36"	48"	60"	72"	Custom Len.		
\$196.05	\$218.55	\$252.15	\$285.76	\$319.35	\$352.95	See Web		
RG393/U Coax, 50 Ohm								
Part No. PE3416					Cable Dia.	Attn. @ 1 GHz	Power @ 1 GHz	42
1 piece price shown. See web or call for volume pricing.					0.390" dia.	9 dB/100ft	1700 W	
12"	24"	36"	48"	60"	72"	Custom Len.		
\$166.96	\$193.38	\$209.78	\$213.36	\$228.83	\$244.29	See Web		
RG400/U Coax, 50 Ohm								
Part No. PE34453					Cable Dia.	Attn. @ 1 GHz	Power @ 1 GHz	43
1 piece price shown. See web or call for volume pricing.					0.195" dia.	15 dB/100ft	650 W	
12"	24"	36"	48"	60"	72"	Custom Len.		
\$244.87	\$251.92	\$258.93	\$265.95	\$272.97	\$280.00	See Web		

SHV PLUG TO SHV PLUG



Standard Flexible Cable Assemblies

Part No. PE33068					Cable Dia.	Attn. @ 1 GHz	Power @ 1 GHz	44				
1 piece price shown. See web or call for volume pricing.					0.405" dia.	8 dB/100ft	190 W					
12"	24"	36"	48"	60"	72"	Custom Len.						
\$104.96	\$101.85	\$104.68	\$107.52	\$110.35	\$120.62	See Web						
RG8A/U Coax, 50 Ohm												
Part No. PE3815					Cable Dia.	Attn. @ 1 GHz	Power @ 1 GHz	45				
1 piece price shown. See web or call for volume pricing.					0.195" dia.	20 dB/100ft	44 W					
12"	24"	36"	48"	60"	72"	Custom Len.						
\$103.25	\$104.06	\$104.88	\$105.74	\$106.56	\$107.39	See Web						
RG141A/U Coax, 50 Ohm												
Part No. PE34428					Cable Dia.	Attn. @ 1 GHz	Power @ 1 GHz	46				
1 piece price shown. See web or call for volume pricing.					0.190" dia.	13 dB/100ft	650 W					
12"	24"	36"	48"	60"	72"	Custom Len.						
\$122.46	\$121.98	\$136.26	\$134.89	\$150.60	\$157.64	See Web						
RG142B/U Coax, 50 Ohm												
Part No. PE3W03503					Cable Dia.	Attn. @ 1 GHz	Power @ 1 GHz	47				
1 piece price shown. See web or call for volume pricing.					0.195" dia.	13 dB/100ft	600 W					
12"	24"	36"	48"	60"	50CM	Custom Len.						
\$70.25	\$76.14	\$82.04	\$87.94	\$93.84	\$74.02	See Web						
Part No. PE3843												
1 piece price shown. See web or call for volume pricing.					Cable Dia.	Attn. @ 1 GHz	Power @ 1 GHz	48				
12"					24"	36"	48"		60"	72"	Custom Len.	
\$96.35	\$96.63	\$108.50	\$108.10	\$121.14	\$127.33	See Web						
RG174A/U Coax, 50 Ohm												
Part No. PE33706					Cable Dia.	Attn. @ 1 GHz	Power @ 1 GHz	49				
1 piece price shown. See web or call for volume pricing.					0.100" dia.	32 dB/100ft	16 W					
12"	24"	36"	48"	60"	72"	Custom Len.						
\$115.95	\$109.82	\$117.11	\$117.72	\$118.30	\$111.56	See Web						
RG188A/U Coax, 50 Ohm												
Part No. PE34430					Cable Dia.	Attn. @ 1 GHz	Power @ 1 GHz	50				
1 piece price shown. See web or call for volume pricing.					0.110" dia.	26 dB/100ft	160 W					
12"	24"	36"	48"	60"	72"	Custom Len.						
\$117.86	\$120.36	\$115.63	\$117.85	\$120.07	\$130.57	See Web						
RG213/U Coax, 50 Ohm												
Part No. PE35384					Cable Dia.	Attn. @ 1 GHz	Power @ 1 GHz	51				
1 piece price shown. See web or call for volume pricing.					0.405" dia.	9 dB/100ft	190 W					
12"	24"	36"	48"	60"	-	Custom Len.						
\$99.12	\$100.91	\$102.69	\$104.59	\$106.40	-	See Web						
RG214/U Coax, 50 Ohm												
Part No. PE3117					Cable Dia.	Attn. @ 1 GHz	Power @ 1 GHz	52				
1 piece price shown. See web or call for volume pricing.					0.425" dia.	7 dB/100ft	170 W					
12"	24"	36"	48"	60"	72"	Custom Len.						
\$112.04	\$119.82	\$127.60	\$127.67	\$143.77	\$151.69	See Web						
RG223/U Coax, 50 Ohm												
Part No. PE3992					Cable Dia.	Attn. @ 1 GHz	Power @ 1 GHz	53				
1 piece price shown. See web or call for volume pricing.					0.210" dia.	13 dB/100ft	53 W					
12"	24"	36"	48"	60"	72"	Custom Len.						
\$91.63	\$94.75	\$97.86	\$101.16	\$99.71	\$107.51	See Web						
RG225/U Coax, 50 Ohm												
Part No. PE34421					Cable Dia.	Attn. @ 1 GHz	Power @ 1 GHz	54				
1 piece price shown. See web or call for volume pricing.					0.430" dia.	dB/100ft	1700 W					
12"	24"	36"	48"	60"	72"	Custom Len.						
\$132.41	\$168.04	\$203.66	\$222.69	\$277.68	\$287.87	See Web						
RG316/U Coax, 50 Ohm												
Part No. PE34432					Cable Dia.	Attn. @ 1 GHz	Power @ 1 GHz	55				
1 piece price shown. See web or call for volume pricing.					0.098" dia.	38 dB/100ft	160 W					
12"	24"	36"	48"	60"	72"	Custom Len.						
\$110.02	\$112.90	\$115.80	\$118.68	\$121.57	\$132.55	See Web						
RG393/U Coax, 50 Ohm												

Part No. PE3338					Cable Dia.	Attn. @ 1 GHz	Power @ 1 GHz	56
1 piece price shown. See web or call for volume pricing.					0.390" dia.	8 dB/100ft	1700 W	
12"	24"	36"	48"	60"	72"	Custom Len.		
\$109.98	\$132.98	\$149.39	\$166.75	\$171.85	\$187.32	See Web		
RG400/U Coax, 50 Ohm								
Part No. PE34424					Cable Dia.	Attn. @ 1 GHz	Power @ 1 GHz	57
1 piece price shown. See web or call for volume pricing.					0.195" dia.	15 dB/100ft	650 W	
12"	24"	36"	48"	60"	72"	Custom Len.		
\$99.01	\$105.98	\$112.94	\$127.56	\$126.88	\$133.85	See Web		
PE-P195 Coax, 50 Ohm								
Part No. PE39229					Cable Dia.	Attn. @ 1 GHz	Power @ 1 GHz	58
1 piece price shown. See web or call for volume pricing.					0.195" dia.	13 dB/100ft	650 W	
12"	24"	36"	48"	60"	-	Custom Len.		
\$71.96	\$76.74	\$85.60	\$94.45	\$103.30	-	See Web		
RG59B/U Coax, 75 Ohm								
Part No. PE3895					Cable Dia.	Attn. @ 1 GHz	Power @ 1 GHz	59
1 piece price shown. See web or call for volume pricing.					0.242" dia.	12 dB/100ft	77 W	
12"	24"	36"	48"	60"	72"	Custom Len.		
\$91.58	\$92.62	\$93.66	\$94.75	\$95.81	\$96.87	See Web		
RG62A/U Coax, 93 Ohm								
Part No. PE3857					Cable Dia.	Attn. @ 1 GHz	Power @ 1 GHz	60
1 piece price shown. See web or call for volume pricing.					0.242" dia.	13 dB/100ft	77 W	
12"	24"	36"	48"	60"	72"	Custom Len.		
\$95.68	\$97.23	\$98.77	\$100.40	\$97.50	\$103.54	See Web		

SHV PLUG TO SHV JACK BULKHEAD

SEE MOUNTING HOLE SECTION ON PAGE 369



Standard Flexible Cable Assemblies

Part No. PE3W03078					Cable Dia.	Attn. @ 1 GHz	Power @ 1 GHz	61
1 piece price shown. See web or call for volume pricing.					0.195" dia.	dB/100ft	600 W	
12"	24"	36"	48"	60"	50CM	Custom Len.		
\$91.54	\$92.23	\$98.13	\$104.04	\$109.94	\$90.11	See Web		

SHV JACK BULKHEAD TO SHV PLUG

SEE MOUNTING HOLE SECTION ON PAGE 369



Standard Flexible Cable Assemblies

Part No. PE33018					Cable Dia.	Attn. @ 1 GHz	Power @ 1 GHz	62
1 piece price shown. See web or call for volume pricing.					0.242" dia.	12 dB/100ft	77 W	
12"	24"	36"	48"	60"	-	Custom Len.		
\$106.10	\$107.14	\$108.18	\$109.27	\$110.33	-	See Web		

SMA MALE TO SMA MALE



Standard Flexible Cable Assemblies

Part No. PE3M0023					Cable Dia.	Attn. @ 1 GHz	Power @ 1 GHz	63
1 piece price shown. See web or call for volume pricing.					0.195" dia.	dB/100ft	W	
12"	18"	24"	30"	36"	48"	Custom Len.		
\$218.62	\$221.34	\$224.07	\$226.79	\$229.53	\$234.98	See Web		
M17/84-RG223-0XDS2 Coax, 50 Ohm								
Part No. PE3M0051					Cable Dia.	Attn. @ 1 GHz	Power @ 1 GHz	64
1 piece price shown. See web or call for volume pricing.					0.212" dia.	dB/100ft	W	
12"	18"	24"	30"	36"	48"	Custom Len.		
\$222.92	\$227.79	\$232.67	\$237.55	\$242.43	\$252.19	See Web		
M17/128-RG400-27478 Coax, 50 Ohm								
Part No. PE3M0079					Cable Dia.	Attn. @ 1 GHz	Power @ 1 GHz	65
1 piece price shown. See web or call for volume pricing.					0.195" dia.	dB/100ft	W	
12"	18"	24"	30"	36"	48"	Custom Len.		
\$220.10	\$223.57	\$227.04	\$230.51	\$233.98	\$240.92	See Web		
M17/113-RG316-27478 Coax, 50 Ohm								
Part No. PE3M0090					Cable Dia.	Attn. @ 1 GHz	Power @ 1 GHz	66
1 piece price shown. See web or call for volume pricing.					0.098" dia.	dB/100ft	W	
6"	8"	12"	16"	18"	24"	Custom Len.		
\$173.17	\$173.49	\$174.17	\$174.83	\$175.18	\$176.17	See Web		
M17/119-RG174-0XDS2 Coax, 50 Ohm								
Part No. PE3M0105					Cable Dia.	Attn. @ 1 GHz	Power @ 1 GHz	67
1 piece price shown. See web or call for volume pricing.					0.110" dia.	dB/100ft	W	
6"	8"	12"	16"	18"	24"	Custom Len.		
\$172.56	\$172.68	\$172.94	\$173.20	\$173.34	\$173.72	See Web		
M17/28-RG058-0XDS2 Coax, 50 Ohm								
Part No. PE3M0119					Cable Dia.	Attn. @ 1 GHz	Power @ 1 GHz	68
1 piece price shown. See web or call for volume pricing.					0.195" dia.	dB/100ft	W	
12"	18"	24"	30"	36"	48"	Custom Len.		
\$323.12	\$323.71	\$324.31	\$324.91	\$325.51	\$326.70	See Web		

Cable Assemblies

See Our Website For Current Pricing & Real-Time Stock Availability!

Continued on Next Page

For Custom Lengths, Metric Lengths or Special Configurations, Please call (949) 261-1920

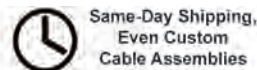
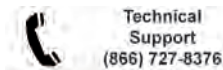

For our complete selection of cable assemblies, please visit our website

SMA MALE TO SMA MALE RIGHT ANGLE							
Standard Flexible Cable Assemblies							
M17/60-RG142-27478 Coax, 50 Ohm							
Part No. PE3M0024	Cable Dia.			Attn. @ 1 GHz	Power @ 1 GHz		
1 piece price shown. See web or call for volume pricing.							
12"	18"	24"	30"	36"	48"	Custom Len.	
\$254.70	\$257.42	\$260.32	\$262.88	\$265.61	\$271.06	See Web	
M17/84-RG223-0XDS2 Coax, 50 Ohm							
Part No. PE3M0052	Cable Dia.			Attn. @ 1 GHz	Power @ 1 GHz		
1 piece price shown. See web or call for volume pricing.							
12"	18"	24"	30"	36"	48"	Custom Len.	
\$259.00	\$263.87	\$268.76	\$273.63	\$278.51	\$288.27	See Web	
M17/128-RG400-27478 Coax, 50 Ohm							
Part No. PE3M0080	Cable Dia.			Attn. @ 1 GHz	Power @ 1 GHz		
1 piece price shown. See web or call for volume pricing.							
12"	18"	24"	30"	36"	48"	Custom Len.	
\$256.19	\$259.65	\$263.13	\$266.59	\$270.07	\$277.01	See Web	
M17/113-RG316-27478 Coax, 50 Ohm							
Part No. PE3M0091	Cable Dia.			Attn. @ 1 GHz	Power @ 1 GHz		
1 piece price shown. See web or call for volume pricing.							
6"	8"	12"	16"	18"	24"	Custom Len.	
\$189.04	\$189.36	\$190.03	\$190.70	\$191.04	\$192.04	See Web	
M17/119-RG174-0XDS2 Coax, 50 Ohm							
Part No. PE3M0106	Cable Dia.			Attn. @ 1 GHz	Power @ 1 GHz		
1 piece price shown. See web or call for volume pricing.							
6"	8"	12"	16"	18"	24"	Custom Len.	
\$188.42	\$188.54	\$188.81	\$189.06	\$189.20	\$189.59	See Web	
M17/28-RG058-0XDS2 Coax, 50 Ohm							
Part No. PE3M0120	Cable Dia.			Attn. @ 1 GHz	Power @ 1 GHz		
1 piece price shown. See web or call for volume pricing.							
12"	18"	24"	30"	36"	48"	Custom Len.	
\$262.45	\$263.04	\$263.65	\$264.24	\$264.84	\$266.04	See Web	
SMA MALE TO SMA FEMALE BULKHEAD							
SEE MOUNTING HOLE SECTION ON PAGE 369							
Standard Flexible Cable Assemblies							
M17/113-RG316-27478 Coax, 50 Ohm							
Part No. PE3M0092	Cable Dia.			Attn. @ 1 GHz	Power @ 1 GHz		
1 piece price shown. See web or call for volume pricing.							
6"	8"	12"	16"	18"	24"	Custom Len.	
\$179.79	\$180.11	\$180.79	\$181.45	\$181.79	\$182.79	See Web	
M17/119-RG174-0XDS2 Coax, 50 Ohm							
Part No. PE3M0107	Cable Dia.			Attn. @ 1 GHz	Power @ 1 GHz		
1 piece price shown. See web or call for volume pricing.							
6"	8"	12"	16"	18"	24"	Custom Len.	
\$179.18	\$179.30	\$179.56	\$179.82	\$179.95	\$180.34	See Web	
SMA MALE TO TNC MALE							
Standard Flexible Cable Assemblies							
M17/60-RG142-27478 Coax, 50 Ohm							
Part No. PE3M0026	Cable Dia.			Attn. @ 1 GHz	Power @ 1 GHz		
1 piece price shown. See web or call for volume pricing.							
12"	18"	24"	30"	36"	48"	Custom Len.	
\$187.90	\$190.63	\$193.36	\$196.08	\$198.81	\$204.27	See Web	
M17/84-RG223-0XDS2 Coax, 50 Ohm							
Part No. PE3M0054	Cable Dia.			Attn. @ 1 GHz	Power @ 1 GHz		
1 piece price shown. See web or call for volume pricing.							
12"	18"	24"	30"	36"	48"	Custom Len.	
\$192.20	\$197.08	\$201.96	\$206.83	\$211.72	\$221.47	See Web	
M17/128-RG400-27478 Coax, 50 Ohm							
Part No. PE3M0082	Cable Dia.			Attn. @ 1 GHz	Power @ 1 GHz		
1 piece price shown. See web or call for volume pricing.							
12"	18"	24"	30"	36"	48"	Custom Len.	
\$189.39	\$192.86	\$196.33	\$199.80	\$203.27	\$210.21	See Web	
M17/113-RG316-27478 Coax, 50 Ohm							
Part No. PE3M0096	Cable Dia.			Attn. @ 1 GHz	Power @ 1 GHz		
1 piece price shown. See web or call for volume pricing.							
6"	8"	12"	16"	18"	24"	Custom Len.	
\$180.75	\$181.08	\$181.75	\$182.42	\$182.76	\$183.76	See Web	
M17/119-RG174-0XDS2 Coax, 50 Ohm							
Part No. PE3M0111	Cable Dia.			Attn. @ 1 GHz	Power @ 1 GHz		
1 piece price shown. See web or call for volume pricing.							
6"	8"	12"	16"	18"	24"	Custom Len.	
\$180.14	\$180.26	\$180.53	\$180.78	\$180.92	\$181.31	See Web	
M17/28-RG058-0XDS2 Coax, 50 Ohm							

SMA MALE TO 1.85MM MALE							
Standard Formable Cable Assemblies							
PE-SR405FL Coax, 50 Ohm							
Part No. PE36541	Cable Dia.			Attn. @ 1 GHz	Power @ 1 GHz		
1 piece price shown. See web or call for volume pricing.							
6"	12"	18"	24"	36"	48"	Custom Len.	
\$194.44	\$194.44	\$211.78	\$205.13	\$215.83	\$226.51	See Web	
Standard Semi-Rigid Cable Assemblies							
RG405/U Coax, 50 Ohm							
Part No. PE36539	Cable Dia.			Attn. @ 1 GHz	Power @ 1 GHz		
1 piece price shown. See web or call for volume pricing.							
6"	12"	18"	24"	36"	48"	Custom Len.	
\$198.31	\$190.49	\$193.94	\$197.37	\$204.24	\$211.10	See Web	
SMA MALE TO 7/16 DIN MALE							
Low PIM Formable Cable Assemblies							
PE-SR402FLJ Low PIM Coax, 50 Ohm							
Part No. PE3C2007	Cable Dia.			Attn. @ 1 GHz	Power @ 1 GHz		
1 piece price shown. See web or call for volume pricing.							
100CM	200CM	-	-	-	-	Custom Len.	
\$108.59	\$117.38	-	-	-	-	See Web	
Standard Formable Cable Assemblies							
PE-SR401FL Coax, 50 Ohm							
Part No. PE36169	Cable Dia.			Attn. @ 1 GHz	Power @ 1 GHz		
1 piece price shown. See web or call for volume pricing.							
12"	24"	36"	48"	60"	72"	Custom Len.	
\$222.33	\$237.27	\$252.22	\$267.16	\$282.11	\$297.04	See Web	
Standard Flexible Cable Assemblies							
RG8A/U Coax, 50 Ohm							
Part No. PE36157	Cable Dia.			Attn. @ 1 GHz	Power @ 1 GHz		
1 piece price shown. See web or call for volume pricing.							
12"	24"	36"	48"	60"	72"	Custom Len.	
\$213.08	\$215.84	\$218.54	\$221.31	\$224.06	\$226.77	See Web	
RG142B/U Coax, 50 Ohm							
Part No. PE3224	Cable Dia.			Attn. @ 1 GHz	Power @ 1 GHz		
1 piece price shown. See web or call for volume pricing.							
12"	24"	36"	48"	60"	72"	Custom Len.	
\$70.65	\$76.19	\$81.71	\$87.29	\$92.81	\$98.38	See Web	
RG223/U Coax, 50 Ohm							
Part No. PE36161	Cable Dia.			Attn. @ 1 GHz	Power @ 1 GHz		
1 piece price shown. See web or call for volume pricing.							
12"	24"	36"	48"	60"	72"	Custom Len.	
\$68.01	\$75.20	\$73.84	\$76.78	\$79.67	\$82.60	See Web	
SMA MALE TO BNC MALE							
Flexible Cable Assemblies							
LMR-240 Coax, 50 Ohm							
Part No. PE3C1830	Cable Dia.			Attn. @ 1 GHz	Power @ 1 GHz		
1 piece price shown. See web or call for volume pricing.							
12"	24"	36"	48"	60"	50CM	Custom Len.	
\$38.45	\$39.40	\$40.34	\$41.29	\$42.24	\$39.06	See Web	
Low Loss Flexible Cable Assemblies							
LMR-195 Coax, 50 Ohm							
Part No. PE3C0051	Cable Dia.			Attn. @ 1 GHz	Power @ 1 GHz		
1 piece price shown. See web or call for volume pricing.							
12"	24"	36"	48"	60"	-	Custom Len.	
\$33.11	\$33.86	\$34.61	\$35.41	\$36.17	-	See Web	
Standard Formable Cable Assemblies							
PE-SR402FL Coax, 50 Ohm							
Part No. PE34008	Cable Dia.			Attn. @ 1 GHz	Power @ 1 GHz		
1 piece price shown. See web or call for volume pricing.							
12"	24"	36"	48"	60"	-	Custom Len.	
\$69.34	\$77.43	\$79.28	\$86.82	\$102.29	-	See Web	
PE-SR405FL Coax, 50 Ohm							
Part No. PE35109	Cable Dia.			Attn. @ 1 GHz	Power @ 1 GHz		
1 piece price shown. See web or call for volume pricing.							
12"	24"	36"	48"	60"	-	Custom Len.	
\$70.06	\$81.66	\$93.25	\$104.85	\$116.44	-	See Web	

Cable Assemblies
See Our Website For Current Pricing & Real-Time Stock Availability!

*Coax Performance at 1 GHz Notes: Cable assembly max frequency may be lower than connector or coax max frequency

For our complete selection of cable assemblies, please visit our website

Standard Flexible Cable Assemblies							
RG58C/U Coax, 50 Ohm							
Part No. PE3615	Cable Dia.			Attn. @ 1 GHz	Power @ 1 GHz		
1 piece price shown. See web or call for volume pricing.							
12"	24"	36"	48"	0.195" dia.	20 dB/100ft	44 W	94
\$39.92	\$40.73	\$41.54	\$42.40	60"	72"	Custom Len.	
See Web							
RG142B/U Coax, 50 Ohm							
Part No. PE3696	Cable Dia.			Attn. @ 1 GHz	Power @ 1 GHz		
1 piece price shown. See web or call for volume pricing.							
12"	24"	36"	48"	0.195" dia.	13 dB/100ft	650 W	95
\$39.24	\$48.46	\$54.54	\$60.97	60"	72"	Custom Len.	
See Web							
RG174A/U Coax, 50 Ohm							
Part No. PE3C3328	Cable Dia.			Attn. @ 1 GHz	Power @ 1 GHz		
1 piece price shown. See web or call for volume pricing.							
12"	24"	36"	48"	0.110" dia.	32 dB/100ft	17 W	96
\$40.44	\$41.02	\$41.60	\$42.20	60"	72"	Custom Len.	
See Web							
RG178B/U Coax, 50 Ohm							
Part No. PE33258	Cable Dia.			Attn. @ 1 GHz	Power @ 1 GHz		
1 piece price shown. See web or call for volume pricing.							
12"	24"	36"	48"	0.072" dia.	44 dB/100ft	78 W	97
\$66.25	\$67.31	\$68.37	\$69.49	60"	72"	Custom Len.	
See Web							
RG188A/U Coax, 50 Ohm							
Part No. PE3C2035	Cable Dia.			Attn. @ 1 GHz	Power @ 1 GHz		
1 piece price shown. See web or call for volume pricing.							
12"	24"	36"	48"	0.110" dia.	26 dB/100ft	160 W	98
\$41.41	\$43.91	\$46.40	\$49.04	60"	72"	Custom Len.	
See Web							
RG196A/U Coax, 50 Ohm							
Part No. PE33523	Cable Dia.			Attn. @ 1 GHz	Power @ 1 GHz		
1 piece price shown. See web or call for volume pricing.							
12"	24"	36"	48"	0.080" dia.	49 dB/100ft	78 W	99
\$69.19	\$70.60	\$66.81	\$68.18	60"	72"	Custom Len.	
See Web							
RG214/U Coax, 50 Ohm							
Part No. PE33519	Cable Dia.			Attn. @ 1 GHz	Power @ 1 GHz		
1 piece price shown. See web or call for volume pricing.							
12"	24"	36"	48"	0.425" dia.	7 dB/100ft	190 W	1
\$126.36	\$133.73	\$141.13	\$148.49	60"	72"	Custom Len.	
See Web							
RG223/U Coax, 50 Ohm							
Part No. PE3562	Cable Dia.			Attn. @ 1 GHz	Power @ 1 GHz		
1 piece price shown. See web or call for volume pricing.							
12"	24"	36"	48"	0.210" dia.	13 dB/100ft	53 W	2
\$38.03	\$40.93	\$43.84	\$46.73	60"	72"	Custom Len.	
See Web							
RG316/U Coax, 50 Ohm							
Part No. PE3C2360	Cable Dia.			Attn. @ 1 GHz	Power @ 1 GHz		
1 piece price shown. See web or call for volume pricing.							
12"	24"	36"	48"	0.098" dia.	58 dB/100ft	160 W	3
\$37.56	\$40.68	\$43.80	\$47.11	60"	72"	Custom Len.	
See Web							
RG400/U Coax, 50 Ohm							
Part No. PE3613	Cable Dia.			Attn. @ 1 GHz	Power @ 1 GHz		
1 piece price shown. See web or call for volume pricing.							
12"	24"	36"	48"	0.195" dia.	15 dB/100ft	650 W	4
\$50.17	\$57.57	\$64.97	\$72.79	60"	72"	Custom Len.	
See Web							
PE-195 Coax, 50 Ohm							
Part No. PE33989	Cable Dia.			Attn. @ 1 GHz	Power @ 1 GHz		
1 piece price shown. See web or call for volume pricing.							
12"	24"	36"	48"	0.195" dia.	13 dB/100ft	650 W	5
\$48.56	\$58.14	\$67.71	\$77.85	60"	-	Custom Len.	
See Web							
RG55B/U Coax, 53 Ohm							
Part No. PE3479	Cable Dia.			Attn. @ 1 GHz	Power @ 1 GHz		
1 piece price shown. See web or call for volume pricing.							
12"	24"	36"	48"	0.202" dia.	17 dB/100ft	53 W	6
\$36.28	\$41.05	\$43.64	\$46.38	60"	72"	Custom Len.	
See Web							
RG59B/U Coax, 75 Ohm							
Part No. PE3539	Cable Dia.			Attn. @ 1 GHz	Power @ 1 GHz		
1 piece price shown. See web or call for volume pricing.							
12"	24"	36"	48"	0.242" dia.	12 dB/100ft	77 W	7
\$52.16	\$50.16	\$51.13	\$52.09	60"	72"	Custom Len.	
See Web							
RG179B/U Coax, 75 Ohm							
Part No. PE3C3321	Cable Dia.			Attn. @ 1 GHz	Power @ 1 GHz		
1 piece price shown. See web or call for volume pricing.							
12"	24"	36"	48"	0.100" dia.	29 dB/100ft	240 W	8
\$42.38	\$41.60	\$43.97	\$46.33	60"	72"	Custom Len.	
See Web							

SMA MALE TO BNC MALE RIGHT ANGLE



Low Loss Flexible Cable Assemblies

LMR-195 Coax, 50 Ohm							
Part No. PE3C0040	Cable Dia.			Attn. @ 1 GHz	Power @ 1 GHz		
1 piece price shown. See web or call for volume pricing.							
12"	24"	36"	48"	0.195" dia.	12 dB/100ft	W	9
\$46.83	\$47.58	\$48.33	\$49.12	60"	-	Custom Len.	
See Web							

SMA MALE TO FAKRA PLUG



Low Loss Flexible Cable Assemblies

PE-C100-LSZH Coax, 50 Ohm							
Part No. PE39342A	Cable Dia.			Attn. @ 1 GHz	Power @ 1 GHz		
1 piece price shown. See web or call for volume pricing.							
12"	24"	36"	48"	0.109" dia.	25 dB/100ft	W	10
\$31.11	\$35.54	\$32.54	\$33.21	60"	-	Custom Len.	
See Web							
Part No. PE39342C	Cable Dia.			Attn. @ 1 GHz	Power @ 1 GHz		
1 piece price shown. See web or call for volume pricing.							
12"	24"	36"	48"	0.109" dia.	25 dB/100ft	W	11
\$34.22	\$35.43	\$36.64	\$37.84	60"	-	Custom Len.	
See Web							
Part No. PE39342Z	Cable Dia.			Attn. @ 1 GHz	Power @ 1 GHz		
1 piece price shown. See web or call for volume pricing.							
12"	24"	36"	48"	0.109" dia.	25 dB/100ft	W	12
\$36.97	\$35.43	\$36.64	\$37.84	60"	-	Custom Len.	
See Web							

Standard Flexible Cable Assemblies

RG174A/U Coax, 50 Ohm							
Part No. PE39197C	Cable Dia.			Attn. @ 1 GHz	Power @ 1 GHz		
1 piece price shown. See web or call for volume pricing.							
12"	24"	36"	48"	0.100" dia.	32 dB/100ft	16 W	13
\$43.02	\$40.27	\$40.70	\$41.13	60"	-	Custom Len.	
See Web							
Part No. PE39197D	Cable Dia.			Attn. @ 1 GHz	Power @ 1 GHz		
1 piece price shown. See web or call for volume pricing.							
12"	24"	36"	48"	0.100" dia.	32 dB/100ft	16 W	14
\$43.02	\$40.27	\$40.70	\$41.13	60"	-	Custom Len.	
See Web							
Part No. PE39197H	Cable Dia.			Attn. @ 1 GHz	Power @ 1 GHz		
1 piece price shown. See web or call for volume pricing.							
12"	24"	36"	48"	0.100" dia.	32 dB/100ft	16 W	15
\$36.21	\$36.76	\$37.29	\$37.77	60"	-	Custom Len.	
See Web							
Part No. PE39197I	Cable Dia.			Attn. @ 1 GHz	Power @ 1 GHz		
1 piece price shown. See web or call for volume pricing.							
12"	24"	36"	48"	0.100" dia.	32 dB/100ft	16 W	16
\$36.21	\$36.76	\$37.29	\$37.77	60"	-	Custom Len.	
See Web							
Part No. PE39197Z	Cable Dia.			Attn. @ 1 GHz	Power @ 1 GHz		
1 piece price shown. See web or call for volume pricing.							
12"	24"	36"	48"	0.100" dia.	32 dB/100ft	16 W	17
\$43.81	\$44.40	\$40.70	\$41.13	60"	-	Custom Len.	
See Web							
RG316/U Coax, 50 Ohm							
Part No. PE39343A	Cable Dia.			Attn. @ 1 GHz	Power @ 1 GHz		
1 piece price shown. See web or call for volume pricing.							
12"	24"	36"	48"	0.098" dia.	38 dB/100ft	160 W	18
\$42.47	\$45.36	\$48.26	\$51.14	60"	-	Custom Len.	
See Web							
Part No. PE39343C	Cable Dia.			Attn. @ 1 GHz	Power @ 1 GHz		
1 piece price shown. See web or call for volume pricing.							
12"	24"	36"	48"	0.098" dia.	38 dB/100ft	160 W	19
\$46.72	\$45.36	\$48.26	\$51.14	60"	-	Custom Len.	
See Web							
Part No. PE39343D	Cable Dia.			Attn. @ 1 GHz	Power @ 1 GHz		
1 piece price shown. See web or call for volume pricing.							
12"	24"	36"	48"	0.098" dia.	38 dB/100ft	160 W	20
\$46.24	\$44.92	\$47.80	\$50.69	60"	-	Custom Len.	
See Web							
Part No. PE39343I	Cable Dia.			Attn. @ 1 GHz	Power @ 1 GHz		
1 piece price shown. See web or call for volume pricing.							
12"	24"	36"	48"	0.098" dia.	38 dB/100ft	160 W	21
\$38.61	\$41.42	\$44.31	\$47.20	60"	-	Custom Len.	
See Web							
Part No. PE39343Z	Cable Dia.			Attn. @ 1 GHz	Power @ 1 GHz		
1 piece price shown. See web or call for volume pricing.							
12"	24"	36"	48"	0.098" dia.	38 dB/100ft	160 W	22
\$46.72	\$45.36	\$48.26	\$51.14	60"	-	Custom Len.	
See Web							

SMA MALE TO FAKRA JACK



Low Loss Flexible Cable Assemblies

PE-C100-LSZH Coax, 50 Ohm							
Part No. PE39347A	Cable Dia.			Attn. @ 1 GHz	Power @ 1 GHz		
1 piece price shown. See web or call for volume pricing.							
12"	24"	36"	48"	0.109" dia.	25 dB/100ft	W	23
\$35.41	\$36.61	\$41.60	\$39.01	60"	-	Custom Len.	
See Web							
Part No. PE39347C	Cable Dia.			Attn. @ 1 GHz	Power @ 1 GHz		
1 piece price shown. See web or call for volume pricing.							
12"	24"	36"	48"	0.109" dia.	25 dB/100ft	W	24
\$35.41	\$36.61	\$41.60	\$39.01	60"	-	Custom Len.	
See Web							
Part No. PE39347Z	Cable Dia.			Attn. @ 1 GHz	Power @ 1 GHz		
1 piece price shown. See web or call for volume pricing.							
12"	24"	36"	48"	0.109" dia.	25 dB/100ft	W	25
\$36.29	\$37.61	\$38.94	\$37.22	60"	-	Custom Len.	
See Web							

Standard Flexible Cable Assemblies

Cable Assemblies

See Our Website For Current Pricing & Real-Time Stock Availability!

Continued on Next Page

For Custom Lengths, Metric Lengths or Special Configurations, Please call (949) 261-1920

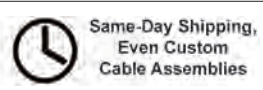
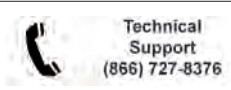

For our complete selection of cable assemblies, please visit our website

Cable Assemblies
See Our Website For Current Pricing & Real-Time Stock Availability!

RG174A/U Coax, 50 Ohm						
Part No.	Cable Dia.				Attn. @ 1 GHz	Power @ 1 GHz
Part No. PE39199A	0.100" dia.				32 dB/100ft	16 W
1 piece price shown. See web or call for volume pricing.						
12"	24"	36"	48"	60"	-	Custom Len.
\$43.02	\$40.27	\$40.70	\$41.13	\$41.58	-	See Web
Part No. PE39199C						
1 piece price shown. See web or call for volume pricing.						
12"	24"	36"	48"	60"	-	Custom Len.
\$43.81	\$40.27	\$40.70	\$45.59	\$41.58	-	See Web
Part No. PE39199D						
1 piece price shown. See web or call for volume pricing.						
12"	24"	36"	48"	60"	-	Custom Len.
\$39.84	\$43.60	\$40.70	\$44.79	\$41.58	-	See Web
Part No. PE39199H						
1 piece price shown. See web or call for volume pricing.						
12"	24"	36"	48"	60"	-	Custom Len.
\$39.84	\$44.40	\$40.70	\$41.13	\$41.58	-	See Web
Part No. PE39199J						
1 piece price shown. See web or call for volume pricing.						
12"	24"	36"	48"	60"	-	Custom Len.
\$36.21	\$36.76	\$37.29	\$37.77	\$38.31	-	See Web
Part No. PE39199K						
1 piece price shown. See web or call for volume pricing.						
12"	24"	36"	48"	60"	-	Custom Len.
\$39.84	\$40.27	\$40.70	\$41.13	\$41.58	-	See Web
Part No. PE39199Z						
1 piece price shown. See web or call for volume pricing.						
12"	24"	36"	48"	60"	-	Custom Len.
\$43.02	\$43.60	\$44.18	\$44.79	\$45.38	-	See Web
RG316/U Coax, 50 Ohm						
Part No. PE39348A	0.098" dia.				38 dB/100ft	160 W
1 piece price shown. See web or call for volume pricing.						
12"	24"	36"	48"	60"	-	Custom Len.
\$42.47	\$45.36	\$48.26	\$51.14	\$54.03	-	See Web
Part No. PE39348B						
1 piece price shown. See web or call for volume pricing.						
12"	24"	36"	48"	60"	-	Custom Len.
\$42.47	\$45.36	\$48.26	\$51.14	\$54.03	-	See Web
Part No. PE39348C						
1 piece price shown. See web or call for volume pricing.						
12"	24"	36"	48"	60"	-	Custom Len.
\$45.87	\$49.00	\$48.26	\$51.14	\$58.61	-	See Web
Part No. PE39348H						
1 piece price shown. See web or call for volume pricing.						
12"	24"	36"	48"	60"	-	Custom Len.
\$42.47	\$45.36	\$48.26	\$51.14	\$59.46	-	See Web
Part No. PE39348K						
1 piece price shown. See web or call for volume pricing.						
12"	24"	36"	48"	60"	-	Custom Len.
\$42.47	\$49.85	\$52.97	\$51.14	\$54.03	-	See Web
Part No. PE39348Z						
1 piece price shown. See web or call for volume pricing.						
12"	24"	36"	48"	60"	-	Custom Len.
\$45.87	\$45.36	\$48.26	\$55.43	\$58.61	-	See Web

SMA MALE TO MC-CARD PLUG



Standard Flexible Cable Assemblies

RG174A/U Coax, 50 Ohm						
Part No.	Cable Dia.				Attn. @ 1 GHz	Power @ 1 GHz
Part No. PE36112	0.100" dia.				32 dB/100ft	16 W
1 piece price shown. See web or call for volume pricing.						
12"	24"	36"	48"	60"	72"	Custom Len.
\$40.65	\$41.12	\$41.57	\$41.98	\$42.45	\$42.87	See Web
RG316/U Coax, 50 Ohm						
Part No. PE36108	0.098" dia.				38 dB/100ft	160 W
1 piece price shown. See web or call for volume pricing.						
12"	24"	36"	48"	60"	72"	Custom Len.
\$47.54	\$46.24	\$49.23	\$52.24	\$55.23	\$58.23	See Web

SMA MALE TO MINI UHF MALE



Standard Flexible Cable Assemblies

RG58C/U Coax, 50 Ohm						
Part No.	Cable Dia.				Attn. @ 1 GHz	Power @ 1 GHz
Part No. PE3273	0.195" dia.				20 dB/100ft	44 W
1 piece price shown. See web or call for volume pricing.						
12"	24"	36"	48"	60"	72"	Custom Len.
\$38.64	\$39.38	\$40.12	\$40.85	\$41.59	\$42.33	See Web
RG142B/U Coax, 50 Ohm						
Part No. PE3275	0.195" dia.				13 dB/100ft	W
1 piece price shown. See web or call for volume pricing.						
12"	24"	36"	48"	60"	72"	Custom Len.
\$38.59	\$44.32	\$50.06	\$55.79	\$61.52	\$67.25	See Web

RG223/U Coax, 50 Ohm						
Part No.	Cable Dia.				Attn. @ 1 GHz	Power @ 1 GHz
Part No. PE3271	0.209" dia.				13 dB/100ft	50 W
1 piece price shown. See web or call for volume pricing.						
12"	24"	36"	48"	60"	72"	Custom Len.
\$40.04	\$39.31	\$42.20	\$45.10	\$48.00	\$50.90	See Web
RG400/U Coax, 50 Ohm						
Part No. PE3278	0.195" dia.				15 dB/100ft	600 W
1 piece price shown. See web or call for volume pricing.						
12"	24"	36"	48"	60"	72"	Custom Len.
\$43.17	\$50.20	\$57.21	\$64.24	\$71.27	\$78.29	See Web

SMA MALE TO MMCX PLUG



Standard Flexible Cable Assemblies

RG174A/U Coax, 50 Ohm						
Part No.	Cable Dia.				Attn. @ 1 GHz	Power @ 1 GHz
Part No. PE34069	0.100" dia.				32 dB/100ft	16 W
1 piece price shown. See web or call for volume pricing.						
12"	24"	36"	48"	60"	72"	Custom Len.
\$52.94	\$53.52	\$54.10	\$54.71	\$50.76	\$51.19	See Web
RG178B/U Coax, 50 Ohm						
Part No. PE34374	0.072" dia.				44 dB/100ft	78 W
1 piece price shown. See web or call for volume pricing.						
12"	24"	36"	48"	60"	72"	Custom Len.
\$60.94	\$62.00	\$58.35	\$59.31	\$60.26	\$66.34	See Web
RG188A/U Coax, 50 Ohm						
Part No. PE34887	0.110" dia.				26 dB/100ft	160 W
1 piece price shown. See web or call for volume pricing.						
12"	24"	36"	48"	60"	72"	Custom Len.
\$55.96	\$58.45	\$60.95	\$63.59	\$59.73	\$61.96	See Web
RG316/U Coax, 50 Ohm						
Part No. PE34122	0.098" dia.				38 dB/100ft	160 W
1 piece price shown. See web or call for volume pricing.						
12"	24"	36"	48"	60"	72"	Custom Len.
\$54.98	\$58.11	\$61.24	\$64.54	\$62.46	\$70.91	See Web

SMA MALE TO MMCX PLUG RIGHT ANGLE



Standard Formable Cable Assemblies

PE-SR405FLJ Coax, 50 Ohm						
Part No.	Cable Dia.				Attn. @ 1 GHz	Power @ 1 GHz
Part No. PE39564	0.098" dia.				20 dB/100ft	130 W
1 piece price shown. See web or call for volume pricing.						
6"	9"	12"	24"	-	-	Custom Len.
\$41.54	\$39.46	\$41.54	\$50.52	-	-	See Web

Standard Flexible Cable Assemblies

RG178B/U Coax, 50 Ohm						
Part No.	Cable Dia.				Attn. @ 1 GHz	Power @ 1 GHz
Part No. PE34777	0.072" dia.				44 dB/100ft	78 W
1 piece price shown. See web or call for volume pricing.						
12"	24"	36"	48"	60"	-	Custom Len.
\$66.12	\$67.18	\$68.24	\$69.36	\$70.44	-	See Web

SMA MALE TO N MALE



Flexible Cable Assemblies

LMR-240 Coax, 50 Ohm						
Part No.	Cable Dia.				Attn. @ 1 GHz	Power @ 1 GHz
Part No. PE3C1982	0.240" dia.				8 dB/100ft	W
1 piece price shown. See web or call for volume pricing.						
12"	24"	36"	48"	60"	50CM	Custom Len.
\$38.45	\$39.39	\$40.33	\$41.28	\$42.22	\$39.06	See Web
LMR-195 Coax, 50 Ohm						
Part No. PE3C0121	0.195" dia.				12 dB/100ft	W
1 piece price shown. See web or call for volume pricing.						
12"	24"	36"	48"	60"	-	Custom Len.
\$46.85	\$47.61	\$48.36	\$49.14	\$49.90	-	See Web
Precision Formable Cable Assemblies						
PE-80TEST Coax, 50 Ohm						
Part No. PE3TC0105	0.195" dia.				dB/100ft	W
1 piece price shown. See web or call for volume pricing.						
24"	48"	72"	-	-	-	Custom Len.
\$329.78	\$415.52	\$501.27	-	-	-	See Web
PE-90TEST Coax, 50 Ohm						
Part No. PE3TC0303	0.151" dia.				dB/100ft	W
1 piece price shown. See web or call for volume pricing.						
24"	48"	72"	-	-	-	Custom Len.
\$269.58	\$344.28	\$422.23	-	-	-	See Web

Low Loss Flexible Cable Assemblies

PE-C100-LSZH Coax, 50 Ohm

*Coax Performance at 1 GHz Notes: Cable assembly max frequency may be lower than connector or coax max frequency

For our complete selection of cable assemblies, please visit our website

Part No.	Cable Dia.				Attn. @ 1 GHz	Power @ 1 GHz
Part No. PE38433	1 piece price shown. See web or call for volume pricing.				0.109" dia.	25 dB/100ft
12"	24"	36"	48"	60"	-	Custom Len.
\$42.27	\$44.25	\$46.29	\$50.55	\$50.32	-	See Web
PE-C195 Coax, 50 Ohm						
Part No. PE35981	1 piece price shown. See web or call for volume pricing.				0.195" dia.	11 dB/100ft
12"	24"	36"	48"	60"	-	Custom Len.
\$41.40	\$42.18	\$42.97	\$43.79	\$44.59	-	See Web
PE-C200 Coax, 50 Ohm						
Part No. PE36200	1 piece price shown. See web or call for volume pricing.				0.195" dia.	11 dB/100ft
12"	24"	36"	48"	60"	-	Custom Len.
\$42.01	\$45.36	\$46.19	\$52.29	\$56.49	-	See Web
PE-C240 Coax, 50 Ohm						
Part No. PE38645	1 piece price shown. See web or call for volume pricing.				0.240" dia.	9 dB/100ft
12"	24"	36"	48"	60"	-	Custom Len.
\$52.90	\$57.21	\$58.34	\$59.25	\$60.70	-	See Web
LMR-240 Coax, 50 Ohm						
Part No. PE3C0044	1 piece price shown. See web or call for volume pricing.				0.240" dia.	8 dB/100ft
12"	24"	36"	48"	60"	-	Custom Len.
\$53.51	\$54.49	\$55.46	\$54.36	\$55.34	-	See Web
Part No. PE3C0102						
1 piece price shown. See web or call for volume pricing.				0.240" dia.	8 dB/100ft	W
12"	24"	36"	48"	60"	-	Custom Len.
\$41.52	\$42.50	\$43.47	\$44.50	\$45.50	-	See Web
LMR-400 Coax, 50 Ohm						
Part No. PE3W00832	1 piece price shown. See web or call for volume pricing.				0.405" dia.	4 dB/100ft
12"	24"	36"	48"	60"	50CM	Custom Len.
\$60.71	\$62.04	\$63.37	\$64.70	\$66.04	\$61.56	See Web
PE-P142LL Coax, 50 Ohm						
Part No. PE3C0689	1 piece price shown. See web or call for volume pricing.				0.195" dia.	7 dB/100ft
12"	24"	36"	48"	60"	50CM	Custom Len.
\$128.26	\$144.50	\$160.73	\$176.97	\$193.21	\$138.66	See Web
PE-P142LL-27478 Coax, 50 Ohm						
Part No. PE3M0132	1 piece price shown. See web or call for volume pricing.				0.195" dia.	dB/100ft
12"	18"	24"	36"	48"	60"	Custom Len.
\$358.92	\$367.40	\$375.88	\$392.84	\$409.79	\$426.75	See Web
PE-P160LL-27478 Coax, 50 Ohm						
Part No. PE3M0186	1 piece price shown. See web or call for volume pricing.				0.160" dia.	dB/100ft
8"	12"	18"	24"	30"	36"	Custom Len.
\$340.63	\$345.53	\$352.89	\$360.23	\$367.59	\$374.93	See Web
PE-P300LL-27478 Coax, 50 Ohm						
Part No. PE3M0229	1 piece price shown. See web or call for volume pricing.				0.300" dia.	dB/100ft
12"	18"	24"	36"	48"	60"	Custom Len.
\$405.42	\$419.57	\$433.72	\$462.02	\$490.32	\$518.63	See Web
LMR-240-UF Coax, 50 Ohm						
Part No. PE3W01626	1 piece price shown. See web or call for volume pricing.				* dia.	dB/100ft
12"	24"	36"	48"	60"	50CM	Custom Len.
\$44.91	\$46.23	\$47.54	\$48.86	\$50.18	\$45.75	See Web

Standard Formable Cable Assemblies

Part No.	Cable Dia.				Attn. @ 1 GHz	Power @ 1 GHz
Part No. PE34263	1 piece price shown. See web or call for volume pricing.				* dia.	8 dB/100ft
6"	12"	18"	24"	36"	48"	Custom Len.
\$131.41	\$139.34	\$139.15	\$146.85	\$172.01	\$177.66	See Web
PE-SR402FL Coax, 50 Ohm						
Part No. PE3448	1 piece price shown. See web or call for volume pricing.				* dia.	12 dB/100ft
6"	12"	18"	24"	36"	48"	Custom Len.
\$69.22	\$73.14	\$77.18	\$81.22	\$84.08	\$91.61	See Web
PE-SR405FL Coax, 50 Ohm						
Part No. PE3657	1 piece price shown. See web or call for volume pricing.				* dia.	23 dB/100ft
6"	12"	18"	24"	36"	48"	Custom Len.
\$81.73	\$82.30	\$87.64	\$92.98	\$103.68	\$114.37	See Web

Standard Flexible Cable Assemblies

Part No.	Cable Dia.				Attn. @ 1 GHz	Power @ 1 GHz
Part No. PE3323	1 piece price shown. See web or call for volume pricing.				0.405" dia.	8 dB/100ft
12"	24"	36"	48"	60"	72"	Custom Len.
\$131.53	\$126.91	\$137.67	\$132.58	\$135.41	\$138.24	See Web
RG142B/U Coax, 50 Ohm						

Part No.	Cable Dia.				Attn. @ 1 GHz	Power @ 1 GHz
Part No. PE3568	1 piece price shown. See web or call for volume pricing.				0.195" dia.	13 dB/100ft
12"	24"	36"	48"	60"	72"	Custom Len.
\$48.86	\$54.94	\$61.02	\$67.45	\$73.65	\$79.85	See Web
RG174A/U Coax, 50 Ohm						
Part No. PE3291	1 piece price shown. See web or call for volume pricing.				0.110" dia.	32 dB/100ft
12"	24"	36"	48"	60"	72"	Custom Len.
\$50.00	\$50.58	\$48.94	\$51.76	\$52.36	\$52.95	See Web
RG178B/U Coax, 50 Ohm						
Part No. PE3321	1 piece price shown. See web or call for volume pricing.				0.072" dia.	44 dB/100ft
12"	24"	36"	48"	60"	72"	Custom Len.
\$71.84	\$72.90	\$73.96	\$70.66	\$71.61	\$77.24	See Web
RG188A/U Coax, 50 Ohm						
Part No. PE3911	1 piece price shown. See web or call for volume pricing.				0.110" dia.	32 dB/100ft
12"	24"	36"	48"	60"	72"	Custom Len.
\$50.78	\$57.33	\$55.22	\$57.44	\$59.66	\$61.88	See Web
RG214/U Coax, 50 Ohm						
Part No. PE3422	1 piece price shown. See web or call for volume pricing.				0.425" dia.	7 dB/100ft
12"	24"	36"	48"	60"	72"	Custom Len.
\$130.37	\$137.71	\$145.03	\$152.36	\$159.68	\$177.86	See Web
RG223/U Coax, 50 Ohm						
Part No. PE3519	1 piece price shown. See web or call for volume pricing.				0.210" dia.	13 dB/100ft
12"	24"	36"	48"	60"	72"	Custom Len.
\$44.65	\$47.76	\$50.88	\$54.17	\$57.34	\$60.52	See Web
RG316-DS Coax, 50 Ohm						
Part No. PE3957	1 piece price shown. See web or call for volume pricing.				0.114" dia.	9 dB/100ft
12"	24"	36"	48"	60"	72"	Custom Len.
\$42.70	\$45.51	\$48.42	\$51.34	\$55.45	\$58.64	See Web
RG393/U Coax, 50 Ohm						
Part No. PE3302	1 piece price shown. See web or call for volume pricing.				0.390" dia.	8 dB/100ft
12"	24"	36"	48"	60"	72"	Custom Len.
\$139.09	\$154.55	\$170.02	\$197.61	\$214.34	\$231.05	See Web
RG400/U Coax, 50 Ohm						
Part No. PE3614	1 piece price shown. See web or call for volume pricing.				0.195" dia.	15 dB/100ft
12"	24"	36"	48"	60"	72"	Custom Len.
\$58.24	\$65.63	\$73.03	\$80.85	\$88.40	\$95.93	See Web
PE-P141 Coax, 50 Ohm						
Part No. PE304	1 piece price shown. See web or call for volume pricing.				0.163" dia.	dB/100ft
12"	24"	36"	48"	60"	72"	Custom Len.
\$154.90	\$170.91	\$182.26	\$198.26	\$205.85	\$217.43	See Web
PE-P195 Coax, 50 Ohm						
Part No. PE3318	1 piece price shown. See web or call for volume pricing.				0.195" dia.	13 dB/100ft
12"	24"	36"	48"	60"	72"	Custom Len.
\$56.21	\$68.03	\$77.61	\$87.75	\$97.51	\$100.47	See Web
LMR-240-DB Coax, 50 Ohm						
Part No. PE3C3354	1 piece price shown. See web or call for volume pricing.				0.240" dia.	8 dB/100ft
12"	24"	36"	48"	60"	39.37"	Custom Len.
\$38.40	\$39.51	\$40.62	\$41.74	\$42.85	Call	See Web

Standard Semi-Rigid Cable Assemblies

Part No.	Cable Dia.				Attn. @ 1 GHz	Power @ 1 GHz
Part No. PE34257	1 piece price shown. See web or call for volume pricing.				* dia.	40 dB/100ft
6"	12"	18"	24"	36"	48"	Custom Len.
\$85.54	\$90.52	\$95.52	\$100.43	\$118.08	\$120.30	See Web
PE-SR402AL Coax, 50 Ohm						
Part No. PE34265	1 piece price shown. See web or call for volume pricing.				0.141" dia.	13 dB/100ft
6"	12"	18"	24"	36"	48"	Custom Len.
\$69.62	\$73.80	\$78.89	\$79.04	\$88.45	\$97.85	See Web
PE-SR405AL Coax, 50 Ohm						
Part No. PE34270	1 piece price shown. See web or call for volume pricing.				* dia.	23 dB/100ft
6"	12"	18"	24"	36"	48"	Custom Len.
\$80.20	\$80.20	\$84.51	\$88.83	\$97.48	\$106.11	See Web
RG401/U Coax, 50 Ohm						
Part No. PE33001	1 piece price shown. See web or call for volume pricing.				* dia.	8 dB/100ft
6"	12"	18"	24"	36"	48"	Custom Len.
\$135.42	\$138.14	\$149.11	\$160.09	\$182.03	\$203.98	See Web
RG405/U Coax, 50 Ohm						
Part No. PE3828	1 piece price shown. See web or call for volume pricing.				* dia.	22 dB/100ft
6"	12"	18"	24"	36"	48"	Custom Len.
\$79.43	\$83.04	\$81.78	\$85.22	\$97.89	\$98.95	See Web

Cable Assemblies

See Our Website For Current Pricing & Real-Time Stock Availability!

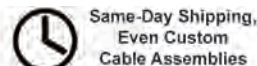
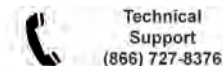

For Custom Lengths, Metric Lengths or Special Configurations, Please call (949) 261-1920



For our complete selection of cable assemblies, please visit our website

Cable Assemblies

See Our Website For Current Pricing & Real-Time Stock Availability!

PE-SR401AL-STRAIGHT Coax, 50 Ohm				
Part No. PE34259	Cable Dia.	Attn. @ 1 GHz	Power @ 1 GHz	
1 piece price shown. See web or call for volume pricing.				
6"	12"	18"	24"	36"
\$117.83	\$134.26	\$146.06	\$157.87	\$161.82
Standard Flexible Cable Assemblies				
RG55B/U Coax, 53 Ohm				
Part No. PE3654	Cable Dia.	Attn. @ 1 GHz	Power @ 1 GHz	
1 piece price shown. See web or call for volume pricing.				
12"	24"	36"	48"	60"
\$44.23	\$46.47	\$52.06	\$50.95	\$53.20
SMA MALE TO N MALE RIGHT ANGLE 				
Low Loss Flexible Cable Assemblies				
PE-P142LL Coax, 50 Ohm				
Part No. PE3C1037	Cable Dia.	Attn. @ 1 GHz	Power @ 1 GHz	
1 piece price shown. See web or call for volume pricing.				
12"	24"	36"	48"	60"
\$225.01	\$241.25	\$257.47	\$273.71	\$289.95
PE-P142LL-27478 Coax, 50 Ohm				
Part No. PE3M0134	Cable Dia.	Attn. @ 1 GHz	Power @ 1 GHz	
1 piece price shown. See web or call for volume pricing.				
12"	18"	24"	36"	48"
\$473.95	\$482.43	\$490.91	\$507.86	\$524.82
PE-P160LL-27478 Coax, 50 Ohm				
Part No. PE3M0188	Cable Dia.	Attn. @ 1 GHz	Power @ 1 GHz	
1 piece price shown. See web or call for volume pricing.				
8"	12"	18"	24"	30"
\$438.69	\$443.59	\$450.94	\$458.29	\$465.64
PE-P300LL-27478 Coax, 50 Ohm				
Part No. PE3M0231	Cable Dia.	Attn. @ 1 GHz	Power @ 1 GHz	
1 piece price shown. See web or call for volume pricing.				
12"	18"	24"	36"	48"
\$550.36	\$564.51	\$578.66	\$606.96	\$635.27
Low Loss Test Flexible Cable Assemblies				
PE-P300LL Coax, 50 Ohm				
Part No. PE3C3236	Cable Dia.	Attn. @ 1 GHz	Power @ 1 GHz	
1 piece price shown. See web or call for volume pricing.				
12"	24"	36"	48"	60"
\$233.15	\$258.34	\$283.51	\$308.70	\$333.88
Standard Formable Cable Assemblies				
PE-SR402FL Coax, 50 Ohm				
Part No. PE3W00507	Cable Dia.	Attn. @ 1 GHz	Power @ 1 GHz	
1 piece price shown. See web or call for volume pricing.				
12"	24"	36"	48"	60"
\$60.94	\$68.78	\$76.63	\$84.47	\$92.32
PE-SR402FLJ Coax, 50 Ohm				
Part No. PE3W00504	Cable Dia.	Attn. @ 1 GHz	Power @ 1 GHz	
1 piece price shown. See web or call for volume pricing.				
12"	24"	36"	48"	60"
\$60.16	\$68.23	\$76.30	\$84.38	\$92.45
Standard Flexible Cable Assemblies				
RG58C/U Coax, 50 Ohm				
Part No. PE3076	Cable Dia.	Attn. @ 1 GHz	Power @ 1 GHz	
1 piece price shown. See web or call for volume pricing.				
12"	24"	36"	48"	60"
\$62.28	\$63.10	\$63.91	\$64.77	\$65.60
SMA MALE TO N FEMALE 				
Low Loss Test Flexible Cable Assemblies				
PE-P300LL Coax, 50 Ohm				
Part No. PE3C3237	Cable Dia.	Attn. @ 1 GHz	Power @ 1 GHz	
1 piece price shown. See web or call for volume pricing.				
12"	24"	36"	48"	60"
\$217.87	\$243.04	\$268.23	\$293.41	\$318.59
PE-P300LL Coax, 50 Ohm				
Part No. PE3C3252	Cable Dia.	Attn. @ 1 GHz	Power @ 1 GHz	
1 piece price shown. See web or call for volume pricing.				
12"	24"	36"	48"	60"
\$236.31	\$261.52	\$286.72	\$311.93	\$337.12
SMA MALE TO N FEMALE BULKHEAD 				
SEE MOUNTING HOLE SECTION ON PAGE 369				
Precision Formable Cable Assemblies				
PE-SR402FL Coax, 50 Ohm				

Part No. PE39455					Cable Dia.	Attn. @ 1 GHz	Power @ 1 GHz
1 piece price shown. See web or call for volume pricing.							
6"	9"	12"	18"	24"	* dia.	12 dB/100ft	450 W
\$65.56	\$59.60	\$65.56	\$69.74	\$73.91	-	-	Custom Len.
PE-SR402FLJ Coax, 50 Ohm							
Part No. PE39469					Cable Dia.	Attn. @ 1 GHz	Power @ 1 GHz
1 piece price shown. See web or call for volume pricing.							
6"	9"	12"	18"	24"	0.161" dia.	12 dB/100ft	450 W
\$53.80	\$49.81	\$53.80	\$58.29	\$62.78	-	-	Custom Len.
PE-SR405FL Coax, 50 Ohm							
Part No. PE39447					Cable Dia.	Attn. @ 1 GHz	Power @ 1 GHz
1 piece price shown. See web or call for volume pricing.							
6"	9"	12"	18"	24"	* dia.	23 dB/100ft	130 W
\$26.56	\$46.07	\$26.56	\$32.20	\$37.84	-	-	Custom Len.
PE-SR405FLJ Coax, 50 Ohm							
Part No. PE39461					Cable Dia.	Attn. @ 1 GHz	Power @ 1 GHz
1 piece price shown. See web or call for volume pricing.							
6"	9"	12"	18"	24"	0.098" dia.	20 dB/100ft	130 W
\$51.44	\$51.44	\$51.44	\$55.62	\$59.79	-	-	Custom Len.
Low Loss Flexible Cable Assemblies							
PE-P142LL Coax, 50 Ohm							
Part No. PE3C2162					Cable Dia.	Attn. @ 1 GHz	Power @ 1 GHz
1 piece price shown. See web or call for volume pricing.							
12"	24"	36"	48"	60"	0.195" dia.	10 dB/100ft	W
\$179.72	\$195.96	\$212.18	\$228.42	\$244.66	50CM	Custom Len.	\$190.12
PE-P142LL-27478 Coax, 50 Ohm							
Part No. PE3M0133					Cable Dia.	Attn. @ 1 GHz	Power @ 1 GHz
1 piece price shown. See web or call for volume pricing.							
12"	18"	24"	36"	48"	0.195" dia.	dB/100ft	W
\$446.13	\$454.60	\$463.08	\$480.04	\$497.00	60"	Custom Len.	\$513.95
PE-P160LL-27478 Coax, 50 Ohm							
Part No. PE3M0187					Cable Dia.	Attn. @ 1 GHz	Power @ 1 GHz
1 piece price shown. See web or call for volume pricing.							
8"	12"	18"	24"	30"	0.160" dia.	dB/100ft	W
\$442.62	\$447.52	\$454.87	\$462.22	\$469.58	36"	Custom Len.	\$476.92
PE-P300LL-27478 Coax, 50 Ohm							
Part No. PE3M0230					Cable Dia.	Attn. @ 1 GHz	Power @ 1 GHz
1 piece price shown. See web or call for volume pricing.							
12"	18"	24"	36"	48"	0.300" dia.	dB/100ft	W
\$481.10	\$495.25	\$509.40	\$537.70	\$566.01	60"	Custom Len.	\$594.31
Low Loss Test Flexible Cable Assemblies							
PE-P300LL Coax, 50 Ohm							
Part No. PE3C3246					Cable Dia.	Attn. @ 1 GHz	Power @ 1 GHz
1 piece price shown. See web or call for volume pricing.							
12"	24"	36"	48"	60"	0.300" dia.	6 dB/100ft	W
\$294.09	\$319.30	\$344.50	\$369.71	\$394.90	50CM	Custom Len.	\$310.24
Standard Formable Cable Assemblies							
PE-SR402FL Coax, 50 Ohm							
Part No. PE33996					Cable Dia.	Attn. @ 1 GHz	Power @ 1 GHz
1 piece price shown. See web or call for volume pricing.							
6"	12"	18"	24"	36"	* dia.	12 dB/100ft	450 W
\$80.15	\$80.15	\$84.33	\$88.50	\$96.86	48"	Custom Len.	\$105.21
PE-SR405FL Coax, 50 Ohm							
Part No. PE33844					Cable Dia.	Attn. @ 1 GHz	Power @ 1 GHz
1 piece price shown. See web or call for volume pricing.							
6"	12"	18"	24"	36"	* dia.	23 dB/100ft	130 W
\$81.30	\$81.89	\$87.24	\$92.60	\$103.28	48"	Custom Len.	\$113.98
Standard Flexible Cable Assemblies							
RG58C/U Coax, 50 Ohm							
Part No. PE3013					Cable Dia.	Attn. @ 1 GHz	Power @ 1 GHz
1 piece price shown. See web or call for volume pricing.							
6"	12"	18"	24"	36"	0.195" dia.	20 dB/100ft	44 W
\$57.55	\$59.86	\$57.91	\$60.67	\$61.48	48"	Custom Len.	\$62.34
RG142B/U Coax, 50 Ohm							
Part No. PE3345					Cable Dia.	Attn. @ 1 GHz	Power @ 1 GHz
1 piece price shown. See web or call for volume pricing.							
6"	12"	18"	24"	36"	0.195" dia.	13 dB/100ft	650 W
\$51.50	\$51.37	\$57.49	\$60.53	\$66.61	48"	Custom Len.	\$73.04
RG174A/U Coax, 50 Ohm							
Part No. PE34171					Cable Dia.	Attn. @ 1 GHz	Power @ 1 GHz
1 piece price shown. See web or call for volume pricing.							
6"	12"	18"	24"	36"	0.100" dia.	32 dB/100ft	16 W
\$64.99	\$65.27	\$60.66	\$60.88	\$61.30	48"	Custom Len.	\$61.74
RG178B/U Coax, 50 Ohm							
Part No. PE34174					Cable Dia.	Attn. @ 1 GHz	Power @ 1 GHz
1 piece price shown. See web or call for volume pricing.							
6"	12"	18"	24"	36"	0.072" dia.	44 dB/100ft	78 W
\$63.83	\$64.29	\$64.78	\$65.27	\$66.22	48"	Custom Len.	\$67.17
RG188A/U Coax, 50 Ohm							
Part No. PE34176					Cable Dia.	Attn. @ 1 GHz	Power @ 1 GHz
1 piece price shown. See web or call for volume pricing.							
6"	12"	18"	24"	36"	0.110" dia.	26 dB/100ft	160 W
\$56.63	\$57.71	\$58.71	\$59.79	\$61.96	48"	Custom Len.	\$64.06

*Coax Performance at 1 GHz Notes: Cable assembly max frequency may be lower than connector or coax max frequency

For our complete selection of cable assemblies, please visit our website

RG214/U Coax, 50 Ohm				
Part No. PE33481	Cable Dia. Attn. @ 1 GHz Power @ 1 GHz			
1 piece price shown. See web or call for volume pricing.				
6"	12"	18"	24"	36"
\$126.56	\$126.56	\$138.04	\$133.90	\$141.22
				48"
				Custom Len.
				See Web
RG223/U Coax, 50 Ohm				
Part No. PE3193	Cable Dia. Attn. @ 1 GHz Power @ 1 GHz			
1 piece price shown. See web or call for volume pricing.				
6"	12"	18"	24"	36"
\$51.92	\$53.44	\$50.93	\$52.39	\$55.29
				48"
				Custom Len.
				See Web
RG316/U Coax, 50 Ohm				
Part No. PE33555	Cable Dia. Attn. @ 1 GHz Power @ 1 GHz			
1 piece price shown. See web or call for volume pricing.				
6"	12"	18"	24"	36"
\$65.50	\$67.02	\$63.49	\$64.94	\$73.26
				48"
				Custom Len.
				See Web
RG316-DS Coax, 50 Ohm				
Part No. PE33929	Cable Dia. Attn. @ 1 GHz Power @ 1 GHz			
1 piece price shown. See web or call for volume pricing.				
6"	12"	18"	24"	36"
\$59.87	\$64.66	\$61.32	\$67.78	\$70.90
				48"
				Custom Len.
				See Web
RG400/U Coax, 50 Ohm				
Part No. PE33117	Cable Dia. Attn. @ 1 GHz Power @ 1 GHz			
1 piece price shown. See web or call for volume pricing.				
6"	12"	18"	24"	36"
\$59.24	\$62.80	\$62.73	\$70.19	\$77.59
				48"
				Custom Len.
				See Web
PE-P195 Coax, 50 Ohm				
Part No. PE34178	Cable Dia. Attn. @ 1 GHz Power @ 1 GHz			
1 piece price shown. See web or call for volume pricing.				
6"	12"	18"	24"	36"
\$63.14	\$67.78	\$67.18	\$71.61	\$80.47
				48"
				Custom Len.
				See Web
Standard Semi-Rigid Cable Assemblies				
PE-SR402AL Coax, 50 Ohm				
Part No. PE34143	Cable Dia. Attn. @ 1 GHz Power @ 1 GHz			
1 piece price shown. See web or call for volume pricing.				
6"	12"	18"	24"	36"
\$78.85	\$83.78	\$88.88	\$93.97	\$97.86
				48"
				Custom Len.
				See Web
PE-SR405AL Coax, 50 Ohm				
Part No. PE34155	Cable Dia. Attn. @ 1 GHz Power @ 1 GHz			
1 piece price shown. See web or call for volume pricing.				
6"	12"	18"	24"	36"
\$78.22	\$78.22	\$82.55	\$86.86	\$105.06
				48"
				Custom Len.
				See Web
RG401/U Coax, 50 Ohm				
Part No. PE34157	Cable Dia. Attn. @ 1 GHz Power @ 1 GHz			
1 piece price shown. See web or call for volume pricing.				
6"	12"	18"	24"	36"
\$121.02	\$121.02	\$132.00	\$142.97	\$164.91
				48"
				Custom Len.
				See Web
RG402/U Coax, 50 Ohm				
Part No. PE3769	Cable Dia. Attn. @ 1 GHz Power @ 1 GHz			
1 piece price shown. See web or call for volume pricing.				
6"	12"	18"	24"	36"
\$76.88	\$81.49	\$80.53	\$84.18	\$91.48
				48"
				Custom Len.
				See Web
RG405/U Coax, 50 Ohm				
Part No. PE3367	Cable Dia. Attn. @ 1 GHz Power @ 1 GHz			
1 piece price shown. See web or call for volume pricing.				
6"	12"	18"	24"	36"
\$68.74	\$72.10	\$75.40	\$78.70	\$85.36
				48"
				Custom Len.
				See Web
Standard Flexible Cable Assemblies				
RG55B/U Coax, 53 Ohm				
Part No. PE34169	Cable Dia. Attn. @ 1 GHz Power @ 1 GHz			
1 piece price shown. See web or call for volume pricing.				
6"	12"	18"	24"	36"
\$48.65	\$48.65	\$49.78	\$50.89	\$53.13
				48"
				Custom Len.
				See Web
SMA MALE TO QMA MALE				
Low Loss Flexible Cable Assemblies				
PE-C195 Coax, 50 Ohm				
Part No. PE38116	Cable Dia. Attn. @ 1 GHz Power @ 1 GHz			
1 piece price shown. See web or call for volume pricing.				
12"	24"	36"	48"	60"
\$44.69	\$49.04	\$46.11	\$46.83	\$47.54
				72"
				Custom Len.
				See Web
Standard Flexible Cable Assemblies				
RG58C/U Coax, 50 Ohm				
Part No. PE38275	Cable Dia. Attn. @ 1 GHz Power @ 1 GHz			
1 piece price shown. See web or call for volume pricing.				
12"	24"	36"	48"	60"
\$54.25	\$50.96	\$51.70	\$52.44	\$53.18
				72"
				Custom Len.
				See Web
RG316/U Coax, 50 Ohm				
Part No. PE38273	Cable Dia. Attn. @ 1 GHz Power @ 1 GHz			
1 piece price shown. See web or call for volume pricing.				
12"	24"	36"	48"	60"
\$53.72	\$56.60	\$59.49	\$66.50	\$65.27
				72"
				Custom Len.
				See Web

RG316-DS Coax, 50 Ohm				
Part No. PE38274	Cable Dia. Attn. @ 1 GHz Power @ 1 GHz			
1 piece price shown. See web or call for volume pricing.				
12"	24"	36"	48"	60"
\$72.18	\$71.01	\$73.91	\$76.83	\$79.74
				72"
				Custom Len.
				See Web
SMA MALE TO SMA MALE				
Flexible Cable Assemblies				
LMR-100A-PVC Coax, 50 Ohm				
Part No. PE3C0113	Cable Dia. Attn. @ 1 GHz Power @ 1 GHz			
1 piece price shown. See web or call for volume pricing.				
12"	24"	36"	48"	60"
\$43.92	\$44.68	\$45.44	\$46.24	\$47.01
				72"
				Custom Len.
				See Web
LMR-195 Coax, 50 Ohm				
Part No. PE3C0038	Cable Dia. Attn. @ 1 GHz Power @ 1 GHz			
1 piece price shown. See web or call for volume pricing.				
12"	24"	36"	48"	60"
\$36.04	\$36.80	\$37.55	\$38.34	\$39.10
				72"
				Custom Len.
				See Web
PE-P160LL Coax, 50 Ohm				
Part No. PE3C5241	Cable Dia. Attn. @ 1 GHz Power @ 1 GHz			
1 piece price shown. See web or call for volume pricing.				
12"	24"	36"	48"	60"
\$205.44	\$226.16	\$246.87	\$267.58	\$288.29
				72"
				Custom Len.
				See Web
Semi-Rigid Cable Assemblies				
PE-SR402AL Coax, 50 Ohm				
Part No. PE3C1398	Cable Dia. Attn. @ 1 GHz Power @ 1 GHz			
1 piece price shown. See web or call for volume pricing.				
12"	24"	36"	48"	60"
\$48.78	\$58.81	\$63.83	\$73.86	\$83.89
				72"
				Custom Len.
				See Web
Precision Formable Cable Assemblies				
PE-80TEST Coax, 50 Ohm				
Part No. PE3TC0101	Cable Dia. Attn. @ 1 GHz Power @ 1 GHz			
1 piece price shown. See web or call for volume pricing.				
24"	48"	72"	-	-
\$313.54	\$399.28	\$485.03	-	-
				Custom Len.
				See Web
Part No. PE3TC0201	Cable Dia. Attn. @ 1 GHz Power @ 1 GHz			
1 piece price shown. See web or call for volume pricing.				
24"	48"	72"	-	-
\$454.28	\$540.02	\$625.77	-	-
				Custom Len.
				See Web
PE-90TEST Coax, 50 Ohm				
Part No. PE3TC0301	Cable Dia. Attn. @ 1 GHz Power @ 1 GHz			
1 piece price shown. See web or call for volume pricing.				
24"	48"	72"	-	-
\$230.61	\$328.04	\$405.99	-	-
				Custom Len.
				See Web
Part No. PE3TC0401	Cable Dia. Attn. @ 1 GHz Power @ 1 GHz			
1 piece price shown. See web or call for volume pricing.				
24"	48"	72"	-	-
\$390.84	\$468.79	\$546.73	-	-
				Custom Len.
				See Web
Precision Flexible Cable Assemblies				
PE-P141 Coax, 50 Ohm				
Part No. PE3CA1130	Cable Dia. Attn. @ 1 GHz Power @ 1 GHz			
1 piece price shown. See web or call for volume pricing.				
12"	24"	36"	48"	60"
\$122.88	\$133.28	\$143.67	\$154.06	\$164.45
				72"
				Custom Len.
				See Web
Part No. PE312	Cable Dia. Attn. @ 1 GHz Power @ 1 GHz			
1 piece price shown. See web or call for volume pricing.				
12"	24"	36"	48"	60"
\$158.15	\$163.79	\$162.56	\$147.71	\$175.78
				72"
				Custom Len.
				See Web
Low Loss Flexible Cable Assemblies				
PE-C100-LSZH Coax, 50 Ohm				
Part No. PE37908	Cable Dia. Attn. @ 1 GHz Power @ 1 GHz			
1 piece price shown. See web or call for volume pricing.				
12"	24"	36"	48"	60"
\$48.61	\$49.93	\$51.26	\$52.67	\$54.02
				72"
				Custom Len.
				See Web
PE-C195 Coax, 50 Ohm				
Part No. PE35784	Cable Dia. Attn. @ 1 GHz Power @ 1 GHz			
1 piece price shown. See web or call for volume pricing.				
12"	24"	36"	48"	60"
\$39.53	\$40.32	\$41.10	\$41.92	\$42.72
				72"
				Custom Len.
				See Web
PE-C240 Coax, 50 Ohm				
Part No. PE38628	Cable Dia. Attn. @ 1 GHz Power @ 1 GHz			
1 piece price shown. See web or call for volume pricing.				
12"	24"	36"	48"	60"
\$51.03	\$55.22	\$54.70	\$57.46	\$60.27
				72"
				Custom Len.
				See Web
LMR-100A-PVC Coax, 50 Ohm				
Part No. PE3C0057	Cable Dia. Attn. @ 1 GHz Power @ 1 GHz			
1 piece price shown. See web or call for volume pricing.				
12"	24"	36"	48"	60"
\$47.50	\$48.26	\$49.02	\$49.82	\$50.60
				72"
				Custom Len.
				See Web
LMR-240 Coax, 50 Ohm				

Continued on Next Page

Cable Assemblies

See Our Website For Current Pricing & Real-Time Stock Availability!

For Custom Lengths, Metric Lengths or Special Configurations, Please call (949) 261-1920

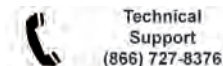

Technical Support
(866) 727-8376



Same-Day Shipping,
Even Custom
Cable Assemblies

For our complete selection of cable assemblies, please visit our website

Part No. PE3C0052	Cable Dia.	Attn. @ 1 GHz	Power @ 1 GHz
1 piece price shown. See web or call for volume pricing.	0.240" dia.	8 dB/100ft	W
12" 24" 36" 48"	60"	-	Custom Len.
\$50.55 \$51.51 \$52.49 \$53.52	\$54.52	-	See Web
Part No. PE3C0103	Cable Dia.	Attn. @ 1 GHz	Power @ 1 GHz
1 piece price shown. See web or call for volume pricing.	0.240" dia.	8 dB/100ft	W
12" 24" 36" 48"	60"	-	Custom Len.
\$38.19 \$39.17 \$40.15 \$41.18	\$42.16	-	See Web
LMR-400-DB Coax, 50 Ohm			
Part No. PE3W01582	Cable Dia.	Attn. @ 1 GHz	Power @ 1 GHz
1 piece price shown. See web or call for volume pricing.	0.405" dia.	4 dB/100ft	W
12" 24" 36" 48"	60"	50CM	Custom Len.
\$70.87 \$72.30 \$73.75 \$75.18	\$76.63	\$71.79	See Web
PE-P142LL Coax, 50 Ohm			
Part No. PE3C0230	Cable Dia.	Attn. @ 1 GHz	Power @ 1 GHz
1 piece price shown. See web or call for volume pricing.	0.320" dia.	7 dB/100ft	W
12" 24" 36" 48"	60"	72"	Custom Len.
\$264.59 \$282.95 \$352.36 \$357.63	\$379.43	\$418.18	See Web
PE-P142LL-27478 Coax, 50 Ohm			
Part No. PE3M0125	Cable Dia.	Attn. @ 1 GHz	Power @ 1 GHz
1 piece price shown. See web or call for volume pricing.	0.195" dia.	dB/100ft	W
12" 18" 24" 36"	48"	60"	Custom Len.
\$347.79 \$356.27 \$364.75 \$381.71	\$398.66	\$415.62	See Web
PE-P160LL-27478 Coax, 50 Ohm			
Part No. PE3M0180	Cable Dia.	Attn. @ 1 GHz	Power @ 1 GHz
1 piece price shown. See web or call for volume pricing.	0.160" dia.	dB/100ft	W
8" 12" 18" 24"	30"	36"	Custom Len.
\$340.63 \$345.53 \$352.89 \$360.23	\$367.59	\$374.93	See Web
PE-P300LL-27478 Coax, 50 Ohm			
Part No. PE3M0225	Cable Dia.	Attn. @ 1 GHz	Power @ 1 GHz
1 piece price shown. See web or call for volume pricing.	0.300" dia.	dB/100ft	W
12" 18" 24" 36"	48"	60"	Custom Len.
\$392.78 \$406.93 \$421.09 \$449.39	\$477.69	\$505.99	See Web
LMR-240-DB Coax, 50 Ohm			
Part No. PE3W03353	Cable Dia.	Attn. @ 1 GHz	Power @ 1 GHz
1 piece price shown. See web or call for volume pricing.	0.240" dia.	8 dB/100ft	W
12" 24" 36" 48"	60"	50CM	Custom Len.
\$51.53 \$52.65 \$53.75 \$54.85	\$55.96	\$52.24	See Web
Low PIM Formable Cable Assemblies			
PE-SR402FLJ Low PIM Coax, 50 Ohm			
Part No. PE3C2008	Cable Dia.	Attn. @ 1 GHz	Power @ 1 GHz
1 piece price shown. See web or call for volume pricing.	0.161" dia.	dB/100ft	W
100CM 200CM	-	-	Custom Len.
\$71.50 \$86.03	-	-	See Web
Low PIM Corrugated Cable Assemblies			
SPP-250-LLPL Coax, 50 Ohm			
Part No. PE3C6207	Cable Dia.	Attn. @ 1 GHz	Power @ 1 GHz
1 piece price shown. See web or call for volume pricing.	0.280" dia.	6 dB/100ft	650 W
12" 24" 36" 48"	60"	50CM	Custom Len.
\$42.83 \$48.41 \$53.99 \$59.57	\$65.15	\$46.39	See Web
Part No. PE3C5888	Cable Dia.	Attn. @ 1 GHz	Power @ 1 GHz
1 piece price shown. See web or call for volume pricing.	0.280" dia.	6 dB/100ft	650 W
12" 24" 36" 48"	60"	50CM	Custom Len.
\$57.35 \$62.93 \$68.51 \$74.09	\$79.67	\$60.93	See Web
Test Flexible Cable Assemblies			
PE-P160 Coax, 50 Ohm			
Part No. PE3366	Cable Dia.	Attn. @ 1 GHz	Power @ 1 GHz
1 piece price shown. See web or call for volume pricing.	0.160" dia.	13 dB/100ft	W
36" 48" 100CM 150CM	-	-	Custom Len.
\$325.89 \$351.04 \$332.96 \$374.21	-	-	See Web
Low Loss Test Flexible Cable Assemblies			
PE-P300LL Coax, 50 Ohm			
Part No. PE3C3235	Cable Dia.	Attn. @ 1 GHz	Power @ 1 GHz
1 piece price shown. See web or call for volume pricing.	0.300" dia.	6 dB/100ft	W
12" 24" 36" 48"	60"	50CM	Custom Len.
\$153.75 \$178.94 \$204.11 \$229.30	\$254.48	\$169.90	See Web
Part No. PE3333	Cable Dia.	Attn. @ 1 GHz	Power @ 1 GHz
1 piece price shown. See web or call for volume pricing.	0.300" dia.	5 dB/100ft	W
12" 24" 36" 48"	60"	50CM	Custom Len.
\$244.02 \$269.96 \$295.90 \$321.84	\$347.78	\$260.65	See Web
Part No. PE3369	Cable Dia.	Attn. @ 1 GHz	Power @ 1 GHz
1 piece price shown. See web or call for volume pricing.	0.300" dia.	dB/100ft	W
12" 24" 36" 48"	60"	72"	Custom Len.
\$235.75 \$261.69 \$287.63 \$318.95	\$339.50	\$376.99	See Web
PE-P142LL Coax, 50 Ohm			
Part No. PE341	Cable Dia.	Attn. @ 1 GHz	Power @ 1 GHz
1 piece price shown. See web or call for volume pricing.	0.195" dia.	7 dB/100ft	W
12" 24" 36" 48"	60"	50CM	Custom Len.
\$111.93 \$128.17 \$144.40 \$160.64	\$176.88	\$122.33	See Web
Standard Formable Cable Assemblies			
PE-SR047FL Coax, 50 Ohm			

Part No. PE34186	Cable Dia.	Attn. @ 1 GHz	Power @ 1 GHz
1 piece price shown. See web or call for volume pricing.	0.047" dia.	36 dB/100ft	32 W
6" 12" 18" 24"	36"	48"	Custom Len.
\$88.22 \$92.16 \$96.22 \$94.31	\$101.69	\$109.06	See Web
PE-SR401FL Coax, 50 Ohm			
Part No. PE34188	Cable Dia.	Attn. @ 1 GHz	Power @ 1 GHz
1 piece price shown. See web or call for volume pricing.	" dia.	7 dB/100ft	279 W
6" 12" 18" 24"	36"	48"	Custom Len.
\$121.29 \$129.22 \$137.39 \$145.55	\$177.48	\$192.89	See Web
PE-SR402FL Coax, 50 Ohm			
Part No. PE39423	Cable Dia.	Attn. @ 1 GHz	Power @ 1 GHz
1 piece price shown. See web or call for volume pricing.	" dia.	12 dB/100ft	400 W
3" 6" 9" 12"	18"	24"	Custom Len.
\$46.47 \$45.59 \$43.63 \$45.59	\$51.39	\$57.19	See Web
Part No. PE3481	Cable Dia.	Attn. @ 1 GHz	Power @ 1 GHz
1 piece price shown. See web or call for volume pricing.	" dia.	12 dB/100ft	400 W
6" 12" 18" 24"	36"	48"	Custom Len.
\$43.54 \$47.47 \$51.51 \$55.54	\$63.63	\$72.18	See Web
PE-SR402FLJ Coax, 50 Ohm			
Part No. PE39437	Cable Dia.	Attn. @ 1 GHz	Power @ 1 GHz
1 piece price shown. See web or call for volume pricing.	0.161" dia.	12 dB/100ft	303 W
6" 9" 12" 18"	24"	-	Custom Len.
\$57.75 \$55.73 \$57.75 \$62.24	\$66.72	-	See Web
PE-SR405FL Coax, 50 Ohm			
Part No. PE39415	Cable Dia.	Attn. @ 1 GHz	Power @ 1 GHz
1 piece price shown. See web or call for volume pricing.	" dia.	23 dB/100ft	105 W
6" 9" 12" 18"	24"	-	Custom Len.
\$50.03 \$48.15 \$50.03 \$55.61	\$61.19	-	See Web
Part No. PE3867	Cable Dia.	Attn. @ 1 GHz	Power @ 1 GHz
1 piece price shown. See web or call for volume pricing.	" dia.	23 dB/100ft	130 W
6" 12" 18" 24"	36"	48"	Custom Len.
\$50.50 \$56.00 \$61.68 \$67.35	\$74.22	\$84.92	See Web
PE-SR405FLJ Coax, 50 Ohm			
Part No. PE39429	Cable Dia.	Attn. @ 1 GHz	Power @ 1 GHz
1 piece price shown. See web or call for volume pricing.	0.105" dia.	20 dB/100ft	122 W
6" 9" 12" 18"	24"	-	Custom Len.
\$49.99 \$47.91 \$49.99 \$54.47	\$58.96	-	See Web
Standard Flexible Cable Assemblies			
RG8X Coax, 50 Ohm			
Part No. PE39087	Cable Dia.	Attn. @ 1 GHz	Power @ 1 GHz
1 piece price shown. See web or call for volume pricing.	0.242" dia.	14 dB/100ft	60 W
12" 24" 36" 48"	60"	-	Custom Len.
\$63.72 \$66.78 \$74.61 \$78.34	\$81.95	-	See Web
RG58C/U Coax, 50 Ohm			
Part No. PE3369	Cable Dia.	Attn. @ 1 GHz	Power @ 1 GHz
1 piece price shown. See web or call for volume pricing.	0.195" dia.	20 dB/100ft	44 W
6" 12" 18" 24"	36"	48"	Custom Len.
\$43.02 \$43.02 \$43.40 \$43.76	\$44.50	\$45.24	See Web
Part No. PE36689	Cable Dia.	Attn. @ 1 GHz	Power @ 1 GHz
1 piece price shown. See web or call for volume pricing.	0.195" dia.	20 dB/100ft	44 W
24" 36" 48"	-	-	Custom Len.
\$112.67 \$106.95 \$114.34	-	-	See Web
Part No. PE36690	Cable Dia.	Attn. @ 1 GHz	Power @ 1 GHz
1 piece price shown. See web or call for volume pricing.	0.195" dia.	20 dB/100ft	80 W
24" 36" 48" 72"	-	-	Custom Len.
\$171.20 \$171.98 \$172.68 \$174.13	-	-	See Web
RG142B/U Coax, 50 Ohm			
Part No. PE3385	Cable Dia.	Attn. @ 1 GHz	Power @ 1 GHz
1 piece price shown. See web or call for volume pricing.	0.195" dia.	13 dB/100ft	600 W
6" 12" 18" 24"	36"	48"	Custom Len.
\$49.68 \$52.64 \$55.67 \$58.71	\$64.79	\$71.22	See Web
RG174A/U Coax, 50 Ohm			
Part No. PE3353	Cable Dia.	Attn. @ 1 GHz	Power @ 1 GHz
1 piece price shown. See web or call for volume pricing.	0.100" dia.	32 dB/100ft	16 W
6" 12" 18" 24"	36"	48"	Custom Len.
\$48.71 \$48.99 \$49.28 \$49.57	\$50.14	\$50.76	See Web
Part No. PE3W00365	Cable Dia.	Attn. @ 1 GHz	Power @ 1 GHz
1 piece price shown. See web or call for volume pricing.	0.110" dia.	32 dB/100ft	W
12" 24" 36" 48"	60"	50CM	Custom Len.
\$62.89 \$63.45 \$64.01 \$64.57	\$61.56	\$59.67	See Web
RG178B/U Coax, 50 Ohm			
Part No. PE3574	Cable Dia.	Attn. @ 1 GHz	Power @ 1 GHz
1 piece price shown. See web or call for volume pricing.	0.072" dia.	44 dB/100ft	78 W
6" 12" 18" 24"	36"	48"	Custom Len.
\$65.47 \$65.98 \$66.51 \$67.04	\$68.10	\$69.22	See Web
RG188A/U Coax, 50 Ohm			
Part No. PE3361	Cable Dia.	Attn. @ 1 GHz	Power @ 1 GHz
1 piece price shown. See web or call for volume pricing.	0.110" dia.	26 dB/100ft	160 W
6" 12" 18" 24"	36"	48"	Custom Len.
\$49.40 \$50.61 \$51.86 \$53.10	\$55.60	\$58.24	See Web
RG188-DS Coax, 50 Ohm			
Part No. PE3778	Cable Dia.	Attn. @ 1 GHz	Power @ 1 GHz
1 piece price shown. See web or call for volume pricing.	0.122" dia.	30 dB/100ft	160 W
12" 24" 36" 48"	60"	-	Custom Len.
\$54.39 \$54.71 \$61.44 \$61.52	\$68.75	-	See Web

*Coax Performance at 1 GHz Notes: Cable assembly max frequency may be lower than connector or coax max frequency

Cable Assemblies See Our Website For Current Pricing & Real-Time Stock Availability!

For our complete selection of cable assemblies, please visit our website

RG213/U Coax, 50 Ohm						
Part No. PE35571	Cable Dia.			Attn. @ 1 GHz	Power @ 1 GHz	
1 piece price shown. See web or call for volume pricing.						
12"	24"	36"	48"	60"	-	Custom Len.
\$170.04	\$171.55	\$172.99	\$174.48	\$176.00	-	See Web
RG214/U Coax, 50 Ohm						
Part No. PE3121	Cable Dia.			Attn. @ 1 GHz	Power @ 1 GHz	
1 piece price shown. See web or call for volume pricing.						
6"	12"	18"	24"	36"	48"	Custom Len.
\$197.63	\$197.63	\$201.29	\$204.95	\$212.28	\$219.60	See Web
RG223/U Coax, 50 Ohm						
Part No. PE3377	Cable Dia.			Attn. @ 1 GHz	Power @ 1 GHz	
1 piece price shown. See web or call for volume pricing.						
6"	12"	18"	24"	36"	48"	Custom Len.
\$38.53	\$38.53	\$39.98	\$41.42	\$44.32	\$47.22	See Web
Part No. PE3W02458	Cable Dia.			Attn. @ 1 GHz	Power @ 1 GHz	
1 piece price shown. See web or call for volume pricing.						
12"	24"	36"	48"	60"	50CM	Custom Len.
\$59.34	\$73.41	\$76.65	\$79.89	\$83.13	\$72.23	See Web
RG316/U Coax, 50 Ohm						
Part No. PE3573	Cable Dia.			Attn. @ 1 GHz	Power @ 1 GHz	
1 piece price shown. See web or call for volume pricing.						
6"	12"	18"	24"	36"	48"	Custom Len.
\$49.04	\$50.56	\$52.13	\$53.69	\$56.81	\$60.12	See Web
RG316-DS Coax, 50 Ohm						
Part No. PE3704	Cable Dia.			Attn. @ 1 GHz	Power @ 1 GHz	
1 piece price shown. See web or call for volume pricing.						
12"	24"	36"	48"	60"	-	Custom Len.
\$49.41	\$52.54	\$55.67	\$58.97	\$62.16	-	See Web
RG400/U Coax, 50 Ohm						
Part No. PE3500	Cable Dia.			Attn. @ 1 GHz	Power @ 1 GHz	
1 piece price shown. See web or call for volume pricing.						
6"	12"	18"	24"	36"	48"	Custom Len.
\$51.73	\$55.32	\$59.02	\$62.71	\$70.11	\$77.94	See Web
PE-P086EAM Coax, 50 Ohm						
Part No. PE3CA1039	Cable Dia.			Attn. @ 1 GHz	Power @ 1 GHz	
1 piece price shown. See web or call for volume pricing.						
12"	24"	36"	50CM	100CM	-	Custom Len.
\$57.97	\$70.84	\$84.45	\$75.45	\$99.64	-	See Web
PE-P141 Coax, 50 Ohm						
Part No. PE300	Cable Dia.			Attn. @ 1 GHz	Power @ 1 GHz	
1 piece price shown. See web or call for volume pricing.						
12"	24"	36"	48"	60"	72"	Custom Len.
\$114.89	\$129.70	\$141.04	\$147.01	\$164.64	\$176.21	See Web
Part No. PE350	Cable Dia.			Attn. @ 1 GHz	Power @ 1 GHz	
1 piece price shown. See web or call for volume pricing.						
12"	24"	36"	48"	60"	72"	Custom Len.
\$90.63	\$101.02	\$116.06	\$128.08	\$132.20	\$151.23	See Web
PE-P195 Coax, 50 Ohm						
Part No. PE3138	Cable Dia.			Attn. @ 1 GHz	Power @ 1 GHz	
1 piece price shown. See web or call for volume pricing.						
6"	12"	18"	24"	36"	48"	Custom Len.
\$65.16	\$69.80	\$74.59	\$79.38	\$88.96	\$99.10	See Web
PE-P141FLX Coax, 50 Ohm						
Part No. PE3CA1035	Cable Dia.			Attn. @ 1 GHz	Power @ 1 GHz	
1 piece price shown. See web or call for volume pricing.						
50CM	12"	24"	36"	100CM	-	Custom Len.
\$77.53	\$68.25	\$89.64	\$110.41	\$115.19	-	See Web
PE-VNA-R Coax, 50 Ohm						
Part No. PE3VNA1801	Cable Dia.			Attn. @ 1 GHz	Power @ 1 GHz	
1 piece price shown. See web or call for volume pricing.						
24"	48"	-	-	-	-	Custom Len.
\$776.91	\$866.24	-	-	-	-	See Web
Standard Semi-Rigid Cable Assemblies						
PE-020SR Coax, 50 Ohm						
Part No. PE34191	Cable Dia.			Attn. @ 1 GHz	Power @ 1 GHz	
1 piece price shown. See web or call for volume pricing.						
6"	12"	18"	24"	36"	48"	Custom Len.
\$134.44	\$143.87	\$153.58	\$163.29	\$172.02	\$190.16	See Web
PE-034SR Coax, 50 Ohm						
Part No. PE34193	Cable Dia.			Attn. @ 1 GHz	Power @ 1 GHz	
1 piece price shown. See web or call for volume pricing.						
6"	12"	18"	24"	36"	48"	Custom Len.
\$138.59	\$136.38	\$142.50	\$156.86	\$169.16	\$173.24	See Web
PE-047SR Coax, 50 Ohm						
Part No. PE3656	Cable Dia.			Attn. @ 1 GHz	Power @ 1 GHz	
1 piece price shown. See web or call for volume pricing.						
6"	12"	18"	24"	36"	48"	Custom Len.
\$87.73	\$93.53	\$99.49	\$105.46	\$109.91	\$130.02	See Web
PE-SR047AL Coax, 50 Ohm						
Part No. PE3387	Cable Dia.			Attn. @ 1 GHz	Power @ 1 GHz	
1 piece price shown. See web or call for volume pricing.						
6"	12"	18"	24"	36"	48"	Custom Len.
\$89.09	\$94.03	\$93.24	\$97.79	\$114.38	\$115.94	See Web

PE-SR402AL Coax, 50 Ohm						
Part No. PE34180	Cable Dia.			Attn. @ 1 GHz	Power @ 1 GHz	
1 piece price shown. See web or call for volume pricing.						
6"	12"	18"	24"	36"	48"	Custom Len.
\$51.17	\$56.12	\$61.20	\$66.29	\$76.47	\$87.23	See Web
PE-SR402TN Coax, 50 Ohm						
Part No. PE3C1015	Cable Dia.			Attn. @ 1 GHz	Power @ 1 GHz	
1 piece price shown. See web or call for volume pricing.						
12"	24"	36"	48"	60"	72"	Custom Len.
\$49.99	\$56.94	\$56.95	\$62.28	\$67.62	\$72.94	See Web
PE-SR405AL Coax, 50 Ohm						
Part No. PE34182	Cable Dia.			Attn. @ 1 GHz	Power @ 1 GHz	
1 piece price shown. See web or call for volume pricing.						
6"	12"	18"	24"	36"	48"	Custom Len.
\$48.07	\$52.69	\$57.45	\$62.20	\$71.71	\$76.60	See Web
RG401/U Coax, 50 Ohm						
Part No. PE33003	Cable Dia.			Attn. @ 1 GHz	Power @ 1 GHz	
1 piece price shown. See web or call for volume pricing.						
6"	12"	18"	24"	36"	48"	Custom Len.
\$133.86	\$144.87	\$156.20	\$158.61	\$190.20	\$214.19	See Web
RG402/U Coax, 50 Ohm						
Part No. PE3492	Cable Dia.			Attn. @ 1 GHz	Power @ 1 GHz	
1 piece price shown. See web or call for volume pricing.						
6"	12"	18"	24"	36"	48"	Custom Len.
\$49.55	\$53.34	\$57.26	\$61.17	\$68.99	\$77.27	See Web
RG405/U Coax, 50 Ohm						
Part No. PE3818	Cable Dia.			Attn. @ 1 GHz	Power @ 1 GHz	
1 piece price shown. See web or call for volume pricing.						
6"	12"	18"	24"	36"	48"	Custom Len.
\$47.24	\$50.85	\$54.56	\$58.28	\$65.71	\$73.56	See Web
PE-SR401AL-STRAIGHT Coax, 50 Ohm						
Part No. PE34184	Cable Dia.			Attn. @ 1 GHz	Power @ 1 GHz	
1 piece price shown. See web or call for volume pricing.						
6"	12"	18"	24"	36"	48"	Custom Len.
\$132.80	\$140.77	\$141.88	\$150.95	\$169.08	\$187.23	See Web
Standard Flexible Cable Assemblies						
RG55B/U Coax, 53 Ohm						
Part No. PE3572	Cable Dia.			Attn. @ 1 GHz	Power @ 1 GHz	
1 piece price shown. See web or call for volume pricing.						
6"	12"	18"	24"	36"	48"	Custom Len.
\$42.20	\$44.74	\$43.33	\$47.33	\$46.69	\$48.93	See Web
RG59B/U Coax, 75 Ohm						
Part No. PE3814	Cable Dia.			Attn. @ 1 GHz	Power @ 1 GHz	
1 piece price shown. See web or call for volume pricing.						
6"	12"	18"	24"	36"	48"	Custom Len.
\$67.25	\$71.29	\$67.73	\$68.22	\$69.18	\$70.14	See Web
RG179B/U Coax, 75 Ohm						
Part No. PE3739	Cable Dia.			Attn. @ 1 GHz	Power @ 1 GHz	
1 piece price shown. See web or call for volume pricing.						
6"	12"	18"	24"	36"	48"	Custom Len.
\$46.76	\$47.99	\$49.28	\$50.56	\$53.11	\$52.38	See Web
RG187A/U Coax, 75 Ohm						
Part No. PE38059	Cable Dia.			Attn. @ 1 GHz	Power @ 1 GHz	
1 piece price shown. See web or call for volume pricing.						
12"	24"	36"	48"	60"	-	Custom Len.
\$48.45	\$55.17	\$54.76	\$57.87	\$60.99	-	See Web
RG62A/U Coax, 93 Ohm						
Part No. PE3899	Cable Dia.			Attn. @ 1 GHz	Power @ 1 GHz	
1 piece price shown. See web or call for volume pricing.						
6"	12"	18"	24"	36"	48"	Custom Len.
\$67.72	\$67.72	\$68.41	\$69.09	\$70.46	\$71.84	See Web
RG180B/U Coax, 95 Ohm						
Part No. PE3245	Cable Dia.			Attn. @ 1 GHz	Power @ 1 GHz	
1 piece price shown. See web or call for volume pricing.						
12"	24"	36"	48"	60"	-	Custom Len.
\$63.63	\$64.02	\$68.01	\$76.84	\$81.25	-	See Web
SMA MALE TO SMA MALE RIGHT ANGLE						
Precision Flexible Cable Assemblies						
PE-P141 Coax, 50 Ohm						
Part No. PE351	Cable Dia.			Attn. @ 1 GHz	Power @ 1 GHz	
1 piece price shown. See web or call for volume pricing.						
6"	12"	24"	36"	48"	60"	Custom Len.
\$164.93	\$170.45	\$174.60	\$193.16	\$205.17	\$216.75	See Web
Part No. PE3C0806	Cable Dia.			Attn. @ 1 GHz	Power @ 1 GHz	
1 piece price shown. See web or call for volume pricing.						
12"	24"	36"	48"	60"	72"	Custom Len.
\$140.27	\$151.57	\$162.88	\$174.20	\$185.50	\$196.81	See Web
Low Loss Flexible Cable Assemblies						
PE-C195 Coax, 50 Ohm						

Cable Assemblies

See Our Website For Current Pricing & Real-Time Stock Availability!

Continued on Next Page

For Custom Lengths, Metric Lengths or Special Configurations, Please call (949) 261-1920

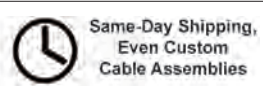

For our complete selection of cable assemblies, please visit our website

Part No.	Cable Dia.				Attn. @ 1 GHz	Power @ 1 GHz
Part No. PE36475	0.195" dia.				11 dB/100ft	150 W
1 piece price shown. See web or call for volume pricing.	12"	24"	36"	48"	60"	Custom Len.
	\$46.37	\$47.15	\$44.37	\$45.07	\$45.79	See Web
PE-C240 Coax, 50 Ohm						
Part No. PE38624	0.240" dia.				9 dB/100ft	250 W
1 piece price shown. See web or call for volume pricing.	12"	24"	36"	48"	60"	Custom Len.
	\$66.53	\$67.67	\$64.83	\$67.61	\$70.43	See Web
LMR-240 Coax, 50 Ohm						
Part No. PE3C0104	0.240" dia.				8 dB/100ft	W
1 piece price shown. See web or call for volume pricing.	12"	24"	36"	48"	60"	Custom Len.
	\$42.20	\$41.55	\$42.52	\$45.19	\$46.17	See Web
PE-P142LL-27478 Coax, 50 Ohm						
Part No. PE3M0128	0.195" dia.				48" dB/100ft	W
1 piece price shown. See web or call for volume pricing.	12"	18"	24"	36"	60"	Custom Len.
	\$447.98	\$456.45	\$464.93	\$481.89	\$498.84	\$515.80
PE-P160LL-27478 Coax, 50 Ohm						
Part No. PE3M0182	0.160" dia.				36" dB/100ft	W
1 piece price shown. See web or call for volume pricing.	8"	12"	18"	24"	30"	36"
	\$446.55	\$451.46	\$458.81	\$466.16	\$473.51	\$480.86
PE-P300LL-27478 Coax, 50 Ohm						
Part No. PE3M0226	0.300" dia.				48" dB/100ft	W
1 piece price shown. See web or call for volume pricing.	12"	18"	24"	36"	60"	Custom Len.
	\$517.63	\$531.78	\$545.93	\$574.23	\$602.54	\$630.84
PE-P160LL Coax, 50 Ohm						
Part No. PE3C5246	0.160" dia.				48" dB/100ft	W
1 piece price shown. See web or call for volume pricing.	12"	24"	36"	48"	60"	50CM
	\$242.55	\$263.27	\$283.98	\$304.70	\$325.40	\$255.82
Low PIM Corrugated Cable Assemblies						
SPP-250-LLPL Coax, 50 Ohm						
Part No. PE3C5894	0.280" dia.				48" dB/100ft	W
1 piece price shown. See web or call for volume pricing.	12"	24"	36"	48"	60"	50CM
	\$58.81	\$64.39	\$101.14	\$75.55	\$81.13	\$62.38
Low Loss Test Flexible Cable Assemblies						
PE-P300LL Coax, 50 Ohm						
Part No. PE3C3248	0.300" dia.				6 dB/100ft	W
1 piece price shown. See web or call for volume pricing.	12"	24"	36"	48"	60"	50CM
	\$332.67	\$357.87	\$383.08	\$408.28	\$433.48	\$348.81
Part No. PE3C1722	0.300" dia.				6 dB/100ft	W
1 piece price shown. See web or call for volume pricing.	12"	24"	36"	48"	60"	50CM
	\$260.98	\$286.92	\$312.84	\$338.79	\$364.72	\$277.59
Standard Formable Cable Assemblies						
PE-SR047FL Coax, 50 Ohm						
Part No. PE34197	0.047" dia.				36 dB/100ft	32 W
1 piece price shown. See web or call for volume pricing.	6"	12"	18"	24"	36"	48"
	\$120.52	\$127.76	\$124.20	\$127.89	\$135.26	\$142.63
PE-SR401FL Coax, 50 Ohm						
Part No. PE34202	* dia.				48" dB/100ft	279 W
1 piece price shown. See web or call for volume pricing.	6"	12"	18"	24"	36"	48"
	\$144.63	\$145.44	\$153.61	\$161.77	\$175.41	\$190.82
PE-SR402FL Coax, 50 Ohm						
Part No. PE39425	* dia.				12 dB/100ft	400 W
1 piece price shown. See web or call for volume pricing.	6"	9"	12"	18"	24"	Custom Len.
	\$43.20	\$41.24	\$43.20	\$47.38	\$51.56	See Web
Part No. PE3483	* dia.				12 dB/100ft	400 W
1 piece price shown. See web or call for volume pricing.	6"	12"	18"	24"	36"	48"
	\$56.62	\$60.54	\$64.58	\$68.62	\$76.70	\$87.54
PE-SR402FLJ Coax, 50 Ohm						
Part No. PE39439	0.161" dia.				12 dB/100ft	450 W
1 piece price shown. See web or call for volume pricing.	6"	9"	12"	18"	24"	Custom Len.
	\$51.02	\$47.24	\$51.02	\$55.34	\$59.66	See Web
PE-SR405FL Coax, 50 Ohm						
Part No. PE39417	* dia.				23 dB/100ft	105 W
1 piece price shown. See web or call for volume pricing.	6"	9"	12"	18"	24"	Custom Len.
	\$49.10	\$46.45	\$49.10	\$54.68	\$60.26	See Web
Part No. PE3958	* dia.				23 dB/100ft	130 W
1 piece price shown. See web or call for volume pricing.	6"	12"	18"	24"	36"	48"
	\$73.16	\$74.21	\$79.56	\$84.91	\$95.60	\$106.30

Part No.	Cable Dia.				Attn. @ 1 GHz	Power @ 1 GHz
Part No. PE3W03751	0.098" dia.				20 dB/100ft	122 W
1 piece price shown. See web or call for volume pricing.	12"	24"	36"	48"	60"	50CM
	\$65.54	\$74.49	\$83.44	\$92.40	\$101.35	\$71.28
Part No. PE3W02993	0.098" dia.				20 dB/100ft	122 W
1 piece price shown. See web or call for volume pricing.	12"	24"	36"	48"	60"	50CM
	\$48.24	\$57.19	\$66.14	\$75.10	\$84.06	\$53.98
Standard Flexible Cable Assemblies						
RG58C/U Coax, 50 Ohm						
Part No. PE3319	0.195" dia.				20 dB/100ft	44 W
1 piece price shown. See web or call for volume pricing.	6"	12"	18"	24"	36"	48"
	\$55.58	\$55.97	\$56.38	\$56.78	\$53.29	\$54.03
RG142B/U Coax, 50 Ohm						
Part No. PE3512	0.195" dia.				13 dB/100ft	650 W
1 piece price shown. See web or call for volume pricing.	6"	12"	18"	24"	36"	48"
	\$52.59	\$55.54	\$58.59	\$61.62	\$67.70	\$68.64
RG174A/U Coax, 50 Ohm						
Part No. PE3420	0.100" dia.				32 dB/100ft	16 W
1 piece price shown. See web or call for volume pricing.	6"	12"	18"	24"	36"	48"
	\$63.85	\$64.13	\$64.42	\$64.71	\$65.29	\$61.81
RG178B/U Coax, 50 Ohm						
Part No. PE3865	0.072" dia.				44 dB/100ft	78 W
1 piece price shown. See web or call for volume pricing.	6"	12"	18"	24"	36"	48"
	\$80.57	\$81.08	\$75.56	\$76.03	\$76.99	\$77.96
RG188A/U Coax, 50 Ohm						
Part No. PE3W04442	0.110" dia.				26 dB/100ft	160 W
1 piece price shown. See web or call for volume pricing.	12"	24"	36"	48"	60"	50CM
	\$54.25	\$56.92	\$59.59	\$62.26	\$64.93	\$55.95
Part No. PE3510	0.110" dia.				26 dB/100ft	160 W
1 piece price shown. See web or call for volume pricing.	6"	12"	18"	24"	36"	48"
	\$64.93	\$66.14	\$62.34	\$63.46	\$71.13	\$73.76
RG188-DS Coax, 50 Ohm						
Part No. PE3779	0.122" dia.				30 dB/100ft	160 W
1 piece price shown. See web or call for volume pricing.	6"	12"	18"	24"	36"	48"
	\$53.50	\$55.21	\$56.97	\$58.72	\$57.91	\$61.31
RG223/U Coax, 50 Ohm						
Part No. PE3429	0.210" dia.				13 dB/100ft	53 W
1 piece price shown. See web or call for volume pricing.	6"	12"	18"	24"	36"	48"
	\$57.71	\$59.21	\$60.77	\$62.33	\$65.45	\$68.74
RG316/U Coax, 50 Ohm						
Part No. PE3513	0.098" dia.				38 dB/100ft	160 W
1 piece price shown. See web or call for volume pricing.	6"	12"	18"	24"	36"	48"
	\$64.30	\$65.82	\$67.38	\$66.17	\$72.07	\$75.37
RG316-DS Coax, 50 Ohm						
Part No. PE3344	0.114" dia.				26 dB/100ft	160 W
1 piece price shown. See web or call for volume pricing.	6"	12"	18"	24"	36"	48"
	\$56.60	\$56.60	\$58.06	\$59.50	\$62.42	\$65.33
RG400/U Coax, 50 Ohm						
Part No. PE3003	0.195" dia.				15 dB/100ft	600 W
1 piece price shown. See web or call for volume pricing.	6"	12"	18"	24"	36"	48"
	\$63.79	\$67.38	\$71.08	\$74.78	\$82.17	\$90.00
PE-P086EAM Coax, 50 Ohm						
Part No. PE3CA1040	0.104" dia.				dB/100ft	W
1 piece price shown. See web or call for volume pricing.	12"	24"	36"	50CM	100CM	Custom Len.
	\$62.55	\$74.80	\$87.03	\$70.31	\$90.46	See Web
PE-P141EAM Coax, 50 Ohm						
Part No. PE3CA1036	0.163" dia.				dB/100ft	W
1 piece price shown. See web or call for volume pricing.	12"	24"	36"	50CM	100CM	Custom Len.
	\$72.34	\$91.43	\$110.52	\$84.57	\$115.89	See Web
Standard Semi-Rigid Cable Assemblies						
PE-020SR Coax, 50 Ohm						
Part No. PE34204	* dia.				85 dB/100ft	3 W
1 piece price shown. See web or call for volume pricing.	6"	12"	18"	24"	36"	48"
	\$136.98	\$160.38	\$154.56	\$163.38	\$180.97	\$198.55
PE-047SR Coax, 50 Ohm						

Cable Assemblies See Our Website For Current Pricing & Real-Time Stock Availability!

*Coax Performance at 1 GHz Notes: Cable assembly max frequency may be lower than connector or coax max frequency

For our complete selection of cable assemblies, please visit our website

Part No.	Cable Dia.				Attn. @ 1 GHz	Power @ 1 GHz
Part No. PE3230	1 piece price shown. See web or call for volume pricing.				* dia.	40 dB/100ft
6"	12"	18"	24"	36"	48"	Custom Len.
\$123.51	\$123.51	\$128.62	\$133.74	\$143.97	\$154.22	See Web
PE-SR047AL Coax, 50 Ohm						
Part No. PE3393	1 piece price shown. See web or call for volume pricing.				0.047" dia.	41 dB/100ft
6"	12"	18"	24"	36"	48"	Custom Len.
\$110.99	\$115.37	\$119.77	\$124.13	\$132.95	\$141.77	See Web
PE-SR402AL Coax, 50 Ohm						
Part No. PE34195	1 piece price shown. See web or call for volume pricing.				0.141" dia.	13 dB/100ft
6"	12"	18"	24"	36"	48"	Custom Len.
\$65.96	\$70.89	\$71.59	\$76.28	\$85.71	\$95.11	See Web
RG401/U Coax, 50 Ohm						
Part No. PE34220	1 piece price shown. See web or call for volume pricing.				* dia.	8 dB/100ft
6"	12"	18"	24"	36"	48"	Custom Len.
\$146.07	\$157.08	\$153.43	\$164.05	\$185.36	\$206.66	See Web
RG402/U Coax, 50 Ohm						
Part No. PE3821	1 piece price shown. See web or call for volume pricing.				* dia.	12 dB/100ft
6"	12"	18"	24"	36"	48"	Custom Len.
\$67.42	\$71.22	\$69.59	\$73.25	\$80.55	\$87.86	See Web
RG405/U Coax, 50 Ohm						
Part No. PE3822	1 piece price shown. See web or call for volume pricing.				* dia.	22 dB/100ft
6"	12"	18"	24"	36"	48"	Custom Len.
\$71.59	\$71.59	\$75.04	\$78.47	\$92.17	\$92.20	See Web
PE-SR401AL-STRAIGHT Coax, 50 Ohm						
Part No. PE34200	1 piece price shown. See web or call for volume pricing.				0.250" dia.	8 dB/100ft
6"	12"	18"	24"	36"	48"	Custom Len.
\$135.97	\$139.08	\$147.85	\$156.66	\$174.25	\$191.84	See Web
Standard Flexible Cable Assemblies						
RG59B/U Coax, 75 Ohm						
Part No. PE3137	1 piece price shown. See web or call for volume pricing.				0.242" dia.	12 dB/100ft
6"	12"	18"	24"	36"	48"	Custom Len.
\$68.69	\$69.16	\$69.57	\$70.06	\$70.95	\$71.87	See Web
RG179B/U Coax, 75 Ohm						
Part No. PE3459	1 piece price shown. See web or call for volume pricing.				0.100" dia.	25 dB/100ft
6"	12"	18"	24"	36"	48"	Custom Len.
\$62.65	\$62.65	\$63.83	\$65.01	\$67.38	\$69.74	See Web
RG62A/U Coax, 93 Ohm						
Part No. PE3411	1 piece price shown. See web or call for volume pricing.				0.242" dia.	13 dB/100ft
6"	12"	18"	24"	36"	48"	Custom Len.
\$68.92	\$69.57	\$70.24	\$70.90	\$72.23	\$73.54	See Web
RG180B/U Coax, 95 Ohm						
Part No. PE3352	1 piece price shown. See web or call for volume pricing.				0.115" dia.	dB/100ft
6"	12"	18"	24"	36"	48"	Custom Len.
\$59.32	\$61.24	\$63.15	\$65.07	\$68.99	\$72.82	See Web
SMA MALE TO SMA FEMALE						
Precision Formable Cable Assemblies						
PE-SR402FL Coax, 50 Ohm						
Part No. PE39426	1 piece price shown. See web or call for volume pricing.				* dia.	12 dB/100ft
6"	9"	12"	18"	24"	-	Custom Len.
\$40.29	\$36.62	\$40.29	\$44.31	\$48.33	-	See Web
PE-SR405FL Coax, 50 Ohm						
Part No. PE39418	1 piece price shown. See web or call for volume pricing.				* dia.	23 dB/100ft
6"	9"	12"	18"	24"	-	Custom Len.
\$37.92	\$40.21	\$40.21	\$45.56	\$50.90	-	See Web
PE-SR405FLJ Coax, 50 Ohm						
Part No. PE39432	1 piece price shown. See web or call for volume pricing.				0.098" dia.	20 dB/100ft
6"	9"	12"	18"	24"	-	Custom Len.
\$37.91	\$35.76	\$37.91	\$42.23	\$46.55	-	See Web
PE-80TEST Coax, 50 Ohm						
Part No. PE3TC0102	1 piece price shown. See web or call for volume pricing.				0.195" dia.	dB/100ft
24"	48"	72"	-	-	-	Custom Len.
\$356.84	\$442.58	\$528.33	-	-	-	See Web
Part No. PE3TC0202	1 piece price shown. See web or call for volume pricing.				0.195" dia.	dB/100ft
24"	48"	72"	-	-	-	Custom Len.
\$553.52	\$639.26	\$725.00	-	-	-	See Web



Low Loss Flexible Cable Assemblies						
PE-C100-LSZH Coax, 50 Ohm						
Part No. PE37995	1 piece price shown. See web or call for volume pricing.				0.109" dia.	25 dB/100ft
12"	24"	36"	48"	60"	-	Custom Len.
\$52.91	\$50.18	\$51.39	\$52.58	\$58.32	-	See Web
PE-C195 Coax, 50 Ohm						
Part No. PE36201	1 piece price shown. See web or call for volume pricing.				0.195" dia.	11 dB/100ft
12"	24"	36"	48"	60"	-	Custom Len.
\$46.98	\$47.76	\$45.75	\$46.46	\$47.17	-	See Web
PE-C240 Coax, 50 Ohm						
Part No. PE38638	1 piece price shown. See web or call for volume pricing.				0.240" dia.	9 dB/100ft
12"	24"	36"	48"	60"	-	Custom Len.
\$54.61	\$55.59	\$57.16	\$59.92	\$62.52	-	See Web
LMR-240 Coax, 50 Ohm						
Part No. PE3W02466	1 piece price shown. See web or call for volume pricing.				0.240" dia.	dB/100ft
12"	24"	36"	48"	60"	50CM	Custom Len.
\$48.90	\$49.84	\$50.78	\$51.72	\$52.67	\$49.51	See Web
PE-P142LL Coax, 50 Ohm						
Part No. PE340	1 piece price shown. See web or call for volume pricing.				0.195" dia.	7 dB/100ft
12"	24"	36"	48"	60"	50CM	Custom Len.
\$151.44	\$167.68	\$183.92	\$200.15	\$216.39	\$161.85	See Web
PE-P142LL-27478 Coax, 50 Ohm						
Part No. PE3M0126	1 piece price shown. See web or call for volume pricing.				0.195" dia.	dB/100ft
12"	18"	24"	36"	48"	60"	Custom Len.
\$414.58	\$423.06	\$431.54	\$448.49	\$465.45	\$482.41	See Web
LMR-240-UF Coax, 50 Ohm						
Part No. PE3W04971	1 piece price shown. See web or call for volume pricing.				0.240" dia.	9 dB/100ft
12"	24"	36"	48"	60"	50CM	Custom Len.
\$47.37	\$48.71	\$50.06	\$51.41	\$52.76	\$48.23	See Web
Low PIM Corrugated Cable Assemblies						
SPP-250-LLPL Coax, 50 Ohm						
Part No. PE3C5883	1 piece price shown. See web or call for volume pricing.				0.280" dia.	dB/100ft
12"	24"	36"	48"	60"	50CM	Custom Len.
\$58.08	\$63.66	\$69.24	\$74.82	\$80.40	\$61.65	See Web
Standard Formable Cable Assemblies						
PE-SR047FL Coax, 50 Ohm						
Part No. PE34228	1 piece price shown. See web or call for volume pricing.				0.047" dia.	36 dB/100ft
6"	12"	18"	24"	36"	48"	Custom Len.
\$95.72	\$95.72	\$109.35	\$103.09	\$110.47	\$117.83	See Web
PE-SR401FL Coax, 50 Ohm						
Part No. PE34233	1 piece price shown. See web or call for volume pricing.				* dia.	8 dB/100ft
6"	12"	18"	24"	36"	48"	Custom Len.
\$116.18	\$116.18	\$123.88	\$131.58	\$146.99	\$162.37	See Web
PE-SR402FL Coax, 50 Ohm						
Part No. PE3443	1 piece price shown. See web or call for volume pricing.				* dia.	12 dB/100ft
6"	12"	18"	24"	36"	48"	Custom Len.
\$57.06	\$60.99	\$60.23	\$64.00	\$71.55	\$79.08	See Web
PE-SR402FLJ Coax, 50 Ohm						
Part No. PE39440	1 piece price shown. See web or call for volume pricing.				0.161" dia.	12 dB/100ft
6"	9"	12"	18"	24"	-	Custom Len.
\$38.66	\$37.17	\$38.66	\$43.15	\$47.64	-	See Web
PE-SR405FL Coax, 50 Ohm						
Part No. PE3651	1 piece price shown. See web or call for volume pricing.				* dia.	23 dB/100ft
6"	12"	18"	24"	36"	48"	Custom Len.
\$69.64	\$69.64	\$80.89	\$86.56	\$91.03	\$101.72	See Web
Standard Flexible Cable Assemblies						
RG58C/U Coax, 50 Ohm						
Part No. PE3078	1 piece price shown. See web or call for volume pricing.				0.195" dia.	20 dB/100ft
6"	12"	18"	24"	36"	48"	Custom Len.
\$53.09	\$57.34	\$53.47	\$53.83	\$58.96	\$55.31	See Web
RG142B/U Coax, 50 Ohm						
Part No. PE3611	1 piece price shown. See web or call for volume pricing.				0.195" dia.	13 dB/100ft
6"	12"	18"	24"	36"	48"	Custom Len.
\$51.47	\$54.42	\$52.36	\$55.21	\$66.58	\$66.67	See Web
RG174A/U Coax, 50 Ohm						

Cable Assemblies

See Our Website For Current Pricing & Real-Time Stock Availability!

Continued on Next Page

For Custom Lengths, Metric Lengths or Special Configurations, Please call (949) 261-1920

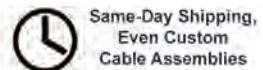
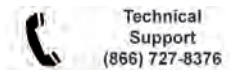

For our complete selection of cable assemblies, please visit our website

Part No.	Cable Dia.				Attn. @ 1 GHz	Power @ 1 GHz
Part No. PE3715	1 piece price shown. See web or call for volume pricing.				0.100" dia.	32 dB/100ft
6"	12"	18"	24"	36"	48"	Custom Len.
\$56.09	\$56.37	\$56.66	\$53.60	\$57.52	\$58.13	See Web
RG178B/U Coax, 50 Ohm						
Part No. PE3056	1 piece price shown. See web or call for volume pricing.				0.072" dia.	44 dB/100ft
6"	12"	18"	24"	36"	48"	Custom Len.
\$69.31	\$65.87	\$66.36	\$70.88	\$71.94	\$68.75	See Web
RG188A/U Coax, 50 Ohm						
Part No. PE3706	1 piece price shown. See web or call for volume pricing.				0.110" dia.	26 dB/100ft
6"	12"	18"	24"	36"	48"	Custom Len.
\$56.02	\$56.02	\$57.12	\$58.24	\$60.46	\$62.68	See Web
RG223/U Coax, 50 Ohm						
Part No. PE3697	1 piece price shown. See web or call for volume pricing.				0.210" dia.	13 dB/100ft
6"	12"	18"	24"	36"	48"	Custom Len.
\$46.96	\$48.47	\$50.03	\$51.59	\$54.70	\$54.43	See Web
RG316/U Coax, 50 Ohm						
Part No. PE3832	1 piece price shown. See web or call for volume pricing.				0.098" dia.	38 dB/100ft
6"	12"	18"	24"	36"	48"	Custom Len.
\$57.81	\$59.33	\$60.90	\$62.45	\$61.75	\$68.89	See Web
RG316-DS Coax, 50 Ohm						
Part No. PE3171	1 piece price shown. See web or call for volume pricing.				0.114" dia.	26 dB/100ft
6"	12"	18"	24"	36"	48"	Custom Len.
\$63.14	\$59.87	\$61.32	\$67.78	\$70.90	\$68.61	See Web
RG400/U Coax, 50 Ohm						
Part No. PE3864	1 piece price shown. See web or call for volume pricing.				0.195" dia.	15 dB/100ft
6"	12"	18"	24"	36"	48"	Custom Len.
\$57.72	\$57.72	\$61.21	\$64.69	\$71.66	\$78.63	See Web
PE-P141 Coax, 50 Ohm						
Part No. PE3C1876	1 piece price shown. See web or call for volume pricing.				0.163" dia.	11 dB/100ft
12"	24"	36"	48"	60"	50CM	Custom Len.
\$53.70	\$65.50	\$77.30	\$89.10	\$100.91	\$61.25	See Web
PE-P195 Coax, 50 Ohm						
Part No. PE3160	1 piece price shown. See web or call for volume pricing.				0.195" dia.	13 dB/100ft
6"	12"	18"	24"	36"	48"	Custom Len.
\$62.57	\$66.32	\$66.98	\$71.42	\$80.27	\$89.13	See Web
PE-VNA-R Coax, 50 Ohm						
Part No. PE3VNA1802	1 piece price shown. See web or call for volume pricing.				0.430" dia.	dB/100ft
24"	48"	-	-	-	-	Custom Len.
\$791.80	\$880.58	-	-	-	-	See Web
Standard Semi-Rigid Cable Assemblies						
PE-020SR Coax, 50 Ohm						
Part No. PE34224	1 piece price shown. See web or call for volume pricing.				" dia.	85 dB/100ft
6"	12"	18"	24"	36"	48"	Custom Len.
\$135.96	\$144.77	\$153.64	\$162.35	\$179.94	\$197.52	See Web
PE-034SR Coax, 50 Ohm						
Part No. PE34226	1 piece price shown. See web or call for volume pricing.				" dia.	60 dB/100ft
6"	12"	18"	24"	36"	48"	Custom Len.
\$146.41	\$146.41	\$152.55	\$158.70	\$170.99	\$192.80	See Web
PE-047SR Coax, 50 Ohm						
Part No. PE3188	1 piece price shown. See web or call for volume pricing.				" dia.	40 dB/100ft
6"	12"	18"	24"	36"	48"	Custom Len.
\$98.63	\$98.63	\$103.75	\$108.88	\$119.11	\$129.35	See Web
PE-SR047AL Coax, 50 Ohm						
Part No. PE3253	1 piece price shown. See web or call for volume pricing.				" dia.	41 dB/100ft
6"	12"	18"	24"	36"	48"	Custom Len.
\$92.54	\$91.96	\$96.34	\$100.73	\$109.54	\$118.31	See Web
PE-SR402AL Coax, 50 Ohm						
Part No. PE34235	1 piece price shown. See web or call for volume pricing.				0.141" dia.	13 dB/100ft
6"	12"	18"	24"	36"	48"	Custom Len.
\$56.96	\$61.89	\$66.98	\$68.93	\$78.33	\$87.75	See Web
PE-SR405AL Coax, 50 Ohm						
Part No. PE34237	1 piece price shown. See web or call for volume pricing.				" dia.	23 dB/100ft
6"	12"	18"	24"	36"	48"	Custom Len.
\$58.30	\$62.51	\$66.70	\$70.84	\$79.23	\$87.59	See Web
RG401/U Coax, 50 Ohm						
Part No. PE33896	1 piece price shown. See web or call for volume pricing.				" dia.	8 dB/100ft
6"	12"	18"	24"	36"	48"	Custom Len.
\$122.93	\$122.93	\$141.65	\$144.89	\$166.83	\$188.78	See Web

Part No.	Cable Dia.				Attn. @ 1 GHz	Power @ 1 GHz
Part No. PE3823	1 piece price shown. See web or call for volume pricing.				" dia.	12 dB/100ft
6"	12"	18"	24"	36"	48"	Custom Len.
\$56.99	\$57.34	\$64.70	\$64.65	\$71.96	\$84.71	See Web
RG405/U Coax, 50 Ohm						
Part No. PE3824	1 piece price shown. See web or call for volume pricing.				" dia.	22 dB/100ft
6"	12"	18"	24"	36"	48"	Custom Len.
\$67.26	\$65.62	\$69.06	\$72.50	\$79.36	\$86.24	See Web
PE-SR401AL-STRAIGHT Coax, 50 Ohm						
Part No. PE34230	1 piece price shown. See web or call for volume pricing.				0.250" dia.	8 dB/100ft
6"	12"	18"	24"	36"	48"	Custom Len.
\$103.48	\$112.26	\$121.06	\$129.84	\$147.42	\$165.02	See Web
Standard Flexible Cable Assemblies						
RG55B/U Coax, 53 Ohm						
Part No. PE3093	1 piece price shown. See web or call for volume pricing.				0.202" dia.	17 dB/100ft
6"	12"	18"	24"	36"	48"	Custom Len.
\$40.54	\$41.62	\$42.70	\$43.76	\$45.93	\$48.10	See Web
RG59B/U Coax, 75 Ohm						
Part No. PE3333	1 piece price shown. See web or call for volume pricing.				0.242" dia.	12 dB/100ft
6"	12"	18"	24"	36"	48"	Custom Len.
\$69.30	\$69.30	\$69.78	\$74.50	\$71.22	\$72.19	See Web
RG179B/U Coax, 75 Ohm						
Part No. PE3102	1 piece price shown. See web or call for volume pricing.				0.100" dia.	29 dB/100ft
6"	12"	18"	24"	36"	48"	Custom Len.
\$56.28	\$61.91	\$57.46	\$58.64	\$61.01	\$69.74	See Web
SMA MALE TO SMA FEMALE BULKHEAD						
SEE MOUNTING HOLE SECTION ON PAGE 369						
Low Loss Flexible Cable Assemblies						
PE-C100-LSZH Coax, 50 Ohm						
Part No. PE38240	1 piece price shown. See web or call for volume pricing.				0.109" dia.	25 dB/100ft
12"	24"	36"	48"	60"	-	Custom Len.
\$52.68	\$49.97	\$51.18	\$52.39	\$53.58	-	See Web
PE-C195 Coax, 50 Ohm						
Part No. PE36417	1 piece price shown. See web or call for volume pricing.				0.195" dia.	11 dB/100ft
12"	24"	36"	48"	60"	-	Custom Len.
\$39.75	\$41.07	\$42.39	\$43.71	\$45.09	-	See Web
LMR-195 Coax, 50 Ohm						
Part No. PE3C5767	1 piece price shown. See web or call for volume pricing.				0.195" dia.	12 dB/100ft
12"	24"	36"	48"	60"	50CM	Custom Len.
\$49.24	\$49.86	\$50.17	\$50.79	\$51.41	\$49.33	See Web
PE-P142LL-27478 Coax, 50 Ohm						
Part No. PE3M0127	1 piece price shown. See web or call for volume pricing.				0.195" dia.	dB/100ft
12"	18"	24"	36"	48"	60"	Custom Len.
\$447.24	\$455.72	\$464.19	\$481.15	\$498.11	\$515.06	See Web
PE-P160LL-27478 Coax, 50 Ohm						
Part No. PE3M0181	1 piece price shown. See web or call for volume pricing.				0.160" dia.	dB/100ft
8"	12"	18"	24"	30"	36"	Custom Len.
\$442.62	\$447.52	\$454.87	\$462.22	\$469.58	\$476.92	See Web
PE-P160LL Coax, 50 Ohm						
Part No. PE3C5242	1 piece price shown. See web or call for volume pricing.				0.160" dia.	50CM
12"	24"	36"	48"	60"	50CM	Custom Len.
\$222.45	\$243.17	\$263.87	\$284.59	\$305.30	\$235.72	See Web
Standard Formable Cable Assemblies						
PE-SR401FL Coax, 50 Ohm						
Part No. PE34249	1 piece price shown. See web or call for volume pricing.				" dia.	8 dB/100ft
6"	12"	18"	24"	36"	48"	Custom Len.
\$111.46	\$118.97	\$126.42	\$133.92	\$148.86	\$163.80	See Web
PE-SR402FLJ Coax, 50 Ohm						
Part No. PE39441	1 piece price shown. See web or call for volume pricing.				0.161" dia.	12 dB/100ft
6"	9"	12"	18"	24"	-	Custom Len.
\$40.78	\$37.07	\$40.78	\$45.10	\$49.42	-	See Web
PE-SR405FL Coax, 50 Ohm						
Part No. PE39419	1 piece price shown. See web or call for volume pricing.				" dia.	23 dB/100ft
4"	6"	9"	12"	18"	24"	Custom Len.
\$43.56	\$49.56	\$46.90	\$49.56	\$55.14	\$60.72	See Web



Cable Assemblies

See Our Website For Current Pricing & Real-Time Stock Availability!

*Coax Performance at 1 GHz Notes: Cable assembly max frequency may be lower than connector or coax max frequency

For our complete selection of cable assemblies, please visit our website

Part No.	Cable Dia.				Attn. @ 1 GHz	Power @ 1 GHz
Part No. PE3961	1 piece price shown. See web or call for volume pricing.				* dia.	23 dB/100ft 130 W
6"	12"	18"	24"	36"	48"	Custom Len.
\$65.02	\$70.53	\$76.20	\$75.99	\$86.69	\$97.39	See Web
PE-SR405FLJ Coax, 50 Ohm						
Part No. PE39433	1 piece price shown. See web or call for volume pricing.				0.098" dia.	20 dB/100ft 130 W
6"	9"	12"	18"	24"	-	Custom Len.
\$18.37	\$39.46	\$18.37	\$22.69	\$27.01	-	See Web
Standard Flexible Cable Assemblies						
RG58C/U Coax, 50 Ohm						
Part No. PE3956	1 piece price shown. See web or call for volume pricing.				0.195" dia.	dB/100ft W
6"	12"	18"	24"	36"	48"	Custom Len.
\$47.38	\$47.74	\$48.10	\$48.45	\$49.18	\$49.96	See Web
RG142B/U Coax, 50 Ohm						
Part No. PE3494	1 piece price shown. See web or call for volume pricing.				0.195" dia.	13 dB/100ft 650 W
6"	12"	18"	24"	36"	48"	Custom Len.
\$54.76	\$57.71	\$60.75	\$63.78	\$64.90	\$76.30	See Web
RG174A/U Coax, 50 Ohm						
Part No. PE3184	1 piece price shown. See web or call for volume pricing.				0.110" dia.	32 dB/100ft 17 W
6"	12"	18"	24"	36"	48"	Custom Len.
\$59.45	\$59.73	\$60.02	\$60.31	\$60.90	\$61.51	See Web
RG178B/U Coax, 50 Ohm						
Part No. PE3959	1 piece price shown. See web or call for volume pricing.				0.072" dia.	44 dB/100ft 78 W
6"	12"	18"	24"	36"	48"	Custom Len.
\$53.23	\$56.42	\$56.95	\$57.48	\$58.54	\$56.10	See Web
RG188A/U Coax, 50 Ohm						
Part No. PE3051	1 piece price shown. See web or call for volume pricing.				0.110" dia.	26 dB/100ft 160 W
6"	12"	18"	24"	36"	48"	Custom Len.
\$50.87	\$52.09	\$50.25	\$54.58	\$53.57	\$59.71	See Web
RG223/U Coax, 50 Ohm						
Part No. PE3553	1 piece price shown. See web or call for volume pricing.				0.210" dia.	13 dB/100ft 53 W
6"	12"	18"	24"	36"	48"	Custom Len.
\$54.08	\$50.54	\$51.98	\$58.70	\$56.32	\$65.11	See Web
RG316/U Coax, 50 Ohm						
Part No. PE3835	1 piece price shown. See web or call for volume pricing.				0.098" dia.	38 dB/100ft 160 W
6"	12"	18"	24"	36"	48"	Custom Len.
\$53.53	\$55.05	\$56.62	\$53.86	\$56.76	\$59.65	See Web
RG400/U Coax, 50 Ohm						
Part No. PE3924	1 piece price shown. See web or call for volume pricing.				0.195" dia.	15 dB/100ft 650 W
6"	12"	18"	24"	36"	48"	Custom Len.
\$62.97	\$66.57	\$65.11	\$73.96	\$75.57	\$82.54	See Web
PE-P086EAM Coax, 50 Ohm						
Part No. PE3CA1042	1 piece price shown. See web or call for volume pricing.				0.104" dia.	dB/100ft W
12"	24"	36"	50CM	100CM	-	Custom Len.
\$62.55	\$74.80	\$97.48	\$70.31	\$113.14	-	See Web
PE-P195 Coax, 50 Ohm						
Part No. PE3799	1 piece price shown. See web or call for volume pricing.				0.195" dia.	13 dB/100ft 650 W
6"	12"	18"	24"	36"	48"	Custom Len.
\$55.06	\$59.32	\$63.64	\$72.45	\$82.03	\$85.05	See Web
Standard Semi-Rigid Cable Assemblies						
PE-SR402AL Coax, 50 Ohm						
Part No. PE34252	1 piece price shown. See web or call for volume pricing.				0.141" dia.	13 dB/100ft 450 W
6"	12"	18"	24"	36"	48"	Custom Len.
\$62.77	\$61.55	\$66.25	\$70.96	\$80.37	\$89.79	See Web
PE-SR405AL Coax, 50 Ohm						
Part No. PE34254	1 piece price shown. See web or call for volume pricing.				* dia.	23 dB/100ft 130 W
6"	12"	18"	24"	36"	48"	Custom Len.
\$58.54	\$58.47	\$67.91	\$66.82	\$75.22	\$83.57	See Web
RG401/U Coax, 50 Ohm						
Part No. PE34256	1 piece price shown. See web or call for volume pricing.				* dia.	8 dB/100ft 870 W
6"	12"	18"	24"	36"	48"	Custom Len.
\$114.65	\$125.27	\$135.96	\$146.58	\$167.89	\$189.18	See Web
RG402/U Coax, 50 Ohm						
Part No. PE3825	1 piece price shown. See web or call for volume pricing.				* dia.	12 dB/100ft 650 W
6"	12"	18"	24"	36"	48"	Custom Len.
\$60.28	\$59.34	\$62.99	\$66.64	\$73.95	\$81.25	See Web
Part No. PE3C2892	1 piece price shown. See web or call for volume pricing.				* dia.	12 dB/100ft 650 W
6"	12"	18"	24"	36"	48"	Custom Len.
\$44.86	\$44.86	\$55.49	\$59.03	\$66.12	\$73.20	See Web

Part No.	Cable Dia.				Attn. @ 1 GHz	Power @ 1 GHz
Part No. PE3826	1 piece price shown. See web or call for volume pricing.				* dia.	22 dB/100ft 130 W
6"	12"	18"	24"	36"	48"	Custom Len.
\$59.00	\$64.91	\$68.62	\$72.34	\$72.75	\$79.62	See Web
PE-SR401AL-STRAIGHT Coax, 50 Ohm						
Part No. PE34247	1 piece price shown. See web or call for volume pricing.				0.250" dia.	8 dB/100ft 1400 W
6"	12"	18"	24"	36"	48"	Custom Len.
\$128.92	\$128.92	\$137.99	\$147.06	\$165.20	\$183.35	See Web
Standard Flexible Cable Assemblies						
RG55B/U Coax, 53 Ohm						
Part No. PE3940	1 piece price shown. See web or call for volume pricing.				0.202" dia.	17 dB/100ft 53 W
6"	12"	18"	24"	36"	48"	Custom Len.
\$49.66	\$49.66	\$50.80	\$51.92	\$54.16	\$56.40	See Web
RG59B/U Coax, 75 Ohm						
Part No. PE3871	1 piece price shown. See web or call for volume pricing.				0.242" dia.	12 dB/100ft 77 W
6"	12"	18"	24"	36"	48"	Custom Len.
\$63.88	\$64.36	\$64.78	\$65.27	\$66.15	\$67.07	See Web
RG179B/U Coax, 75 Ohm						
Part No. PE3967	1 piece price shown. See web or call for volume pricing.				0.100" dia.	25 dB/100ft 200 W
6"	12"	18"	24"	36"	48"	Custom Len.
\$57.86	\$57.86	\$59.06	\$60.23	\$62.59	\$70.31	See Web
SMA MALE TO REVERSE POLARITY SMA MALE						
						
Low Loss Flexible Cable Assemblies						
PE-C100-LSZH Coax, 50 Ohm						
Part No. PE37900	1 piece price shown. See web or call for volume pricing.				0.109" dia.	25 dB/100ft W
12"	24"	36"	48"	60"	-	Custom Len.
\$50.08	\$51.41	\$48.78	\$49.98	\$51.19	-	See Web
LMR-240 Coax, 50 Ohm						
Part No. PE3W00906	1 piece price shown. See web or call for volume pricing.				0.240" dia.	8 dB/100ft W
12"	24"	36"	48"	60"	50CM	Custom Len.
\$57.33	\$58.28	\$59.21	\$60.16	\$61.10	\$57.93	See Web
Standard Flexible Cable Assemblies						
RG58C/U Coax, 50 Ohm						
Part No. PE34116	1 piece price shown. See web or call for volume pricing.				0.195" dia.	20 dB/100ft 44 W
12"	24"	36"	48"	60"	72"	Custom Len.
\$59.61	\$60.42	\$56.66	\$57.39	\$58.13	\$58.87	See Web
RG142B/U Coax, 50 Ohm						
Part No. PE34614	1 piece price shown. See web or call for volume pricing.				0.195" dia.	13 dB/100ft 650 W
12"	24"	36"	48"	60"	72"	Custom Len.
\$52.21	\$57.93	\$63.66	\$69.41	\$75.13	\$80.87	See Web
RG174A/U Coax, 50 Ohm						
Part No. PE34331	1 piece price shown. See web or call for volume pricing.				0.100" dia.	32 dB/100ft 16 W
12"	24"	36"	48"	60"	72"	Custom Len.
\$54.76	\$51.15	\$51.59	\$52.01	\$52.45	\$52.89	See Web
RG178B/U Coax, 50 Ohm						
Part No. PE35208	1 piece price shown. See web or call for volume pricing.				0.072" dia.	44 dB/100ft 78 W
12"	24"	36"	48"	60"	72"	Custom Len.
\$71.97	\$73.03	\$67.37	\$68.32	\$69.28	\$70.24	See Web
RG188A/U Coax, 50 Ohm						
Part No. PE35210	1 piece price shown. See web or call for volume pricing.				0.110" dia.	26 dB/100ft 160 W
12"	24"	36"	48"	60"	72"	Custom Len.
\$52.52	\$54.74	\$56.96	\$59.18	\$61.40	\$63.62	See Web
RG223/U Coax, 50 Ohm						
Part No. PE34398	1 piece price shown. See web or call for volume pricing.				0.210" dia.	13 dB/100ft 53 W
12"	24"	36"	48"	60"	72"	Custom Len.
\$48.45	\$51.36	\$54.25	\$57.15	\$60.04	\$67.23	See Web
RG316/U Coax, 50 Ohm						
Part No. PE35212	1 piece price shown. See web or call for volume pricing.				0.098" dia.	38 dB/100ft 160 W
12"	24"	36"	48"	60"	72"	Custom Len.
\$53.50	\$56.63	\$59.75	\$58.54	\$61.54	\$64.54	See Web
RG316-DS Coax, 50 Ohm						
Part No. PE36963	1 piece price shown. See web or call for volume pricing.				0.114" dia.	26 dB/100ft 160 W
12"	24"	36"	48"	60"	-	Custom Len.
\$57.50	\$56.14	\$63.74	\$61.97	\$64.88	-	See Web

Cable Assemblies

See Our Website For Current Pricing & Real-Time Stock Availability!

For Custom Lengths, Metric Lengths or Special Configurations, Please call (949) 261-1920

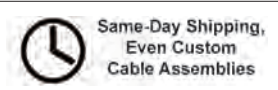

For our complete selection of cable assemblies, please visit our website

SMA MALE TO REVERSE THREAD SMA MALE



Standard Flexible Cable Assemblies

RG58C/U Coax, 50 Ohm

Part No. PE35351	Cable Dia.	Attn. @ 1 GHz	Power @ 1 GHz
1 piece price shown. See web or call for volume pricing.			
12"	24"	36"	48"
\$51.10	\$51.83	\$52.54	\$53.26
60"	72"	Custom Len.	See Web
\$53.99	\$54.76		

RG142B/U Coax, 50 Ohm

Part No. PE35355	Cable Dia.	Attn. @ 1 GHz	Power @ 1 GHz
1 piece price shown. See web or call for volume pricing.			
12"	24"	36"	48"
\$53.06	\$58.60	\$64.18	\$69.71
60"	72"	Custom Len.	See Web
\$75.29	\$80.80		

RG223/U Coax, 50 Ohm

Part No. PE35371	Cable Dia.	Attn. @ 1 GHz	Power @ 1 GHz
1 piece price shown. See web or call for volume pricing.			
12"	24"	36"	48"
\$54.46	\$57.36	\$60.26	\$63.15
60"	72"	Custom Len.	See Web
\$66.06	\$68.96		

RG316/U Coax, 50 Ohm

Part No. PE35375	Cable Dia.	Attn. @ 1 GHz	Power @ 1 GHz
1 piece price shown. See web or call for volume pricing.			
12"	24"	36"	48"
\$55.23	\$58.23	\$61.24	\$64.24
60"	72"	Custom Len.	See Web
\$67.23	\$70.24		

SMA MALE TO SMB PLUG



Standard Formable Cable Assemblies

PE-SR405FL Coax, 50 Ohm

Part No. PE34764	Cable Dia.	Attn. @ 1 GHz	Power @ 1 GHz
1 piece price shown. See web or call for volume pricing.			
12"	24"	36"	48"
\$60.17	\$71.76	\$83.36	\$94.95
60"	72"	Custom Len.	See Web
\$106.55	-		

Standard Flexible Cable Assemblies

PE-B100 Coax, 50 Ohm

Part No. PE34455	Cable Dia.	Attn. @ 1 GHz	Power @ 1 GHz
1 piece price shown. See web or call for volume pricing.			
6"	12"	18"	24"
\$52.13	\$55.25	\$55.67	\$59.21
36"	48"	Custom Len.	See Web
\$66.31	\$73.39		

RG58C/U Coax, 50 Ohm

Part No. PE3172	Cable Dia.	Attn. @ 1 GHz	Power @ 1 GHz
1 piece price shown. See web or call for volume pricing.			
6"	12"	18"	24"
\$51.46	\$55.58	\$51.83	\$56.40
36"	48"	Custom Len.	See Web
\$57.21	\$53.66		

RG142B/U Coax, 50 Ohm

Part No. PE3181	Cable Dia.	Attn. @ 1 GHz	Power @ 1 GHz
1 piece price shown. See web or call for volume pricing.			
6"	12"	18"	24"
\$49.93	\$49.93	\$55.97	\$55.67
36"	48"	Custom Len.	See Web
\$65.08	\$67.13		

RG174A/U Coax, 50 Ohm

Part No. PE3908	Cable Dia.	Attn. @ 1 GHz	Power @ 1 GHz
1 piece price shown. See web or call for volume pricing.			
6"	12"	18"	24"
\$46.60	\$46.88	\$47.17	\$44.67
36"	48"	Custom Len.	See Web
\$48.04	\$48.66		

RG178B/U Coax, 50 Ohm

Part No. PE3548	Cable Dia.	Attn. @ 1 GHz	Power @ 1 GHz
1 piece price shown. See web or call for volume pricing.			
6"	12"	18"	24"
\$61.46	\$61.98	\$57.86	\$58.35
36"	48"	Custom Len.	See Web
\$64.10	\$60.26		

RG188A/U Coax, 50 Ohm

Part No. PE3755	Cable Dia.	Attn. @ 1 GHz	Power @ 1 GHz
1 piece price shown. See web or call for volume pricing.			
6"	12"	18"	24"
\$46.89	\$46.89	\$48.01	\$49.11
36"	48"	Custom Len.	See Web
\$51.34	\$53.55		

RG188-DS Coax, 50 Ohm

Part No. PE3722	Cable Dia.	Attn. @ 1 GHz	Power @ 1 GHz
1 piece price shown. See web or call for volume pricing.			
6"	12"	18"	24"
\$41.64	\$41.64	\$43.35	\$45.05
36"	48"	Custom Len.	See Web
\$48.45	\$51.86		

RG196A/U Coax, 50 Ohm

Part No. PE34448	Cable Dia.	Attn. @ 1 GHz	Power @ 1 GHz
1 piece price shown. See web or call for volume pricing.			
6"	12"	18"	24"
\$57.78	\$57.78	\$58.45	\$59.14
36"	48"	Custom Len.	See Web
\$60.51	\$61.89		

RG223/U Coax, 50 Ohm

Part No. PE3187	Cable Dia.	Attn. @ 1 GHz	Power @ 1 GHz
1 piece price shown. See web or call for volume pricing.			
6"	12"	18"	24"
\$47.10	\$49.92	\$48.55	\$53.04
36"	48"	Custom Len.	See Web
\$52.90	\$59.45		

RG316/U Coax, 50 Ohm

Part No. PE3810	Cable Dia.	Attn. @ 1 GHz	Power @ 1 GHz
1 piece price shown. See web or call for volume pricing.			
6"	12"	18"	24"
\$47.41	\$48.93	\$50.49	\$52.04
36"	48"	Custom Len.	See Web
\$55.17	\$58.47		

RG316-DS Coax, 50 Ohm

Part No. PE33657	Cable Dia.	Attn. @ 1 GHz	Power @ 1 GHz
1 piece price shown. See web or call for volume pricing.			
6"	12"	18"	24"
\$49.52	\$52.49	\$54.05	\$55.62
36"	48"	Custom Len.	See Web
\$58.73	\$62.05		

RG400/U Coax, 50 Ohm

Part No. PE34452	Cable Dia.	Attn. @ 1 GHz	Power @ 1 GHz
1 piece price shown. See web or call for volume pricing.			
6"	12"	18"	24"
\$59.06	\$64.96	\$62.54	\$66.03
36"	48"	Custom Len.	See Web
\$79.75	\$79.97		

Standard Semi-Rigid Cable Assemblies

RG405/U Coax, 50 Ohm

Part No. PE35527	Cable Dia.	Attn. @ 1 GHz	Power @ 1 GHz
1 piece price shown. See web or call for volume pricing.			
12"	24"	36"	48"
\$52.91	\$64.56	\$66.64	\$73.52
60"	-	Custom Len.	See Web
\$80.38	-		

SMA MALE TO SMB PLUG RIGHT ANGLE



Low Loss Flexible Cable Assemblies

PE-C100-LSZH Coax, 50 Ohm

Part No. PE3W00416	Cable Dia.	Attn. @ 1 GHz	Power @ 1 GHz
1 piece price shown. See web or call for volume pricing.			
12"	24"	36"	48"
\$33.18	\$34.46	\$35.75	\$37.04
60"	50CM	Custom Len.	See Web
\$38.33	\$34.00		

Standard Flexible Cable Assemblies

RG174A/U Coax, 50 Ohm

Part No. PE3W03030	Cable Dia.	Attn. @ 1 GHz	Power @ 1 GHz
1 piece price shown. See web or call for volume pricing.			
12"	24"	36"	48"
\$37.47	\$38.03	\$38.59	\$39.15
60"	50CM	Custom Len.	See Web
\$39.71	\$37.82		

Part No. PE3W04476	Cable Dia.	Attn. @ 1 GHz	Power @ 1 GHz
1 piece price shown. See web or call for volume pricing.			
12"	24"	36"	48"
\$41.26	\$41.82	\$42.38	\$42.94
60"	50CM	Custom Len.	See Web
\$43.50	\$41.61		

SMA MALE TO SMB JACK



Standard Flexible Cable Assemblies

RG316/U Coax, 50 Ohm

Part No. PE3W03014	Cable Dia.	Attn. @ 1 GHz	Power @ 1 GHz
1 piece price shown. See web or call for volume pricing.			
12"	24"	36"	48"
\$39.25	\$42.53	\$45.81	\$49.09
60"	50CM	Custom Len.	See Web
\$52.38	\$41.35		

RG316-DS Coax, 50 Ohm

Part No. PE3W05361	Cable Dia.	Attn. @ 1 GHz	Power @ 1 GHz
1 piece price shown. See web or call for volume pricing.			
12"	24"	36"	48"
\$65.24	\$68.48	\$71.73	\$74.98
60"	50CM	Custom Len.	See Web
\$78.24	\$67.32		

SMA MALE TO SMC PLUG



Standard Flexible Cable Assemblies

RG58C/U Coax, 50 Ohm

Part No. PE3210	Cable Dia.	Attn. @ 1 GHz	Power @ 1 GHz
1 piece price shown. See web or call for volume pricing.			
6"	12"	18"	24"
\$54.99	\$54.99	\$55.36	\$55.73
36"	48"	Custom Len.	See Web
\$56.47	\$57.20		

RG174A/U Coax, 50 Ohm

Part No. PE3944	Cable Dia.	Attn. @ 1 GHz	Power @ 1 GHz
1 piece price shown. See web or call for volume pricing.			
6"	12"	18"	24"
\$51.42	\$51.42	\$51.64	\$51.86
36"	48"	Custom Len.	See Web
\$52.29	\$52.73		

RG178B/U Coax, 50 Ohm

Part No. PE3561	Cable Dia.	Attn. @ 1 GHz	Power @ 1 GHz
1 piece price shown. See web or call for volume pricing.			
6"	12"	18"	24"
\$53.06	\$53.56	\$54.04	\$54.51
36"	48"	Custom Len.	See Web
\$55.48	\$56.43		

RG188A/U Coax, 50 Ohm

Part No. PE3736	Cable Dia.	Attn. @ 1 GHz	Power @ 1 GHz
1 piece price shown. See web or call for volume pricing.			
6"	12"	18"	24"
\$41.57	\$42.63	\$43.71	\$44.74
36"	48"	Custom Len.	See Web
\$46.89	\$49.06		

RG188-DS Coax, 50 Ohm

Cable Assemblies
See Our Website For Current Pricing & Real-Time Stock Availability!

*Coax Performance at 1 GHz Notes: Cable assembly max frequency may be lower than connector or coax max frequency

For our complete selection of cable assemblies, please visit our website

Part No. PE34458					Cable Dia.	Attn. @ 1 GHz	Power @ 1 GHz
1 piece price shown. See web or call for volume pricing.					0.122" dia.	30 dB/100ft	160 W
6"	12"	18"	24"		36"	48"	Custom Len.
\$45.99	\$45.99	\$47.68	\$49.38	\$52.78	\$56.18		See Web

Part No. PE3226					Cable Dia.	Attn. @ 1 GHz	Power @ 1 GHz
1 piece price shown. See web or call for volume pricing.					0.209" dia.	13 dB/100ft	50 W
6"	12"	18"	24"		36"	48"	Custom Len.
\$51.37	\$51.37	\$52.81	\$54.27	\$57.17	\$60.05		See Web

Part No. PE3809					Cable Dia.	Attn. @ 1 GHz	Power @ 1 GHz
1 piece price shown. See web or call for volume pricing.					0.098" dia.	38 dB/100ft	160 W
6"	12"	18"	24"		36"	48"	Custom Len.
\$47.83	\$47.83	\$49.27	\$54.78	\$53.60	\$56.49		See Web

Part No. PE34456					Cable Dia.	Attn. @ 1 GHz	Power @ 1 GHz
1 piece price shown. See web or call for volume pricing.					0.114" dia.	26 dB/100ft	160 W
6"	12"	18"	24"		36"	48"	Custom Len.
\$41.95	\$41.95	\$43.41	\$47.60	\$50.72	\$50.68		See Web

SMA MALE TO SMP FEMALE



Standard Formable Cable Assemblies

Part No. PE36164					Cable Dia.	Attn. @ 1 GHz	Power @ 1 GHz
1 piece price shown. See web or call for volume pricing.					0.047" dia.	36 dB/100ft	32 W
12"	24"	36"	48"		60"	72"	Custom Len.
\$90.82	\$98.94	\$100.41	\$115.66	\$115.15	\$122.53		See Web

Part No. PE36168					Cable Dia.	Attn. @ 1 GHz	Power @ 1 GHz
1 piece price shown. See web or call for volume pricing.					0.047" dia.	23 dB/100ft	130 W
12"	24"	36"	48"		60"	72"	Custom Len.
\$83.30	\$94.64	\$105.99	\$112.18	\$129.55	\$133.57		See Web

Part No. PE36166					Cable Dia.	Attn. @ 1 GHz	Power @ 1 GHz
1 piece price shown. See web or call for volume pricing.					0.047" dia.	22 dB/100ft	130 W
12"	24"	36"	48"		60"	72"	Custom Len.
\$62.50	\$69.92	\$77.35	\$85.21	\$87.57	\$94.43		See Web

SMA MALE TO SMP FEMALE RIGHT ANGLE



Standard Formable Cable Assemblies

Part No. PE3W06701					Cable Dia.	Attn. @ 1 GHz	Power @ 1 GHz
1 piece price shown. See web or call for volume pricing.					0.105" dia.	20 dB/100ft	122 W
12"	24"	36"	48"		60"	50CM	Custom Len.
\$68.05	\$77.00	\$85.96	\$94.91	\$103.87	\$73.79		See Web

Part No. PE3C3028					Cable Dia.	Attn. @ 1 GHz	Power @ 1 GHz
1 piece price shown. See web or call for volume pricing.					0.098" dia.	38 dB/100ft	160 W
12"	24"	36"	48"		60"	50CM	Custom Len.
\$51.60	\$54.63	\$57.66	\$60.70	\$63.72	\$53.54		See Web

Part No. PE3W05274					Cable Dia.	Attn. @ 1 GHz	Power @ 1 GHz
1 piece price shown. See web or call for volume pricing.					0.098" dia.	58 dB/100ft	160 W
12"	24"	36"	48"		60"	50CM	Custom Len.
\$46.07	\$60.17	\$63.45	\$66.73	\$70.02	\$58.99		See Web

SMA MALE TO SSMA MALE



Low Loss Flexible Cable Assemblies

Part No. PE3W01283					Cable Dia.	Attn. @ 1 GHz	Power @ 1 GHz
1 piece price shown. See web or call for volume pricing.					0.109" dia.	dB/100ft	W
12"	24"	36"	48"		60"	50CM	Custom Len.
\$48.96	\$50.25	\$51.53	\$52.82	\$54.11	\$49.78		See Web

Part No. PE35430					Cable Dia.	Attn. @ 1 GHz	Power @ 1 GHz
1 piece price shown. See web or call for volume pricing.					0.100" dia.	32 dB/100ft	16 W
6"	12"	18"	24"		36"	48"	Custom Len.
\$62.85	\$57.39	\$57.61	\$57.84	\$58.28	\$58.70		See Web

Part No. PE3058					Cable Dia.	Attn. @ 1 GHz	Power @ 1 GHz
1 piece price shown. See web or call for volume pricing.					0.072" dia.	44 dB/100ft	55 W
6"	12"	18"	24"		36"	48"	Custom Len.
\$69.63	\$66.17	\$66.66	\$67.14	\$72.26	\$73.38		See Web

Part No. PE3669					Cable Dia.	Attn. @ 1 GHz	Power @ 1 GHz
1 piece price shown. See web or call for volume pricing.					0.098" dia.	58 dB/100ft	160 W
6"	12"	18"	24"		36"	48"	Custom Len.
\$63.47	\$64.99	\$66.56	\$63.06	\$65.95	\$68.84		See Web

Part No. PE37401					Cable Dia.	Attn. @ 1 GHz	Power @ 1 GHz
1 piece price shown. See web or call for volume pricing.					0.114" dia.	26 dB/100ft	160 W
12"	24"	36"	48"		60"		Custom Len.
\$63.82	\$66.94	\$64.90	\$67.82	\$70.72	-		See Web

SMA MALE TO SSMC PLUG



Low Loss Flexible Cable Assemblies

Part No. PE3C4422					Cable Dia.	Attn. @ 1 GHz	Power @ 1 GHz
1 piece price shown. See web or call for volume pricing.					0.110" dia.	24 dB/100ft	W
6"	12"	18"	24"		36"	48"	Custom Len.
\$49.61	\$49.98	\$45.80	\$46.17	\$51.50	\$47.64		See Web

Part No. PE3C4444					Cable Dia.	Attn. @ 1 GHz	Power @ 1 GHz
1 piece price shown. See web or call for volume pricing.					0.105" dia.	20 dB/100ft	122 W
6"	12"	18"	24"		36"	48"	Custom Len.
\$61.70	\$65.84	\$70.11	\$74.38	\$74.90	\$82.42		See Web

Part No. PE3C4391					Cable Dia.	Attn. @ 1 GHz	Power @ 1 GHz
1 piece price shown. See web or call for volume pricing.					0.072" dia.	44 dB/100ft	55 W
6"	12"	18"	24"		36"	48"	Custom Len.
\$64.58	\$71.57	\$72.45	\$72.71	\$73.84	\$74.97		See Web

Part No. PE3W06410					Cable Dia.	Attn. @ 1 GHz	Power @ 1 GHz
1 piece price shown. See web or call for volume pricing.					0.080" dia.	49 dB/100ft	78 W
12"	24"	36"	48"		60"	50CM	Custom Len.
\$65.98	\$67.46	\$68.95	\$70.43	\$71.92	\$66.92		See Web

Part No. PE3C4405					Cable Dia.	Attn. @ 1 GHz	Power @ 1 GHz
1 piece price shown. See web or call for volume pricing.					0.098" dia.	58 dB/100ft	160 W
6"	12"	18"	24"		36"	48"	Custom Len.
\$55.64	\$57.05	\$62.04	\$59.85	\$62.66	\$65.45		See Web

SMA MALE TO SSMC PLUG RIGHT ANGLE



Low Loss Flexible Cable Assemblies

Part No. PE3C4423					Cable Dia.	Attn. @ 1 GHz	Power @ 1 GHz
1 piece price shown. See web or call for volume pricing.					0.110" dia.	24 dB/100ft	W
6"	12"	18"	24"		36"	48"	Custom Len.
\$44.15	\$44.52	\$44.90	\$42.73	\$43.47	\$46.84		See Web

Part No. PE3C4484					Cable Dia.	Attn. @ 1 GHz	Power @ 1 GHz
1 piece price shown. See web or call for volume pricing.					0.105" dia.	20 dB/100ft	122 W
6"	12"	18"	24"		36"	48"	Custom Len.
\$52.99	\$56.76	\$60.52	\$64.28	\$79.51	\$79.33		See Web

Part No. PE3C4463					Cable Dia.	Attn. @ 1 GHz	Power @ 1 GHz
1 piece price shown. See web or call for volume pricing.					0.072" dia.	44 dB/100ft	55 W
6"	18"	36"	12"		24"	48"	Custom Len.
\$56.17	\$57.11	\$58.51	\$56.65	\$57.58	\$59.44		See Web

Part No. PE3C4406					Cable Dia.	Attn. @ 1 GHz	Power @ 1 GHz
1 piece price shown. See web or call for volume pricing.					0.098" dia.	58 dB/100ft	160 W
6"	12"	18"	24"		36"	48"	Custom Len.
\$50.10	\$51.45	\$52.80	\$54.13	\$56.83	\$59.51		See Web

Part No. PE3C4471					Cable Dia.	Attn. @ 1 GHz	Power @ 1 GHz
1 piece price shown. See web or call for volume pricing.					0.114" dia.	9 dB/100ft	85 W
6"	12"	18"	24"		36"	48"	Custom Len.
\$47.15	\$48.57	\$54.99	\$51.40	\$54.23	\$57.05		See Web

SMA MALE TO SSMC JACK



Standard Flexible Cable Assemblies

Part No. PE3C4471					Cable Dia.	Attn. @ 1 GHz	Power @ 1 GHz
1 piece price shown. See web or call for volume pricing.					0.114" dia.	9 dB/100ft	85 W
6"	12"	18"	24"		36"	48"	Custom Len.
\$47.15	\$48.57	\$54.99	\$51.40	\$54.23	\$57.05		See Web

Continued on Next Page

For Custom Lengths, Metric Lengths or Special Configurations, Please call (949) 261-1920

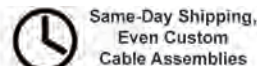
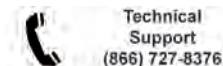

Cable Assemblies

See Our Website For Current Pricing & Real-Time Stock Availability!

For our complete selection of cable assemblies, please visit our website

Part No.	Cable Dia.				Attn. @ 1 GHz	Power @ 1 GHz
PE3W04458	1 piece price shown. See web or call for volume pricing.				0.114" dia.	9 dB/100ft
12"	24"	36"	48"	60"	50CM	Custom Len.
\$51.97	\$55.21	\$58.46	\$61.72	\$64.97	\$54.05	See Web
SMA MALE TO SSMC JACK BULKHEAD						
SEE MOUNTING HOLE SECTION ON PAGE 369						
Standard Formable Cable Assemblies						
PE-SR405FLJ Coax, 50 Ohm						
Part No. PE3C4445	1 piece price shown. See web or call for volume pricing.				0.105" dia.	20 dB/100ft
6"	12"	18"	24"	36"	48"	Custom Len.
\$49.27	\$53.03	\$56.80	\$60.55	\$68.09	\$75.61	See Web
Standard Flexible Cable Assemblies						
RG178B/U Coax, 50 Ohm						
Part No. PE3C4392	1 piece price shown. See web or call for volume pricing.				0.072" dia.	44 dB/100ft
6"	12"	18"	24"	36"	48"	Custom Len.
\$60.62	\$61.08	\$61.55	\$62.02	\$62.95	\$63.88	See Web
SMA MALE TO TNC MALE						
Low Loss Flexible Cable Assemblies						
PE-C195 Coax, 50 Ohm						
Part No. PE36058	1 piece price shown. See web or call for volume pricing.				0.195" dia.	11 dB/100ft
12"	24"	36"	48"	60"	-	Custom Len.
\$38.66	\$39.44	\$40.22	\$37.94	\$38.65	-	See Web
PE-C240 Coax, 50 Ohm						
Part No. PE38642	1 piece price shown. See web or call for volume pricing.				0.240" dia.	9 dB/100ft
12"	24"	36"	48"	60"	-	Custom Len.
\$47.48	\$48.45	\$49.59	\$52.36	\$55.18	-	See Web
LMR-100A-PVC Coax, 50 Ohm						
Part No. PE3C0114	1 piece price shown. See web or call for volume pricing.				0.110" dia.	24 dB/100ft
12"	24"	36"	48"	60"	-	Custom Len.
\$53.72	\$54.47	\$52.19	\$52.96	\$56.81	-	See Web
LMR-195 Coax, 50 Ohm						
Part No. PE3C4164	1 piece price shown. See web or call for volume pricing.				0.195" dia.	12 dB/100ft
12"	24"	36"	48"	60"	-	Custom Len.
\$52.98	\$53.71	\$54.43	\$55.16	\$55.89	-	See Web
PE-P142LL Coax, 50 Ohm						
Part No. PE3C0847	1 piece price shown. See web or call for volume pricing.				0.195" dia.	7 dB/100ft
12"	24"	36"	48"	60"	50CM	Custom Len.
\$144.38	\$160.62	\$176.86	\$193.09	\$209.33	\$154.78	See Web
PE-P142LL-2748 Coax, 50 Ohm						
Part No. PE3M0129	1 piece price shown. See web or call for volume pricing.				0.195" dia.	dB/100ft
12"	18"	24"	36"	48"	60"	Custom Len.
\$367.28	\$375.75	\$384.23	\$401.19	\$418.15	\$435.10	See Web
PE-P160LL-2748 Coax, 50 Ohm						
Part No. PE3M0183	1 piece price shown. See web or call for volume pricing.				0.160" dia.	dB/100ft
8"	12"	18"	24"	30"	36"	Custom Len.
\$353.68	\$358.58	\$365.93	\$373.28	\$380.63	\$387.98	See Web
PE-P300LL-2748 Coax, 50 Ohm						
Part No. PE3M0227	1 piece price shown. See web or call for volume pricing.				0.300" dia.	dB/100ft
12"	18"	24"	36"	48"	60"	Custom Len.
\$401.44	\$415.59	\$429.74	\$458.04	\$486.35	\$514.65	See Web
PE-P160LL Coax, 50 Ohm						
Part No. PE3C5258	1 piece price shown. See web or call for volume pricing.				0.160" dia.	dB/100ft
12"	24"	36"	48"	60"	50CM	Custom Len.
\$205.44	\$226.16	\$246.87	\$267.58	\$288.29	\$218.71	See Web
Low Loss Test Flexible Cable Assemblies						
PE-P300LL Coax, 50 Ohm						
Part No. PE3C3242	1 piece price shown. See web or call for volume pricing.				0.300" dia.	6 dB/100ft
12"	24"	36"	48"	60"	50CM	Custom Len.
\$218.25	\$243.46	\$268.66	\$293.87	\$319.07	\$234.40	See Web
PE-P300LL Coax, 50 Ohm						
Part No. PE338	1 piece price shown. See web or call for volume pricing.				0.300" dia.	6 dB/100ft
12"	24"	48"	60"	50CM	100CM	Custom Len.
\$275.40	\$301.33	\$353.22	\$379.14	\$292.02	\$334.56	See Web
Standard Formable Cable Assemblies						
PE-SR401FL Coax, 50 Ohm						

Part No.	Cable Dia.				Attn. @ 1 GHz	Power @ 1 GHz
PE34422	1 piece price shown. See web or call for volume pricing.				* dia.	8 dB/100ft
6"	12"	18"	24"	36"	48"	Custom Len.
\$155.30	\$163.23	\$161.69	\$169.39	\$184.78	\$200.18	See Web
PE-SR402FL Coax, 50 Ohm						
Part No. PE33928	1 piece price shown. See web or call for volume pricing.				* dia.	12 dB/100ft
6"	12"	18"	24"	36"	48"	Custom Len.
\$78.64	\$78.64	\$82.82	\$87.00	\$95.35	\$103.70	See Web
PE-SR405FL Coax, 50 Ohm						
Part No. PE34416	1 piece price shown. See web or call for volume pricing.				* dia.	23 dB/100ft
6"	12"	18"	24"	36"	48"	Custom Len.
\$68.36	\$68.39	\$73.60	\$78.77	\$89.15	\$99.55	See Web
Standard Flexible Cable Assemblies						
RG8A/U Coax, 50 Ohm						
Part No. PE33669	1 piece price shown. See web or call for volume pricing.				0.405" dia.	8 dB/100ft
12"	24"	36"	48"	60"	-	Custom Len.
\$112.61	\$115.18	\$125.51	\$120.42	\$123.05	-	See Web
RG58C/U Coax, 50 Ohm						
Part No. PE3154	1 piece price shown. See web or call for volume pricing.				0.195" dia.	20 dB/100ft
12"	24"	36"	48"	60"	72"	Custom Len.
\$42.15	\$42.96	\$43.77	\$44.64	\$45.47	\$46.30	See Web
RG141A/U Coax, 50 Ohm						
Part No. PE37580	1 piece price shown. See web or call for volume pricing.				0.190" dia.	13 dB/100ft
12"	24"	36"	48"	60"	-	Custom Len.
\$48.22	\$54.15	\$60.11	\$66.04	\$72.03	-	See Web
RG142B/U Coax, 50 Ohm						
Part No. PE3664	1 piece price shown. See web or call for volume pricing.				0.195" dia.	13 dB/100ft
12"	24"	36"	48"	60"	72"	Custom Len.
\$45.46	\$54.27	\$60.35	\$66.78	\$72.97	\$74.12	See Web
RG174A/U Coax, 50 Ohm						
Part No. PE3178	1 piece price shown. See web or call for volume pricing.				0.110" dia.	32 dB/100ft
12"	24"	36"	48"	60"	72"	Custom Len.
\$56.45	\$53.69	\$57.60	\$54.55	\$54.98	\$59.39	See Web
RG178B/U Coax, 50 Ohm						
Part No. PE34248	1 piece price shown. See web or call for volume pricing.				0.072" dia.	44 dB/100ft
12"	24"	36"	48"	60"	72"	Custom Len.
\$70.25	\$71.31	\$68.18	\$69.15	\$70.09	\$71.06	See Web
RG188A/U Coax, 50 Ohm						
Part No. PE33361	1 piece price shown. See web or call for volume pricing.				0.110" dia.	26 dB/100ft
12"	24"	36"	48"	60"	72"	Custom Len.
\$55.08	\$57.30	\$59.51	\$61.74	\$63.96	\$66.17	See Web
RG213/U Coax, 50 Ohm						
Part No. PE33673	1 piece price shown. See web or call for volume pricing.				0.405" dia.	8 dB/100ft
12"	24"	36"	48"	60"	72"	Custom Len.
\$125.36	\$127.01	\$128.68	\$130.33	\$132.00	\$133.66	See Web
RG214/U Coax, 50 Ohm						
Part No. PE3176	1 piece price shown. See web or call for volume pricing.				0.425" dia.	7 dB/100ft
12"	24"	36"	48"	60"	72"	Custom Len.
\$139.80	\$147.12	\$154.46	\$161.77	\$169.10	\$176.43	See Web
RG223/U Coax, 50 Ohm						
Part No. PE3535	1 piece price shown. See web or call for volume pricing.				0.210" dia.	13 dB/100ft
12"	24"	36"	48"	60"	72"	Custom Len.
\$46.07	\$49.19	\$52.29	\$55.60	\$55.07	\$61.95	See Web
RG316/U Coax, 50 Ohm						
Part No. PE3174	1 piece price shown. See web or call for volume pricing.				0.102" dia.	38 dB/100ft
12"	24"	36"	48"	60"	72"	Custom Len.
\$60.50	\$63.63	\$66.76	\$70.06	\$73.25	\$76.43	See Web
RG316-DS Coax, 50 Ohm						
Part No. PE34246	1 piece price shown. See web or call for volume pricing.				0.114" dia.	26 dB/100ft
12"	24"	36"	48"	60"	72"	Custom Len.
\$50.19	\$53.11	\$56.02	\$58.92	\$61.83	\$71.14	See Web
RG400/U Coax, 50 Ohm						
Part No. PE33948	1 piece price shown. See web or call for volume pricing.				0.195" dia.	15 dB/100ft
12"	24"	36"	48"	60"	72"	Custom Len.
\$57.82	\$65.22	\$72.61	\$80.44	\$87.97	\$89.40	See Web
PE-P195 Coax, 50 Ohm						
Part No. PE33396	1 piece price shown. See web or call for volume pricing.				0.195" dia.	13 dB/100ft
12"	24"	36"	48"	60"	-	Custom Len.
\$47.87	\$56.73	\$69.89	\$74.42	\$89.79	-	See Web

Cable Assemblies
See Our Website For Current Pricing & Real-Time Stock Availability!

*Coax Performance at 1 GHz Notes: Cable assembly max frequency may be lower than connector or coax max frequency

For our complete selection of cable assemblies, please visit our website

Standard Semi-Rigid Cable Assemblies						
PE-047SR Coax, 50 Ohm						
Part No. PE34408	Cable Dia.		Attn. @ 1 GHz	Power @ 1 GHz		
1 piece price shown. See web or call for volume pricing.						
6"	12"	18"	24"	36"	48"	Custom Len.
\$80.56	\$85.54	\$90.52	\$95.45	\$105.41	\$115.32	See Web
PE-SR402AL Coax, 50 Ohm						
Part No. PE34406	Cable Dia.		Attn. @ 1 GHz	Power @ 1 GHz		
1 piece price shown. See web or call for volume pricing.						
0.141" dia.						
6"	12"	18"	24"	36"	48"	Custom Len.
\$69.83	\$74.77	\$75.10	\$79.67	\$88.78	\$97.90	See Web
PE-SR405AL Coax, 50 Ohm						
Part No. PE34414	Cable Dia.		Attn. @ 1 GHz	Power @ 1 GHz		
1 piece price shown. See web or call for volume pricing.						
" dia.						
6"	12"	18"	24"	36"	48"	Custom Len.
\$62.20	\$66.40	\$70.59	\$74.74	\$83.15	\$91.48	See Web
RG401/U Coax, 50 Ohm						
Part No. PE34418	Cable Dia.		Attn. @ 1 GHz	Power @ 1 GHz		
1 piece price shown. See web or call for volume pricing.						
" dia.						
6"	12"	18"	24"	36"	48"	Custom Len.
\$149.73	\$160.73	\$162.25	\$172.93	\$194.24	\$215.48	See Web
RG402/U Coax, 50 Ohm						
Part No. PE3089	Cable Dia.		Attn. @ 1 GHz	Power @ 1 GHz		
1 piece price shown. See web or call for volume pricing.						
" dia.						
6"	12"	18"	24"	36"	48"	Custom Len.
\$71.25	\$71.25	\$74.90	\$78.55	\$85.86	\$93.17	See Web
RG405/U Coax, 50 Ohm						
Part No. PE33420	Cable Dia.		Attn. @ 1 GHz	Power @ 1 GHz		
1 piece price shown. See web or call for volume pricing.						
" dia.						
6"	12"	18"	24"	36"	48"	Custom Len.
\$69.83	\$69.83	\$77.74	\$76.71	\$83.58	\$90.44	See Web
PE-SR401AL-STRAIGHT Coax, 50 Ohm						
Part No. PE34420	Cable Dia.		Attn. @ 1 GHz	Power @ 1 GHz		
1 piece price shown. See web or call for volume pricing.						
0.250" dia.						
6"	12"	18"	24"	36"	48"	Custom Len.
\$161.01	\$156.79	\$165.86	\$174.93	\$193.07	\$211.22	See Web
Standard Flexible Cable Assemblies						
RG55B/U Coax, 53 Ohm						
Part No. PE34250	Cable Dia.		Attn. @ 1 GHz	Power @ 1 GHz		
1 piece price shown. See web or call for volume pricing.						
0.202" dia.						
12"	24"	36"	48"	60"	72"	Custom Len.
\$42.61	\$44.84	\$47.09	\$49.33	\$51.58	\$53.81	See Web
RG59B/U Coax, 75 Ohm						
Part No. PE36848	Cable Dia.		Attn. @ 1 GHz	Power @ 1 GHz		
1 piece price shown. See web or call for volume pricing.						
0.242" dia.						
12"	24"	36"	48"	60"	-	Custom Len.
\$48.64	\$49.59	\$52.66	\$51.50	\$52.47	-	See Web
SMA MALE TO TNC MALE RIGHT ANGLE						
Low Loss Flexible Cable Assemblies						
PE-P142LL Coax, 50 Ohm						
Part No. PE3C0780	Cable Dia.		Attn. @ 1 GHz	Power @ 1 GHz		
1 piece price shown. See web or call for volume pricing.						
0.195" dia.						
12"	24"	36"	48"	60"	50CM	Custom Len.
\$225.01	\$241.25	\$257.47	\$273.71	\$289.95	\$235.42	See Web
PE-P142LL-27478 Coax, 50 Ohm						
Part No. PE3M0131	Cable Dia.		Attn. @ 1 GHz	Power @ 1 GHz		
1 piece price shown. See web or call for volume pricing.						
0.195" dia.						
12"	18"	24"	36"	48"	60"	Custom Len.
\$473.95	\$482.43	\$490.91	\$507.86	\$524.82	\$541.78	See Web
PE-P160LL-27478 Coax, 50 Ohm						
Part No. PE3M0185	Cable Dia.		Attn. @ 1 GHz	Power @ 1 GHz		
1 piece price shown. See web or call for volume pricing.						
0.160" dia.						
8"	12"	18"	24"	30"	36"	Custom Len.
\$438.69	\$443.59	\$450.94	\$458.29	\$465.64	\$472.99	See Web
PE-P300LL-27478 Coax, 50 Ohm						
Part No. PE3M0228	Cable Dia.		Attn. @ 1 GHz	Power @ 1 GHz		
1 piece price shown. See web or call for volume pricing.						
0.300" dia.						
12"	18"	24"	36"	48"	60"	Custom Len.
\$545.72	\$559.88	\$574.03	\$602.33	\$630.63	\$658.93	See Web
PE-P160LL Coax, 50 Ohm						
Part No. PE3C5259	Cable Dia.		Attn. @ 1 GHz	Power @ 1 GHz		
1 piece price shown. See web or call for volume pricing.						
0.160" dia.						
12"	24"	36"	48"	60"	50CM	Custom Len.
\$264.21	\$284.92	\$305.63	\$326.35	\$347.06	\$277.48	See Web
Standard Formable Cable Assemblies						
PE-SR405FLJ Coax, 50 Ohm						
Part No. PE3W07181	Cable Dia.		Attn. @ 1 GHz	Power @ 1 GHz		
1 piece price shown. See web or call for volume pricing.						
0.105" dia.						
12"	24"	36"	48"	60"	50CM	Custom Len.
\$49.04	\$57.99	\$66.94	\$75.90	\$84.86	\$54.78	See Web

SMA MALE TO TNC FEMALE						
Flexible Cable Assemblies						
LMR-195-FR Coax, 50 Ohm						
Part No. PE3C5480	Cable Dia.		Attn. @ 1 GHz	Power @ 1 GHz		
1 piece price shown. See web or call for volume pricing.						
0.195" dia.						
12"	24"	36"	48"	60"	50CM	Custom Len.
\$37.03	\$38.04	\$39.05	\$40.05	\$41.06	\$37.67	See Web
SMA MALE TO TNC FEMALE BULKHEAD						
SEE MOUNTING HOLE SECTION ON PAGE 369						
Precision Formable Cable Assemblies						
PE-SR405FL Coax, 50 Ohm						
Part No. PE39475	Cable Dia.		Attn. @ 1 GHz	Power @ 1 GHz		
1 piece price shown. See web or call for volume pricing.						
" dia.						
6"	9"	12"	18"	24"	-	Custom Len.
\$52.06	\$49.31	\$52.06	\$57.86	\$63.66	-	See Web
PE-SR405FLJ Coax, 50 Ohm						
Part No. PE39489	Cable Dia.		Attn. @ 1 GHz	Power @ 1 GHz		
1 piece price shown. See web or call for volume pricing.						
0.098" dia.						
6"	9"	12"	18"	24"	-	Custom Len.
\$47.86	\$45.14	\$47.86	\$52.34	\$56.83	-	See Web
Low Loss Flexible Cable Assemblies						
PE-P142LL Coax, 50 Ohm						
Part No. PE3C2449	Cable Dia.		Attn. @ 1 GHz	Power @ 1 GHz		
1 piece price shown. See web or call for volume pricing.						
0.195" dia.						
12"	24"	36"	48"	60"	50CM	Custom Len.
\$178.75	\$194.99	\$211.22	\$227.46	\$243.70	\$189.15	See Web
PE-P142LL-27478 Coax, 50 Ohm						
Part No. PE3M0130	Cable Dia.		Attn. @ 1 GHz	Power @ 1 GHz		
1 piece price shown. See web or call for volume pricing.						
0.195" dia.						
12"	18"	24"	36"	48"	60"	Custom Len.
\$446.13	\$454.60	\$463.08	\$480.04	\$497.00	\$513.95	See Web
PE-P160LL-27478 Coax, 50 Ohm						
Part No. PE3M0184	Cable Dia.		Attn. @ 1 GHz	Power @ 1 GHz		
1 piece price shown. See web or call for volume pricing.						
0.160" dia.						
8"	12"	18"	24"	30"	36"	Custom Len.
\$434.75	\$439.65	\$447.00	\$454.35	\$461.70	\$469.06	See Web
PE-P160LL Coax, 50 Ohm						
Part No. PE3C5260	Cable Dia.		Attn. @ 1 GHz	Power @ 1 GHz		
1 piece price shown. See web or call for volume pricing.						
0.160" dia.						
12"	24"	36"	48"	60"	50CM	Custom Len.
\$231.73	\$252.45	\$273.15	\$293.87	\$314.58	\$245.00	See Web
Standard Formable Cable Assemblies						
PE-SR402FL Coax, 50 Ohm						
Part No. PE39483	Cable Dia.		Attn. @ 1 GHz	Power @ 1 GHz		
1 piece price shown. See web or call for volume pricing.						
" dia.						
6"	9"	12"	18"	24"	-	Custom Len.
\$48.25	\$45.52	\$48.25	\$52.43	\$56.60	-	See Web
PE-SR402FLJ Coax, 50 Ohm						
Part No. PE39497	Cable Dia.		Attn. @ 1 GHz	Power @ 1 GHz		
1 piece price shown. See web or call for volume pricing.						
0.161" dia.						
6"	9"	12"	18"	24"	-	Custom Len.
\$54.74	\$51.64	\$54.74	\$59.23	\$63.72	-	See Web
Standard Flexible Cable Assemblies						
RG316/U Coax, 50 Ohm						
Part No. PE3W05224	Cable Dia.		Attn. @ 1 GHz	Power @ 1 GHz		
1 piece price shown. See web or call for volume pricing.						
0.098" dia.						
12"	24"	36"	48"	60"	50CM	Custom Len.
\$54.19	\$57.47	\$60.75	\$64.03	\$67.32	\$56.29	See Web
SMA MALE TO REVERSE POLARITY TNC MALE						
Low Loss Flexible Cable Assemblies						
PE-C195 Coax, 50 Ohm						
Part No. PE37120	Cable Dia.		Attn. @ 1 GHz	Power @ 1 GHz		
1 piece price shown. See web or call for volume pricing.						
0.195" dia.						
12"	24"	36"	48"	60"	-	Custom Len.
\$43.24	\$40.02	\$40.74	\$41.45	\$46.43	-	See Web
Standard Flexible Cable Assemblies						
RG58C/U Coax, 50 Ohm						
Part No. PE34853	Cable Dia.		Attn. @ 1 GHz	Power @ 1 GHz		
1 piece price shown. See web or call for volume pricing.						
0.195" dia.						
12"	24"	36"	48"	60"	72"	Custom Len.
\$45.91	\$46.64	\$47.38	\$48.12	\$48.85	\$49.59	See Web
RG142B/U Coax, 50 Ohm						

Cable Assemblies

See Our Website For Current Pricing & Real-Time Stock Availability!

Continued on Next Page

For Custom Lengths, Metric Lengths or Special Configurations, Please call (949) 261-1920

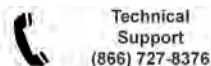

Technical Support
(866) 727-8376



Same-Day Shipping,
Even Custom Cable Assemblies

For our complete selection of cable assemblies, please visit our website

Part No. PE34854	Cable Dia.	Attn. @ 1 GHz	Power @ 1 GHz				
1 piece price shown. See web or call for volume pricing.	0.195" dia.	13 dB/100ft	650 W				
12" 24" 36" 48"	60" 72"	Custom Len.					
\$46.89 \$56.72 \$62.80 \$64.09	\$75.43	\$75.56	See Web				
RG223/U Coax, 50 Ohm							
Part No. PE34397	Cable Dia.	Attn. @ 1 GHz	Power @ 1 GHz				
1 piece price shown. See web or call for volume pricing.	0.210" dia.	13 dB/100ft	53 W				
12" 24" 36" 48"	60" 72"	Custom Len.					
\$43.99 \$46.89 \$49.79 \$52.69	\$55.59	\$58.49	See Web				
RG316/U Coax, 50 Ohm							
Part No. PE34396	Cable Dia.	Attn. @ 1 GHz	Power @ 1 GHz				
1 piece price shown. See web or call for volume pricing.	0.098" dia.	38 dB/100ft	160 W				
12" 24" 36" 48"	60" 72"	Custom Len.					
\$53.44 \$60.83 \$63.96 \$62.43	\$65.43	\$68.44	See Web				
SMA MALE TO HMCX32 1.2 PLUG							
Standard Flexible Cable Assemblies							
PE-81mm Coax, 50 Ohm							
Part No. PE3CA1030	Cable Dia.	Attn. @ 1 GHz	Power @ 1 GHz				
1 piece price shown. See web or call for volume pricing.	0.032" dia.	dB/100ft	W				
3" 6" 12" -	-	24"	Custom Len.				
\$11.21 \$12.93 \$12.93	-	-	See Web				
SMA MALE TO UMCX PLUG							
Standard Flexible Cable Assemblies							
RG178B/U Coax, 50 Ohm							
Part No. PE38881	Cable Dia.	Attn. @ 1 GHz	Power @ 1 GHz				
1 piece price shown. See web or call for volume pricing.	0.072" dia.	dB/100ft	W				
3" 6" 9" 12"	18" 24"	Custom Len.					
\$65.24 \$66.95 \$68.67 \$70.38	\$73.91	\$77.44	See Web				
SMA MALE TO UMCX 2.1 PLUG							
Standard Flexible Cable Assemblies							
PE-81mm Coax, 50 Ohm							
Part No. PE3CA1028	Cable Dia.	Attn. @ 1 GHz	Power @ 1 GHz				
1 piece price shown. See web or call for volume pricing.	0.032" dia.	dB/100ft	W				
3" 6" 12" -	-	24"	Custom Len.				
\$12.93 \$14.57 \$12.93	-	-	See Web				
SMA MALE TO UMCX 2.5 PLUG							
Standard Flexible Cable Assemblies							
RG178B/U Coax, 50 Ohm							
Part No. PE3CA1026	Cable Dia.	Attn. @ 1 GHz	Power @ 1 GHz				
1 piece price shown. See web or call for volume pricing.	0.070" dia.	dB/100ft	W				
6" 9" 12" -	-	Custom Len.					
\$11.21 \$12.93 \$12.93	-	-	See Web				
RG178-DS Coax, 50 Ohm							
Part No. PE3CA1027	Cable Dia.	Attn. @ 1 GHz	Power @ 1 GHz				
1 piece price shown. See web or call for volume pricing.	0.086" dia.	dB/100ft	W				
3" 6" 9" 12"	-	Custom Len.					
\$11.21 \$14.05 \$11.21 \$14.05	-	-	See Web				
PE-81mm Coax, 50 Ohm							
Part No. PE3CA1023	Cable Dia.	Attn. @ 1 GHz	Power @ 1 GHz				
1 piece price shown. See web or call for volume pricing.	0.032" dia.	dB/100ft	W				
3" 6" 12" -	-	Custom Len.					
\$12.93 \$11.21 \$14.57	-	-	See Web				
PE-113mm Coax, 50 Ohm							
Part No. PE3CA1024	Cable Dia.	Attn. @ 1 GHz	Power @ 1 GHz				
1 piece price shown. See web or call for volume pricing.	0.044" dia.	dB/100ft	W				
3" 6" 12" 18"	-	Custom Len.					
\$12.93 \$12.93 \$12.93 \$12.25	-	-	See Web				
PE-137mm Coax, 50 Ohm							
Part No. PE3CA1025	Cable Dia.	Attn. @ 1 GHz	Power @ 1 GHz				
1 piece price shown. See web or call for volume pricing.	0.053" dia.	dB/100ft	W				
3" 6" 12" -	-	Custom Len.					
\$14.57 \$12.93 \$12.93	-	-	See Web				
SMA MALE TO WMCX 1.6 PLUG							
Standard Flexible Cable Assemblies							
PE-81mm Coax, 50 Ohm							

Part No. PE3CA1029	Cable Dia.	Attn. @ 1 GHz	Power @ 1 GHz				
1 piece price shown. See web or call for volume pricing.	0.032" dia.	dB/100ft	W				
3" 6" 12" -	-	Custom Len.					
\$12.93 \$12.93 \$12.93	-	-	See Web				
REVERSE POLARITY SMA MALE TO BNC MALE							
Standard Flexible Cable Assemblies							
RG58C/U Coax, 50 Ohm							
Part No. PE35207	Cable Dia.	Attn. @ 1 GHz	Power @ 1 GHz				
1 piece price shown. See web or call for volume pricing.	0.195" dia.	20 dB/100ft	44 W				
12" 24" 36" 48"	60" 72"	Custom Len.					
\$50.45 \$55.31 \$56.12 \$52.67	\$53.40	\$54.13	See Web				
RG142B/U Coax, 50 Ohm							
Part No. PE35209	Cable Dia.	Attn. @ 1 GHz	Power @ 1 GHz				
1 piece price shown. See web or call for volume pricing.	0.195" dia.	13 dB/100ft	650 W				
12" 24" 36" 48"	60" 72"	Custom Len.					
\$46.37 \$52.11 \$57.84 \$68.67	\$69.29	\$75.04	See Web				
RG174A/U Coax, 50 Ohm							
Part No. PE3C3332	Cable Dia.	Attn. @ 1 GHz	Power @ 1 GHz				
1 piece price shown. See web or call for volume pricing.	0.110" dia.	32 dB/100ft	17 W				
12" 24" 36" 48"	60" 72"	Custom Len.					
\$43.05 \$47.93 \$43.86 \$44.32	\$44.73	\$45.19	See Web				
RG178B/U Coax, 50 Ohm							
Part No. PE35213	Cable Dia.	Attn. @ 1 GHz	Power @ 1 GHz				
1 piece price shown. See web or call for volume pricing.	0.072" dia.	44 dB/100ft	78 W				
12" 24" 36" 48"	60" 72"	Custom Len.					
\$68.74 \$69.71 \$70.65 \$71.62	\$77.19	\$73.54	See Web				
RG188A/U Coax, 50 Ohm							
Part No. PE3C3412	Cable Dia.	Attn. @ 1 GHz	Power @ 1 GHz				
1 piece price shown. See web or call for volume pricing.	0.110" dia.	26 dB/100ft	160 W				
12" 24" 36" 48"	60" 72"	Custom Len.					
\$44.68 \$46.69 \$48.77 \$50.85	\$52.87	\$54.95	See Web				
RG223/U Coax, 50 Ohm							
Part No. PE35217	Cable Dia.	Attn. @ 1 GHz	Power @ 1 GHz				
1 piece price shown. See web or call for volume pricing.	0.210" dia.	13 dB/100ft	53 W				
12" 24" 36" 48"	60" 72"	Custom Len.					
\$46.12 \$46.42 \$52.36 \$52.22	\$55.11	\$58.02	See Web				
RG316/U Coax, 50 Ohm							
Part No. PE3C3413	Cable Dia.	Attn. @ 1 GHz	Power @ 1 GHz				
1 piece price shown. See web or call for volume pricing.	0.102" dia.	38 dB/100ft	160 W				
12" 24" 36" 48"	60" 72"	Custom Len.					
\$45.48 \$53.14 \$56.27 \$54.13	\$57.03	\$59.92	See Web				
REVERSE POLARITY SMA MALE TO MCX PLUG RIGHT ANGLE							
Standard Flexible Cable Assemblies							
RG316/U Coax, 50 Ohm							
Part No. PE3C0481	Cable Dia.	Attn. @ 1 GHz	Power @ 1 GHz				
1 piece price shown. See web or call for volume pricing.	0.098" dia.	38 dB/100ft	160 W				
12" 24" 36" 48"	60" 72"	Custom Len.					
\$58.03 \$61.16 \$60.52 \$63.40	\$70.78	\$69.19	See Web				
REVERSE POLARITY SMA MALE TO N MALE							
Low Loss Flexible Cable Assemblies							
PE-C195 Coax, 50 Ohm							
Part No. PE36072	Cable Dia.	Attn. @ 1 GHz	Power @ 1 GHz				
1 piece price shown. See web or call for volume pricing.	0.195" dia.	11 dB/100ft	150 W				
12" 24" 36" 48"	60" 72"	Custom Len.					
\$48.51 \$49.22 \$49.93 \$50.65	\$51.37	-	See Web				
Standard Flexible Cable Assemblies							
RG58C/U Coax, 50 Ohm							
Part No. PE34727	Cable Dia.	Attn. @ 1 GHz	Power @ 1 GHz				
1 piece price shown. See web or call for volume pricing.	0.195" dia.	20 dB/100ft	44 W				
12" 24" 36" 48"	60" 72"	Custom Len.					
\$54.09 \$54.83 \$60.04 \$56.30	\$57.04	\$57.78	See Web				
RG142B/U Coax, 50 Ohm							
Part No. PE34361	Cable Dia.	Attn. @ 1 GHz	Power @ 1 GHz				
1 piece price shown. See web or call for volume pricing.	0.195" dia.	13 dB/100ft	650 W				
12" 24" 36" 48"	60" 72"	Custom Len.					
\$57.23 \$59.71 \$69.38 \$75.82	\$76.91	\$88.21	See Web				
RG174A/U Coax, 50 Ohm							
Part No. PE35221	Cable Dia.	Attn. @ 1 GHz	Power @ 1 GHz				
1 piece price shown. See web or call for volume pricing.	0.100" dia.	32 dB/100ft	16 W				
12" 24" 36" 48"	60" 72"	Custom Len.					
\$55.44 \$60.46 \$56.31 \$56.75	\$57.18	\$57.61	See Web				
RG178B/U Coax, 50 Ohm							

Cable Assemblies See Our Website For Current Pricing & Real-Time Stock Availability!

*Coax Performance at 1 GHz Notes: Cable assembly max frequency may be lower than connector or coax max frequency

For our complete selection of cable assemblies, please visit our website

Part No. PE35223					Cable Dia.	Attn. @ 1 GHz	Power @ 1 GHz	78
1 piece price shown. See web or call for volume pricing.					0.072" dia.	44 dB/100ft	78 W	
12"	24"	36"	48"	60"	72"	Custom Len.		
\$73.72	\$79.20	\$75.65	\$76.61	\$77.56	\$78.52	See Web		
RG188A/U Coax, 50 Ohm								
Part No. PE35225					Cable Dia.	Attn. @ 1 GHz	Power @ 1 GHz	79
1 piece price shown. See web or call for volume pricing.					0.110" dia.	26 dB/100ft	160 W	
12"	24"	36"	48"	60"	72"	Custom Len.		
\$60.68	\$59.45	\$61.68	\$63.89	\$66.11	\$68.34	See Web		
RG223/U Coax, 50 Ohm								
Part No. PE35227					Cable Dia.	Attn. @ 1 GHz	Power @ 1 GHz	80
1 piece price shown. See web or call for volume pricing.					0.210" dia.	13 dB/100ft	53 W	
12"	24"	36"	48"	60"	72"	Custom Len.		
\$51.17	\$54.07	\$56.98	\$63.76	\$66.94	\$65.66	See Web		
RG316/U Coax, 50 Ohm								
Part No. PE34770					Cable Dia.	Attn. @ 1 GHz	Power @ 1 GHz	81
1 piece price shown. See web or call for volume pricing.					0.098" dia.	38 dB/100ft	160 W	
12"	24"	36"	48"	60"	72"	Custom Len.		
\$61.60	\$61.00	\$63.89	\$66.79	\$69.66	\$72.55	See Web		
RG400/U Coax, 50 Ohm								
Part No. PE34323					Cable Dia.	Attn. @ 1 GHz	Power @ 1 GHz	82
1 piece price shown. See web or call for volume pricing.					0.195" dia.	15 dB/100ft	650 W	
12"	24"	36"	48"	60"	-	Custom Len.		
\$61.33	\$64.83	\$76.13	\$78.77	\$91.48	-	See Web		
PE-P195 Coax, 50 Ohm								
Part No. PE35508					Cable Dia.	Attn. @ 1 GHz	Power @ 1 GHz	83
1 piece price shown. See web or call for volume pricing.					0.195" dia.	13 dB/100ft	650 W	
12"	24"	36"	48"	60"	-	Custom Len.		
\$62.05	\$70.91	\$79.76	\$88.61	\$97.47	-	See Web		

REVERSE POLARITY SMA MALE TO N FEMALE BULKHEAD
SEE MOUNTING HOLE SECTION ON PAGE 369



Standard Flexible Cable Assemblies

Part No. PE3W02336					Cable Dia.	Attn. @ 1 GHz	Power @ 1 GHz	84
1 piece price shown. See web or call for volume pricing.					0.195" dia.	20 dB/100ft	80 W	
12"	24"	36"	48"	60"	50CM	Custom Len.		
\$56.18	\$56.96	\$57.74	\$58.53	\$59.31	\$56.68	See Web		
RG142B/U Coax, 50 Ohm								
Part No. PE34575					Cable Dia.	Attn. @ 1 GHz	Power @ 1 GHz	85
1 piece price shown. See web or call for volume pricing.					0.195" dia.	13 dB/100ft	650 W	
12"	24"	36"	48"	60"	-	Custom Len.		
\$58.37	\$64.10	\$69.82	\$75.57	\$81.29	-	See Web		

REVERSE POLARITY SMA MALE TO REVERSE POLARITY SMA MALE



Standard Flexible Cable Assemblies

Part No. PE34750					Cable Dia.	Attn. @ 1 GHz	Power @ 1 GHz	86
1 piece price shown. See web or call for volume pricing.					0.195" dia.	13 dB/100ft	650 W	
12"	18"	24"	36"	48"	60"	Custom Len.		
\$55.66	\$58.70	\$61.74	\$67.82	\$69.20	\$74.77	See Web		

REVERSE POLARITY SMA MALE TO TNC MALE



Standard Flexible Cable Assemblies

Part No. PE35214					Cable Dia.	Attn. @ 1 GHz	Power @ 1 GHz	87
1 piece price shown. See web or call for volume pricing.					0.195" dia.	20 dB/100ft	44 W	
12"	24"	36"	48"	60"	72"	Custom Len.		
\$55.12	\$55.93	\$52.51	\$53.25	\$53.99	\$54.72	See Web		
RG142B/U Coax, 50 Ohm								
Part No. PE35216					Cable Dia.	Attn. @ 1 GHz	Power @ 1 GHz	88
1 piece price shown. See web or call for volume pricing.					0.195" dia.	13 dB/100ft	650 W	
12"	24"	36"	48"	60"	72"	Custom Len.		
\$52.58	\$58.33	\$64.05	\$69.79	\$75.51	\$81.25	See Web		
RG178B/U Coax, 50 Ohm								
Part No. PE35220					Cable Dia.	Attn. @ 1 GHz	Power @ 1 GHz	89
1 piece price shown. See web or call for volume pricing.					0.072" dia.	44 dB/100ft	78 W	
12"	24"	36"	48"	60"	72"	Custom Len.		
\$71.20	\$79.38	\$73.12	\$74.07	\$75.05	\$76.00	See Web		
RG316/U Coax, 50 Ohm								
Part No. PE35226					Cable Dia.	Attn. @ 1 GHz	Power @ 1 GHz	90
1 piece price shown. See web or call for volume pricing.					0.098" dia.	38 dB/100ft	160 W	
12"	24"	36"	48"	60"	72"	Custom Len.		
\$62.51	\$65.39	\$68.28	\$71.17	\$79.00	\$76.95	See Web		

REVERSE THREAD SMA MALE TO REVERSE THREAD SMA MALE



Standard Flexible Cable Assemblies

Part No. PE35349					Cable Dia.	Attn. @ 1 GHz	Power @ 1 GHz	91
1 piece price shown. See web or call for volume pricing.					0.195" dia.	20 dB/100ft	44 W	
12"	24"	36"	48"	60"	72"	Custom Len.		
\$61.54	\$62.32	\$63.04	\$63.76	\$64.48	\$65.21	See Web		
RG58C/U Coax, 50 Ohm								
Part No. PE35353					Cable Dia.	Attn. @ 1 GHz	Power @ 1 GHz	92
1 piece price shown. See web or call for volume pricing.					0.195" dia.	13 dB/100ft	650 W	
12"	24"	36"	48"	60"	72"	Custom Len.		
\$64.42	\$69.94	\$75.51	\$81.04	\$86.57	\$92.15	See Web		
RG142B/U Coax, 50 Ohm								
Part No. PE35357					Cable Dia.	Attn. @ 1 GHz	Power @ 1 GHz	93
1 piece price shown. See web or call for volume pricing.					0.100" dia.	32 dB/100ft	16 W	
12"	24"	36"	48"	60"	72"	Custom Len.		
\$69.24	\$69.69	\$70.11	\$70.55	\$70.98	\$71.42	See Web		
RG174A/U Coax, 50 Ohm								
Part No. PE35361					Cable Dia.	Attn. @ 1 GHz	Power @ 1 GHz	94
1 piece price shown. See web or call for volume pricing.					0.072" dia.	44 dB/100ft	78 W	
12"	24"	36"	48"	60"	72"	Custom Len.		
\$65.80	\$66.76	\$67.71	\$68.69	\$69.64	\$77.78	See Web		
RG178B/U Coax, 50 Ohm								
Part No. PE35369					Cable Dia.	Attn. @ 1 GHz	Power @ 1 GHz	95
1 piece price shown. See web or call for volume pricing.					0.210" dia.	13 dB/100ft	53 W	
12"	24"	36"	48"	60"	72"	Custom Len.		
\$66.73	\$69.64	\$72.54	\$75.43	\$78.33	\$81.24	See Web		
RG223/U Coax, 50 Ohm								
Part No. PE35373					Cable Dia.	Attn. @ 1 GHz	Power @ 1 GHz	96
1 piece price shown. See web or call for volume pricing.					0.098" dia.	38 dB/100ft	160 W	
12"	24"	36"	48"	60"	72"	Custom Len.		
\$67.85	\$70.84	\$73.84	\$76.84	\$79.84	\$82.85	See Web		

SMA MALE RIGHT ANGLE TO SMA MALE RIGHT ANGLE



Standard Flexible Cable Assemblies

Part No. PE3M0025					Cable Dia.	Attn. @ 1 GHz	Power @ 1 GHz	97
1 piece price shown. See web or call for volume pricing.					0.195" dia.	dB/100ft	W	
12"	18"	24"	30"	36"	48"	Custom Len.		
\$286.19	\$288.91	\$291.65	\$294.37	\$297.10	\$302.56	See Web		
M17/84-RG223-0XDS2 Coax, 50 Ohm								
Part No. PE3M0053					Cable Dia.	Attn. @ 1 GHz	Power @ 1 GHz	98
1 piece price shown. See web or call for volume pricing.					0.212" dia.	dB/100ft	W	
12"	18"	24"	30"	36"	48"	Custom Len.		
\$290.49	\$295.37	\$300.25	\$305.12	\$310.01	\$319.76	See Web		
M17/128-RG400-27478 Coax, 50 Ohm								
Part No. PE3M0081					Cable Dia.	Attn. @ 1 GHz	Power @ 1 GHz	99
1 piece price shown. See web or call for volume pricing.					0.195" dia.	dB/100ft	W	
12"	18"	24"	30"	36"	48"	Custom Len.		
\$287.68	\$291.14	\$294.62	\$298.08	\$301.56	\$308.50	See Web		
M17/113-RG316-27478 Coax, 50 Ohm								
Part No. PE3M0093					Cable Dia.	Attn. @ 1 GHz	Power @ 1 GHz	1
1 piece price shown. See web or call for volume pricing.					0.098" dia.	dB/100ft	W	
6"	8"	12"	16"	18"	24"	Custom Len.		
\$204.89	\$205.22	\$205.90	\$206.55	\$206.90	\$207.90	See Web		
M17/119-RG174-0XDS2 Coax, 50 Ohm								
Part No. PE3M0108					Cable Dia.	Attn. @ 1 GHz	Power @ 1 GHz	2
1 piece price shown. See web or call for volume pricing.					0.110" dia.	dB/100ft	W	
6"	8"	12"	16"	18"	24"	Custom Len.		
\$204.28	\$204.40	\$204.67	\$204.92	\$205.06	\$205.45	See Web		
M17/28-RG058-0XDS2 Coax, 50 Ohm								
Part No. PE3M0121					Cable Dia.	Attn. @ 1 GHz	Power @ 1 GHz	3
1 piece price shown. See web or call for volume pricing.					0.195" dia.	dB/100ft	W	
12"	18"	24"	30"	36"	48"	Custom Len.		
\$201.78	\$202.37	\$202.98	\$203.56	\$204.17	\$205.37	See Web		

SMA MALE RIGHT ANGLE TO SMA FEMALE BULKHEAD
SEE MOUNTING HOLE SECTION ON PAGE 369



Standard Flexible Cable Assemblies

Part No. PE3M0094					Cable Dia.	Attn. @ 1 GHz	Power @ 1 GHz	4
1 piece price shown. See web or call for volume pricing.					0.098" dia.	dB/100ft	W	
6"	8"	12"	16"	18"	24"	Custom Len.		
\$195.65	\$195.98	\$196.65	\$197.32	\$197.66	\$198.66	See Web		
M17/119-RG174-0XDS2 Coax, 50 Ohm								

Cable Assemblies

See Our Website For Current Pricing & Real-Time Stock Availability!

Continued on Next Page

For Custom Lengths, Metric Lengths or Special Configurations, Please call (949) 261-1920

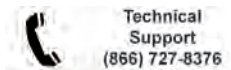

For our complete selection of cable assemblies, please visit our website

Part No.	Cable Dia.	Attn. @ 1 GHz	Power @ 1 GHz
Part No. PE3M0109	0.110" dia.	dB/100ft	W
1 piece price shown. See web or call for volume pricing.			
6"	8"	12"	16"
\$195.04	\$195.17	\$195.43	\$195.69
\$195.82	\$196.20	See Web	

SMA MALE RIGHT ANGLE TO TNC MALE

Standard Flexible Cable Assemblies

M17/60-RG142-27478 Coax, 50 Ohm

Part No.	Cable Dia.	Attn. @ 1 GHz	Power @ 1 GHz
Part No. PE3M0027	0.195" dia.	dB/100ft	W
1 piece price shown. See web or call for volume pricing.			
12"	18"	24"	30"
\$223.99	\$226.71	\$232.44	\$232.16
\$234.90	\$240.35	See Web	

M17/84-RG223-0XDS2 Coax, 50 Ohm

Part No.	Cable Dia.	Attn. @ 1 GHz	Power @ 1 GHz
Part No. PE3M0055	0.212" dia.	dB/100ft	W
1 piece price shown. See web or call for volume pricing.			
12"	18"	24"	30"
\$228.29	\$233.16	\$238.05	\$242.92
\$247.80	\$257.56	See Web	

M17/128-RG400-27478 Coax, 50 Ohm

Part No.	Cable Dia.	Attn. @ 1 GHz	Power @ 1 GHz
Part No. PE3M0083	0.195" dia.	dB/100ft	W
1 piece price shown. See web or call for volume pricing.			
12"	18"	24"	30"
\$225.47	\$228.93	\$232.41	\$235.89
\$239.35	\$246.29	See Web	

M17/113-RG316-27478 Coax, 50 Ohm

Part No.	Cable Dia.	Attn. @ 1 GHz	Power @ 1 GHz
Part No. PE3M0097	0.098" dia.	dB/100ft	W
1 piece price shown. See web or call for volume pricing.			
6"	8"	12"	16"
\$196.61	\$196.94	\$197.62	\$198.27
\$198.62	\$199.62	See Web	

M17/119-RG174-0XDS2 Coax, 50 Ohm

Part No.	Cable Dia.	Attn. @ 1 GHz	Power @ 1 GHz
Part No. PE3M0112	0.110" dia.	dB/100ft	W
1 piece price shown. See web or call for volume pricing.			
6"	8"	12"	16"
\$196.00	\$196.12	\$196.39	\$196.64
\$196.78	\$197.17	See Web	

M17/28-RG058-0XDS2 Coax, 50 Ohm

Part No.	Cable Dia.	Attn. @ 1 GHz	Power @ 1 GHz
Part No. PE3M0123	0.195" dia.	dB/100ft	W
1 piece price shown. See web or call for volume pricing.			
12"	18"	24"	30"
\$230.86	\$231.45	\$232.05	\$232.64
\$233.25	\$234.44	See Web	

SMA MALE RIGHT ANGLE TO BNC MALE

Low Loss Flexible Cable Assemblies

PE-C195 Coax, 50 Ohm

Part No.	Cable Dia.	Attn. @ 1 GHz	Power @ 1 GHz
Part No. PE38093	0.195" dia.	11 dB/100ft	150 W
1 piece price shown. See web or call for volume pricing.			
12"	24"	36"	48"
\$45.50	\$42.08	\$42.79	\$43.49
\$48.69	See Web		

Standard Flexible Cable Assemblies

RG58C/U Coax, 50 Ohm

Part No.	Cable Dia.	Attn. @ 1 GHz	Power @ 1 GHz
Part No. PE3850	0.195" dia.	20 dB/100ft	44 W
1 piece price shown. See web or call for volume pricing.			
6"	12"	18"	24"
\$52.55	\$52.55	\$52.93	\$58.62
\$59.43	\$54.77	See Web	

RG142B/U Coax, 50 Ohm

Part No.	Cable Dia.	Attn. @ 1 GHz	Power @ 1 GHz
Part No. PE3780	0.195" dia.	13 dB/100ft	650 W
1 piece price shown. See web or call for volume pricing.			
6"	12"	18"	24"
\$45.37	\$45.59	\$48.46	\$51.34
\$57.06	\$62.80	See Web	

RG174A/U Coax, 50 Ohm

Part No.	Cable Dia.	Attn. @ 1 GHz	Power @ 1 GHz
Part No. PE3C3448	0.110" dia.	32 dB/100ft	17 W
1 piece price shown. See web or call for volume pricing.			
6"	12"	18"	24"
\$51.76	\$52.04	\$52.32	\$52.61
\$53.20	\$53.04	See Web	

RG178B/U Coax, 50 Ohm

Part No.	Cable Dia.	Attn. @ 1 GHz	Power @ 1 GHz
Part No. PE33257	0.072" dia.	44 dB/100ft	78 W
1 piece price shown. See web or call for volume pricing.			
12"	24"	36"	48"
\$83.44	\$84.50	\$85.56	\$86.67
\$87.75	See Web		

RG188A/U Coax, 50 Ohm

Part No.	Cable Dia.	Attn. @ 1 GHz	Power @ 1 GHz
Part No. PE3C3437	0.110" dia.	26 dB/100ft	160 W
1 piece price shown. See web or call for volume pricing.			
6"	12"	18"	24"
\$51.79	\$55.94	\$52.91	\$54.02
\$60.93	\$63.57	See Web	

RG223/U Coax, 50 Ohm

Part No.	Cable Dia.	Attn. @ 1 GHz	Power @ 1 GHz
Part No. PE3733	0.210" dia.	13 dB/100ft	53 W
1 piece price shown. See web or call for volume pricing.			
6"	12"	18"	24"
\$59.91	\$61.42	\$57.29	\$64.53
\$67.65	\$70.94	See Web	

RG303/U Coax, 50 Ohm

Part No.	Cable Dia.	Attn. @ 1 GHz	Power @ 1 GHz
Part No. PE39138	0.170" dia.	14 dB/100ft	650 W
1 piece price shown. See web or call for volume pricing.			
12"	24"	36"	48"
\$42.93	\$51.08	\$54.40	\$60.13
\$65.86	See Web		

RG316/U Coax, 50 Ohm

Part No.	Cable Dia.	Attn. @ 1 GHz	Power @ 1 GHz
Part No. PE3C3350	0.102" dia.	38 dB/100ft	160 W
1 piece price shown. See web or call for volume pricing.			
6"	12"	18"	24"
\$54.76	\$59.14	\$56.19	\$62.26
\$65.38	\$68.69	See Web	

RG400/U Coax, 50 Ohm

Part No.	Cable Dia.	Attn. @ 1 GHz	Power @ 1 GHz
Part No. PE3642	0.195" dia.	15 dB/100ft	650 W
1 piece price shown. See web or call for volume pricing.			
6"	12"	18"	24"
\$60.18	\$62.59	\$63.66	\$67.15
\$74.12	\$81.08	See Web	

PE-P195 Coax, 50 Ohm

Part No.	Cable Dia.	Attn. @ 1 GHz	Power @ 1 GHz
Part No. PE33889	0.195" dia.	13 dB/100ft	650 W
1 piece price shown. See web or call for volume pricing.			
12"	24"	36"	48"
\$51.76	\$60.62	\$69.47	\$78.32
\$93.93	See Web		

SMA MALE RIGHT ANGLE TO BNC FEMALE BULKHEAD
SEE MOUNTING HOLE SECTION ON PAGE 369

Standard Flexible Cable Assemblies

RG316/U Coax, 50 Ohm

Part No.	Cable Dia.	Attn. @ 1 GHz	Power @ 1 GHz
Part No. PE3681	0.098" dia.	38 dB/100ft	160 W
1 piece price shown. See web or call for volume pricing.			
12"	24"	36"	48"
\$66.04	\$69.17	\$68.09	\$75.60
\$73.85	See Web		

RG400/U Coax, 50 Ohm

Part No.	Cable Dia.	Attn. @ 1 GHz	Power @ 1 GHz
Part No. PE34957	0.195" dia.	15 dB/100ft	650 W
1 piece price shown. See web or call for volume pricing.			
12"	24"	36"	48"
\$76.49	\$77.80	\$84.76	\$91.73
\$98.71	See Web		

SMA MALE RIGHT ANGLE TO MCX PLUG RIGHT ANGLE

Standard Semi-Rigid Cable Assemblies

PE-SR405AL Coax, 50 Ohm

Part No.	Cable Dia.	Attn. @ 1 GHz	Power @ 1 GHz
Part No. PE3W02882	* dia.	23 dB/100ft	130 W
1 piece price shown. See web or call for volume pricing.			
12"	24"	36"	48"
\$53.80	\$63.04	\$72.27	\$81.51
\$90.75	\$59.72	See Web	

SMA MALE RIGHT ANGLE TO MCX JACK

Standard Flexible Cable Assemblies

RG316/U Coax, 50 Ohm

Part No.	Cable Dia.	Attn. @ 1 GHz	Power @ 1 GHz
Part No. PE3W02744	0.102" dia.	38 dB/100ft	160 W
1 piece price shown. See web or call for volume pricing.			
12"	24"	36"	48"
\$65.83	\$68.86	\$71.89	\$74.92
\$77.96	\$67.76	See Web	

RG316-DS Coax, 50 Ohm

Part No.	Cable Dia.	Attn. @ 1 GHz	Power @ 1 GHz
Part No. PE3W01114	0.114" dia.	50CM	160 W
1 piece price shown. See web or call for volume pricing.			
12"	24"	36"	48"
\$58.27	\$61.30	\$64.33	\$67.37
\$70.40	\$60.21	See Web	

SMA MALE RIGHT ANGLE TO MMCX PLUG RIGHT ANGLE

Standard Flexible Cable Assemblies

RG174A/U Coax, 50 Ohm

Part No.	Cable Dia.	Attn. @ 1 GHz	Power @ 1 GHz
Part No. PE36507	0.100" dia.	32 dB/100ft	16 W
1 piece price shown. See web or call for volume pricing.			
12"	24"	36"	48"
\$66.94	\$67.51	\$68.10	\$68.71
\$62.58	See Web		

SMA MALE RIGHT ANGLE TO N MALE

Low Loss Flexible Cable Assemblies

PE-P142LL-27478 Coax, 50 Ohm



Part No.	Cable Dia.	Attn. @ 1 GHz	Power @ 1 GHz
Part No. PE3M0156	0.195" dia.	dB/100ft	W
1 piece price shown. See web or call for volume pricing.			
12"	18"	24"	36"
\$459.11	\$467.59	\$476.07	\$493.03
\$509.98	\$526.94	See Web	

Cable Assemblies

See Our Website For Current Pricing & Real-Time Stock Availability!

*Coax Performance at 1 GHz Notes: Cable assembly max frequency may be lower than connector or coax max frequency

For our complete selection of cable assemblies, please visit our website

PE-P160LL-27478 Coax, 50 Ohm						
Part No. PE3M0201		Cable Dia.	Attn. @ 1 GHz	Power @ 1 GHz		
1 piece price shown. See web or call for volume pricing.						
8"	12"	18"	24"	30"	36"	Custom Len.
\$446.55	\$451.46	\$458.81	\$466.16	\$473.51	\$480.86	See Web
PE-P300LL-27478 Coax, 50 Ohm						
Part No. PE3M0235		Cable Dia.	Attn. @ 1 GHz	Power @ 1 GHz		
1 piece price shown. See web or call for volume pricing.						
12"	18"	24"	36"	48"	60"	Custom Len.
\$530.27	\$544.43	\$558.58	\$586.88	\$615.18	\$643.48	See Web
Low Loss Test Flexible Cable Assemblies						
PE-P300LL Coax, 50 Ohm						
Part No. PE3C3238		Cable Dia.	Attn. @ 1 GHz	Power @ 1 GHz		
1 piece price shown. See web or call for volume pricing.						
12"	24"	36"	48"	60"	50CM	Custom Len.
\$249.68	\$274.87	\$300.04	\$325.23	\$350.41	\$265.83	See Web
Standard Flexible Cable Assemblies						
RG142B/U Coax, 50 Ohm						
Part No. PE3W00921		Cable Dia.	Attn. @ 1 GHz	Power @ 1 GHz		
1 piece price shown. See web or call for volume pricing.						
12"	24"	36"	48"	60"	50CM	Custom Len.
\$52.74	\$58.64	\$64.54	\$70.44	\$76.35	\$56.52	See Web
SMA MALE RIGHT ANGLE TO N MALE RIGHT ANGLE 						
Flexible Cable Assemblies						
LMR-195-FR Coax, 50 Ohm						
Part No. PE3W05298		Cable Dia.	Attn. @ 1 GHz	Power @ 1 GHz		
1 piece price shown. See web or call for volume pricing.						
12"	24"	36"	48"	60"	50CM	Custom Len.
\$54.57	\$55.57	\$56.56	\$57.56	\$58.56	\$55.20	See Web
Low Loss Flexible Cable Assemblies						
LMR-195 Coax, 50 Ohm						
Part No. PE3W00852		Cable Dia.	Attn. @ 1 GHz	Power @ 1 GHz		
1 piece price shown. See web or call for volume pricing.						
12"	24"	36"	48"	60"	50CM	Custom Len.
\$52.83	\$53.56	\$54.29	\$55.02	\$55.74	\$53.29	See Web
PE-P142LL Coax, 50 Ohm						
Part No. PE3C1528		Cable Dia.	Attn. @ 1 GHz	Power @ 1 GHz		
1 piece price shown. See web or call for volume pricing.						
12"	24"	36"	48"	60"	50CM	Custom Len.
\$304.33	\$320.56	\$336.80	\$353.04	\$369.27	\$314.73	See Web
PE-P142LL-27478 Coax, 50 Ohm						
Part No. PE3M0158		Cable Dia.	Attn. @ 1 GHz	Power @ 1 GHz		
1 piece price shown. See web or call for volume pricing.						
12"	18"	24"	36"	48"	60"	Custom Len.
\$574.14	\$582.62	\$591.10	\$608.05	\$625.01	\$641.97	See Web
PE-P160LL-27478 Coax, 50 Ohm						
Part No. PE3M0203		Cable Dia.	Attn. @ 1 GHz	Power @ 1 GHz		
1 piece price shown. See web or call for volume pricing.						
8"	12"	18"	24"	30"	36"	Custom Len.
\$544.61	\$549.52	\$556.86	\$564.22	\$571.56	\$578.92	See Web
PE-P300LL-27478 Coax, 50 Ohm						
Part No. PE3M0237		Cable Dia.	Attn. @ 1 GHz	Power @ 1 GHz		
1 piece price shown. See web or call for volume pricing.						
12"	18"	24"	36"	48"	60"	Custom Len.
\$675.21	\$689.37	\$693.13	\$731.82	\$763.24	\$788.42	See Web
Low Loss Test Flexible Cable Assemblies						
PE-P300LL Coax, 50 Ohm						
Part No. PE3C3249		Cable Dia.	Attn. @ 1 GHz	Power @ 1 GHz		
1 piece price shown. See web or call for volume pricing.						
12"	24"	36"	48"	60"	50CM	Custom Len.
\$451.55	\$476.76	\$501.96	\$527.17	\$552.36	\$467.70	See Web
SMA MALE RIGHT ANGLE TO N FEMALE BULKHEAD  SEE MOUNTING HOLE SECTION ON PAGE 369						
Precision Formable Cable Assemblies						
PE-SR402FL Coax, 50 Ohm						
Part No. PE39456		Cable Dia.	Attn. @ 1 GHz	Power @ 1 GHz		
1 piece price shown. See web or call for volume pricing.						
6"	9"	12"	18"	24"	-	Custom Len.
\$54.05	\$50.04	\$54.05	\$58.23	\$62.40	-	See Web
PE-SR402FLJ Coax, 50 Ohm						
Part No. PE39470		Cable Dia.	Attn. @ 1 GHz	Power @ 1 GHz		
1 piece price shown. See web or call for volume pricing.						
6"	9"	12"	18"	24"	-	Custom Len.
\$55.41	\$52.27	\$55.41	\$59.90	\$64.39	-	See Web
Low Loss Flexible Cable Assemblies						

PE-P142LL Coax, 50 Ohm						
Part No. PE3C2985		Cable Dia.	Attn. @ 1 GHz	Power @ 1 GHz		
1 piece price shown. See web or call for volume pricing.						
12"	24"	36"	48"	60"	50CM	Custom Len.
\$258.08	\$274.31	\$290.55	\$306.79	\$323.01	\$268.48	See Web
PE-P142LL-27478 Coax, 50 Ohm						
Part No. PE3M0157		Cable Dia.	Attn. @ 1 GHz	Power @ 1 GHz		
1 piece price shown. See web or call for volume pricing.						
12"	18"	24"	36"	48"	60"	Custom Len.
\$546.32	\$554.79	\$563.27	\$580.23	\$597.19	\$614.14	See Web
PE-P160LL-27478 Coax, 50 Ohm						
Part No. PE3M0202		Cable Dia.	Attn. @ 1 GHz	Power @ 1 GHz		
1 piece price shown. See web or call for volume pricing.						
8"	12"	18"	24"	30"	36"	Custom Len.
\$548.55	\$553.44	\$560.80	\$568.15	\$575.50	\$582.85	See Web
PE-P300LL-27478 Coax, 50 Ohm						
Part No. PE3M0236		Cable Dia.	Attn. @ 1 GHz	Power @ 1 GHz		
1 piece price shown. See web or call for volume pricing.						
12"	18"	24"	36"	48"	60"	Custom Len.
\$605.94	\$620.10	\$634.25	\$662.55	\$690.85	\$719.15	See Web
Low Loss Test Flexible Cable Assemblies						
PE-P300LL Coax, 50 Ohm						
Part No. PE3C3245		Cable Dia.	Attn. @ 1 GHz	Power @ 1 GHz		
1 piece price shown. See web or call for volume pricing.						
12"	24"	36"	48"	60"	50CM	Custom Len.
\$417.12	\$442.31	\$467.52	\$492.72	\$517.93	\$433.25	See Web
Standard Formable Cable Assemblies						
PE-SR405FL Coax, 50 Ohm						
Part No. PE39448		Cable Dia.	Attn. @ 1 GHz	Power @ 1 GHz		
1 piece price shown. See web or call for volume pricing.						
6"	9"	12"	18"	24"	-	Custom Len.
\$65.98	\$55.56	\$65.98	\$71.84	\$77.70	-	See Web
PE-SR405FLJ Coax, 50 Ohm						
Part No. PE39462		Cable Dia.	Attn. @ 1 GHz	Power @ 1 GHz		
1 piece price shown. See web or call for volume pricing.						
6"	9"	12"	18"	24"	-	Custom Len.
\$62.10	\$52.49	\$62.10	\$66.59	\$71.08	-	See Web
Standard Flexible Cable Assemblies						
RG174A/U Coax, 50 Ohm						
Part No. PE34351		Cable Dia.	Attn. @ 1 GHz	Power @ 1 GHz		
1 piece price shown. See web or call for volume pricing.						
12"	24"	36"	48"	60"	-	Custom Len.
\$84.02	\$78.24	\$85.18	\$79.10	\$79.54	-	See Web
RG316/U Coax, 50 Ohm						
Part No. PE33014		Cable Dia.	Attn. @ 1 GHz	Power @ 1 GHz		
1 piece price shown. See web or call for volume pricing.						
12"	24"	36"	48"	60"	-	Custom Len.
\$75.68	\$75.66	\$78.55	\$85.24	\$84.33	-	See Web
RG400/U Coax, 50 Ohm						
Part No. PE3179		Cable Dia.	Attn. @ 1 GHz	Power @ 1 GHz		
1 piece price shown. See web or call for volume pricing.						
12"	24"	36"	48"	60"	-	Custom Len.
\$77.59	\$80.18	\$92.38	\$94.12	\$101.08	-	See Web
SMA MALE RIGHT ANGLE TO SMA MALE 						
Low Loss Flexible Cable Assemblies						
PE-P142LL Coax, 50 Ohm						
Part No. PE342		Cable Dia.	Attn. @ 1 GHz	Power @ 1 GHz		
1 piece price shown. See web or call for volume pricing.						
12"	24"	36"	48"	60"	50CM	Custom Len.
\$196.16	\$212.40	\$228.63	\$244.87	\$261.11	\$206.57	See Web
Standard Formable Cable Assemblies						
PE-SR405FLJ Coax, 50 Ohm						
Part No. PE39431		Cable Dia.	Attn. @ 1 GHz	Power @ 1 GHz		
1 piece price shown. See web or call for volume pricing.						
6"	9"	12"	18"	24"	-	Custom Len.
\$42.12	\$40.04	\$42.12	\$46.61	\$51.10	-	See Web
Standard Flexible Cable Assemblies						
RG316/U Coax, 50 Ohm						
Part No. PE3W06425		Cable Dia.	Attn. @ 1 GHz	Power @ 1 GHz		
1 piece price shown. See web or call for volume pricing.						
12"	24"	36"	48"	60"	50CM	Custom Len.
\$54.29	\$57.56	\$60.84	\$64.13	\$67.41	\$56.39	See Web
RG316-DS Coax, 50 Ohm						
Part No. PE3W06660		Cable Dia.	Attn. @ 1 GHz	Power @ 1 GHz		
1 piece price shown. See web or call for volume pricing.						
12"	24"	36"	48"	60"	50CM	Custom Len.
\$59.38	\$62.55	\$65.87	\$69.12	\$72.38	\$61.46	See Web

Cable Assemblies

See Our Website For Current Pricing & Real-Time Stock Availability!

For Custom Lengths, Metric Lengths or Special Configurations, Please call (949) 261-1920

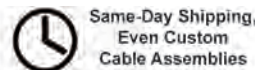
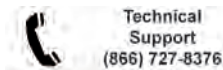

For our complete selection of cable assemblies, please visit our website

SMA MALE RIGHT ANGLE TO SMA MALE
RIGHT ANGLE



Precision Formable Cable Assemblies

PE-SR402FLJ Coax, 50 Ohm

Part No. PE39438	Cable Dia.	Attn. @ 1 GHz	Power @ 1 GHz
1 piece price shown. See web or call for volume pricing.			
6"	12"	18"	24"
\$30.28	\$28.33	\$30.28	\$34.60
		\$38.92	-
			See Web

Low Loss Flexible Cable Assemblies

PE-C195 Coax, 50 Ohm

Part No. PE35347	Cable Dia.	Attn. @ 1 GHz	Power @ 1 GHz
1 piece price shown. See web or call for volume pricing.			
12"	24"	36"	48"
\$55.15	\$51.77	\$52.49	\$53.21
			\$53.92
			See Web

PE-C240 Coax, 50 Ohm

Part No. PE38920	Cable Dia.	Attn. @ 1 GHz	Power @ 1 GHz
1 piece price shown. See web or call for volume pricing.			
12"	24"	36"	48"
\$79.10	\$77.44	\$80.26	\$82.57
			\$83.72
			See Web

PE-P142LL Coax, 50 Ohm

Part No. PE3C1425	Cable Dia.	Attn. @ 1 GHz	Power @ 1 GHz
1 piece price shown. See web or call for volume pricing.			
12"	24"	36"	48"
\$282.83	\$299.07	\$315.31	\$331.53
			\$347.77
			See Web

PE-P142LL-27478 Coax, 50 Ohm

Part No. PE3M0152	Cable Dia.	Attn. @ 1 GHz	Power @ 1 GHz
1 piece price shown. See web or call for volume pricing.			
12"	18"	24"	36"
\$548.17	\$556.64	\$565.12	\$582.08
			\$599.04
			\$615.99
			See Web

PE-P160LL-27478 Coax, 50 Ohm

Part No. PE3M0197	Cable Dia.	Attn. @ 1 GHz	Power @ 1 GHz
1 piece price shown. See web or call for volume pricing.			
8"	12"	18"	24"
\$552.49	\$557.38	\$564.74	\$572.08
			\$579.44
			\$586.79
			See Web

PE-P300LL-27478 Coax, 50 Ohm

Part No. PE3M0232	Cable Dia.	Attn. @ 1 GHz	Power @ 1 GHz
1 piece price shown. See web or call for volume pricing.			
12"	18"	24"	36"
\$642.49	\$656.64	\$670.79	\$699.09
			\$727.39
			\$755.70
			See Web

PE-P160LL Coax, 50 Ohm

Part No. PE3C5248	Cable Dia.	Attn. @ 1 GHz	Power @ 1 GHz
1 piece price shown. See web or call for volume pricing.			
12"	24"	36"	48"
\$279.67	\$300.39	\$321.09	\$341.80
			\$362.52
			\$392.94
			See Web

Low PIM Corrugated Cable Assemblies

SPP-250-LLPL Coax, 50 Ohm

Part No. PE3C5895	Cable Dia.	Attn. @ 1 GHz	Power @ 1 GHz
1 piece price shown. See web or call for volume pricing.			
12"	24"	36"	48"
\$60.26	\$65.84	\$71.42	\$77.00
			\$82.58
			\$63.84
			See Web

Low Loss Test Flexible Cable Assemblies

PE-P300LL Coax, 50 Ohm

Part No. PE3C2884	Cable Dia.	Attn. @ 1 GHz	Power @ 1 GHz
1 piece price shown. See web or call for volume pricing.			
12"	24"	36"	48"
\$316.76	\$341.95	\$367.13	\$392.31
			\$417.49
			\$332.91
			See Web

Standard Formable Cable Assemblies

PE-SR047FL Coax, 50 Ohm

Part No. PE34209	Cable Dia.	Attn. @ 1 GHz	Power @ 1 GHz
1 piece price shown. See web or call for volume pricing.			
6"	12"	18"	24"
\$154.09	\$154.09	\$157.79	\$161.47
			\$168.84
			\$176.21
			See Web

PE-SR401FL Coax, 50 Ohm

Part No. PE34217	Cable Dia.	Attn. @ 1 GHz	Power @ 1 GHz
1 piece price shown. See web or call for volume pricing.			
6"	12"	18"	24"
\$160.89	\$159.26	\$166.96	\$174.67
			\$190.06
			\$205.46
			See Web

PE-SR402FL Coax, 50 Ohm

Part No. PE3417	Cable Dia.	Attn. @ 1 GHz	Power @ 1 GHz
1 piece price shown. See web or call for volume pricing.			
6"	12"	18"	24"
\$80.12	\$84.04	\$88.08	\$92.12
			\$100.20
			\$104.21
			See Web

Part No. PE39424	Cable Dia.	Attn. @ 1 GHz	Power @ 1 GHz
1 piece price shown. See web or call for volume pricing.			
6"	9"	12"	18"
\$61.32	\$59.35	\$61.32	\$65.50
			\$69.68
			See Web

PE-SR405FL Coax, 50 Ohm

Part No. PE39416	Cable Dia.	Attn. @ 1 GHz	Power @ 1 GHz
1 piece price shown. See web or call for volume pricing.			
6"	9"	12"	18"
\$61.19	\$61.19	\$64.85	\$70.53
			\$76.20
			See Web

Part No. PE3646	Cable Dia.	Attn. @ 1 GHz	Power @ 1 GHz
1 piece price shown. See web or call for volume pricing.			
6"	12"	18"	24"
\$100.03	\$104.04	\$109.71	\$110.73
			\$121.41
			\$132.11
			See Web

PE-SR405FLJ Coax, 50 Ohm

Part No. PE39430	Cable Dia.	Attn. @ 1 GHz	Power @ 1 GHz
1 piece price shown. See web or call for volume pricing.			
6"	9"	12"	18"
\$32.19	\$30.11	\$32.19	\$36.68
			\$41.17
			See Web

Standard Flexible Cable Assemblies

RG58C/U Coax, 50 Ohm

Part No. PE3655	Cable Dia.	Attn. @ 1 GHz	Power @ 1 GHz
1 piece price shown. See web or call for volume pricing.			
6"	12"	18"	24"
\$58.35	\$58.75	\$59.15	\$56.14
			\$60.38
			\$57.57
			See Web

RG142B/U Coax, 50 Ohm

Part No. PE3514	Cable Dia.	Attn. @ 1 GHz	Power @ 1 GHz
1 piece price shown. See web or call for volume pricing.			
6"	12"	18"	24"
\$65.17	\$68.12	\$67.13	\$70.00
			\$80.27
			\$86.70
			See Web

RG174A/U Coax, 50 Ohm

Part No. PE3775	Cable Dia.	Attn. @ 1 GHz	Power @ 1 GHz
1 piece price shown. See web or call for volume pricing.			
6"	12"	18"	24"
\$64.38	\$64.66	\$64.95	\$65.24
			\$63.05
			\$66.42
			See Web

RG178B/U Coax, 50 Ohm

Part No. PE3876	Cable Dia.	Attn. @ 1 GHz	Power @ 1 GHz
1 piece price shown. See web or call for volume pricing.			
6"	12"	18"	24"
\$86.51	\$82.09	\$87.55	\$88.08
			\$84.00
			\$84.96
			See Web

RG188A/U Coax, 50 Ohm

Part No. PE3511	Cable Dia.	Attn. @ 1 GHz	Power @ 1 GHz
1 piece price shown. See web or call for volume pricing.			
6"	12"	18"	24"
\$70.34	\$66.25	\$72.79	\$74.04
			\$76.53
			\$72.91
			See Web

RG188-DS Coax, 50 Ohm

Part No. PE3347	Cable Dia.	Attn. @ 1 GHz	Power @ 1 GHz
1 piece price shown. See web or call for volume pricing.			
6"	12"	18"	24"
\$69.20	\$73.35	\$70.90	\$72.59
			\$75.99
			\$79.39
			See Web

RG223/U Coax, 50 Ohm

Part No. PE3428	Cable Dia.	Attn. @ 1 GHz	Power @ 1 GHz
1 piece price shown. See web or call for volume pricing.			
6"	12"	18"	24"
\$62.38	\$63.89	\$61.72	\$63.17
			\$66.07
			\$73.42
			See Web

RG316/U Coax, 50 Ohm

Part No. PE3515	Cable Dia.	Attn. @ 1 GHz	Power @ 1 GHz
1 piece price shown. See web or call for volume pricing.			
6"	12"	18"	24"
\$65.80	\$67.32	\$68.89	\$70.44
			\$73.57
			\$76.88
			See Web

RG316-DS Coax, 50 Ohm

Part No. PE3987	Cable Dia.	Attn. @ 1 GHz	Power @ 1 GHz
1 piece price shown. See web or call for volume pricing.			
6"	12"	18"	24"
\$68.71	\$70.23	\$71.78	\$73.34
			\$76.47
			\$74.97
			See Web

RG400/U Coax, 50 Ohm

Part No. PE3713	Cable Dia.	Attn. @ 1 GHz	Power @ 1 GHz
1 piece price shown. See web or call for volume pricing.			
6"	12"	18"	24"
\$73.71	\$73.71	\$83.30	\$80.68
			\$94.39
			\$94.63
			See Web

PE-P086EAM Coax, 50 Ohm

Part No. PE3CA1041	Cable Dia.	Attn. @ 1 GHz	Power @ 1 GHz
1 piece price shown. See web or call for volume pricing.			
12"	24"	36"	50CM
\$69.91	\$82.15	\$94.39	\$77.68
			\$97.82
			See Web

PE-P141EAM Coax, 50 Ohm

Part No. PE3CA1037	Cable Dia.	Attn. @ 1 GHz	Power @ 1 GHz
1 piece price shown. See web or call for volume pricing.			
12"	24"	36"	50CM
\$81.30	\$100.39	\$119.49	\$93.53
			\$124.83
			See Web

Standard Semi-Rigid Cable Assemblies

PE-020SR Coax, 50 Ohm

Part No. PE34211	Cable Dia.	Attn. @ 1 GHz	Power @ 1 GHz
1 piece price shown. See web or call for volume pricing.			
6"	12"	18"	24"
\$154.80	\$163.57	\$172.38	\$181.16
			\$198.74
			\$216.32
			See Web

PE-047SR Coax, 50 Ohm

Part No. PE3147	Cable Dia.	Attn. @ 1 GHz	Power @ 1 GHz
1 piece price shown. See web or call for volume pricing.			
6"	12"	18"	24"
\$143.22	\$148.20	\$153.13	\$158.10
			\$168.01
			\$177.96
			See Web

PE-SR047AL Coax, 50 Ohm

Cable Assemblies See Our Website For Current Pricing & Real-Time Stock Availability!

*Coax Performance at 1 GHz Notes: Cable assembly max frequency may be lower than connector or coax max frequency

For our complete selection of cable assemblies, please visit our website

Part No. PE3259	Cable Dia.			Attn. @ 1 GHz	Power @ 1 GHz
1 piece price shown. See web or call for volume pricing.					
6"	12"	18"	24"	36"	48"
\$142.68	\$147.06	\$151.44	\$155.83	\$164.65	\$173.46

Part No. PE34208	Cable Dia.			Attn. @ 1 GHz	Power @ 1 GHz
1 piece price shown. See web or call for volume pricing.					
6"	12"	18"	24"	36"	48"
\$85.16	\$90.27	\$95.36	\$100.44	\$103.97	\$113.39

Part No. PE34213	Cable Dia.			Attn. @ 1 GHz	Power @ 1 GHz
1 piece price shown. See web or call for volume pricing.					
6"	12"	18"	24"	36"	48"
\$89.99	\$94.19	\$98.32	\$102.53	\$110.88	\$119.27

Part No. PE34223	Cable Dia.			Attn. @ 1 GHz	Power @ 1 GHz
1 piece price shown. See web or call for volume pricing.					
6"	12"	18"	24"	36"	48"
\$165.99	\$165.99	\$176.97	\$187.94	\$209.89	\$231.83

Part No. PE3819	Cable Dia.			Attn. @ 1 GHz	Power @ 1 GHz
1 piece price shown. See web or call for volume pricing.					
6"	12"	18"	24"	36"	48"
\$84.17	\$87.96	\$86.65	\$90.30	\$103.61	\$104.90

Part No. PE3820	Cable Dia.			Attn. @ 1 GHz	Power @ 1 GHz
1 piece price shown. See web or call for volume pricing.					
6"	12"	18"	24"	36"	48"
\$89.15	\$92.45	\$95.74	\$99.10	\$105.77	\$112.37

Part No. PE34215	Cable Dia.			Attn. @ 1 GHz	Power @ 1 GHz
1 piece price shown. See web or call for volume pricing.					
6"	12"	18"	24"	36"	48"
\$162.06	\$162.06	\$171.13	\$180.21	\$198.35	\$216.49

Standard Flexible Cable Assemblies

Part No. PE3380	Cable Dia.			Attn. @ 1 GHz	Power @ 1 GHz
1 piece price shown. See web or call for volume pricing.					
6"	12"	18"	24"	36"	48"
\$80.38	\$80.80	\$81.28	\$81.71	\$82.60	\$83.50

Part No. PE3858	Cable Dia.			Attn. @ 1 GHz	Power @ 1 GHz
1 piece price shown. See web or call for volume pricing.					
6"	12"	18"	24"	36"	48"
\$73.46	\$73.46	\$74.64	\$75.83	\$78.20	\$80.55

Part No. PE3141	Cable Dia.			Attn. @ 1 GHz	Power @ 1 GHz
1 piece price shown. See web or call for volume pricing.					
6"	12"	18"	24"	36"	48"
\$64.53	\$64.69	\$66.69	\$68.69	\$72.68	\$76.68

SMA MALE RIGHT ANGLE TO SMA FEMALE



Low Loss Flexible Cable Assemblies

Part No. PE3C2305	Cable Dia.			Attn. @ 1 GHz	Power @ 1 GHz
1 piece price shown. See web or call for volume pricing.					
12"	24"	36"	48"	60"	50CM
\$225.89	\$242.13	\$258.37	\$274.61	\$290.84	\$236.30

Standard Formable Cable Assemblies

Part No. PE3W02994	Cable Dia.			Attn. @ 1 GHz	Power @ 1 GHz
1 piece price shown. See web or call for volume pricing.					
12"	24"	36"	48"	60"	50CM
\$48.53	\$57.48	\$66.43	\$75.39	\$84.35	\$54.27

SMA MALE RIGHT ANGLE TO SMA FEMALE BULKHEAD
SEE MOUNTING HOLE SECTION ON PAGE 369



Precision Formable Cable Assemblies

Part No. PE39428	Cable Dia.			Attn. @ 1 GHz	Power @ 1 GHz
1 piece price shown. See web or call for volume pricing.					
6"	9"	12"	18"	24"	Custom Len.
\$42.92	\$40.96	\$42.92	\$47.10	\$51.27	-

Part No. PE39442	Cable Dia.			Attn. @ 1 GHz	Power @ 1 GHz
1 piece price shown. See web or call for volume pricing.					
6"	9"	12"	18"	24"	Custom Len.
\$44.31	\$42.30	\$44.31	\$48.80	\$53.29	-

Low Loss Flexible Cable Assemblies

Part No. PE38574	Cable Dia.			Attn. @ 1 GHz	Power @ 1 GHz
1 piece price shown. See web or call for volume pricing.					
12"	24"	36"	48"	60"	Custom Len.
\$51.88	\$53.08	\$54.29	\$55.49	\$56.69	-

Part No. PE3C5244	Cable Dia.			Attn. @ 1 GHz	Power @ 1 GHz
1 piece price shown. See web or call for volume pricing.					
12"	24"	36"	48"	60"	50CM
\$259.56	\$280.28	\$300.99	\$321.70	\$342.41	\$272.83

Standard Formable Cable Assemblies

Part No. PE34319	Cable Dia.			Attn. @ 1 GHz	Power @ 1 GHz
1 piece price shown. See web or call for volume pricing.					
6"	12"	18"	24"	36"	48"
\$125.27	\$132.78	\$140.21	\$147.73	\$162.67	\$177.60

Part No. PE34299	Cable Dia.			Attn. @ 1 GHz	Power @ 1 GHz
1 piece price shown. See web or call for volume pricing.					
6"	12"	18"	24"	36"	48"
\$73.54	\$71.72	\$75.48	\$79.25	\$86.80	\$94.33

Part No. PE34313	Cable Dia.			Attn. @ 1 GHz	Power @ 1 GHz
1 piece price shown. See web or call for volume pricing.					
6"	12"	18"	24"	36"	48"
\$85.47	\$85.47	\$96.26	\$96.17	\$106.86	\$117.56

Part No. PE39420	Cable Dia.			Attn. @ 1 GHz	Power @ 1 GHz
1 piece price shown. See web or call for volume pricing.					
6"	9"	12"	18"	24"	Custom Len.
\$50.94	\$48.29	\$50.94	\$56.52	\$62.10	-

Standard Flexible Cable Assemblies

Part No. PE3759	Cable Dia.			Attn. @ 1 GHz	Power @ 1 GHz
1 piece price shown. See web or call for volume pricing.					
6"	12"	18"	24"	36"	48"
\$60.57	\$58.82	\$61.69	\$64.54	\$70.28	\$76.00

Part No. PE3149	Cable Dia.			Attn. @ 1 GHz	Power @ 1 GHz
1 piece price shown. See web or call for volume pricing.					
6"	12"	18"	24"	36"	48"
\$65.56	\$65.56	\$71.10	\$65.99	\$71.96	\$72.57

Part No. PE3152	Cable Dia.			Attn. @ 1 GHz	Power @ 1 GHz
1 piece price shown. See web or call for volume pricing.					
6"	12"	18"	24"	36"	48"
\$66.63	\$69.30	\$69.83	\$67.60	\$71.41	\$69.51

Part No. PE3050	Cable Dia.			Attn. @ 1 GHz	Power @ 1 GHz
1 piece price shown. See web or call for volume pricing.					
6"	12"	18"	24"	36"	48"
\$67.37	\$72.76	\$68.48	\$69.58	\$77.75	\$74.03

Part No. PE34179	Cable Dia.			Attn. @ 1 GHz	Power @ 1 GHz
1 piece price shown. See web or call for volume pricing.					
6"	12"	18"	24"	36"	48"
\$70.40	\$68.03	\$69.74	\$71.44	\$74.84	\$78.25

Part No. PE34141	Cable Dia.			Attn. @ 1 GHz	Power @ 1 GHz
1 piece price shown. See web or call for volume pricing.					
6"	12"	18"	24"	36"	48"
\$68.28	\$68.28	\$68.98	\$69.66	\$71.04	\$72.41

Part No. PE3800	Cable Dia.			Attn. @ 1 GHz	Power @ 1 GHz
1 piece price shown. See web or call for volume pricing.					
6"	12"	18"	24"	36"	48"
\$58.93	\$55.97	\$57.42	\$58.87	\$61.77	\$64.67

Part No. PE3836	Cable Dia.			Attn. @ 1 GHz	Power @ 1 GHz
1 piece price shown. See web or call for volume pricing.					
6"	12"	18"	24"	36"	48"
\$67.02	\$67.02	\$68.46	\$69.91	\$72.79	\$75.68

Part No. PE34061	Cable Dia.			Attn. @ 1 GHz	Power @ 1 GHz
1 piece price shown. See web or call for volume pricing.					
6"	12"	18"	24"	36"	48"
\$68.84	\$67.66	\$69.12	\$70.57	\$73.49	\$76.40

Part No. PE33749	Cable Dia.			Attn. @ 1 GHz	Power @ 1 GHz
1 piece price shown. See web or call for volume pricing.					
6"	12"	18"	24"	36"	48"
\$68.52	\$68.52	\$72.95	\$77.38	\$86.24	\$95.09

Cable Assemblies

See Our Website For Current Pricing & Real-Time Stock Availability!

For Custom Lengths, Metric Lengths or Special Configurations, Please call (949) 261-1920

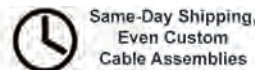
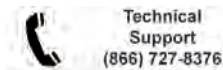

For our complete selection of cable assemblies, please visit our website

Standard Semi-Rigid Cable Assemblies

PE-SR402AL Coax, 50 Ohm						
Part No. PE34297	Cable Dia.	Attn. @ 1 GHz	Power @ 1 GHz			
1 piece price shown. See web or call for volume pricing.						
6"	12"	18"	24"	36"	48"	Custom Len.
\$63.64	\$68.20	\$72.77	\$77.32	\$86.44	\$95.57	See Web
PE-SR405AL Coax, 50 Ohm						
Part No. PE34311	Cable Dia.	Attn. @ 1 GHz	Power @ 1 GHz			
1 piece price shown. See web or call for volume pricing.						
6"	12"	18"	24"	36"	48"	Custom Len.
\$83.37	\$83.37	\$87.69	\$92.01	\$100.66	\$109.29	See Web
RG402/U Coax, 50 Ohm						
Part No. PE3679	Cable Dia.	Attn. @ 1 GHz	Power @ 1 GHz			
1 piece price shown. See web or call for volume pricing.						
6"	12"	18"	24"	36"	48"	Custom Len.
\$70.13	\$70.13	\$73.78	\$77.44	\$84.73	\$92.05	See Web
RG405/U Coax, 50 Ohm						
Part No. PE3925	Cable Dia.	Attn. @ 1 GHz	Power @ 1 GHz			
1 piece price shown. See web or call for volume pricing.						
6"	12"	18"	24"	36"	48"	Custom Len.
\$81.53	\$81.53	\$90.13	\$88.39	\$95.27	\$102.13	See Web
PE-SR401AL-STRAIGHT Coax, 50 Ohm						
Part No. PE34317	Cable Dia.	Attn. @ 1 GHz	Power @ 1 GHz			
1 piece price shown. See web or call for volume pricing.						
6"	12"	18"	24"	36"	48"	Custom Len.
\$143.54	\$143.54	\$152.62	\$161.69	\$179.83	\$197.96	See Web
Standard Flexible Cable Assemblies						
RG179B/U Coax, 75 Ohm						
Part No. PE34135	Cable Dia.	Attn. @ 1 GHz	Power @ 1 GHz			
1 piece price shown. See web or call for volume pricing.						
6"	12"	18"	24"	36"	48"	Custom Len.
\$61.43	\$62.62	\$63.83	\$64.96	\$67.37	\$69.76	See Web
SMA MALE RIGHT ANGLE TO REVERSE POLARITY SMA MALE RIGHT ANGLE						
Standard Flexible Cable Assemblies						
RG174A/U Coax, 50 Ohm						
Part No. PE3W05106	Cable Dia.	Attn. @ 1 GHz	Power @ 1 GHz			
1 piece price shown. See web or call for volume pricing.						
12"	24"	36"	48"	60"	50CM	Custom Len.
\$87.05	\$98.43	\$99.00	\$99.56	\$100.12	\$98.23	See Web
SMA MALE RIGHT ANGLE TO REVERSE POLARITY SMA FEMALE						
Standard Flexible Cable Assemblies						
RG142B/U Coax, 50 Ohm						
Part No. PE3W03763	Cable Dia.	Attn. @ 1 GHz	Power @ 1 GHz			
1 piece price shown. See web or call for volume pricing.						
12"	24"	36"	48"	60"	50CM	Custom Len.
\$66.65	\$72.54	\$78.44	\$84.35	\$90.25	\$70.42	See Web
SMA MALE RIGHT ANGLE TO SMB PLUG						
Standard Flexible Cable Assemblies						
RG174A/U Coax, 50 Ohm						
Part No. PE33482	Cable Dia.	Attn. @ 1 GHz	Power @ 1 GHz			
1 piece price shown. See web or call for volume pricing.						
12"	24"	36"	48"	60"	-	Custom Len.
\$66.48	\$67.06	\$67.63	\$68.24	\$68.83	-	See Web
SMA MALE RIGHT ANGLE TO SMB PLUG RIGHT ANGLE						
Standard Formable Cable Assemblies						
PE-SR405FL Coax, 50 Ohm						
Part No. PE3W01739	Cable Dia.	Attn. @ 1 GHz	Power @ 1 GHz			
1 piece price shown. See web or call for volume pricing.						
12"	24"	36"	48"	60"	50CM	Custom Len.
\$67.08	\$78.09	\$89.10	\$100.12	\$111.13	\$74.13	See Web
SMA MALE RIGHT ANGLE TO SMC PLUG RIGHT ANGLE						
Standard Flexible Cable Assemblies						
RG316/U Coax, 50 Ohm						



Part No. PE3740	Cable Dia.	Attn. @ 1 GHz	Power @ 1 GHz			
1 piece price shown. See web or call for volume pricing.						
12"	24"	36"	48"	60"	50CM	Custom Len.
\$57.16	\$60.19	\$63.22	\$66.26	\$72.32	\$59.10	See Web
SMA MALE RIGHT ANGLE TO SSMC PLUG						
Low Loss Flexible Cable Assemblies						
LMR-100A-PVC Coax, 50 Ohm						
Part No. PE3C4424	Cable Dia.	Attn. @ 1 GHz	Power @ 1 GHz			
1 piece price shown. See web or call for volume pricing.						
6"	12"	18"	24"	36"	48"	Custom Len.
\$59.79	\$60.18	\$60.54	\$60.92	\$61.65	\$62.39	See Web
Standard Formable Cable Assemblies						
PE-SR405FLJ Coax, 50 Ohm						
Part No. PE3C4446	Cable Dia.	Attn. @ 1 GHz	Power @ 1 GHz			
1 piece price shown. See web or call for volume pricing.						
6"	12"	18"	24"	36"	48"	Custom Len.
\$57.98	\$61.75	\$65.52	\$69.27	\$76.79	\$84.33	See Web
Standard Flexible Cable Assemblies						
RG316/U Coax, 50 Ohm						
Part No. PE3C4407	Cable Dia.	Attn. @ 1 GHz	Power @ 1 GHz			
1 piece price shown. See web or call for volume pricing.						
6"	12"	18"	24"	36"	48"	Custom Len.
\$62.96	\$64.31	\$65.66	\$66.99	\$69.70	\$72.38	See Web
SMA MALE RIGHT ANGLE TO SSMC PLUG RIGHT ANGLE						
Low Loss Flexible Cable Assemblies						
LMR-100A-PVC Coax, 50 Ohm						
Part No. PE3C4425	Cable Dia.	Attn. @ 1 GHz	Power @ 1 GHz			
1 piece price shown. See web or call for volume pricing.						
6"	12"	18"	24"	36"	48"	Custom Len.
\$56.37	\$60.16	\$57.11	\$57.48	\$58.22	\$58.95	See Web
Standard Formable Cable Assemblies						
PE-SR405FLJ Coax, 50 Ohm						
Part No. PE3C4485	Cable Dia.	Attn. @ 1 GHz	Power @ 1 GHz			
1 piece price shown. See web or call for volume pricing.						
6"	12"	18"	24"	36"	48"	Custom Len.
\$58.03	\$58.65	\$62.42	\$66.17	\$73.70	\$81.23	See Web
Standard Flexible Cable Assemblies						
RG316/U Coax, 50 Ohm						
Part No. PE3C4408	Cable Dia.	Attn. @ 1 GHz	Power @ 1 GHz			
1 piece price shown. See web or call for volume pricing.						
6"	12"	18"	24"	36"	48"	Custom Len.
\$62.18	\$69.95	\$65.00	\$66.38	\$69.20	\$71.99	See Web
RG316-DS Coax, 50 Ohm						
Part No. PE3C4472	Cable Dia.	Attn. @ 1 GHz	Power @ 1 GHz			
1 piece price shown. See web or call for volume pricing.						
6"	12"	18"	24"	36"	48"	Custom Len.
\$60.44	\$61.85	\$63.28	\$64.68	\$67.50	\$70.33	See Web
SMA MALE RIGHT ANGLE TO SSMC JACK BULKHEAD						
SEE MOUNTING HOLE SECTION ON PAGE 369						
Standard Formable Cable Assemblies						
PE-SR405FLJ Coax, 50 Ohm						
Part No. PE3C4447	Cable Dia.	Attn. @ 1 GHz	Power @ 1 GHz			
1 piece price shown. See web or call for volume pricing.						
6"	12"	18"	24"	36"	48"	Custom Len.
\$56.28	\$54.93	\$58.69	\$62.45	\$69.98	\$77.50	See Web
SMA MALE RIGHT ANGLE TO TNC MALE						
Low Loss Flexible Cable Assemblies						
LMR-100A-PVC Coax, 50 Ohm						
Part No. PE3W01985	Cable Dia.	Attn. @ 1 GHz	Power @ 1 GHz			
1 piece price shown. See web or call for volume pricing.						
12"	24"	36"	48"	60"	50CM	Custom Len.
\$57.05	\$57.79	\$58.53	\$59.25	\$59.99	\$57.53	See Web
PE-P142LL Coax, 50 Ohm						
Part No. PE3C1179	Cable Dia.	Attn. @ 1 GHz	Power @ 1 GHz			
1 piece price shown. See web or call for volume pricing.						
12"	24"	36"	48"	60"	50CM	Custom Len.
\$223.69	\$239.93	\$256.16	\$272.39	\$288.63	\$234.10	See Web





Cable Assemblies

See Our Website For Current Pricing & Real-Time Stock Availability!

*Coax Performance at 1 GHz Notes: Cable assembly max frequency may be lower than connector or coax max frequency

For our complete selection of cable assemblies, please visit our website

PE-P142LL-27478 Coax, 50 Ohm				
Part No. PE3M0153	Cable Dia.	Attn. @ 1 GHz	Power @ 1 GHz	
1 piece price shown. See web or call for volume pricing.				
12"	18"	24"	36"	40
\$467.46	\$475.93	\$484.41	\$501.37	\$518.33 \$535.28 See Web
PE-P160LL-27478 Coax, 50 Ohm				
Part No. PE3M0198	Cable Dia.	Attn. @ 1 GHz	Power @ 1 GHz	
1 piece price shown. See web or call for volume pricing.				
8"	12"	18"	24"	41
\$459.60	\$464.51	\$471.85	\$479.21	\$486.55 \$493.91 See Web
PE-P300LL-27478 Coax, 50 Ohm				
Part No. PE3M0233	Cable Dia.	Attn. @ 1 GHz	Power @ 1 GHz	
1 piece price shown. See web or call for volume pricing.				
12"	18"	24"	36"	42
\$526.30	\$540.45	\$554.60	\$582.90	\$611.20 \$639.50 See Web
PE-P160LL Coax, 50 Ohm				
Part No. PE3C5261	Cable Dia.	Attn. @ 1 GHz	Power @ 1 GHz	
1 piece price shown. See web or call for volume pricing.				
12"	24"	36"	48"	43
\$242.55	\$263.27	\$283.98	\$304.70	\$325.40 \$255.82 See Web
Standard Flexible Cable Assemblies				
RG142B/U Coax, 50 Ohm				
Part No. PE3W06829	Cable Dia.	Attn. @ 1 GHz	Power @ 1 GHz	
1 piece price shown. See web or call for volume pricing.				
12"	24"	36"	48"	44
\$62.29	\$68.18	\$74.08	\$79.98	\$85.88 \$66.06 See Web
SMA MALE RIGHT ANGLE TO TNC MALE RIGHT ANGLE 				
Low Loss Flexible Cable Assemblies				
PE-P142LL Coax, 50 Ohm				
Part No. PE3C1409	Cable Dia.	Attn. @ 1 GHz	Power @ 1 GHz	
1 piece price shown. See web or call for volume pricing.				
12"	24"	36"	48"	45
\$304.33	\$320.56	\$336.80	\$353.04	\$370.58 \$314.73 See Web
PE-P142LL-27478 Coax, 50 Ohm				
Part No. PE3M0155	Cable Dia.	Attn. @ 1 GHz	Power @ 1 GHz	
1 piece price shown. See web or call for volume pricing.				
12"	18"	24"	36"	46
\$574.14	\$582.62	\$591.10	\$608.05	\$625.01 \$641.97 See Web
PE-P160LL-27478 Coax, 50 Ohm				
Part No. PE3M0200	Cable Dia.	Attn. @ 1 GHz	Power @ 1 GHz	
1 piece price shown. See web or call for volume pricing.				
8"	12"	18"	24"	47
\$544.61	\$549.52	\$556.86	\$564.22	\$571.56 \$578.92 See Web
PE-P300LL-27478 Coax, 50 Ohm				
Part No. PE3M0234	Cable Dia.	Attn. @ 1 GHz	Power @ 1 GHz	
1 piece price shown. See web or call for volume pricing.				
12"	18"	24"	36"	48
\$670.58	\$684.73	\$698.88	\$727.19	\$755.49 \$783.79 See Web
PE-P160LL Coax, 50 Ohm				
Part No. PE3C5262	Cable Dia.	Attn. @ 1 GHz	Power @ 1 GHz	
1 piece price shown. See web or call for volume pricing.				
12"	24"	36"	48"	49
\$301.32	\$322.04	\$342.75	\$363.45	\$384.17 \$314.59 See Web
SMA MALE RIGHT ANGLE TO TNC FEMALE BULKHEAD  SEE MOUNTING HOLE SECTION ON PAGE 369				
Precision Formable Cable Assemblies				
PE-SR402FL Coax, 50 Ohm				
Part No. PE39484	Cable Dia.	Attn. @ 1 GHz	Power @ 1 GHz	
1 piece price shown. See web or call for volume pricing.				
6"	9"	12"	18"	50
\$46.71	\$43.25	\$46.71	\$50.73	\$54.75 - See Web
PE-SR402FLJ Coax, 50 Ohm				
Part No. PE39498	Cable Dia.	Attn. @ 1 GHz	Power @ 1 GHz	
1 piece price shown. See web or call for volume pricing.				
6"	9"	12"	18"	51
\$50.72	\$46.96	\$50.72	\$55.21	\$59.70 - See Web
PE-SR405FL Coax, 50 Ohm				
Part No. PE39476	Cable Dia.	Attn. @ 1 GHz	Power @ 1 GHz	
1 piece price shown. See web or call for volume pricing.				
6"	9"	12"	18"	52
\$51.70	\$53.29	\$51.70	\$57.50	\$63.30 - See Web
Low Loss Flexible Cable Assemblies				
LMR-195 Coax, 50 Ohm				
Part No. PE3C0056	Cable Dia.	Attn. @ 1 GHz	Power @ 1 GHz	
1 piece price shown. See web or call for volume pricing.				
12"	24"	36"	48"	53
\$53.31	\$54.06	\$50.86	\$51.61	\$52.36 - See Web
PE-P142LL Coax, 50 Ohm				

Part No. PE3C1173				
Cable Dia.	Attn. @ 1 GHz	Power @ 1 GHz		
1 piece price shown. See web or call for volume pricing.				
12"	24"	36"	48"	54
\$259.03	\$275.26	\$291.50	\$307.74	\$323.98 \$269.44 See Web
PE-P142LL-27478 Coax, 50 Ohm				
Part No. PE3M0154	Cable Dia.	Attn. @ 1 GHz	Power @ 1 GHz	
1 piece price shown. See web or call for volume pricing.				
12"	18"	36"	48"	55
\$546.32	\$554.79	\$563.27	\$580.23	\$597.19 \$614.14 See Web
PE-P160LL-27478 Coax, 50 Ohm				
Part No. PE3M0199	Cable Dia.	Attn. @ 1 GHz	Power @ 1 GHz	
1 piece price shown. See web or call for volume pricing.				
8"	12"	18"	24"	56
\$540.67	\$545.58	\$552.92	\$560.28	\$567.63 \$574.98 See Web
PE-P160LL Coax, 50 Ohm				
Part No. PE3C5263	Cable Dia.	Attn. @ 1 GHz	Power @ 1 GHz	
1 piece price shown. See web or call for volume pricing.				
12"	24"	36"	48"	57
\$268.84	\$289.56	\$310.27	\$330.97	\$351.69 \$282.11 See Web
Standard Formable Cable Assemblies				
PE-SR402FL Coax, 50 Ohm				
Part No. PE3W00169	Cable Dia.	Attn. @ 1 GHz	Power @ 1 GHz	
1 piece price shown. See web or call for volume pricing.				
12"	24"	36"	48"	58
\$81.35	\$89.20	\$97.04	\$104.89	\$114.92 \$86.73 See Web
PE-SR405FLJ Coax, 50 Ohm				
Part No. PE39490	Cable Dia.	Attn. @ 1 GHz	Power @ 1 GHz	
1 piece price shown. See web or call for volume pricing.				
6"	9"	12"	18"	59
\$53.52	\$44.52	\$53.52	\$57.84	\$62.16 - See Web
Standard Flexible Cable Assemblies				
RG316/U Coax, 50 Ohm				
Part No. PE33073	Cable Dia.	Attn. @ 1 GHz	Power @ 1 GHz	
1 piece price shown. See web or call for volume pricing.				
12"	24"	36"	48"	60
\$80.15	\$83.27	\$81.37	\$89.70	\$87.16 - See Web
RG400/U Coax, 50 Ohm				
Part No. PE33759	Cable Dia.	Attn. @ 1 GHz	Power @ 1 GHz	
1 piece price shown. See web or call for volume pricing.				
12"	24"	36"	48"	61
\$78.86	\$79.99	\$86.96	\$93.93	\$100.90 - See Web
REVERSE POLARITY SMA MALE RIGHT ANGLE TO N MALE 				
Standard Flexible Cable Assemblies				
RG400/U Coax, 50 Ohm				
Part No. PE35991	Cable Dia.	Attn. @ 1 GHz	Power @ 1 GHz	
1 piece price shown. See web or call for volume pricing.				
12"	24"	36"	48"	62
\$82.86	\$96.89	\$104.27	\$112.11	\$110.74 - See Web
REVERSE POLARITY SMA MALE RIGHT ANGLE TO N MALE RIGHT ANGLE 				
Low Loss Flexible Cable Assemblies				
LMR-195 Coax, 50 Ohm				
Part No. PE3W02390	Cable Dia.	Attn. @ 1 GHz	Power @ 1 GHz	
1 piece price shown. See web or call for volume pricing.				
12"	24"	36"	48"	63
\$74.03	\$74.76	\$75.48	\$76.21	\$76.94 \$74.50 See Web
REVERSE POLARITY SMA MALE RIGHT ANGLE TO SMA MALE 				
Standard Flexible Cable Assemblies				
RG400/U Coax, 50 Ohm				
Part No. PE3W06085	Cable Dia.	Attn. @ 1 GHz	Power @ 1 GHz	
1 piece price shown. See web or call for volume pricing.				
12"	24"	36"	48"	64
\$83.18	\$90.80	\$98.41	\$106.03	\$113.65 \$80.45 See Web
SMA FEMALE TO FAKRA PLUG 				
Low Loss Flexible Cable Assemblies				
PE-C100-LSZH Coax, 50 Ohm				
Part No. PE39344A	Cable Dia.	Attn. @ 1 GHz	Power @ 1 GHz	
1 piece price shown. See web or call for volume pricing.				
12"	24"	36"	48"	65
\$41.22	\$38.66	\$39.87	\$41.08	\$42.29 - See Web

Cable Assemblies

See Our Website For Current Pricing & Real-Time Stock Availability!

For Custom Lengths, Metric Lengths or Special Configurations, Please call (949) 261-1920

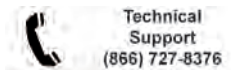

For our complete selection of cable assemblies, please visit our website

Part No.	PE39344C	Cable Dia.	Attn. @ 1 GHz	Power @ 1 GHz
1 piece price shown. See web or call for volume pricing.				
12"	24"	36"	48"	60"
\$41.22	\$38.66	\$39.87	\$41.08	\$42.29
- See Web				
Part No.	PE39344D	Cable Dia.	Attn. @ 1 GHz	Power @ 1 GHz
1 piece price shown. See web or call for volume pricing.				
12"	24"	36"	48"	60"
\$41.22	\$42.54	\$39.87	\$41.08	\$42.29
- See Web				
Part No.	PE39344H	Cable Dia.	Attn. @ 1 GHz	Power @ 1 GHz
1 piece price shown. See web or call for volume pricing.				
12"	24"	36"	48"	60"
\$42.43	\$39.79	\$41.00	\$42.19	\$43.40
- See Web				
Part No.	PE39344I	Cable Dia.	Attn. @ 1 GHz	Power @ 1 GHz
1 piece price shown. See web or call for volume pricing.				
12"	24"	36"	48"	60"
\$41.22	\$38.66	\$39.87	\$41.08	\$42.29
- See Web				
Part No.	PE39344K	Cable Dia.	Attn. @ 1 GHz	Power @ 1 GHz
1 piece price shown. See web or call for volume pricing.				
12"	24"	36"	48"	60"
\$37.47	\$42.54	\$39.87	\$41.08	\$42.29
- See Web				
Part No.	PE39344Z	Cable Dia.	Attn. @ 1 GHz	Power @ 1 GHz
1 piece price shown. See web or call for volume pricing.				
12"	24"	36"	48"	60"
\$37.47	\$41.79	\$39.87	\$41.08	\$42.29
- See Web				

Standard Flexible Cable Assemblies

RG174A/U Coax, 50 Ohm

Part No.	PE39345C	Cable Dia.	Attn. @ 1 GHz	Power @ 1 GHz
1 piece price shown. See web or call for volume pricing.				
12"	24"	36"	48"	60"
\$48.88	\$44.98	\$45.46	\$46.00	\$46.54
- See Web				
Part No.	PE39345Z	Cable Dia.	Attn. @ 1 GHz	Power @ 1 GHz
1 piece price shown. See web or call for volume pricing.				
12"	24"	36"	48"	60"
\$48.88	\$44.98	\$45.46	\$46.00	\$46.54
- See Web				

RG316/U Coax, 50 Ohm

Part No.	PE39346A	Cable Dia.	Attn. @ 1 GHz	Power @ 1 GHz
1 piece price shown. See web or call for volume pricing.				
12"	24"	36"	48"	60"
\$51.46	\$54.34	\$57.24	\$60.13	\$63.02
- See Web				

Part No.	PE39346I	Cable Dia.	Attn. @ 1 GHz	Power @ 1 GHz
1 piece price shown. See web or call for volume pricing.				
12"	24"	36"	48"	60"
\$51.46	\$54.34	\$57.24	\$60.13	\$63.02
- See Web				

Part No.	PE39346K	Cable Dia.	Attn. @ 1 GHz	Power @ 1 GHz
1 piece price shown. See web or call for volume pricing.				
12"	24"	36"	48"	60"
\$51.45	\$49.65	\$52.54	\$55.42	\$58.30
- See Web				

Part No.	PE39346Z	Cable Dia.	Attn. @ 1 GHz	Power @ 1 GHz
1 piece price shown. See web or call for volume pricing.				
12"	24"	36"	48"	60"
\$46.78	\$49.65	\$52.54	\$55.42	\$58.30
- See Web				

SMA FEMALE TO FAKRA JACK



Low Loss Flexible Cable Assemblies

PE-C100-LSZH Coax, 50 Ohm

Part No.	PE39349A	Cable Dia.	Attn. @ 1 GHz	Power @ 1 GHz
1 piece price shown. See web or call for volume pricing.				
12"	24"	36"	48"	60"
\$41.22	\$38.66	\$39.87	\$41.08	\$42.29
- See Web				

Part No.	PE39349B	Cable Dia.	Attn. @ 1 GHz	Power @ 1 GHz
1 piece price shown. See web or call for volume pricing.				
12"	24"	36"	48"	60"
\$41.22	\$38.66	\$39.87	\$41.08	\$42.29
- See Web				

Part No.	PE39349C	Cable Dia.	Attn. @ 1 GHz	Power @ 1 GHz
1 piece price shown. See web or call for volume pricing.				
12"	24"	36"	48"	60"
\$41.22	\$38.66	\$39.87	\$41.08	\$46.62
- See Web				

Part No.	PE39349D	Cable Dia.	Attn. @ 1 GHz	Power @ 1 GHz
1 piece price shown. See web or call for volume pricing.				
12"	24"	36"	48"	60"
\$38.98	\$40.31	\$39.20	\$40.40	\$44.40
- See Web				

Part No.	PE39349H	Cable Dia.	Attn. @ 1 GHz	Power @ 1 GHz
1 piece price shown. See web or call for volume pricing.				
12"	24"	36"	48"	60"
\$41.22	\$38.66	\$39.87	\$41.08	\$42.29
- See Web				

Part No.	PE39349I	Cable Dia.	Attn. @ 1 GHz	Power @ 1 GHz
1 piece price shown. See web or call for volume pricing.				
12"	24"	36"	48"	60"
\$41.22	\$38.66	\$39.87	\$41.08	\$42.29
- See Web				

Part No.	PE39349K	Cable Dia.	Attn. @ 1 GHz	Power @ 1 GHz
1 piece price shown. See web or call for volume pricing.				
12"	24"	36"	48"	60"
\$37.47	\$42.54	\$39.87	\$41.08	\$42.29
- See Web				

Part No.	PE39349Z	Cable Dia.	Attn. @ 1 GHz	Power @ 1 GHz
1 piece price shown. See web or call for volume pricing.				
12"	24"	36"	48"	60"
\$41.22	\$38.66	\$43.87	\$41.08	\$46.62
- See Web				

Standard Flexible Cable Assemblies

RG174A/U Coax, 50 Ohm

Part No.	PE39350A	Cable Dia.	Attn. @ 1 GHz	Power @ 1 GHz
1 piece price shown. See web or call for volume pricing.				
12"	24"	36"	48"	60"
\$48.88	\$49.32	\$49.75	\$50.18	\$50.63
- See Web				

Part No.	PE39350B	Cable Dia.	Attn. @ 1 GHz	Power @ 1 GHz
1 piece price shown. See web or call for volume pricing.				
12"	24"	36"	48"	60"
\$48.00	\$48.43	\$48.86	\$49.30	\$49.73
- See Web				

Part No.	PE39350C	Cable Dia.	Attn. @ 1 GHz	Power @ 1 GHz
1 piece price shown. See web or call for volume pricing.				
12"	24"	36"	48"	60"
\$48.88	\$49.32	\$49.75	\$50.18	\$50.63
- See Web				

Part No.	PE39350D	Cable Dia.	Attn. @ 1 GHz	Power @ 1 GHz
1 piece price shown. See web or call for volume pricing.				
12"	24"	36"	48"	60"
\$47.11	\$44.98	\$45.46	\$46.00	\$46.54
- See Web				

Part No.	PE39350Z	Cable Dia.	Attn. @ 1 GHz	Power @ 1 GHz
1 piece price shown. See web or call for volume pricing.				
12"	24"	36"	48"	60"
\$53.78	\$49.32	\$49.75	\$50.18	\$50.63
- See Web				

RG316/U Coax, 50 Ohm

Part No.	PE39351A	Cable Dia.	Attn. @ 1 GHz	Power @ 1 GHz
1 piece price shown. See web or call for volume pricing.				
12"	24"	36"	48"	60"
\$51.46	\$54.34	\$57.24	\$60.13	\$63.02
- See Web				

Part No.	PE39351C	Cable Dia.	Attn. @ 1 GHz	Power @ 1 GHz
1 piece price shown. See web or call for volume pricing.				
12"	24"	36"	48"	60"
\$56.60	\$54.34	\$57.24	\$60.13	\$63.02
- See Web				

SMA FEMALE TO MCX PLUG RIGHT ANGLE



Standard Formable Cable Assemblies

PE-SR405FLJ Coax, 50 Ohm

Part No.	PE3W03859	Cable Dia.	Attn. @ 1 GHz	Power @ 1 GHz
1 piece price shown. See web or call for volume pricing.				
12"	24"	36"	48"	60"
\$67.42	\$76.38	\$85.33	\$94.29	\$103.25
- See Web				

SMA FEMALE TO MMCX PLUG



Standard Flexible Cable Assemblies

RG188-DS Coax, 50 Ohm

Part No.	PE3W03032	Cable Dia.	Attn. @ 1 GHz	Power @ 1 GHz
1 piece price shown. See web or call for volume pricing.				
12"	24"	36"	48"	60"
\$59.35	\$63.05	\$66.75	\$70.44	\$74.14
- See Web				

SMA FEMALE TO N MALE



Precision Flexible Cable Assemblies

PE-P141 Coax, 50 Ohm

Part No.	PE356	Cable Dia.	Attn. @ 1 GHz	Power @ 1 GHz
1 piece price shown. See web or call for volume pricing.				
12"	24"	36"	48"	60"
\$174.22	\$175.07	\$196.93	\$208.94	\$207.18
- See Web				

Low Loss Flexible Cable Assemblies

PE-P142LL-27478 Coax, 50 Ohm

Part No.	PE3M0141	Cable Dia.	Attn. @ 1 GHz	Power @ 1 GHz
1 piece price shown. See web or call for volume pricing.				
12"	18"	24"	36"	48"
\$425.72	\$434.20	\$442.68	\$459.63	\$476.59
- See Web				

SMA FEMALE TO N MALE RIGHT ANGLE



Low Loss Flexible Cable Assemblies

PE-P142LL-27478 Coax, 50 Ohm

Part No.	PE3M0143	Cable Dia.	Attn. @ 1 GHz	Power @ 1 GHz
1 piece price shown. See web or call for volume pricing.				
12"	18"	24"	36"	48"
\$540.75	\$549.23	\$557.70	\$574.66	\$591.62
- See Web				

*Coax Performance at 1 GHz Notes: Cable assembly max frequency may be lower than connector or coax max frequency

Cable Assemblies See Our Website For Current Pricing & Real-Time Stock Availability!

For our complete selection of cable assemblies, please visit our website

SMA FEMALE TO N FEMALE BULKHEAD
SEE MOUNTING HOLE SECTION ON PAGE 369



Low Loss Flexible Cable Assemblies

PE-P142LL Coax, 50 Ohm						
Part No. PE3C3159	Cable Dia.			Attn. @ 1 GHz	Power @ 1 GHz	
1 piece price shown. See web or call for volume pricing.						
12"	24"	36"	48"	0.195" dia.	10 dB/100ft	W
\$196.36	\$212.12	\$227.89	\$243.65	\$259.41	\$206.46	See Web

98

PE-P142LL-27478 Coax, 50 Ohm						
Part No. PE3M0142	Cable Dia.			Attn. @ 1 GHz	Power @ 1 GHz	
1 piece price shown. See web or call for volume pricing.						
12"	18"	24"	36"	48"	60"	Custom Len.
\$512.91	\$521.39	\$529.87	\$546.83	\$563.78	\$580.74	See Web

99

SMA FEMALE TO QMA MALE



Standard Flexible Cable Assemblies

RG58C/U Coax, 50 Ohm						
Part No. PE38277	Cable Dia.			Attn. @ 1 GHz	Power @ 1 GHz	
1 piece price shown. See web or call for volume pricing.						
12"	24"	36"	48"	0.195" dia.	20 dB/100ft	44 W
\$55.06	\$60.27	\$56.56	\$57.28	\$58.00	\$58.71	See Web

1

RG316/U Coax, 50 Ohm						
Part No. PE38276	Cable Dia.			Attn. @ 1 GHz	Power @ 1 GHz	
1 piece price shown. See web or call for volume pricing.						
12"	24"	36"	48"	0.098" dia.	38 dB/100ft	160 W
\$68.61	\$71.73	\$69.29	\$72.19	\$75.08	\$77.96	See Web

2

SMA FEMALE TO SMA MALE RIGHT ANGLE



Low Loss Flexible Cable Assemblies

PE-P142LL-27478 Coax, 50 Ohm						
Part No. PE3M0137	Cable Dia.			Attn. @ 1 GHz	Power @ 1 GHz	
1 piece price shown. See web or call for volume pricing.						
12"	18"	24"	36"	48"	60"	Custom Len.
\$514.77	\$523.25	\$531.73	\$548.69	\$565.64	\$582.60	See Web

3

Standard Flexible Cable Assemblies

RG174A/U Coax, 50 Ohm						
Part No. PE3W03981	Cable Dia.			Attn. @ 1 GHz	Power @ 1 GHz	
1 piece price shown. See web or call for volume pricing.						
12"	24"	36"	48"	0.110" dia.	32 dB/100ft	17 W
\$48.67	\$49.23	\$49.79	\$50.35	\$50.91	\$49.02	See Web

4

SMA FEMALE TO SMA FEMALE



Low Loss Flexible Cable Assemblies

LMR-100A-PVC Coax, 50 Ohm						
Part No. PE3C0045	Cable Dia.			Attn. @ 1 GHz	Power @ 1 GHz	
1 piece price shown. See web or call for volume pricing.						
12"	24"	36"	48"	0.110" dia.	24 dB/100ft	W
\$53.39	\$54.15	\$54.90	\$55.66	\$60.76	-	See Web

5

PE-P142LL Coax, 50 Ohm						
Part No. PE3C1239	Cable Dia.			Attn. @ 1 GHz	Power @ 1 GHz	
1 piece price shown. See web or call for volume pricing.						
12"	24"	36"	48"	0.195" dia.	10 dB/100ft	W
\$182.99	\$199.23	\$215.47	\$231.70	\$247.94	\$193.40	See Web

6

PE-P142LL-27478 Coax, 50 Ohm						
Part No. PE3M0135	Cable Dia.			Attn. @ 1 GHz	Power @ 1 GHz	
1 piece price shown. See web or call for volume pricing.						
12"	18"	24"	36"	48"	60"	Custom Len.
\$481.38	\$489.86	\$498.34	\$515.29	\$532.25	\$549.21	See Web

7

Standard Formable Cable Assemblies

PE-SR047FL Coax, 50 Ohm						
Part No. PE34833	Cable Dia.			Attn. @ 1 GHz	Power @ 1 GHz	
1 piece price shown. See web or call for volume pricing.						
6"	12"	18"	24"	0.047" dia.	36 dB/100ft	32 W
\$111.03	\$106.46	\$110.14	\$123.09	\$121.20	\$128.57	See Web

8

PE-SR402FL Coax, 50 Ohm						
Part No. PE33964	Cable Dia.			Attn. @ 1 GHz	Power @ 1 GHz	
1 piece price shown. See web or call for volume pricing.						
6"	12"	18"	24"	* dia.	12 dB/100ft	450 W
\$62.05	\$62.05	\$65.82	\$69.58	\$77.12	\$84.67	See Web

9

PE-SR405FL Coax, 50 Ohm						
Part No. PE34292	Cable Dia.			Attn. @ 1 GHz	Power @ 1 GHz	
1 piece price shown. See web or call for volume pricing.						
6"	12"	18"	24"	* dia.	23 dB/100ft	130 W
\$87.63	\$87.63	\$93.43	\$99.22	\$110.82	\$122.41	See Web

10

Standard Flexible Cable Assemblies

RG58C/U Coax, 50 Ohm						
Part No. PE33547	Cable Dia.			Attn. @ 1 GHz	Power @ 1 GHz	
1 piece price shown. See web or call for volume pricing.						
12"	24"	36"	48"	0.195" dia.	20 dB/100ft	44 W
\$63.12	\$59.18	\$59.92	\$65.60	\$61.39	-	See Web

11

RG142B/U Coax, 50 Ohm						
Part No. PE3578	Cable Dia.			Attn. @ 1 GHz	Power @ 1 GHz	
1 piece price shown. See web or call for volume pricing.						
12"	24"	36"	48"	0.195" dia.	13 dB/100ft	650 W
\$47.49	\$53.22	\$58.95	\$69.88	\$70.41	-	See Web

12

RG174A/U Coax, 50 Ohm						
Part No. PE33120	Cable Dia.			Attn. @ 1 GHz	Power @ 1 GHz	
1 piece price shown. See web or call for volume pricing.						
12"	24"	36"	48"	0.110" dia.	32 dB/100ft	17 W
\$57.86	\$63.07	\$58.72	\$64.26	\$59.61	-	See Web

13

RG223/U Coax, 50 Ohm						
Part No. PE33254	Cable Dia.			Attn. @ 1 GHz	Power @ 1 GHz	
1 piece price shown. See web or call for volume pricing.						
12"	24"	36"	48"	0.210" dia.	13 dB/100ft	53 W
\$42.45	\$45.09	\$47.74	\$54.53	\$53.06	-	See Web

14

RG316/U Coax, 50 Ohm						
Part No. PE33047	Cable Dia.			Attn. @ 1 GHz	Power @ 1 GHz	
1 piece price shown. See web or call for volume pricing.						
12"	24"	36"	48"	0.102" dia.	38 dB/100ft	W
\$63.96	\$67.09	\$66.11	\$73.52	\$76.71	-	See Web

15

Standard Semi-Rigid Cable Assemblies

PE-020SR Coax, 50 Ohm						
Part No. PE34917	Cable Dia.			Attn. @ 1 GHz	Power @ 1 GHz	
1 piece price shown. See web or call for volume pricing.						
6"	12"	18"	24"	* dia.	85 dB/100ft	3 W
\$171.22	\$181.49	\$180.28	\$189.35	\$207.49	\$225.64	See Web

16

PE-034SR Coax, 50 Ohm						
Part No. PE34405	Cable Dia.			Attn. @ 1 GHz	Power @ 1 GHz	
1 piece price shown. See web or call for volume pricing.						
6"	12"	18"	24"	* dia.	60 dB/100ft	10 W
\$151.25	\$157.22	\$154.46	\$160.61	\$172.89	\$185.18	See Web

17

PE-047SR Coax, 50 Ohm						
Part No. PE3758	Cable Dia.			Attn. @ 1 GHz	Power @ 1 GHz	
1 piece price shown. See web or call for volume pricing.						
6"	12"	18"	24"	* dia.	40 dB/100ft	32 W
\$106.34	\$111.71	\$112.53	\$122.78	\$133.84	\$138.12	See Web

18

PE-SR047AL Coax, 50 Ohm						
Part No. PE34835	Cable Dia.			Attn. @ 1 GHz	Power @ 1 GHz	
1 piece price shown. See web or call for volume pricing.						
6"	12"	18"	24"	0.047" dia.	41 dB/100ft	32 W
\$111.90	\$106.22	\$110.75	\$115.29	\$124.37	\$133.44	See Web

19

PE-SR402AL Coax, 50 Ohm						
Part No. PE34836	Cable Dia.			Attn. @ 1 GHz	Power @ 1 GHz	
1 piece price shown. See web or call for volume pricing.						
6"	12"	18"	24"	0.141" dia.	13 dB/100ft	450 W
\$63.97	\$67.81	\$68.68	\$73.37	\$82.80	\$92.20	See Web

20

PE-SR405AL Coax, 50 Ohm						
Part No. PE34834	Cable Dia.			Attn. @ 1 GHz	Power @ 1 GHz	
1 piece price shown. See web or call for volume pricing.						
6"	12"	18"	24"	* dia.	23 dB/100ft	130 W
\$73.01	\$81.84	\$81.41	\$85.54	\$93.95	\$102.29	See Web

21

RG401/U Coax, 50 Ohm						
Part No. PE3521	Cable Dia.			Attn. @ 1 GHz	Power @ 1 GHz	
1 piece price shown. See web or call for volume pricing.						
6"	12"	18"	24"	* dia.	8 dB/100ft	870 W
\$109.20	\$109.20	\$120.18	\$131.14	\$153.09	\$175.05	See Web

22

RG402/U Coax, 50 Ohm						
Part No. PE3931	Cable Dia.			Attn. @ 1 GHz	Power @ 1 GHz	
1 piece price shown. See web or call for volume pricing.						
6"	12"	18"	24"	* dia.	12 dB/100ft	650 W
\$61.71	\$65.51	\$69.42	\$69.10	\$76.41	\$83.71	See Web

23

RG405/U Coax, 50 Ohm						
Part No. PE3109	Cable Dia.			Attn. @ 1 GHz	Power @ 1 GHz	
1 piece price shown. See web or call for volume pricing.						
6"	12"	18"	24"	* dia.	22 dB/100ft	130 W
\$62.71	\$62.71	\$66.15	\$69.58	\$76.45	\$83.33	See Web

24

Standard Flexible Cable Assemblies

RG62A/U Coax, 93 Ohm						
Part No. PE3424	Cable Dia.			Attn. @ 1 GHz	Power @ 1 GHz	
1 piece price shown. See web or call for volume pricing.						
12"	24"	36"	48"	0.242" dia.	13 dB/100ft	77 W
\$63.64	\$64.90	\$66.15	\$67.42	\$68.69	-	See Web

25

SMA FEMALE TO SMA FEMALE BULKHEAD

SEE MOUNTING HOLE SECTION ON PAGE 369



Low Loss Flexible Cable Assemblies

Cable Assemblies

See Our Website For Current Pricing & Real-Time Stock Availability!



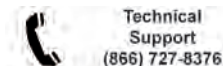

Continued on Next Page







For Custom Lengths, Metric Lengths or Special Configurations, Please call (949) 261-1920



For our complete selection of cable assemblies, please visit our website

Cable Assemblies
See Our Website For Current Pricing & Real-Time Stock Availability!

PE-P142LL-27478 Coax, 50 Ohm						
Part No. PE3M0136		Cable Dia.	Attn. @ 1 GHz	Power @ 1 GHz		
1 piece price shown. See web or call for volume pricing.		0.195" dia.	dB/100ft	W		
12"	18"	24"	36"	48"	60"	Custom Len.
\$514.03	\$522.51	\$530.99	\$547.95	\$564.90	\$581.86	See Web
SMA FEMALE TO SSMC PLUG 						
Flexible Cable Assemblies						
LMR-100A-PVC Coax, 50 Ohm						
Part No. PE3W06055		Cable Dia.	Attn. @ 1 GHz	Power @ 1 GHz		
1 piece price shown. See web or call for volume pricing.		0.110" dia.	24 dB/100ft	W		
12"	24"	36"	48"	60"	50CM	Custom Len.
\$44.50	\$45.22	\$45.94	\$46.67	\$47.40	\$44.96	See Web
Low Loss Flexible Cable Assemblies						
LMR-100A-PVC Coax, 50 Ohm						
Part No. PE3C4426		Cable Dia.	Attn. @ 1 GHz	Power @ 1 GHz		
1 piece price shown. See web or call for volume pricing.		0.110" dia.	24 dB/100ft	W		
6"	12"	18"	24"	36"	48"	Custom Len.
\$54.27	\$54.64	\$60.48	\$55.38	\$56.12	\$56.85	See Web
Standard Flexible Cable Assemblies						
RG178B/U Coax, 50 Ohm						
Part No. PE3C4393		Cable Dia.	Attn. @ 1 GHz	Power @ 1 GHz		
1 piece price shown. See web or call for volume pricing.		0.072" dia.	44 dB/100ft	55 W		
6"	12"	18"	24"	36"	48"	Custom Len.
\$73.00	\$80.82	\$73.94	\$74.40	\$75.34	\$76.26	See Web
RG316/U Coax, 50 Ohm						
Part No. PE3C4409		Cable Dia.	Attn. @ 1 GHz	Power @ 1 GHz		
1 piece price shown. See web or call for volume pricing.		0.098" dia.	58 dB/100ft	160 W		
6"	12"	18"	24"	36"	48"	Custom Len.
\$64.85	\$66.27	\$67.67	\$69.05	\$71.87	\$74.66	See Web
SMA FEMALE TO SSMC PLUG RIGHT ANGLE 						
Low Loss Flexible Cable Assemblies						
LMR-100A-PVC Coax, 50 Ohm						
Part No. PE3C4427		Cable Dia.	Attn. @ 1 GHz	Power @ 1 GHz		
1 piece price shown. See web or call for volume pricing.		0.110" dia.	24 dB/100ft	W		
6"	12"	18"	24"	36"	48"	Custom Len.
\$50.84	\$51.21	\$54.66	\$51.95	\$52.69	\$53.43	See Web
Standard Flexible Cable Assemblies						
RG178B/U Coax, 50 Ohm						
Part No. PE3C4464		Cable Dia.	Attn. @ 1 GHz	Power @ 1 GHz		
1 piece price shown. See web or call for volume pricing.		0.072" dia.	44 dB/100ft	55 W		
6"	12"	18"	24"	36"	48"	Custom Len.
\$64.58	\$65.06	\$65.53	\$65.99	\$66.92	\$67.86	See Web
RG316/U Coax, 50 Ohm						
Part No. PE3C4410		Cable Dia.	Attn. @ 1 GHz	Power @ 1 GHz		
1 piece price shown. See web or call for volume pricing.		0.098" dia.	58 dB/100ft	160 W		
6"	12"	18"	24"	36"	48"	Custom Len.
\$61.43	\$62.83	\$64.24	\$65.62	\$68.44	\$71.23	See Web
RG316-DS Coax, 50 Ohm						
Part No. PE3C4473		Cable Dia.	Attn. @ 1 GHz	Power @ 1 GHz		
1 piece price shown. See web or call for volume pricing.		0.114" dia.	9 dB/100ft	85 W		
6"	12"	18"	24"	36"	48"	Custom Len.
\$60.43	\$61.84	\$63.26	\$64.67	\$67.49	\$70.32	See Web
SMA FEMALE TO TNC MALE 						
Low Loss Flexible Cable Assemblies						
LMR-100A-PVC Coax, 50 Ohm						
Part No. PE3W00825		Cable Dia.	Attn. @ 1 GHz	Power @ 1 GHz		
1 piece price shown. See web or call for volume pricing.		0.110" dia.	24 dB/100ft	W		
12"	24"	36"	48"	60"	50CM	Custom Len.
\$52.83	\$53.57	\$54.31	\$55.05	\$55.78	\$53.31	See Web
PE-P142LL Coax, 50 Ohm						
Part No. PE3C3205		Cable Dia.	Attn. @ 1 GHz	Power @ 1 GHz		
1 piece price shown. See web or call for volume pricing.		0.195" dia.	10 dB/100ft	W		
12"	24"	36"	48"	60"	50CM	Custom Len.
\$172.82	\$189.06	\$205.29	\$221.53	\$237.76	\$183.22	See Web
PE-P142LL-27478 Coax, 50 Ohm						
Part No. PE3M0138		Cable Dia.	Attn. @ 1 GHz	Power @ 1 GHz		
1 piece price shown. See web or call for volume pricing.		0.195" dia.	dB/100ft	W		
12"	18"	24"	36"	48"	60"	Custom Len.
\$434.06	\$442.54	\$451.02	\$467.98	\$484.93	\$501.89	See Web
SMA FEMALE TO TNC MALE RIGHT ANGLE 						

Low Loss Flexible Cable Assemblies						
PE-P142LL-27478 Coax, 50 Ohm						
Part No. PE3M0140		Cable Dia.	Attn. @ 1 GHz	Power @ 1 GHz		
1 piece price shown. See web or call for volume pricing.		0.195" dia.	dB/100ft	W		
12"	18"	24"	36"	48"	60"	Custom Len.
\$540.75	\$549.23	\$557.70	\$574.66	\$591.62	\$608.57	See Web
SMA FEMALE TO TNC FEMALE BULKHEAD  SEE MOUNTING HOLE SECTION ON PAGE 369						
Low Loss Flexible Cable Assemblies						
PE-P142LL-27478 Coax, 50 Ohm						
Part No. PE3M0139		Cable Dia.	Attn. @ 1 GHz	Power @ 1 GHz		
1 piece price shown. See web or call for volume pricing.		0.195" dia.	dB/100ft	W		
12"	18"	24"	36"	48"	60"	Custom Len.
\$512.91	\$521.39	\$529.87	\$546.83	\$563.78	\$580.74	See Web
SMA FEMALE BULKHEAD TO SMA FEMALE BULKHEAD  SEE MOUNTING HOLE SECTION ON PAGE 369						
Standard Flexible Cable Assemblies						
M17/113-RG316-27478 Coax, 50 Ohm						
Part No. PE3M0095		Cable Dia.	Attn. @ 1 GHz	Power @ 1 GHz		
1 piece price shown. See web or call for volume pricing.		0.098" dia.	dB/100ft	W		
6"	8"	12"	16"	18"	24"	Custom Len.
\$186.41	\$186.73	\$187.40	\$188.07	\$188.41	\$189.41	See Web
M17/119-RG174-0XDS2 Coax, 50 Ohm						
Part No. PE3M0110		Cable Dia.	Attn. @ 1 GHz	Power @ 1 GHz		
1 piece price shown. See web or call for volume pricing.		0.110" dia.	dB/100ft	W		
6"	8"	12"	16"	18"	24"	Custom Len.
\$185.79	\$185.92	\$186.18	\$186.44	\$186.56	\$186.96	See Web
SMA FEMALE BULKHEAD TO TNC MALE  SEE MOUNTING HOLE SECTION ON PAGE 369						
Standard Flexible Cable Assemblies						
M17/113-RG316-27478 Coax, 50 Ohm						
Part No. PE3M0098		Cable Dia.	Attn. @ 1 GHz	Power @ 1 GHz		
1 piece price shown. See web or call for volume pricing.		0.098" dia.	dB/100ft	W		
6"	8"	12"	16"	18"	24"	Custom Len.
\$187.37	\$187.70	\$188.37	\$189.04	\$189.38	\$190.38	See Web
M17/119-RG174-0XDS2 Coax, 50 Ohm						
Part No. PE3M0113		Cable Dia.	Attn. @ 1 GHz	Power @ 1 GHz		
1 piece price shown. See web or call for volume pricing.		0.110" dia.	dB/100ft	W		
6"	8"	12"	16"	18"	24"	Custom Len.
\$186.76	\$186.87	\$187.14	\$187.39	\$187.54	\$187.92	See Web
SMA FEMALE BULKHEAD TO MCX PLUG RIGHT ANGLE  SEE MOUNTING HOLE SECTION ON PAGE 369						
Precision Formable Cable Assemblies						
PE-SR405FL Coax, 50 Ohm						
Part No. PE39421		Cable Dia.	Attn. @ 1 GHz	Power @ 1 GHz		
1 piece price shown. See web or call for volume pricing.		" dia.	dB/100ft	130 W		
6"	9"	12"	18"	24"	-	Custom Len.
\$43.35	\$39.40	\$43.35	\$49.14	\$54.94	-	See Web
Standard Formable Cable Assemblies						
PE-SR405FLJ Coax, 50 Ohm						
Part No. PE39435		Cable Dia.	Attn. @ 1 GHz	Power @ 1 GHz		
1 piece price shown. See web or call for volume pricing.		0.105" dia.	20 dB/100ft	122 W		
6"	9"	12"	18"	24"	-	Custom Len.
\$38.12	\$36.04	\$38.12	\$42.61	\$47.10	-	See Web
SMA FEMALE BULKHEAD TO MMCX PLUG  SEE MOUNTING HOLE SECTION ON PAGE 369						
Standard Flexible Cable Assemblies						
RG316/U Coax, 50 Ohm						
Part No. PE35575		Cable Dia.	Attn. @ 1 GHz	Power @ 1 GHz		
1 piece price shown. See web or call for volume pricing.		0.098" dia.	38 dB/100ft	160 W		
12"	24"	36"	48"	60"	-	Custom Len.
\$58.15	\$61.28	\$64.40	\$63.53	\$66.41	-	See Web
SMA FEMALE BULKHEAD TO MMCX PLUG RIGHT ANGLE  SEE MOUNTING HOLE SECTION ON PAGE 369						
Precision Formable Cable Assemblies						
PE-SR405FL Coax, 50 Ohm						

*Coax Performance at 1 GHz Notes: Cable assembly max frequency may be lower than connector or coax max frequency

For our complete selection of cable assemblies, please visit our website

Part No.	PE39422	Cable Dia.	Attn. @ 1 GHz	Power @ 1 GHz
1 piece price shown. See web or call for volume pricing.				
6"	9"	12"	18"	24"
\$43.13	\$40.37	\$43.13	\$48.93	\$54.72

Standard Formable Cable Assemblies

PE-SR405FLJ Coax, 50 Ohm

Part No.	PE39436	Cable Dia.	Attn. @ 1 GHz	Power @ 1 GHz
1 piece price shown. See web or call for volume pricing.				
6"	9"	12"	18"	24"
\$58.53	\$56.45	\$58.53	\$63.02	\$67.50

Standard Flexible Cable Assemblies

RG174A/U Coax, 50 Ohm

Part No.	PE34786	Cable Dia.	Attn. @ 1 GHz	Power @ 1 GHz
1 piece price shown. See web or call for volume pricing.				
12"	24"	36"	48"	60"
\$58.17	\$58.72	\$59.27	\$59.84	\$60.39

RG178B/U Coax, 50 Ohm

Part No.	PE3C3821	Cable Dia.	Attn. @ 1 GHz	Power @ 1 GHz
1 piece price shown. See web or call for volume pricing.				
12"	24"	36"	48"	60"
\$60.66	\$61.69	\$62.71	\$63.74	\$64.77

RG188-DS Coax, 50 Ohm

Part No.	PE3W00934	Cable Dia.	Attn. @ 1 GHz	Power @ 1 GHz
1 piece price shown. See web or call for volume pricing.				
12"	24"	36"	48"	60"
\$69.07	\$72.49	\$75.91	\$79.33	\$82.75

RG316/U Coax, 50 Ohm

Part No.	PE3C1081	Cable Dia.	Attn. @ 1 GHz	Power @ 1 GHz
1 piece price shown. See web or call for volume pricing.				
12"	24"	36"	48"	60"
\$55.41	\$58.44	\$61.48	\$64.51	\$67.55

Part No.	PE34686	Cable Dia.	Attn. @ 1 GHz	Power @ 1 GHz
1 piece price shown. See web or call for volume pricing.				
12"	24"	36"	48"	60"
\$59.05	\$62.16	\$65.29	\$68.43	\$71.78

SMA FEMALE BULKHEAD TO N MALE

SEE MOUNTING HOLE SECTION ON PAGE 369

Low Loss Flexible Cable Assemblies

PE-P142LL-27478 Coax, 50 Ohm

Part No.	PE3M0149	Cable Dia.	Attn. @ 1 GHz	Power @ 1 GHz
1 piece price shown. See web or call for volume pricing.				
12"	18"	24"	36"	48"
\$458.37	\$466.84	\$475.32	\$492.28	\$509.23

PE-P160LL-27478 Coax, 50 Ohm

Part No.	PE3M0194	Cable Dia.	Attn. @ 1 GHz	Power @ 1 GHz
1 piece price shown. See web or call for volume pricing.				
8"	12"	18"	24"	30"
\$442.62	\$447.52	\$454.87	\$462.22	\$469.58

SMA FEMALE BULKHEAD TO N MALE RIGHT ANGLE

SEE MOUNTING HOLE SECTION ON PAGE 369

Low Loss Flexible Cable Assemblies

PE-P142LL-27478 Coax, 50 Ohm

Part No.	PE3M0151	Cable Dia.	Attn. @ 1 GHz	Power @ 1 GHz
1 piece price shown. See web or call for volume pricing.				
12"	18"	24"	36"	48"
\$573.40	\$581.88	\$590.36	\$607.32	\$624.27

PE-P160LL-27478 Coax, 50 Ohm

Part No.	PE3M0196	Cable Dia.	Attn. @ 1 GHz	Power @ 1 GHz
1 piece price shown. See web or call for volume pricing.				
8"	12"	18"	24"	30"
\$540.67	\$545.58	\$552.92	\$560.28	\$567.63

SMA FEMALE BULKHEAD TO N FEMALE BULKHEAD

SEE MOUNTING HOLE SECTION ON PAGE 369

Low Loss Flexible Cable Assemblies

PE-P142LL-27478 Coax, 50 Ohm

Part No.	PE3M0150	Cable Dia.	Attn. @ 1 GHz	Power @ 1 GHz
1 piece price shown. See web or call for volume pricing.				
12"	18"	24"	36"	48"
\$545.57	\$554.05	\$562.52	\$579.48	\$596.44

PE-P160LL-27478 Coax, 50 Ohm

Part No.	PE3M0195	Cable Dia.	Attn. @ 1 GHz	Power @ 1 GHz
1 piece price shown. See web or call for volume pricing.				
8"	12"	18"	24"	30"
\$544.61	\$549.52	\$556.86	\$564.22	\$571.56

SMA FEMALE BULKHEAD TO SMA MALE

SEE MOUNTING HOLE SECTION ON PAGE 369



Standard Formable Cable Assemblies

PE-SR402FL Coax, 50 Ohm

Part No.	PE39427	Cable Dia.	Attn. @ 1 GHz	Power @ 1 GHz
1 piece price shown. See web or call for volume pricing.				
6"	9"	12"	18"	24"
\$52.44	\$50.47	\$52.44	\$56.62	\$60.79

Part No.	PE3468	Cable Dia.	Attn. @ 1 GHz	Power @ 1 GHz
1 piece price shown. See web or call for volume pricing.				
6"	12"	18"	24"	36"
\$59.25	\$63.17	\$67.21	\$67.13	\$74.67

PE-SR402FLJ Coax, 50 Ohm

Part No.	PE3W04417	Cable Dia.	Attn. @ 1 GHz	Power @ 1 GHz
1 piece price shown. See web or call for volume pricing.				
12"	24"	36"	48"	60"
\$49.05	\$57.93	\$66.82	\$75.70	\$84.58

Standard Flexible Cable Assemblies

RG316-DS Coax, 50 Ohm

Part No.	PE3973	Cable Dia.	Attn. @ 1 GHz	Power @ 1 GHz
1 piece price shown. See web or call for volume pricing.				
6"	12"	18"	24"	36"
\$53.35	\$54.87	\$56.43	\$58.00	\$57.58

PE-P141EAM Coax, 50 Ohm

Part No.	PE3CA1038	Cable Dia.	Attn. @ 1 GHz	Power @ 1 GHz
1 piece price shown. See web or call for volume pricing.				
12"	24"	36"	50CM	100CM
\$79.67	\$101.60	\$123.54	\$83.67	\$115.80

SMA FEMALE BULKHEAD TO SMA MALE RIGHT ANGLE

SEE MOUNTING HOLE SECTION ON PAGE 369



Flexible Cable Assemblies

LMR-195 Coax, 50 Ohm

Part No.	PE3W05962	Cable Dia.	Attn. @ 1 GHz	Power @ 1 GHz
1 piece price shown. See web or call for volume pricing.				
12"	24"	36"	48"	60"
\$33.03	\$33.67	\$34.32	\$34.96	\$35.61

Low Loss Flexible Cable Assemblies

PE-P142LL-27478 Coax, 50 Ohm

Part No.	PE3M0145	Cable Dia.	Attn. @ 1 GHz	Power @ 1 GHz
1 piece price shown. See web or call for volume pricing.				
12"	18"	24"	36"	48"
\$547.43	\$555.91	\$564.38	\$581.34	\$598.30

PE-P160LL-27478 Coax, 50 Ohm

Part No.	PE3M0190	Cable Dia.	Attn. @ 1 GHz	Power @ 1 GHz
1 piece price shown. See web or call for volume pricing.				
8"	12"	18"	24"	30"
\$548.55	\$553.44	\$560.80	\$568.15	\$575.50

Standard Formable Cable Assemblies

PE-SR405FLJ Coax, 50 Ohm

Part No.	PE39434	Cable Dia.	Attn. @ 1 GHz	Power @ 1 GHz
1 piece price shown. See web or call for volume pricing.				
6"	9"	12"	18"	24"
\$52.84	\$54.64	\$54.64	\$60.94	\$62.10

SMA FEMALE BULKHEAD TO SMA FEMALE

SEE MOUNTING HOLE SECTION ON PAGE 369



Standard Flexible Cable Assemblies

RG316/U Coax, 50 Ohm

Part No.	PE3W07334	Cable Dia.	Attn. @ 1 GHz	Power @ 1 GHz
1 piece price shown. See web or call for volume pricing.				
12"	24"	36"	48"	60"
\$49.30	\$52.57	\$55.86	\$59.14	\$62.42

SMA FEMALE BULKHEAD TO SMA FEMALE BULKHEAD

SEE MOUNTING HOLE SECTION ON PAGE 369



Low Loss Flexible Cable Assemblies

PE-P142LL-27478 Coax, 50 Ohm

Part No.	PE3M0144	Cable Dia.	Attn. @ 1 GHz	Power @ 1 GHz
1 piece price shown. See web or call for volume pricing.				
12"	18"	24"	36"	48"
\$546.68	\$555.16	\$563.64	\$580.59	\$597.55

PE-P160LL-27478 Coax, 50 Ohm

Part No.	PE3M0189	Cable Dia.	Attn. @ 1 GHz	Power @ 1 GHz
1 piece price shown. See web or call for volume pricing.				
8"	12"	18"	24"	30"
\$544.61	\$549.52	\$556.86	\$564.22	\$571.56

For Custom Lengths, Metric Lengths or Special Configurations, Please call (949) 261-1920

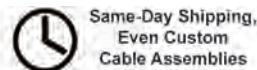
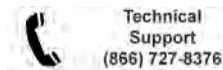

Cable Assemblies

See Our Website For Current Pricing & Real-Time Stock Availability!

For our complete selection of cable assemblies, please visit our website

Cable Assemblies
See Our Website For Current Pricing & Real-Time Stock Availability!

PE-P160LL Coax, 50 Ohm						
Part No. PE3C5247	Cable Dia.	Attn. @ 1 GHz	Power @ 1 GHz			
1 piece price shown. See web or call for volume pricing.						
12"	24"	36"	48"	60"	50CM	Custom Len.
\$239.46	\$284.75	\$276.68	\$297.07	\$317.48	\$248.93	See Web
Standard Formable Cable Assemblies						
PE-SR401FL Coax, 50 Ohm						
Part No. PE3794	Cable Dia.	Attn. @ 1 GHz	Power @ 1 GHz			
1 piece price shown. See web or call for volume pricing.						
6"	12"	18"	24"	36"	48"	Custom Len.
\$107.82	\$122.24	\$122.76	\$130.26	\$145.21	\$160.15	See Web
PE-SR402FL Coax, 50 Ohm						
Part No. PE33864	Cable Dia.	Attn. @ 1 GHz	Power @ 1 GHz			
1 piece price shown. See web or call for volume pricing.						
6"	12"	18"	24"	36"	48"	Custom Len.
\$71.62	\$71.62	\$75.80	\$79.97	\$88.33	\$96.68	See Web
PE-SR405FL Coax, 50 Ohm						
Part No. PE34070	Cable Dia.	Attn. @ 1 GHz	Power @ 1 GHz			
1 piece price shown. See web or call for volume pricing.						
6"	12"	18"	24"	36"	48"	Custom Len.
\$76.84	\$76.84	\$87.13	\$87.54	\$98.24	\$108.93	See Web
Standard Flexible Cable Assemblies						
RG58C/U Coax, 50 Ohm						
Part No. PE35404	Cable Dia.	Attn. @ 1 GHz	Power @ 1 GHz			
1 piece price shown. See web or call for volume pricing.						
12"	24"	36"	48"	60"	-	Custom Len.
\$56.29	\$57.03	\$57.76	\$64.41	\$59.22	-	See Web
RG174A/U Coax, 50 Ohm						
Part No. PE33382	Cable Dia.	Attn. @ 1 GHz	Power @ 1 GHz			
1 piece price shown. See web or call for volume pricing.						
12"	24"	36"	48"	60"	-	Custom Len.
\$52.91	\$53.44	\$53.92	\$54.45	\$54.94	-	See Web
RG178B/U Coax, 50 Ohm						
Part No. PE33084	Cable Dia.	Attn. @ 1 GHz	Power @ 1 GHz			
1 piece price shown. See web or call for volume pricing.						
12"	24"	36"	48"	60"	-	Custom Len.
\$70.88	\$71.85	\$77.25	\$78.37	\$74.71	-	See Web
RG316/U Coax, 50 Ohm						
Part No. PE33158	Cable Dia.	Attn. @ 1 GHz	Power @ 1 GHz			
1 piece price shown. See web or call for volume pricing.						
12"	24"	36"	48"	60"	-	Custom Len.
\$58.56	\$65.20	\$64.32	\$67.21	\$70.10	-	See Web
RG316-DS Coax, 50 Ohm						
Part No. PE38184	Cable Dia.	Attn. @ 1 GHz	Power @ 1 GHz			
1 piece price shown. See web or call for volume pricing.						
12"	24"	36"	48"	60"	-	Custom Len.
\$64.54	\$71.54	\$70.36	\$77.98	\$81.16	-	See Web
Standard Semi-Rigid Cable Assemblies						
PE-SR405AL Coax, 50 Ohm						
Part No. PE34071	Cable Dia.	Attn. @ 1 GHz	Power @ 1 GHz			
1 piece price shown. See web or call for volume pricing.						
6"	12"	18"	24"	36"	48"	Custom Len.
\$73.25	\$73.25	\$77.57	\$81.89	\$90.54	\$99.17	See Web
RG401/U Coax, 50 Ohm						
Part No. PE3634	Cable Dia.	Attn. @ 1 GHz	Power @ 1 GHz			
1 piece price shown. See web or call for volume pricing.						
6"	12"	18"	24"	36"	48"	Custom Len.
\$110.99	\$121.61	\$132.30	\$142.91	\$164.22	\$185.52	See Web
RG402/U Coax, 50 Ohm						
Part No. PE33518	Cable Dia.	Attn. @ 1 GHz	Power @ 1 GHz			
1 piece price shown. See web or call for volume pricing.						
6"	12"	18"	24"	36"	48"	Custom Len.
\$64.84	\$64.84	\$68.49	\$72.15	\$79.45	\$86.76	See Web
RG405/U Coax, 50 Ohm						
Part No. PE33176	Cable Dia.	Attn. @ 1 GHz	Power @ 1 GHz			
1 piece price shown. See web or call for volume pricing.						
6"	12"	18"	24"	36"	48"	Custom Len.
\$72.82	\$77.20	\$76.25	\$79.69	\$86.56	\$93.43	See Web
SMA FEMALE BULKHEAD TO REVERSE POLARITY SMA MALE						
SEE MOUNTING HOLE SECTION ON PAGE 369						
Standard Flexible Cable Assemblies						
RG141A/U Coax, 50 Ohm						
Part No. PE3W02965	Cable Dia.	Attn. @ 1 GHz	Power @ 1 GHz			
1 piece price shown. See web or call for volume pricing.						
12"	24"	36"	48"	60"	50CM	Custom Len.
\$70.05	\$77.43	\$84.80	\$92.18	\$99.56	\$74.78	See Web
SMA FEMALE BULKHEAD TO SMB PLUG RIGHT ANGLE						
SEE MOUNTING HOLE SECTION ON PAGE 369						
Low Loss Flexible Cable Assemblies						

PE-C100-LSZH Coax, 50 Ohm						
Part No. PE3W00135	Cable Dia.	Attn. @ 1 GHz	Power @ 1 GHz			
1 piece price shown. See web or call for volume pricing.						
12"	24"	36"	48"	60"	50CM	Custom Len.
\$42.53	\$43.81	\$45.10	\$46.39	\$47.68	\$43.36	See Web
SMA FEMALE BULKHEAD TO SMP FEMALE						
SEE MOUNTING HOLE SECTION ON PAGE 369						
Standard Flexible Cable Assemblies						
PE-P086 Coax, 50 Ohm						
Part No. PE3C5233	Cable Dia.	Attn. @ 1 GHz	Power @ 1 GHz			
1 piece price shown. See web or call for volume pricing.						
12"	24"	36"	48"	60"	50CM	Custom Len.
\$61.82	\$69.53	\$77.24	\$84.95	\$92.66	\$66.76	See Web
SMA FEMALE BULKHEAD TO SMP FEMALE RIGHT ANGLE						
SEE MOUNTING HOLE SECTION ON PAGE 369						
Low Loss Flexible Cable Assemblies						
LMR-100A-PVC Coax, 50 Ohm						
Part No. PE3C3937	Cable Dia.	Attn. @ 1 GHz	Power @ 1 GHz			
1 piece price shown. See web or call for volume pricing.						
12"	24"	36"	48"	60"	50CM	Custom Len.
\$48.24	\$48.98	\$49.72	\$50.45	\$51.19	\$48.72	See Web
SMA FEMALE BULKHEAD TO SSMC PLUG						
SEE MOUNTING HOLE SECTION ON PAGE 369						
Low Loss Flexible Cable Assemblies						
LMR-100A-PVC Coax, 50 Ohm						
Part No. PE3C4428	Cable Dia.	Attn. @ 1 GHz	Power @ 1 GHz			
1 piece price shown. See web or call for volume pricing.						
6"	12"	18"	24"	36"	48"	Custom Len.
\$49.38	\$53.84	\$51.16	\$53.58	\$52.26	\$59.19	See Web
Standard Formable Cable Assemblies						
PE-SR405FLJ Coax, 50 Ohm						
Part No. PE3C4448	Cable Dia.	Attn. @ 1 GHz	Power @ 1 GHz			
1 piece price shown. See web or call for volume pricing.						
6"	12"	18"	24"	36"	48"	Custom Len.
\$58.69	\$68.71	\$66.23	\$69.99	\$77.51	\$85.03	See Web
Standard Flexible Cable Assemblies						
RG178B/U Coax, 50 Ohm						
Part No. PE3C4395	Cable Dia.	Attn. @ 1 GHz	Power @ 1 GHz			
1 piece price shown. See web or call for volume pricing.						
6"	12"	18"	24"	36"	48"	Custom Len.
\$74.22	\$67.94	\$68.41	\$68.88	\$69.80	\$70.74	See Web
RG316/U Coax, 50 Ohm						
Part No. PE3C4411	Cable Dia.	Attn. @ 1 GHz	Power @ 1 GHz			
1 piece price shown. See web or call for volume pricing.						
6"	12"	18"	24"	36"	48"	Custom Len.
\$61.00	\$62.41	\$63.82	\$65.20	\$72.41	\$75.71	See Web
SMA FEMALE BULKHEAD TO SSMC PLUG RIGHT ANGLE						
SEE MOUNTING HOLE SECTION ON PAGE 369						
Low Loss Flexible Cable Assemblies						
LMR-100A-PVC Coax, 50 Ohm						
Part No. PE3C4429	Cable Dia.	Attn. @ 1 GHz	Power @ 1 GHz			
1 piece price shown. See web or call for volume pricing.						
6"	12"	18"	24"	36"	48"	Custom Len.
\$45.95	\$47.36	\$47.73	\$50.15	\$48.83	\$55.76	See Web
Standard Formable Cable Assemblies						
PE-SR405FLJ Coax, 50 Ohm						
Part No. PE3C4486	Cable Dia.	Attn. @ 1 GHz	Power @ 1 GHz			
1 piece price shown. See web or call for volume pricing.						
6"	12"	18"	24"	36"	48"	Custom Len.
\$55.60	\$59.37	\$63.13	\$73.84	\$74.41	\$81.94	See Web
Standard Flexible Cable Assemblies						
RG178B/U Coax, 50 Ohm						
Part No. PE3C4465	Cable Dia.	Attn. @ 1 GHz	Power @ 1 GHz			
1 piece price shown. See web or call for volume pricing.						
6"	12"	18"	24"	36"	48"	Custom Len.
\$59.06	\$59.52	\$59.99	\$60.46	\$61.39	\$62.32	See Web
RG316/U Coax, 50 Ohm						
Part No. PE3C4412	Cable Dia.	Attn. @ 1 GHz	Power @ 1 GHz			
1 piece price shown. See web or call for volume pricing.						
6"	12"	18"	24"	36"	48"	Custom Len.
\$57.57	\$58.97	\$64.08	\$61.77	\$64.58	\$67.38	See Web
RG316-DS Coax, 50 Ohm						

*Coax Performance at 1 GHz Notes: Cable assembly max frequency may be lower than connector or coax max frequency

For our complete selection of cable assemblies, please visit our website

Part No. PE3C4474	Cable Dia.				Attn. @ 1 GHz	Power @ 1 GHz
1 piece price shown. See web or call for volume pricing.						
6"	12"	18"	24"	36"	48"	Custom Len.
\$63.33	\$71.22	\$72.79	\$67.58	\$70.40	\$73.23	See Web

SMA FEMALE BULKHEAD TO TNC MALE

SEE MOUNTING HOLE SECTION ON PAGE 369

Low Loss Flexible Cable Assemblies

PE-P142LL-27478 Coax, 50 Ohm

Part No. PE3M0146	Cable Dia.				Attn. @ 1 GHz	Power @ 1 GHz
1 piece price shown. See web or call for volume pricing.						
12"	18"	24"	36"	48"	60"	Custom Len.
\$466.72	\$475.20	\$483.68	\$500.63	\$517.59	\$534.54	See Web

PE-P160LL-27478 Coax, 50 Ohm

Part No. PE3M0191	Cable Dia.				Attn. @ 1 GHz	Power @ 1 GHz
1 piece price shown. See web or call for volume pricing.						
8"	12"	18"	24"	30"	36"	Custom Len.
\$455.66	\$460.57	\$467.92	\$475.27	\$482.63	\$489.97	See Web

PE-P160LL Coax, 50 Ohm

Part No. PE3C5264	Cable Dia.				Attn. @ 1 GHz	Power @ 1 GHz
1 piece price shown. See web or call for volume pricing.						
12"	24"	36"	48"	60"	50CM	Custom Len.
\$222.45	\$243.17	\$263.87	\$284.59	\$305.30	\$235.72	See Web

SMA FEMALE BULKHEAD TO TNC MALE RIGHT ANGLE

SEE MOUNTING HOLE SECTION ON PAGE 369

Low Loss Flexible Cable Assemblies

PE-P142LL-27478 Coax, 50 Ohm

Part No. PE3M0148	Cable Dia.				Attn. @ 1 GHz	Power @ 1 GHz
1 piece price shown. See web or call for volume pricing.						
12"	18"	24"	36"	48"	60"	Custom Len.
\$573.40	\$581.88	\$590.36	\$607.32	\$624.27	\$641.23	See Web

PE-P160LL-27478 Coax, 50 Ohm

Part No. PE3M0193	Cable Dia.				Attn. @ 1 GHz	Power @ 1 GHz
1 piece price shown. See web or call for volume pricing.						
8"	12"	18"	24"	30"	36"	Custom Len.
\$540.67	\$545.58	\$552.92	\$560.28	\$567.63	\$574.98	See Web

PE-P160LL Coax, 50 Ohm

Part No. PE3C5265	Cable Dia.				Attn. @ 1 GHz	Power @ 1 GHz
1 piece price shown. See web or call for volume pricing.						
12"	24"	36"	48"	60"	50CM	Custom Len.
\$281.22	\$243.17	\$263.87	\$284.59	\$305.30	\$235.72	See Web

SMA FEMALE BULKHEAD TO TNC FEMALE BULKHEAD

SEE MOUNTING HOLE SECTION ON PAGE 369

Low Loss Flexible Cable Assemblies

PE-P142LL-27478 Coax, 50 Ohm

Part No. PE3M0147	Cable Dia.				Attn. @ 1 GHz	Power @ 1 GHz
1 piece price shown. See web or call for volume pricing.						
12"	18"	24"	36"	48"	60"	Custom Len.
\$545.81	\$554.05	\$562.52	\$579.48	\$596.44	\$613.39	See Web

PE-P160LL-27478 Coax, 50 Ohm

Part No. PE3M0192	Cable Dia.				Attn. @ 1 GHz	Power @ 1 GHz
1 piece price shown. See web or call for volume pricing.						
8"	12"	18"	24"	30"	36"	Custom Len.
\$536.74	\$541.64	\$549.00	\$556.34	\$563.70	\$571.04	See Web

PE-P160LL Coax, 50 Ohm

Part No. PE3C5266	Cable Dia.				Attn. @ 1 GHz	Power @ 1 GHz
1 piece price shown. See web or call for volume pricing.						
12"	24"	36"	48"	60"	50CM	Custom Len.
\$248.74	\$269.45	\$290.16	\$310.87	\$331.59	\$262.00	See Web

SMA FEMALE BULKHEAD TO HMCX32 1.2 PLUG

SEE MOUNTING HOLE SECTION ON PAGE 369

Standard Flexible Cable Assemblies

PE-81mm Coax, 50 Ohm

Part No. PE3CA1007	Cable Dia.				Attn. @ 1 GHz	Power @ 1 GHz
1 piece price shown. See web or call for volume pricing.						
3"	6"	12"	-	-	-	Custom Len.
\$13.92	\$12.93	\$12.93	-	-	-	See Web

SMA FEMALE BULKHEAD TO UMCX PLUG RIGHT ANGLE

SEE MOUNTING HOLE SECTION ON PAGE 369

Standard Flexible Cable Assemblies

RG178B/U Coax, 50 Ohm

Part No. PE3E299	Cable Dia.				Attn. @ 1 GHz	Power @ 1 GHz
1 piece price shown. See web or call for volume pricing.						
3"	6"	9"	12"	18"	24"	Custom Len.
\$66.75	\$68.46	\$70.17	\$71.89	\$75.42	\$76.48	See Web

SMA FEMALE BULKHEAD TO UMCX 2.1 PLUG

SEE MOUNTING HOLE SECTION ON PAGE 369

Standard Flexible Cable Assemblies

PE-81mm Coax, 50 Ohm

Part No. PE3CA1005	Cable Dia.				Attn. @ 1 GHz	Power @ 1 GHz
1 piece price shown. See web or call for volume pricing.						
3"	6"	12"	-	-	-	Custom Len.
\$11.21	\$12.93	\$12.33	-	-	-	See Web

SMA FEMALE BULKHEAD TO UMCX 2.5 PLUG

SEE MOUNTING HOLE SECTION ON PAGE 369

Standard Flexible Cable Assemblies

RG178B/U Coax, 50 Ohm

Part No. PE3CA1003	Cable Dia.				Attn. @ 1 GHz	Power @ 1 GHz
1 piece price shown. See web or call for volume pricing.						
6"	9"	12"	-	-	-	Custom Len.
\$12.93	\$12.93	\$11.88	-	-	-	See Web

RG178-DS Coax, 50 Ohm

Part No. PE3CA1004	Cable Dia.				Attn. @ 1 GHz	Power @ 1 GHz
1 piece price shown. See web or call for volume pricing.						
6"	9"	12"	-	-	-	Custom Len.
\$13.42	\$13.60	\$14.05	-	-	-	See Web

PE-81mm Coax, 50 Ohm

Part No. PE3CA1000	Cable Dia.				Attn. @ 1 GHz	Power @ 1 GHz
1 piece price shown. See web or call for volume pricing.						
3"	6"	12"	-	-	-	Custom Len.
\$12.93	\$11.44	\$12.93	-	-	-	See Web

PE-113mm Coax, 50 Ohm

Part No. PE3CA1001	Cable Dia.				Attn. @ 1 GHz	Power @ 1 GHz
1 piece price shown. See web or call for volume pricing.						
3"	6"	9"	12"	-	-	Custom Len.
\$14.28	\$12.38	\$12.56	\$12.38	-	-	See Web

PE-137mm Coax, 50 Ohm

Part No. PE3CA1002	Cable Dia.				Attn. @ 1 GHz	Power @ 1 GHz
1 piece price shown. See web or call for volume pricing.						
3"	6"	12"	-	-	-	Custom Len.
\$12.93	\$13.51	\$12.93	-	-	-	See Web

SMA FEMALE BULKHEAD TO WMCX 1.6 PLUG

SEE MOUNTING HOLE SECTION ON PAGE 369

Standard Flexible Cable Assemblies

PE-81mm Coax, 50 Ohm

Part No. PE3CA1006	Cable Dia.				Attn. @ 1 GHz	Power @ 1 GHz
1 piece price shown. See web or call for volume pricing.						
3"	6"	12"	-	-	-	Custom Len.
\$11.21	\$12.93	\$12.93	-	-	-	See Web

REVERSE POLARITY SMA FEMALE BULKHEAD TO SMA MALE

SEE MOUNTING HOLE SECTION ON PAGE 369

Standard Formable Cable Assemblies

PE-SR405FLJ Coax, 50 Ohm

Part No. PE3W04623	Cable Dia.				Attn. @ 1 GHz	Power @ 1 GHz
1 piece price shown. See web or call for volume pricing.						
12"	24"	36"	48"	60"	50CM	Custom Len.
\$68.32	\$77.27	\$86.23	\$95.18	\$104.14	\$74.06	See Web

REVERSE POLARITY SMA FEMALE BULKHEAD TO SMA MALE RIGHT ANGLE

SEE MOUNTING HOLE SECTION ON PAGE 369

Standard Formable Cable Assemblies

PE-SR405FLJ Coax, 50 Ohm

Part No. PE3W04625	Cable Dia.				Attn. @ 1 GHz	Power @ 1 GHz
1 piece price shown. See web or call for volume pricing.						
12"	24"	36"	48"	60"	50CM	Custom Len.
\$89.00	\$97.95	\$106.90	\$115.86	\$124.82	\$94.74	See Web

REVERSE POLARITY SMA FEMALE BULKHEAD TO HMCX32 1.2 PLUG

SEE MOUNTING HOLE SECTION ON PAGE 369

Standard Flexible Cable Assemblies

Cable Assemblies

See Our Website For Current Pricing & Real-Time Stock Availability!

Continued on Next Page

For Custom Lengths, Metric Lengths or Special Configurations, Please call (949) 261-1920

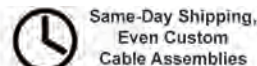
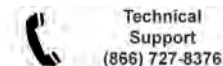

For our complete selection of cable assemblies, please visit our website

Cable Assemblies

See Our Website For Current Pricing & Real-Time Stock Availability!

PE-81mm Coax, 50 Ohm						
Part No. PE3CA1022	Cable Dia.	Attn. @ 1 GHz	Power @ 1GHz			
1 piece price shown. See web or call for volume pricing.						
3"	6"	12"	-	-	-	Custom Len.
\$12.93	\$12.93	\$12.38	-	-	-	See Web
REVERSE POLARITY SMA FEMALE BULKHEAD TO UMCX PLUG SEE MOUNTING HOLE SECTION ON PAGE 369						
Standard Flexible Cable Assemblies						
RG178B/U Coax, 50 Ohm						
Part No. PE38300	Cable Dia.	Attn. @ 1 GHz	Power @ 1GHz			
1 piece price shown. See web or call for volume pricing.						
3"	6"	9"	12"	18"	24"	Custom Len.
\$55.12	\$55.12	\$55.12	\$55.12	\$58.81	\$65.49	See Web
REVERSE POLARITY SMA FEMALE BULKHEAD TO UMCX 2.1 PLUG SEE MOUNTING HOLE SECTION ON PAGE 369						
Standard Flexible Cable Assemblies						
PE-81mm Coax, 50 Ohm						
Part No. PE3CA1033	Cable Dia.	Attn. @ 1 GHz	Power @ 1GHz			
1 piece price shown. See web or call for volume pricing.						
3"	6"	12"	-	-	-	Custom Len.
\$12.93	\$14.28	\$12.93	-	-	-	See Web
REVERSE POLARITY SMA FEMALE BULKHEAD TO UMCX 2.5 PLUG SEE MOUNTING HOLE SECTION ON PAGE 369						
Standard Flexible Cable Assemblies						
RG178B/U Coax, 50 Ohm						
Part No. PE3CA1019	Cable Dia.	Attn. @ 1 GHz	Power @ 1GHz			
1 piece price shown. See web or call for volume pricing.						
6"	9"	12"	-	-	-	Custom Len.
\$11.21	\$12.33	\$12.93	-	-	-	See Web
Standard Flexible Cable Assemblies						
RG178-DS Coax, 50 Ohm						
Part No. PE3CA1020	Cable Dia.	Attn. @ 1 GHz	Power @ 1GHz			
1 piece price shown. See web or call for volume pricing.						
6"	9"	12"	-	-	-	Custom Len.
\$14.05	\$14.05	\$11.21	-	-	-	See Web
Standard Flexible Cable Assemblies						
PE-81mm Coax, 50 Ohm						
Part No. PE3CA1016	Cable Dia.	Attn. @ 1 GHz	Power @ 1GHz			
1 piece price shown. See web or call for volume pricing.						
3"	6"	12"	-	-	-	Custom Len.
\$11.21	\$12.93	\$11.21	-	-	-	See Web
Standard Flexible Cable Assemblies						
PE-113mm Coax, 50 Ohm						
Part No. PE3CA1017	Cable Dia.	Attn. @ 1 GHz	Power @ 1GHz			
1 piece price shown. See web or call for volume pricing.						
3"	6"	12"	-	-	-	Custom Len.
\$12.93	\$12.93	\$12.93	-	-	-	See Web
Standard Flexible Cable Assemblies						
PE-137mm Coax, 50 Ohm						
Part No. PE3CA1018	Cable Dia.	Attn. @ 1 GHz	Power @ 1GHz			
1 piece price shown. See web or call for volume pricing.						
3"	6"	12"	-	-	-	Custom Len.
\$12.93	\$12.93	\$12.93	-	-	-	See Web
REVERSE POLARITY SMA FEMALE BULKHEAD TO WMCX 1.6 PLUG SEE MOUNTING HOLE SECTION ON PAGE 369						
Standard Flexible Cable Assemblies						
PE-81mm Coax, 50 Ohm						
Part No. PE3CA1021	Cable Dia.	Attn. @ 1 GHz	Power @ 1GHz			
1 piece price shown. See web or call for volume pricing.						
3"	6"	12"	-	-	-	Custom Len.
\$11.21	\$11.21	\$12.93	-	-	-	See Web
SMA FEMALE 2 HOLE FLANGE TO SMA FEMALE 2 HOLE FLANGE SEE MOUNTING HOLE SECTION ON PAGE 369						
Standard Formable Cable Assemblies						
PE-SR047FL Coax, 50 Ohm						
Part No. PE35154	Cable Dia.	Attn. @ 1 GHz	Power @ 1GHz			
1 piece price shown. See web or call for volume pricing.						
6"	12"	18"	24"	36"	48"	Custom Len.
\$87.11	\$95.82	\$90.80	\$94.49	\$101.86	\$109.22	See Web
Standard Flexible Cable Assemblies						
PE-SR402FL Coax, 50 Ohm						
Part No. PE35108	Cable Dia.	Attn. @ 1 GHz	Power @ 1GHz			
1 piece price shown. See web or call for volume pricing.						
6"	12"	18"	24"	36"	48"	Custom Len.
\$76.84	\$80.44	\$84.11	\$87.76	\$95.09	\$102.35	See Web
Standard Flexible Cable Assemblies						
PE-SR405FL Coax, 50 Ohm						
Part No. PE35150	Cable Dia.	Attn. @ 1 GHz	Power @ 1GHz			
1 piece price shown. See web or call for volume pricing.						
6"	12"	18"	24"	36"	48"	Custom Len.
\$87.11	\$95.82	\$90.80	\$94.49	\$101.86	\$109.22	See Web

PE-047SR Coax, 50 Ohm						
Part No. PE35114	Cable Dia.	Attn. @ 1 GHz	Power @ 1GHz			
1 piece price shown. See web or call for volume pricing.						
6"	12"	18"	24"	36"	48"	Custom Len.
\$68.08	\$73.24	\$78.40	\$83.62	\$100.33	\$104.33	See Web
Standard Semi-Rigid Cable Assemblies						
PE-047SR Coax, 50 Ohm						
Part No. PE35064	Cable Dia.	Attn. @ 1 GHz	Power @ 1GHz			
1 piece price shown. See web or call for volume pricing.						
6"	12"	18"	24"	36"	48"	Custom Len.
\$90.08	\$95.45	\$95.17	\$106.52	\$110.52	\$120.76	See Web
Standard Flexible Cable Assemblies						
RG402/U Coax, 50 Ohm						
Part No. PE3525	Cable Dia.	Attn. @ 1 GHz	Power @ 1GHz			
1 piece price shown. See web or call for volume pricing.						
6"	12"	18"	24"	36"	48"	Custom Len.
\$76.72	\$80.26	\$83.81	\$96.11	\$94.43	\$101.50	See Web
Standard Flexible Cable Assemblies						
RG405/U Coax, 50 Ohm						
Part No. PE33191	Cable Dia.	Attn. @ 1 GHz	Power @ 1GHz			
1 piece price shown. See web or call for volume pricing.						
6"	12"	18"	24"	36"	48"	Custom Len.
\$77.45	\$81.05	\$77.12	\$80.55	\$87.43	\$94.29	See Web
SMA FEMALE 2 HOLE FLANGE TO SMP FEMALE SEE MOUNTING HOLE SECTION ON PAGE 369						
Standard Semi-Rigid Cable Assemblies						
PE-047SR Coax, 50 Ohm						
Part No. PE3W05930	Cable Dia.	Attn. @ 1 GHz	Power @ 1GHz			
1 piece price shown. See web or call for volume pricing.						
12"	24"	36"	48"	60"	50CM	Custom Len.
\$107.53	\$101.09	\$111.84	\$122.58	\$133.32	\$97.23	See Web
SMA FEMALE 2 HOLE FLANGE TO SMP FEMALE RIGHT ANGLE SEE MOUNTING HOLE SECTION ON PAGE 369						
Standard Formable Cable Assemblies						
PE-SR405FLJ Coax, 50 Ohm						
Part No. PE3W05557	Cable Dia.	Attn. @ 1 GHz	Power @ 1GHz			
1 piece price shown. See web or call for volume pricing.						
12"	24"	36"	48"	60"	50CM	Custom Len.
\$107.85	\$116.83	\$125.80	\$134.78	\$143.76	\$113.63	See Web
SMA FEMALE 4 HOLE FLANGE TO MMCX PLUG RIGHT ANGLE SEE MOUNTING HOLE SECTION ON PAGE 369						
Low Loss Flexible Cable Assemblies						
LMR-100A-PVC Coax, 50 Ohm						
Part No. PE3C0064	Cable Dia.	Attn. @ 1 GHz	Power @ 1GHz			
1 piece price shown. See web or call for volume pricing.						
12"	24"	36"	48"	60"	-	Custom Len.
\$92.30	\$93.05	\$93.81	\$94.57	\$95.33	-	See Web
SMA FEMALE 4 HOLE FLANGE TO SMA FEMALE 4 HOLE FLANGE SEE MOUNTING HOLE SECTION ON PAGE 369						
Standard Formable Cable Assemblies						
PE-SR047FL Coax, 50 Ohm						
Part No. PE35112	Cable Dia.	Attn. @ 1 GHz	Power @ 1GHz			
1 piece price shown. See web or call for volume pricing.						
6"	12"	18"	24"	36"	48"	Custom Len.
\$104.08	\$103.54	\$107.10	\$110.68	\$117.83	\$124.98	See Web
Standard Flexible Cable Assemblies						
PE-SR402FL Coax, 50 Ohm						
Part No. PE35110	Cable Dia.	Attn. @ 1 GHz	Power @ 1GHz			
1 piece price shown. See web or call for volume pricing.						
6"	12"	18"	24"	36"	48"	Custom Len.
\$91.85	\$95.52	\$99.17	\$102.82	\$110.09	\$117.42	See Web
Standard Flexible Cable Assemblies						
PE-SR405FL Coax, 50 Ohm						
Part No. PE35116	Cable Dia.	Attn. @ 1 GHz	Power @ 1GHz			
1 piece price shown. See web or call for volume pricing.						
6"	12"	18"	24"	36"	48"	Custom Len.
\$96.43	\$102.22	\$101.76	\$107.11	\$117.81	\$128.50	See Web
Standard Semi-Rigid Cable Assemblies						
PE-047SR Coax, 50 Ohm						
Part No. PE35118	Cable Dia.	Attn. @ 1 GHz	Power @ 1GHz			
1 piece price shown. See web or call for volume pricing.						
6"	12"	18"	24"	36"	48"	Custom Len.
\$112.70	\$119.46	\$124.99	\$122.92	\$133.17	\$143.40	See Web
Standard Flexible Cable Assemblies						
RG402/U Coax, 50 Ohm						
Part No. PE33502	Cable Dia.	Attn. @ 1 GHz	Power @ 1GHz			
1 piece price shown. See web or call for volume pricing.						
6"	12"	18"	24"	36"	48"	Custom Len.
\$101.04	\$101.04	\$104.70	\$114.92	\$122.75	\$131.03	See Web

*Coax Performance at 1 GHz Notes: Cable assembly max frequency may be lower than connector or coax max frequency

For our complete selection of cable assemblies, please visit our website

RG405/U Coax, 50 Ohm						
Part No. PE3223	Cable Dia.			Attn. @ 1 GHz	Power @ 1 GHz	
1 piece price shown. See web or call for volume pricing.						
6"	12"	18"	24"	36"	48"	Custom Len.
\$100.48	\$100.48	\$110.23	\$113.94	\$114.23	\$121.09	See Web

SMB PLUG TO BNC MALE



Standard Flexible Cable Assemblies

RG58C/U Coax, 50 Ohm						
Part No. PE3242	Cable Dia.			Attn. @ 1 GHz	Power @ 1 GHz	
1 piece price shown. See web or call for volume pricing.						
12"	24"	36"	48"	60"	72"	Custom Len.
\$48.53	\$49.35	\$50.16	\$51.03	\$51.86	\$52.68	See Web

RG142B/U Coax, 50 Ohm						
Part No. PE3349	Cable Dia.			Attn. @ 1 GHz	Power @ 1 GHz	
1 piece price shown. See web or call for volume pricing.						
12"	24"	36"	48"	60"	72"	Custom Len.
\$47.62	\$53.70	\$59.78	\$66.22	\$67.85	\$78.60	See Web

RG174A/U Coax, 50 Ohm						
Part No. PE3C3318	Cable Dia.			Attn. @ 1 GHz	Power @ 1 GHz	
1 piece price shown. See web or call for volume pricing.						
12"	24"	36"	48"	60"	72"	Custom Len.
\$37.91	\$38.49	\$39.08	\$39.68	\$40.27	\$40.86	See Web

RG178B/U Coax, 50 Ohm						
Part No. PE33825	Cable Dia.			Attn. @ 1 GHz	Power @ 1 GHz	
1 piece price shown. See web or call for volume pricing.						
12"	24"	36"	48"	60"	-	Custom Len.
\$59.06	\$60.12	\$61.18	\$62.30	\$63.38	-	See Web

RG188A/U Coax, 50 Ohm						
Part No. PE3C3428	Cable Dia.			Attn. @ 1 GHz	Power @ 1 GHz	
1 piece price shown. See web or call for volume pricing.						
12"	24"	36"	48"	60"	72"	Custom Len.
\$42.78	\$49.55	\$47.22	\$54.68	\$57.22	\$59.76	See Web

RG223/U Coax, 50 Ohm						
Part No. PE3236	Cable Dia.			Attn. @ 1 GHz	Power @ 1 GHz	
1 piece price shown. See web or call for volume pricing.						
12"	24"	36"	48"	60"	72"	Custom Len.
\$44.57	\$47.68	\$50.80	\$54.09	\$57.27	\$60.45	See Web

PE-P195 Coax, 50 Ohm						
Part No. PE37250	Cable Dia.			Attn. @ 1 GHz	Power @ 1 GHz	
1 piece price shown. See web or call for volume pricing.						
12"	24"	36"	48"	60"	-	Custom Len.
\$53.07	\$62.65	\$67.77	\$76.63	\$85.48	-	See Web

SMB PLUG TO N FEMALE



Standard Flexible Cable Assemblies

RG141A/U Coax, 50 Ohm						
Part No. PE3W04161	Cable Dia.			Attn. @ 1 GHz	Power @ 1 GHz	
1 piece price shown. See web or call for volume pricing.						
12"	24"	36"	48"	60"	50CM	Custom Len.
\$57.50	\$64.88	\$72.25	\$79.63	\$87.01	\$62.23	See Web

SMB PLUG TO SMB PLUG



Standard Flexible Cable Assemblies

PE-B100 Coax, 50 Ohm						
Part No. PE34488	Cable Dia.			Attn. @ 1 GHz	Power @ 1 GHz	
1 piece price shown. See web or call for volume pricing.						
12"	24"	36"	48"	60"	72"	Custom Len.
\$48.33	\$60.26	\$67.36	\$68.92	\$75.75	\$82.65	See Web

RG58C/U Coax, 50 Ohm						
Part No. PE33650	Cable Dia.			Attn. @ 1 GHz	Power @ 1 GHz	
1 piece price shown. See web or call for volume pricing.						
12"	24"	36"	48"	60"	72"	Custom Len.
\$58.27	\$63.74	\$64.55	\$60.47	\$61.21	\$61.93	See Web

RG142B/U Coax, 50 Ohm						
Part No. PE33652	Cable Dia.			Attn. @ 1 GHz	Power @ 1 GHz	
1 piece price shown. See web or call for volume pricing.						
12"	24"	36"	48"	60"	72"	Custom Len.
\$50.67	\$61.82	\$67.90	\$67.31	\$72.88	\$86.73	See Web

RG174A/U Coax, 50 Ohm						
Part No. PE3853	Cable Dia.			Attn. @ 1 GHz	Power @ 1 GHz	
1 piece price shown. See web or call for volume pricing.						
12"	24"	36"	48"	60"	72"	Custom Len.
\$44.45	\$44.88	\$45.31	\$45.75	\$46.18	\$46.62	See Web

RG178B/U Coax, 50 Ohm						
Part No. PE33672	Cable Dia.			Attn. @ 1 GHz	Power @ 1 GHz	
1 piece price shown. See web or call for volume pricing.						
12"	24"	36"	48"	60"	72"	Custom Len.
\$53.74	\$56.74	\$59.74	\$62.73	\$65.73	\$68.74	See Web

RG188A/U Coax, 50 Ohm						
Part No. PE33165	Cable Dia.			Attn. @ 1 GHz	Power @ 1 GHz	
1 piece price shown. See web or call for volume pricing.						
12"	24"	36"	48"	60"	72"	Custom Len.
\$56.94	\$58.00	\$59.06	\$56.59	\$61.26	\$62.34	See Web

RG188-DS Coax, 50 Ohm						
Part No. PE3587	Cable Dia.			Attn. @ 1 GHz	Power @ 1 GHz	
1 piece price shown. See web or call for volume pricing.						
12"	24"	36"	48"	60"	72"	Custom Len.
\$50.87	\$53.36	\$51.53	\$53.76	\$55.98	\$63.58	See Web

RG196A/U Coax, 50 Ohm						
Part No. PE3721	Cable Dia.			Attn. @ 1 GHz	Power @ 1 GHz	
1 piece price shown. See web or call for volume pricing.						
12"	24"	36"	48"	60"	72"	Custom Len.
\$48.32	\$51.72	\$55.12	\$58.54	\$61.93	\$65.33	See Web

RG223/U Coax, 50 Ohm						
Part No. PE3166	Cable Dia.			Attn. @ 1 GHz	Power @ 1 GHz	
1 piece price shown. See web or call for volume pricing.						
12"	24"	36"	48"	60"	72"	Custom Len.
\$56.00	\$59.12	\$62.24	\$61.54	\$64.43	\$67.34	See Web

RG316/U Coax, 50 Ohm						
Part No. PE3915	Cable Dia.			Attn. @ 1 GHz	Power @ 1 GHz	
1 piece price shown. See web or call for volume pricing.						
12"	24"	36"	48"	60"	72"	Custom Len.
\$50.88	\$54.00	\$57.12	\$60.44	\$63.62	\$66.81	See Web

RG316-DS Coax, 50 Ohm						
Part No. PE33704	Cable Dia.			Attn. @ 1 GHz	Power @ 1 GHz	
1 piece price shown. See web or call for volume pricing.						
12"	24"	36"	48"	60"	72"	Custom Len.
\$49.83	\$52.96	\$56.09	\$56.66	\$59.58	\$65.77	See Web

RG400/U Coax, 50 Ohm						
Part No. PE34269	Cable Dia.			Attn. @ 1 GHz	Power @ 1 GHz	
1 piece price shown. See web or call for volume pricing.						
12"	24"	36"	48"	60"	72"	Custom Len.
\$63.99	\$71.39	\$72.23	\$79.23	\$94.14	\$93.28	See Web

SMB PLUG TO SMB PLUG RIGHT ANGLE



Standard Flexible Cable Assemblies

PE-B100 Coax, 50 Ohm						
Part No. PE34490	Cable Dia.			Attn. @ 1 GHz	Power @ 1 GHz	
1 piece price shown. See web or call for volume pricing.						
12"	24"	36"	48"	60"	72"	Custom Len.
\$51.63	\$58.47	\$65.32	\$72.23	\$79.07	\$85.96	See Web

RG58C/U Coax, 50 Ohm						
Part No. PE33666	Cable Dia.			Attn. @ 1 GHz	Power @ 1 GHz	
1 piece price shown. See web or call for volume pricing.						
12"	24"	36"	48"	60"	72"	Custom Len.
\$60.44	\$61.18	\$61.91	\$62.65	\$63.38	\$64.12	See Web

RG174A/U Coax, 50 Ohm						
Part No. PE33175	Cable Dia.			Attn. @ 1 GHz	Power @ 1 GHz	
1 piece price shown. See web or call for volume pricing.						
12"	24"	36"	48"	60"	72"	Custom Len.
\$55.32	\$55.75	\$56.18	\$62.62	\$63.20	\$63.79	See Web

RG178B/U Coax, 50 Ohm						
Part No. PE33356	Cable Dia.			Attn. @ 1 GHz	Power @ 1 GHz	
1 piece price shown. See web or call for volume pricing.						
12"	24"	36"	48"	60"	72"	Custom Len.
\$63.49	\$64.44	\$65.41	\$66.37	\$67.33	\$68.28	See Web

RG188A/U Coax, 50 Ohm						
Part No. PE3592	Cable Dia.			Attn. @ 1 GHz	Power @ 1 GHz	
1 piece price shown. See web or call for volume pricing.						
12"	24"	36"	48"	60"	72"	Custom Len.
\$52.91	\$54.99	\$57.16	\$59.32	\$61.43	\$63.58	See Web

RG188-DS Coax, 50 Ohm						
Part No. PE33143	Cable Dia.			Attn. @ 1 GHz	Power @ 1 GHz	
1 piece price shown. See web or call for volume pricing.						
12"	24"	36"	48"	60"	72"	Custom Len.
\$58.37	\$61.77	\$65.17	\$68.56	\$71.97	\$75.38	See Web

RG223/U Coax, 50 Ohm						
Part No. PE33670	Cable Dia.			Attn. @ 1 GHz	Power @ 1 GHz	
1 piece price shown. See web or call for volume pricing.						
12"	24"	36"	48"	60"	72"	Custom Len.
\$51.16	\$54.04	\$61.48	\$59.86	\$62.80	\$65.73	See Web

RG316/U Coax, 50 Ohm						
Part No. PE33672	Cable Dia.			Attn. @ 1 GHz	Power @ 1 GHz	
1 piece price shown. See web or call for volume pricing.						
12"	24"	36"	48"	60"	72"	Custom Len.
\$53.74	\$56.74	\$59.74	\$62.73	\$65.73	\$68.74	See Web

Cable Assemblies

See Our Website For Current Pricing & Real-Time Stock Availability!

For Custom Lengths, Metric Lengths or Special Configurations, Please call (949) 261-1920

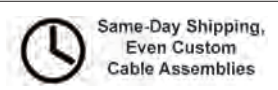

For our complete selection of cable assemblies, please visit our website

Cable Assemblies

See Our Website For Current Pricing & Real-Time Stock Availability!

RG316-DS Coax, 50 Ohm						
Part No. PE34485	Cable Dia.			Attn. @ 1 GHz	Power @ 1 GHz	
1 piece price shown. See web or call for volume pricing.	0.114" dia.			26 dB/100ft	160 W	71
12"	24"	36"	48"	60"	72"	Custom Len.
\$57.98	\$60.90	\$63.80	\$72.17	\$69.62	\$72.53	See Web

RG400/U Coax, 50 Ohm						
Part No. PE34481	Cable Dia.			Attn. @ 1 GHz	Power @ 1 GHz	
1 piece price shown. See web or call for volume pricing.	0.195" dia.			15 dB/100ft	650 W	72
12"	24"	36"	48"	60"	72"	Custom Len.
\$67.23	\$74.27	\$81.28	\$88.32	\$95.32	\$102.35	See Web

SMB PLUG TO SMB JACK BULKHEAD

SEE MOUNTING HOLE SECTION ON PAGE 369



Standard Flexible Cable Assemblies

PE-B100 Coax, 50 Ohm						
Part No. PE34491	Cable Dia.			Attn. @ 1 GHz	Power @ 1 GHz	
1 piece price shown. See web or call for volume pricing.	0.101" dia.			dB/100ft	W	73
12"	24"	36"	48"	60"	72"	Custom Len.
\$51.34	\$58.23	\$65.07	\$71.93	\$78.82	\$85.66	See Web

RG142B/U Coax, 50 Ohm						
Part No. PE34495	Cable Dia.			Attn. @ 1 GHz	Power @ 1 GHz	
1 piece price shown. See web or call for volume pricing.	0.195" dia.			13 dB/100ft	650 W	74
12"	24"	36"	48"	60"	72"	Custom Len.
\$63.76	\$76.22	\$74.81	\$80.38	\$85.90	\$91.48	See Web

RG174A/U Coax, 50 Ohm						
Part No. PE33674	Cable Dia.			Attn. @ 1 GHz	Power @ 1 GHz	
1 piece price shown. See web or call for volume pricing.	0.100" dia.			32 dB/100ft	16 W	75
12"	24"	36"	48"	60"	72"	Custom Len.
\$51.42	\$52.00	\$49.38	\$53.19	\$53.78	\$50.68	See Web

RG178B/U Coax, 50 Ohm						
Part No. PE33676	Cable Dia.			Attn. @ 1 GHz	Power @ 1 GHz	
1 piece price shown. See web or call for volume pricing.	0.072" dia.			44 dB/100ft	78 W	76
12"	24"	36"	48"	60"	72"	Custom Len.
\$57.23	\$53.96	\$54.90	\$55.87	\$56.82	\$62.63	See Web

RG188A/U Coax, 50 Ohm						
Part No. PE3591	Cable Dia.			Attn. @ 1 GHz	Power @ 1 GHz	
1 piece price shown. See web or call for volume pricing.	0.110" dia.			26 dB/100ft	160 W	77
12"	24"	36"	48"	60"	72"	Custom Len.
\$46.59	\$53.74	\$50.92	\$53.01	\$55.18	\$57.28	See Web

RG188-DS Coax, 50 Ohm						
Part No. PE34489	Cable Dia.			Attn. @ 1 GHz	Power @ 1 GHz	
1 piece price shown. See web or call for volume pricing.	0.122" dia.			30 dB/100ft	160 W	78
12"	24"	36"	48"	60"	72"	Custom Len.
\$55.76	\$59.27	\$58.42	\$61.82	\$65.23	\$68.63	See Web

RG196A/U Coax, 50 Ohm						
Part No. PE3130	Cable Dia.			Attn. @ 1 GHz	Power @ 1 GHz	
1 piece price shown. See web or call for volume pricing.	0.080" dia.			49 dB/100ft	78 W	79
12"	24"	36"	48"	60"	72"	Custom Len.
\$53.39	\$58.01	\$56.13	\$57.51	\$58.87	\$60.24	See Web

RG223/U Coax, 50 Ohm						
Part No. PE34497	Cable Dia.			Attn. @ 1 GHz	Power @ 1 GHz	
1 piece price shown. See web or call for volume pricing.	0.210" dia.			13 dB/100ft	53 W	80
12"	24"	36"	48"	60"	72"	Custom Len.
\$61.12	\$64.00	\$66.94	\$69.88	\$72.77	\$75.70	See Web

RG316/U Coax, 50 Ohm						
Part No. PE33680	Cable Dia.			Attn. @ 1 GHz	Power @ 1 GHz	
1 piece price shown. See web or call for volume pricing.	0.098" dia.			38 dB/100ft	160 W	81
12"	24"	36"	48"	60"	72"	Custom Len.
\$57.47	\$60.59	\$63.71	\$60.91	\$63.79	\$66.68	See Web

RG316-DS Coax, 50 Ohm						
Part No. PE34487	Cable Dia.			Attn. @ 1 GHz	Power @ 1 GHz	
1 piece price shown. See web or call for volume pricing.	0.114" dia.			26 dB/100ft	160 W	82
12"	24"	36"	48"	60"	72"	Custom Len.
\$57.40	\$55.09	\$58.00	\$60.92	\$63.83	\$66.73	See Web

RG400/U Coax, 50 Ohm						
Part No. PE34483	Cable Dia.			Attn. @ 1 GHz	Power @ 1 GHz	
1 piece price shown. See web or call for volume pricing.	0.195" dia.			15 dB/100ft	650 W	83
12"	24"	36"	48"	60"	72"	Custom Len.
\$71.20	\$78.24	\$85.24	\$92.25	\$99.30	\$106.31	See Web

SMB PLUG RIGHT ANGLE TO BNC MALE



Standard Flexible Cable Assemblies

RG223/U Coax, 50 Ohm						
Part No. PE3W06905	Cable Dia.			Attn. @ 1 GHz	Power @ 1 GHz	
1 piece price shown. See web or call for volume pricing.	0.209" dia.			13 dB/100ft	50 W	84
12"	24"	36"	48"	60"	50CM	Custom Len.
\$43.59	\$46.83	\$50.07	\$53.31	\$56.55	\$45.65	See Web

SMB PLUG RIGHT ANGLE TO SMB PLUG RIGHT ANGLE



Low Loss Flexible Cable Assemblies

PE-C195 Coax, 50 Ohm						
Part No. PE39120	Cable Dia.			Attn. @ 1 GHz	Power @ 1 GHz	
1 piece price shown. See web or call for volume pricing.	0.195" dia.			11 dB/100ft	150 W	85
12"	24"	36"	48"	60"	-	Custom Len.
\$53.56	\$54.34	\$50.92	\$51.58	\$52.24	-	See Web

Standard Flexible Cable Assemblies

PE-B100 Coax, 50 Ohm						
Part No. PE34465	Cable Dia.			Attn. @ 1 GHz	Power @ 1 GHz	
1 piece price shown. See web or call for volume pricing.	0.101" dia.			dB/100ft	W	86
12"	24"	36"	48"	60"	72"	Custom Len.
\$60.37	\$67.45	\$74.55	\$81.64	\$88.74	\$95.83	See Web

RG58C/U Coax, 50 Ohm						
Part No. PE33654	Cable Dia.			Attn. @ 1 GHz	Power @ 1 GHz	
1 piece price shown. See web or call for volume pricing.	0.195" dia.			20 dB/100ft	44 W	87
12"	24"	36"	48"	60"	72"	Custom Len.
\$68.77	\$64.41	\$65.15	\$65.88	\$66.62	\$72.92	See Web

RG142B/U Coax, 50 Ohm						
Part No. PE33656	Cable Dia.			Attn. @ 1 GHz	Power @ 1 GHz	
1 piece price shown. See web or call for volume pricing.	0.195" dia.			13 dB/100ft	650 W	88
12"	24"	36"	48"	60"	72"	Custom Len.
\$67.89	\$73.61	\$84.12	\$85.08	\$90.82	\$102.94	See Web

RG174A/U Coax, 50 Ohm						
Part No. PE3916	Cable Dia.			Attn. @ 1 GHz	Power @ 1 GHz	
1 piece price shown. See web or call for volume pricing.	0.100" dia.			32 dB/100ft	16 W	89
12"	24"	36"	48"	60"	72"	Custom Len.
\$63.52	\$64.11	\$59.68	\$60.12	\$60.54	\$60.99	See Web

RG178B/U Coax, 50 Ohm						
Part No. PE33350	Cable Dia.			Attn. @ 1 GHz	Power @ 1 GHz	
1 piece price shown. See web or call for volume pricing.	0.072" dia.			44 dB/100ft	78 W	90
12"	24"	36"	48"	60"	72"	Custom Len.
\$65.69	\$66.64	\$67.61	\$68.56	\$69.52	\$70.49	See Web

RG188A/U Coax, 50 Ohm						
Part No. PE3589	Cable Dia.			Attn. @ 1 GHz	Power @ 1 GHz	
1 piece price shown. See web or call for volume pricing.	0.110" dia.			26 dB/100ft	160 W	91
12"	24"	36"	48"	60"	72"	Custom Len.
\$60.70	\$69.26	\$65.13	\$67.36	\$69.57	\$71.79	See Web

RG196A/U Coax, 50 Ohm						
Part No. PE3590	Cable Dia.			Attn. @ 1 GHz	Power @ 1 GHz	
1 piece price shown. See web or call for volume pricing.	0.080" dia.			49 dB/100ft	78 W	92
12"	24"	36"	48"	60"	72"	Custom Len.
\$61.19	\$62.51	\$63.83	\$65.13	\$66.45	\$67.77	See Web

RG223/U Coax, 50 Ohm						
Part No. PE33121	Cable Dia.			Attn. @ 1 GHz	Power @ 1 GHz	
1 piece price shown. See web or call for volume pricing.	0.209" dia.			13 dB/100ft	50 W	93
12"	24"	36"	48"	60"	72"	Custom Len.
\$65.03	\$67.93	\$70.83	\$73.74	\$76.64	\$79.53	See Web

RG316/U Coax, 50 Ohm						
Part No. PE3917	Cable Dia.			Attn. @ 1 GHz	Power @ 1 GHz	
1 piece price shown. See web or call for volume pricing.	0.098" dia.			38 dB/100ft	160 W	94
12"	24"	36"	48"	60"	72"	Custom Len.
\$62.75	\$70.89	\$68.52	\$77.32	\$74.30	\$83.69	See Web

RG316-DS Coax, 50 Ohm						
Part No. PE33476	Cable Dia.			Attn. @ 1 GHz	Power @ 1 GHz	
1 piece price shown. See web or call for volume pricing.	0.114" dia.			26 dB/100ft	160 W	95
12"	24"	36"	48"	60"	72"	Custom Len.
\$66.48	\$69.60	\$67.37	\$70.28	\$73.19	\$76.11	See Web

RG400/U Coax, 50 Ohm						
Part No. PE34461	Cable Dia.			Attn. @ 1 GHz	Power @ 1 GHz	
1 piece price shown. See web or call for volume pricing.	0.195" dia.			15 dB/100ft	650 W	96
12"	24"	36"	48"	60"	72"	Custom Len.
\$74.51	\$77.32	\$84.35	\$91.37	\$98.38	\$105.41	See Web

SMB PLUG RIGHT ANGLE TO SMB JACK BULKHEAD

SEE MOUNTING HOLE SECTION ON PAGE 369



Standard Flexible Cable Assemblies

PE-B100 Coax, 50 Ohm						
Part No. PE34479	Cable Dia.			Attn. @ 1 GHz	Power @ 1 GHz	
1 piece price shown. See web or call for volume pricing.	0.101" dia.			dB/100ft	W	97
12"	24"	36"	48"	60"	72"	Custom Len.
\$54.64	\$61.49	\$68.39	\$75.22	\$82.12	\$88.97	See Web

RG174A/U Coax, 50 Ohm						
Part No. PE33261	Cable Dia.			Attn. @ 1 GHz	Power @ 1 GHz	
1 piece price shown. See web or call for volume pricing.	0.100" dia.			32 dB/100ft	16 W	98
12"	24"	36"	48"	60"	72"	Custom Len.
\$59.64	\$60.07	\$60.51	\$60.95	\$61.38	\$61.81	See Web

RG178B/U Coax, 50 Ohm						
Part No. PE34467	Cable Dia.			Attn. @ 1 GHz	Power @ 1 GHz	
1 piece price shown. See web or call for volume pricing.	0.072" dia.			44 dB/100ft	78 W	99
12"	24"	36"	48"	60"	72"	Custom Len.
\$62.87	\$58.12	\$59.08	\$60.03	\$60.99	\$61.96	See Web

RG188A/U Coax, 50 Ohm						
-----------------------	--	--	--	--	--	--

*Coax Performance at 1 GHz Notes: Cable assembly max frequency may be lower than connector or coax max frequency

For our complete selection of cable assemblies, please visit our website

Part No. PE3594	Cable Dia.	Attn. @ 1 GHz	Power @ 1 GHz
1 piece price shown. See web or call for volume pricing.	0.110" dia.	26 dB/100ft	160 W
12" 24" 36" 48"	60" 72"	Custom Len.	
\$60.37 \$62.58 \$64.80 \$67.02	\$69.24	\$71.46	See Web

RG188-DS Coax, 50 Ohm

Part No. PE34477	Cable Dia.	Attn. @ 1 GHz	Power @ 1 GHz
1 piece price shown. See web or call for volume pricing.	0.122" dia.	30 dB/100ft	160 W
12" 24" 36" 48"	60" 72"	Custom Len.	
\$62.75 \$60.35 \$63.64 \$66.94	\$70.24	\$73.49	See Web

RG196A/U Coax, 50 Ohm

Part No. PE33682	Cable Dia.	Attn. @ 1 GHz	Power @ 1 GHz
1 piece price shown. See web or call for volume pricing.	0.080" dia.	49 dB/100ft	78 W
12" 24" 36" 48"	60" 72"	Custom Len.	
\$57.52 \$58.84 \$60.16 \$61.49	\$62.80	\$64.12	See Web

RG316/U Coax, 50 Ohm

Part No. PE33675	Cable Dia.	Attn. @ 1 GHz	Power @ 1 GHz
1 piece price shown. See web or call for volume pricing.	0.098" dia.	38 dB/100ft	160 W
12" 24" 36" 48"	60" 72"	Custom Len.	
\$56.79 \$59.79 \$62.80 \$65.80	\$68.79	\$78.40	See Web

RG316-DS Coax, 50 Ohm

Part No. PE33349	Cable Dia.	Attn. @ 1 GHz	Power @ 1 GHz
1 piece price shown. See web or call for volume pricing.	0.114" dia.	26 dB/100ft	160 W
12" 24" 36" 48"	60" 72"	Custom Len.	
\$56.68 \$65.47 \$62.56 \$65.51	\$68.44	\$71.32	See Web

SMB PLUG RIGHT ANGLE TO SSMB PLUG



Standard Flexible Cable Assemblies

RG174A/U Coax, 50 Ohm

Part No. PE3W04513	Cable Dia.	Attn. @ 1 GHz	Power @ 1 GHz
1 piece price shown. See web or call for volume pricing.	0.110" dia.	32 dB/100ft	17 W
12" 24" 36" 48"	60" 72"	Custom Len.	
\$56.70 \$57.26 \$57.82 \$58.38	\$58.94	\$56.49	See Web

SMC PLUG TO 10-32 MALE RIGHT ANGLE



Standard Flexible Cable Assemblies

RG196A/U Coax, 50 Ohm

Part No. PE3W00597	Cable Dia.	Attn. @ 1 GHz	Power @ 1 GHz
1 piece price shown. See web or call for volume pricing.	0.080" dia.	49 dB/100ft	78 W
12" 24" 36" 48"	60" 72"	Custom Len.	
\$71.85 \$73.22 \$74.58 \$75.94	\$77.30	\$72.73	See Web

SMC PLUG TO BNC MALE



Standard Flexible Cable Assemblies

RG58C/U Coax, 50 Ohm

Part No. PE3244	Cable Dia.	Attn. @ 1 GHz	Power @ 1 GHz
1 piece price shown. See web or call for volume pricing.	0.195" dia.	20 dB/100ft	44 W
12" 24" 36" 48"	60" 72"	Custom Len.	
\$50.35 \$51.09 \$54.99 \$52.55	\$56.69	\$54.03	See Web

RG174A/U Coax, 50 Ohm

Part No. PE3C3425	Cable Dia.	Attn. @ 1 GHz	Power @ 1 GHz
1 piece price shown. See web or call for volume pricing.	0.110" dia.	32 dB/100ft	17 W
12" 24" 36" 48"	60" 72"	Custom Len.	
\$43.40 \$43.98 \$44.56 \$41.50	\$45.76	\$42.37	See Web

RG188A/U Coax, 50 Ohm

Part No. PE3C2578	Cable Dia.	Attn. @ 1 GHz	Power @ 1 GHz
1 piece price shown. See web or call for volume pricing.	0.110" dia.	26 dB/100ft	160 W
12" 24" 36" 48"	60" 72"	Custom Len.	
\$41.17 \$43.39 \$45.60 \$47.83	\$53.80	\$52.26	See Web

RG223/U Coax, 50 Ohm

Part No. PE3238	Cable Dia.	Attn. @ 1 GHz	Power @ 1 GHz
1 piece price shown. See web or call for volume pricing.	0.209" dia.	13 dB/100ft	50 W
12" 24" 36" 48"	60" 72"	Custom Len.	
\$45.65 \$48.55 \$51.45 \$54.35	\$57.25	\$60.15	See Web

RG316/U Coax, 50 Ohm

Part No. PE3C2599	Cable Dia.	Attn. @ 1 GHz	Power @ 1 GHz
1 piece price shown. See web or call for volume pricing.	0.102" dia.	38 dB/100ft	160 W
12" 24" 36" 48"	60" 72"	Custom Len.	
\$42.73 \$45.85 \$48.98 \$52.28	\$51.25	\$54.13	See Web

SMC PLUG TO MCX PLUG



Low Loss Flexible Cable Assemblies

LMR-100A-PVC Coax, 50 Ohm

Part No. PE3W04152	Cable Dia.	Attn. @ 1 GHz	Power @ 1 GHz
1 piece price shown. See web or call for volume pricing.	0.110" dia.	24 dB/100ft	W
12" 24" 36" 48"	60" 72"	Custom Len.	
\$34.27 \$35.00 \$35.74 \$36.48	\$37.22	Call	See Web

SMC PLUG TO SMA MALE



Low Loss Flexible Cable Assemblies

LMR-100A-PVC Coax, 50 Ohm

Part No. PE3W04200	Cable Dia.	Attn. @ 1 GHz	Power @ 1 GHz
1 piece price shown. See web or call for volume pricing.	0.110" dia.	24 dB/100ft	W
12" 24" 36" 48"	60" 72"	Custom Len.	
\$39.68 \$40.42 \$41.15 \$41.89	\$42.63	\$40.16	See Web

SMC PLUG TO SMC PLUG



Standard Flexible Cable Assemblies

PE-B100 Coax, 50 Ohm

Part No. PE34501	Cable Dia.	Attn. @ 1 GHz	Power @ 1 GHz
1 piece price shown. See web or call for volume pricing.	0.101" dia.	dB/100ft	W
12" 24" 36" 48"	60" 72"	Custom Len.	
\$48.27 \$55.12 \$62.01 \$68.86	\$75.75	\$82.60	See Web

RG58C/U Coax, 50 Ohm

Part No. PE33641	Cable Dia.	Attn. @ 1 GHz	Power @ 1 GHz
1 piece price shown. See web or call for volume pricing.	0.195" dia.	20 dB/100ft	44 W
12" 24" 36" 48"	60" 72"	Custom Len.	
\$63.15 \$63.88 \$64.66 \$65.37	\$66.10	\$66.82	See Web

RG174A/U Coax, 50 Ohm

Part No. PE3883	Cable Dia.	Attn. @ 1 GHz	Power @ 1 GHz
1 piece price shown. See web or call for volume pricing.	0.100" dia.	32 dB/100ft	16 W
12" 24" 36" 48"	60" 72"	Custom Len.	
\$46.04 \$50.30 \$50.88 \$47.35	\$47.78	\$48.22	See Web

RG178B/U Coax, 50 Ohm

Part No. PE3902	Cable Dia.	Attn. @ 1 GHz	Power @ 1 GHz
1 piece price shown. See web or call for volume pricing.	0.072" dia.	44 dB/100ft	78 W
12" 24" 36" 48"	60" 72"	Custom Len.	
\$55.64 \$56.60 \$57.56 \$63.33	\$59.47	\$60.44	See Web

RG188A/U Coax, 50 Ohm

Part No. PE3595	Cable Dia.	Attn. @ 1 GHz	Power @ 1 GHz
1 piece price shown. See web or call for volume pricing.	0.110" dia.	26 dB/100ft	160 W
12" 24" 36" 48"	60" 72"	Custom Len.	
\$49.84 \$49.23 \$51.45 \$53.67	\$55.89	\$58.11	See Web

RG188-DS Coax, 50 Ohm

Part No. PE33154	Cable Dia.	Attn. @ 1 GHz	Power @ 1 GHz
1 piece price shown. See web or call for volume pricing.	0.118" dia.	30 dB/100ft	160 W
12" 24" 36" 48"	60" 72"	Custom Len.	
\$44.68 \$47.98 \$51.27 \$54.58	\$57.87	\$61.12	See Web

RG223/U Coax, 50 Ohm

Part No. PE33647	Cable Dia.	Attn. @ 1 GHz	Power @ 1 GHz
1 piece price shown. See web or call for volume pricing.	0.210" dia.	13 dB/100ft	53 W
12" 24" 36" 48"	60" 72"	Custom Len.	
\$61.24 \$64.13 \$67.04 \$69.94	\$72.83	\$75.73	See Web

RG316/U Coax, 50 Ohm

Part No. PE3808	Cable Dia.	Attn. @ 1 GHz	Power @ 1 GHz
1 piece price shown. See web or call for volume pricing.	0.098" dia.	38 dB/100ft	160 W
12" 24" 36" 48"	60" 72"	Custom Len.	
\$53.78 \$56.90 \$60.02 \$63.33	\$60.44	\$63.33	See Web

RG316-DS Coax, 50 Ohm

Part No. PE34721	Cable Dia.	Attn. @ 1 GHz	Power @ 1 GHz
1 piece price shown. See web or call for volume pricing.	0.114" dia.	26 dB/100ft	160 W
12" 24" 36" 48"	60" 72"	Custom Len.	
\$48.76 \$51.67 \$54.57 \$57.48	\$60.40	\$67.62	See Web

SMC PLUG TO SMC PLUG RIGHT ANGLE



Standard Flexible Cable Assemblies

RG174A/U Coax, 50 Ohm

Part No. PE33556	Cable Dia.	Attn. @ 1 GHz	Power @ 1 GHz
1 piece price shown. See web or call for volume pricing.	0.100" dia.	32 dB/100ft	16 W
12" 24" 36" 48"	60" 72"	Custom Len.	
\$57.66 \$58.24 \$53.31 \$53.74	\$54.22	\$54.64	See Web

RG178B/U Coax, 50 Ohm

Part No. PE34492	Cable Dia.	Attn. @ 1 GHz	Power @ 1 GHz
1 piece price shown. See web or call for volume pricing.	0.072" dia.	44 dB/100ft	78 W
12" 24" 36" 48"	60" 72"	Custom Len.	
\$61.17 \$67.12 \$63.08 \$64.04	\$65.00	\$65.96	See Web

RG188A/U Coax, 50 Ohm

Part No. PE3600	Cable Dia.	Attn. @ 1 GHz	Power @ 1 GHz
1 piece price shown. See web or call for volume pricing.	0.110" dia.	26 dB/100ft	160 W
12" 24" 36" 48"	60" 72"	Custom Len.	
\$58.42 \$60.65 \$69.25 \$65.08	\$67.31	\$69.52	See Web

Cable Assemblies

See Our Website For Current Pricing & Real-Time Stock Availability!

For Custom Lengths, Metric Lengths or Special Configurations, Please call (949) 261-1920

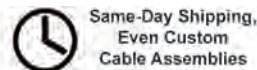
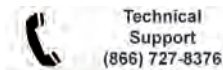

For our complete selection of cable assemblies, please visit our website

RG223/U Coax, 50 Ohm						
Part No. PE33664	Cable Dia.	Attn. @ 1 GHz	Power @ 1 GHz			
1 piece price shown. See web or call for volume pricing.						
12"	24"	36"	48"	60"	72"	Custom Len.
\$59.33	\$62.22	\$65.11	\$68.01	\$70.92	\$73.82	See Web
RG316/U Coax, 50 Ohm						
Part No. PE33363	Cable Dia.	Attn. @ 1 GHz	Power @ 1 GHz			
1 piece price shown. See web or call for volume pricing.						
12"	24"	36"	48"	60"	72"	Custom Len.
\$66.54	\$63.38	\$66.28	\$69.17	\$72.05	\$74.93	See Web
Standard Flexible Cable Assemblies						
RG58C/U Coax, 50 Ohm						
Part No. PE34503	Cable Dia.	Attn. @ 1 GHz	Power @ 1 GHz			
1 piece price shown. See web or call for volume pricing.						
12"	24"	36"	48"	60"	72"	Custom Len.
\$66.76	\$67.47	\$68.25	\$68.99	\$69.71	\$70.43	See Web
RG174A/U Coax, 50 Ohm						
Part No. PE33580	Cable Dia.	Attn. @ 1 GHz	Power @ 1 GHz			
1 piece price shown. See web or call for volume pricing.						
12"	24"	36"	48"	60"	72"	Custom Len.
\$48.51	\$48.95	\$49.38	\$49.82	\$50.25	\$50.68	See Web
RG178B/U Coax, 50 Ohm						
Part No. PE33352	Cable Dia.	Attn. @ 1 GHz	Power @ 1 GHz			
1 piece price shown. See web or call for volume pricing.						
12"	24"	36"	48"	60"	72"	Custom Len.
\$68.93	\$74.12	\$70.84	\$71.81	\$72.76	\$73.72	See Web
RG316/U Coax, 50 Ohm						
Part No. PE33690	Cable Dia.	Attn. @ 1 GHz	Power @ 1 GHz			
1 piece price shown. See web or call for volume pricing.						
12"	24"	36"	48"	60"	72"	Custom Len.
\$51.23	\$50.42	\$53.44	\$56.43	\$59.44	\$62.43	See Web
RG316-DS Coax, 50 Ohm						
Part No. PE34511	Cable Dia.	Attn. @ 1 GHz	Power @ 1 GHz			
1 piece price shown. See web or call for volume pricing.						
12"	24"	36"	48"	60"	72"	Custom Len.
\$51.18	\$59.42	\$57.00	\$65.85	\$62.82	\$65.73	See Web
Standard Flexible Cable Assemblies						
RG174A/U Coax, 50 Ohm						
Part No. PE3C1988	Cable Dia.	Attn. @ 1 GHz	Power @ 1 GHz			
1 piece price shown. See web or call for volume pricing.						
12"	24"	36"	48"	60"	50CM	Custom Len.
\$46.20	\$46.77	\$47.33	\$47.89	\$48.45	\$46.57	See Web
Standard Flexible Cable Assemblies						
RG58C/U Coax, 50 Ohm						
Part No. PE33643	Cable Dia.	Attn. @ 1 GHz	Power @ 1 GHz			
1 piece price shown. See web or call for volume pricing.						
12"	24"	36"	48"	60"	72"	Custom Len.
\$70.17	\$70.90	\$71.63	\$72.37	\$80.51	\$73.84	See Web
RG142B/U Coax, 50 Ohm						
Part No. PE33645	Cable Dia.	Attn. @ 1 GHz	Power @ 1 GHz			
1 piece price shown. See web or call for volume pricing.						
12"	24"	36"	48"	60"	72"	Custom Len.
\$62.85	\$68.39	\$73.96	\$79.48	\$85.00	\$90.60	See Web
RG174A/U Coax, 50 Ohm						
Part No. PE3918	Cable Dia.	Attn. @ 1 GHz	Power @ 1 GHz			
1 piece price shown. See web or call for volume pricing.						
12"	24"	36"	48"	60"	72"	Custom Len.
\$62.69	\$63.12	\$63.56	\$63.99	\$64.42	\$70.65	See Web
RG178B/U Coax, 50 Ohm						
Part No. PE3765	Cable Dia.	Attn. @ 1 GHz	Power @ 1 GHz			
1 piece price shown. See web or call for volume pricing.						
12"	24"	36"	48"	60"	72"	Custom Len.
\$64.99	\$66.05	\$62.09	\$63.06	\$64.02	\$64.98	See Web
RG188A/U Coax, 50 Ohm						
Part No. PE3597	Cable Dia.	Attn. @ 1 GHz	Power @ 1 GHz			
1 piece price shown. See web or call for volume pricing.						
12"	24"	36"	48"	60"	72"	Custom Len.
\$63.35	\$60.81	\$62.93	\$65.07	\$67.23	\$69.35	See Web
RG316/U Coax, 50 Ohm						

Part No. PE3919				Cable Dia.	Attn. @ 1 GHz	Power @ 1 GHz
1 piece price shown. See web or call for volume pricing.						
12"	24"	36"	48"	0.098" dia.	38 dB/100ft	160 W
\$65.53	\$68.41	\$71.30	\$74.18	\$77.07	\$79.96	See Web
RG400/U Coax, 50 Ohm						
Part No. PE34459				Cable Dia.	Attn. @ 1 GHz	Power @ 1 GHz
1 piece price shown. See web or call for volume pricing.						
12"	24"	36"	48"	0.195" dia.	15 dB/100ft	650 W
\$70.29	\$77.32	\$84.35	\$91.37	\$98.38	\$105.41	See Web
SMC PLUG RIGHT ANGLE TO SMC JACK BULKHEAD						
SEE MOUNTING HOLE SECTION ON PAGE 369						
Standard Flexible Cable Assemblies						
RG174A/U Coax, 50 Ohm						
Part No. PE34078				Cable Dia.	Attn. @ 1 GHz	Power @ 1 GHz
1 piece price shown. See web or call for volume pricing.						
12"	24"	36"	48"	0.100" dia.	32 dB/100ft	16 W
\$55.48	\$55.89	\$56.38	\$56.79	\$57.21	\$57.71	See Web
RG316/U Coax, 50 Ohm						
Part No. PE34472				Cable Dia.	Attn. @ 1 GHz	Power @ 1 GHz
1 piece price shown. See web or call for volume pricing.						
12"	24"	36"	48"	0.098" dia.	38 dB/100ft	160 W
\$58.00	\$60.99	\$64.00	\$67.01	\$70.01	\$73.01	See Web
SMC PLUG RIGHT ANGLE TO TNC FEMALE BULKHEAD						
SEE MOUNTING HOLE SECTION ON PAGE 369						
Standard Flexible Cable Assemblies						
RG178B/U Coax, 50 Ohm						
Part No. PE3W05426				Cable Dia.	Attn. @ 1 GHz	Power @ 1 GHz
1 piece price shown. See web or call for volume pricing.						
12"	24"	36"	48"	0.072" dia.	44 dB/100ft	55 W
\$57.87	\$58.99	\$60.13	\$61.26	\$62.39	\$58.59	See Web
SMP MALE BULKHEAD TO SMA MALE						
SEE MOUNTING HOLE SECTION ON PAGE 369						
Standard Formable Cable Assemblies						
PE-SR405FLJ Coax, 50 Ohm						
Part No. PE3W05498				Cable Dia.	Attn. @ 1 GHz	Power @ 1 GHz
1 piece price shown. See web or call for volume pricing.						
12"	24"	36"	48"	0.105" dia.	20 dB/100ft	122 W
\$75.36	\$84.30	\$93.26	\$102.22	\$111.17	\$81.09	See Web
SMP FEMALE TO SMA MALE						
Standard Formable Cable Assemblies						
PE-SR405FL Coax, 50 Ohm						
Part No. PE3W07044				Cable Dia.	Attn. @ 1 GHz	Power @ 1 GHz
1 piece price shown. See web or call for volume pricing.						
12"	24"	36"	48"	* dia.	23 dB/100ft	105 W
\$50.39	\$62.07	\$73.75	\$85.43	\$97.10	\$57.87	See Web
SMP FEMALE TO SMP FEMALE						
Standard Formable Cable Assemblies						
PE-SR047FL Coax, 50 Ohm						
Part No. PE36148				Cable Dia.	Attn. @ 1 GHz	Power @ 1 GHz
1 piece price shown. See web or call for volume pricing.						
12"	24"	36"	48"	0.047" dia.	36 dB/100ft	32 W
\$98.56	\$100.35	\$107.71	\$115.09	\$122.47	\$129.83	See Web
PE-SR405FL Coax, 50 Ohm						
Part No. PE36152				Cable Dia.	Attn. @ 1 GHz	Power @ 1 GHz
1 piece price shown. See web or call for volume pricing.						
12"	24"	36"	48"	* dia.	23 dB/100ft	130 W
\$75.21	\$86.56	\$91.66	\$102.04	\$112.43	\$122.82	See Web
PE-SR405FL Coax, 50 Ohm						
Part No. PE3C4341				Cable Dia.	Attn. @ 1 GHz	Power @ 1 GHz
1 piece price shown. See web or call for volume pricing.						
12"	24"	36"	48"	* dia.	23 dB/100ft	105 W
\$62.76	\$74.43	\$86.11	\$97.79	\$109.47	\$70.24	See Web
Standard Flexible Cable Assemblies						
PE-P047 Coax, 50 Ohm						
Part No. PE3C0757				Cable Dia.	Attn. @ 1 GHz	Power @ 1 GHz
1 piece price shown. See web or call for volume pricing.						
12"	24"	36"	48"	0.056" dia.	35 dB/100ft	43 W
\$64.40	\$72.17	\$79.94	\$87.71	\$95.48	\$69.37	See Web

Cable Assemblies

See Our Website For Current Pricing & Real-Time Stock Availability!

*Coax Performance at 1 GHz Notes: Cable assembly max frequency may be lower than connector or coax max frequency

For our complete selection of cable assemblies, please visit our website

Standard Semi-Rigid Cable Assemblies							
RG405/U Coax, 50 Ohm							
Part No.	PE36150				Cable Dia.	Attn. @ 1 GHz	Power @ 1 GHz
1 piece price shown. See web or call for volume pricing.							
12"	24"	36"	48"	60"	72"	Custom Len.	
\$106.51	\$113.94	\$80.51	\$120.42	\$93.82	\$100.48	See Web	

SMP FEMALE TO SMP FEMALE RIGHT ANGLE



Standard Formable Cable Assemblies							
PE-SR405FL Coax, 50 Ohm							
Part No.	PE36160				Cable Dia.	Attn. @ 1 GHz	Power @ 1 GHz
1 piece price shown. See web or call for volume pricing.							
12"	24"	36"	48"	60"	72"	Custom Len.	
\$86.74	\$97.43	\$114.62	\$118.81	\$129.51	\$140.20	See Web	

Standard Semi-Rigid Cable Assemblies							
PE-SR405FLJ Coax, 50 Ohm							
Part No.	PE3C0438				Cable Dia.	Attn. @ 1 GHz	Power @ 1 GHz
1 piece price shown. See web or call for volume pricing.							
6"	9"	12"	18"	24"	-	Custom Len.	
\$80.84	\$83.62	\$85.70	\$84.72	\$94.24	-	See Web	

Standard Semi-Rigid Cable Assemblies							
RG405/U Coax, 50 Ohm							
Part No.	PE36158				Cable Dia.	Attn. @ 1 GHz	Power @ 1 GHz
1 piece price shown. See web or call for volume pricing.							
12"	24"	36"	48"	60"	72"	Custom Len.	
\$82.79	\$89.66	\$96.52	\$103.40	\$110.26	\$117.14	See Web	

SMP FEMALE RIGHT ANGLE TO MMCX PLUG RIGHT ANGLE



Standard Formable Cable Assemblies							
PE-SR405FLJ Coax, 50 Ohm							
Part No.	PE3C3221				Cable Dia.	Attn. @ 1 GHz	Power @ 1 GHz
1 piece price shown. See web or call for volume pricing.							
12"	24"	36"	48"	60"	39.37"	Custom Len.	
\$67.69	\$75.98	\$84.27	\$92.56	\$100.86	Call	See Web	

SMP FEMALE RIGHT ANGLE TO N FEMALE BULKHEAD
SEE MOUNTING HOLE SECTION ON PAGE 369



Flexible Cable Assemblies							
LMR-100A-PVC Coax, 50 Ohm							
Part No.	PE3W05673				Cable Dia.	Attn. @ 1 GHz	Power @ 1 GHz
1 piece price shown. See web or call for volume pricing.							
12"	24"	36"	48"	60"	50CM	Custom Len.	
\$53.44	\$54.15	\$54.88	\$55.61	\$56.33	\$53.89	See Web	

SMP FEMALE RIGHT ANGLE TO SMA MALE RIGHT ANGLE



Standard Flexible Cable Assemblies							
RG316/U Coax, 50 Ohm							
Part No.	PE3W05056				Cable Dia.	Attn. @ 1 GHz	Power @ 1 GHz
1 piece price shown. See web or call for volume pricing.							
12"	24"	36"	48"	60"	50CM	Custom Len.	
\$57.35	\$60.63	\$63.91	\$67.19	\$70.48	\$59.45	See Web	

SMP FEMALE RIGHT ANGLE TO SMA FEMALE



Standard Formable Cable Assemblies							
PE-SR405FL Coax, 50 Ohm							
Part No.	PE3W05740				Cable Dia.	Attn. @ 1 GHz	Power @ 1 GHz
1 piece price shown. See web or call for volume pricing.							
12"	24"	36"	48"	60"	50CM	Custom Len.	
\$70.10	\$81.78	\$93.46	\$105.14	\$116.81	\$77.58	See Web	

SMP FEMALE RIGHT ANGLE TO SMP FEMALE



Standard Formable Cable Assemblies							
PE-SR405FL Coax, 50 Ohm							
Part No.	PE3W03777				Cable Dia.	Attn. @ 1 GHz	Power @ 1 GHz
1 piece price shown. See web or call for volume pricing.							
12"	24"	36"	48"	60"	50CM	Custom Len.	
\$76.49	\$88.17	\$99.85	\$111.53	\$123.20	\$83.97	See Web	

Standard Flexible Cable Assemblies							
PE-P047 Coax, 50 Ohm							
Part No.	PE3C4969				Cable Dia.	Attn. @ 1 GHz	Power @ 1 GHz
1 piece price shown. See web or call for volume pricing.							
12"	24"	36"	48"	60"	39.37"	Custom Len.	
\$98.81	\$106.57	\$114.34	\$122.11	\$129.89	Call	See Web	

SMP FEMALE RIGHT ANGLE TO SMP FEMALE RIGHT ANGLE



Standard Semi-Rigid Cable Assemblies							
PE-047SR Coax, 50 Ohm							
Part No.	PE3W04802				Cable Dia.	Attn. @ 1 GHz	Power @ 1 GHz
1 piece price shown. See web or call for volume pricing.							
12"	24"	36"	48"	60"	50CM	Custom Len.	
\$57.71	\$68.45	\$79.19	\$89.94	\$100.68	\$64.58	See Web	

Standard Flexible Cable Assemblies							
LMR-100A-PVC Coax, 50 Ohm							
Part No.	PE3W05481				Cable Dia.	Attn. @ 1 GHz	Power @ 1 GHz
1 piece price shown. See web or call for volume pricing.							
12"	24"	36"	48"	60"	50CM	Custom Len.	
\$82.93	\$83.65	\$84.38	\$85.10	\$85.83	\$83.39	See Web	

Standard Flexible Cable Assemblies							
LMR-100A-PVC Coax, 50 Ohm							
Part No.	PE3W05481				Cable Dia.	Attn. @ 1 GHz	Power @ 1 GHz
1 piece price shown. See web or call for volume pricing.							
12"	24"	36"	48"	60"	50CM	Custom Len.	
\$82.93	\$83.65	\$84.38	\$85.10	\$85.83	\$83.39	See Web	

Standard Flexible Cable Assemblies							
RG174A/U Coax, 50 Ohm							
Part No.	PE3673				Cable Dia.	Attn. @ 1 GHz	Power @ 1 GHz
1 piece price shown. See web or call for volume pricing.							
6"	12"	18"	24"	36"	48"	Custom Len.	
\$64.12	\$64.29	\$64.54	\$64.78	\$65.21	\$65.68	See Web	

Standard Flexible Cable Assemblies							
RG178B/U Coax, 50 Ohm							
Part No.	PE33762				Cable Dia.	Attn. @ 1 GHz	Power @ 1 GHz
1 piece price shown. See web or call for volume pricing.							
6"	12"	18"	24"	36"	48"	Custom Len.	
\$73.44	\$73.44	\$73.92	\$78.90	\$75.37	\$81.08	See Web	

Standard Flexible Cable Assemblies							
RG316/U Coax, 50 Ohm							
Part No.	PE33071				Cable Dia.	Attn. @ 1 GHz	Power @ 1 GHz
1 piece price shown. See web or call for volume pricing.							
6"	12"	18"	24"	36"	48"	Custom Len.	
\$72.23	\$72.23	\$73.67	\$75.11	\$78.00	\$80.89	See Web	

Standard Flexible Cable Assemblies							
RG174A/U Coax, 50 Ohm							
Part No.	PE36569				Cable Dia.	Attn. @ 1 GHz	Power @ 1 GHz
1 piece price shown. See web or call for volume pricing.							
6"	12"	18"	24"	36"	48"	Custom Len.	
\$67.77	\$74.82	\$68.25	\$68.44	\$68.92	\$69.35	See Web	

Standard Flexible Cable Assemblies							
RG316/U Coax, 50 Ohm							
Part No.	PE36573				Cable Dia.	Attn. @ 1 GHz	Power @ 1 GHz
1 piece price shown. See web or call for volume pricing.							
6"	12"	18"	24"	36"	48"	Custom Len.	
\$73.25	\$70.54	\$72.03	\$73.54	\$76.54	\$79.54	See Web	

Standard Flexible Cable Assemblies							
RG178B/U Coax, 50 Ohm							
Part No.	PE36572				Cable Dia.	Attn. @ 1 GHz	Power @ 1 GHz
1 piece price shown. See web or call for volume pricing.							
6"	12"	18"	24"	36"	48"	Custom Len.	
\$123.65	\$124.13	\$124.63	\$125.10	\$126.04	\$127.02	See Web	

Standard Flexible Cable Assemblies							
RG316/U Coax, 50 Ohm							
Part No.	PE36574				Cable Dia.	Attn. @ 1 GHz	Power @ 1 GHz
1 piece price shown. See web or call for volume pricing.							
6"	12"	18"	24"	36"	48"	Custom Len.	
\$72.77	\$74.27	\$75.75	\$77.26	\$80.26	\$83.26	See Web	

Standard Flexible Cable Assemblies							
RG316-DS Coax, 50 Ohm							
Part No.	PE38407				Cable Dia.	Attn. @ 1 GHz	Power @ 1 GHz
1 piece price shown. See web or call for volume pricing.							
12"	24"	36"	48"	60"	-	Custom Len.	
\$69.35	\$72.10	\$74.81	\$77.50	\$80.26	-	See Web	

Cable Assemblies

See Our Website For Current Pricing & Real-Time Stock Availability!

For Custom Lengths, Metric Lengths or Special Configurations, Please call (949) 261-1920

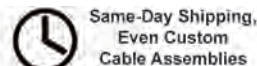
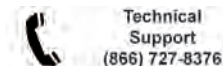

SSMB PLUG TO SMA MALE



Standard Flexible Cable Assemblies

RG188-DS Coax, 50 Ohm

Part No. PE3W06018	Cable Dia.	Attn. @ 1 GHz	Power @ 1 GHz
1 piece price shown. See web or call for volume pricing.			
12"	0.118" dia.	30 dB/100ft	160 W
24"	60"	50CM	Custom Len.
\$50.99	\$54.69	\$58.39	\$62.09
\$65.79	\$53.36	See Web	

71

Part No. PE3W06717	Cable Dia.	Attn. @ 1 GHz	Power @ 1 GHz
1 piece price shown. See web or call for volume pricing.			
12"	0.118" dia.	30 dB/100ft	160 W
24"	60"	50CM	Custom Len.
\$79.12	\$82.82	\$86.52	\$90.22
\$93.82	\$81.49	See Web	

72

SSMB PLUG TO SSMB PLUG



Standard Flexible Cable Assemblies

RG188-DS Coax, 50 Ohm

Part No. PE3W06017	Cable Dia.	Attn. @ 1 GHz	Power @ 1 GHz
1 piece price shown. See web or call for volume pricing.			
12"	0.118" dia.	30 dB/100ft	160 W
24"	60"	50CM	Custom Len.
\$72.49	\$76.19	\$79.89	\$83.59
\$87.29	\$74.86	See Web	

73

RG196A/U Coax, 50 Ohm

Part No. PE3122	Cable Dia.	Attn. @ 1 GHz	Power @ 1 GHz
1 piece price shown. See web or call for volume pricing.			
12"	0.080" dia.	49 dB/100ft	78 W
24"	60"	72"	Custom Len.
\$76.08	\$83.58	\$78.81	\$80.19
\$81.56	\$82.92	See Web	

74

RG316/U Coax, 50 Ohm

Part No. PE3139	Cable Dia.	Attn. @ 1 GHz	Power @ 1 GHz
1 piece price shown. See web or call for volume pricing.			
12"	0.102" dia.	38 dB/100ft	W
24"	60"	72"	Custom Len.
\$87.76	\$90.88	\$87.04	\$89.93
\$92.81	\$95.70	See Web	

75

SSMB PLUG RIGHT ANGLE TO SSMB PLUG RIGHT ANGLE



Standard Flexible Cable Assemblies

RG178B/U Coax, 50 Ohm

Part No. PE3C4801	Cable Dia.	Attn. @ 1 GHz	Power @ 1 GHz
1 piece price shown. See web or call for volume pricing.			
12"	0.072" dia.	44 dB/100ft	55 W
24"	60"	50CM	Custom Len.
\$53.53	\$54.56	\$55.59	\$56.62
\$57.64	\$54.18	See Web	

76

RG196A/U Coax, 50 Ohm

Part No. PE3134	Cable Dia.	Attn. @ 1 GHz	Power @ 1 GHz
1 piece price shown. See web or call for volume pricing.			
12"	0.080" dia.	49 dB/100ft	78 W
24"	60"	72"	Custom Len.
\$64.92	\$66.30	\$67.66	\$69.03
\$70.41	\$71.77	See Web	

77

RG316/U Coax, 50 Ohm

Part No. PE3157	Cable Dia.	Attn. @ 1 GHz	Power @ 1 GHz
1 piece price shown. See web or call for volume pricing.			
12"	0.102" dia.	38 dB/100ft	W
24"	60"	72"	Custom Len.
\$85.28	\$88.40	\$86.23	\$89.10
\$98.02	\$94.89	See Web	

78

SSMC PLUG TO SMB JACK BULKHEAD



SEE MOUNTING HOLE SECTION ON PAGE 369

Standard Flexible Cable Assemblies

RG178B/U Coax, 50 Ohm

Part No. PE3W08023	Cable Dia.	Attn. @ 1 GHz	Power @ 1 GHz
1 piece price shown. See web or call for volume pricing.			
12"	0.072" dia.	44 dB/100ft	55 W
24"	60"	50CM	Custom Len.
\$61.40	\$61.94	\$62.49	\$63.58
\$64.67	\$65.76	See Web	

79

SSMC PLUG TO SSMB PLUG



Low Loss Flexible Cable Assemblies

LMR-100A-PVC Coax, 50 Ohm

Part No. PE3C4419	Cable Dia.	Attn. @ 1 GHz	Power @ 1 GHz
1 piece price shown. See web or call for volume pricing.			
6"	0.110" dia.	24 dB/100ft	W
12"	36"	48"	Custom Len.
\$64.85	\$71.76	\$65.60	\$65.97
\$66.70	\$67.44	See Web	

80

Standard Formable Cable Assemblies

PE-SR405FLJ Coax, 50 Ohm

Part No. PE3C4441	Cable Dia.	Attn. @ 1 GHz	Power @ 1 GHz
1 piece price shown. See web or call for volume pricing.			
6"	0.105" dia.	20 dB/100ft	122 W
18"	24"	48"	Custom Len.
\$71.64	\$79.18	\$90.46	\$75.41
\$82.93	\$97.99	See Web	

81

Standard Flexible Cable Assemblies

RG178B/U Coax, 50 Ohm

Part No. PE3C4388	Cable Dia.	Attn. @ 1 GHz	Power @ 1 GHz
1 piece price shown. See web or call for volume pricing.			
72"	0.072" dia.	44 dB/100ft	55 W
6"	12"	18"	24"
\$79.47	\$78.80	\$74.82	\$79.84
\$74.82	\$75.74	\$76.68	Custom Len.
See Web			

82

RG316/U Coax, 50 Ohm

Part No. PE3C4403	Cable Dia.	Attn. @ 1 GHz	Power @ 1 GHz
1 piece price shown. See web or call for volume pricing.			
6"	0.098" dia.	58 dB/100ft	160 W
12"	18"	24"	36"
\$70.67	\$72.08	\$73.49	\$74.87
\$77.69	\$80.48	Custom Len.	
See Web			

83

SSMC PLUG TO SSMB PLUG RIGHT ANGLE



Low Loss Flexible Cable Assemblies

LMR-100A-PVC Coax, 50 Ohm

Part No. PE3C4420	Cable Dia.	Attn. @ 1 GHz	Power @ 1 GHz
1 piece price shown. See web or call for volume pricing.			
6"	0.110" dia.	24 dB/100ft	W
12"	18"	24"	36"
\$61.43	\$61.80	\$62.17	\$62.54
\$63.28	\$64.01	Custom Len.	
See Web			

84

Standard Flexible Cable Assemblies

RG178B/U Coax, 50 Ohm

Part No. PE3C4455	Cable Dia.	Attn. @ 1 GHz	Power @ 1 GHz
1 piece price shown. See web or call for volume pricing.			
6"	0.072" dia.	44 dB/100ft	55 W
12"	18"	24"	36"
\$65.92	\$66.40	\$66.87	\$67.34
\$68.26	\$69.20	Custom Len.	
See Web			

85

RG316/U Coax, 50 Ohm

Part No. PE3C4404	Cable Dia.	Attn. @ 1 GHz	Power @ 1 GHz
1 piece price shown. See web or call for volume pricing.			
6"	0.098" dia.	58 dB/100ft	160 W
12"	18"	24"	36"
\$67.23	\$68.65	\$70.05	\$71.44
\$74.26	\$77.04	Custom Len.	
See Web			

86

SSMC PLUG TO SSMB JACK BULKHEAD



SEE MOUNTING HOLE SECTION ON PAGE 369

Standard Formable Cable Assemblies

PE-SR405FLJ Coax, 50 Ohm

Part No. PE3C4442	Cable Dia.	Attn. @ 1 GHz	Power @ 1 GHz
1 piece price shown. See web or call for volume pricing.			
6"	0.105" dia.	20 dB/100ft	122 W
12"	18"	24"	36"
\$71.31	\$68.59	\$72.36	\$76.12
\$83.64	\$87.92	Custom Len.	
See Web			

87

Standard Flexible Cable Assemblies

RG178B/U Coax, 50 Ohm

Part No. PE3C4389	Cable Dia.	Attn. @ 1 GHz	Power @ 1 GHz
1 piece price shown. See web or call for volume pricing.			
6"	0.072" dia.	44 dB/100ft	55 W
12"	18"	24"	36"
\$70.36	\$70.84	\$71.31	\$71.77
\$72.71	\$81.17	Custom Len.	
See Web			

88

SSMC PLUG RIGHT ANGLE TO SMA MALE



Standard Flexible Cable Assemblies

RG188-DS Coax, 50 Ohm

Part No. PE3W04994	Cable Dia.	Attn. @ 1 GHz	Power @ 1 GHz
1 piece price shown. See web or call for volume pricing.			
12"	0.118" dia.	30 dB/100ft	160 W
24"	60"	50CM	Custom Len.
\$58.46	\$62.15	\$65.85	\$69.55
\$73.25	\$60.83	See Web	

89

SSMC PLUG RIGHT ANGLE TO SSMB PLUG RIGHT ANGLE



Standard Flexible Cable Assemblies

RG316/U Coax, 50 Ohm

Part No. PE3C4374	Cable Dia.	Attn. @ 1 GHz	Power @ 1 GHz
1 piece price shown. See web or call for volume pricing.			
6"	0.098" dia.	58 dB/100ft	160 W
12"	18"	24"	36"
\$63.80	\$65.21	\$66.62	\$68.00
\$70.82	\$73.61	Custom Len.	
See Web			

90

RG316-DS Coax, 50 Ohm

Part No. PE3C4470	Cable Dia.	Attn. @ 1 GHz	Power @ 1 GHz
1 piece price shown. See web or call for volume pricing.			
6"	0.114" dia.	9 dB/100ft	85 W
12"	18"	24"	36"
\$66.94	\$64.58	\$66.01	\$67.41
\$70.24	\$73.06	Custom Len.	
See Web			

91

SSMC PLUG RIGHT ANGLE TO SSMB JACK BULKHEAD



SEE MOUNTING HOLE SECTION ON PAGE 369





Standard Flexible Cable Assemblies

RG178B/U Coax, 50 Ohm

Cable Assemblies

See Our Website For Current Pricing & Real-Time Stock Availability!

For our complete selection of cable assemblies, please visit our website

Part No. PE3C4458					Cable Dia.	Attn. @ 1 GHz	Power @ 1 GHz	92
1 piece price shown. See web or call for volume pricing.					0.072" dia.	44 dB/100ft	55 W	
6"	12"	18"	24"	36"	48"	Custom Len.		
\$61.96	\$62.43	\$62.89	\$63.36	\$64.29	\$65.23	See Web		
 <p>SSMC PLUG RIGHT ANGLE TO TNC FEMALE BULKHEAD SEE MOUNTING HOLE SECTION ON PAGE 369</p>								
Standard Flexible Cable Assemblies								
RG178B/U Coax, 50 Ohm								
Part No. PE3W05518					Cable Dia.	Attn. @ 1 GHz	Power @ 1 GHz	93
1 piece price shown. See web or call for volume pricing.					0.072" dia.	dB/100ft	55 W	
12"	24"	36"	48"	60"	50CM	Custom Len.		
\$60.20	\$61.32	\$62.45	\$63.59	\$64.72	\$60.92	See Web		
 <p>SSMC JACK BULKHEAD TO SSMC JACK RIGHT ANGLE BULKHEAD SEE MOUNTING HOLE SECTION ON PAGE 369</p>								
Standard Flexible Cable Assemblies								
RG178B/U Coax, 50 Ohm								
Part No. PE3C4461					Cable Dia.	Attn. @ 1 GHz	Power @ 1 GHz	94
1 piece price shown. See web or call for volume pricing.					0.072" dia.	44 dB/100ft	55 W	
6"	12"	18"	24"	36"	48"	Custom Len.		
\$63.95	\$64.42	\$64.89	\$65.35	\$66.29	\$67.21	See Web		
 <p>SSMC JACK RIGHT ANGLE BULKHEAD TO SSMC JACK RIGHT ANGLE BULKHEAD SEE MOUNTING HOLE SECTION ON PAGE 369</p>								
Standard Flexible Cable Assemblies								
RG178B/U Coax, 50 Ohm								
Part No. PE3C4462					Cable Dia.	Attn. @ 1 GHz	Power @ 1 GHz	95
1 piece price shown. See web or call for volume pricing.					0.072" dia.	44 dB/100ft	55 W	
6"	12"	18"	24"	36"	48"	Custom Len.		
\$61.50	\$61.98	\$68.70	\$62.91	\$63.84	\$64.77	See Web		
 <p>TNC MALE TO TNC MALE</p>								
Standard Flexible Cable Assemblies								
M17/60-RG142-27478 Coax, 50 Ohm								
Part No. PE3M0028					Cable Dia.	Attn. @ 1 GHz	Power @ 1 GHz	96
1 piece price shown. See web or call for volume pricing.					0.195" dia.	dB/100ft	W	
12"	18"	24"	30"	36"	48"	Custom Len.		
\$157.19	\$159.91	\$162.65	\$165.37	\$168.10	\$173.55	See Web		
M17/84-RG223-0XDS2 Coax, 50 Ohm								
Part No. PE3M0056					Cable Dia.	Attn. @ 1 GHz	Power @ 1 GHz	97
1 piece price shown. See web or call for volume pricing.					0.212" dia.	dB/100ft	W	
12"	18"	24"	30"	36"	48"	Custom Len.		
\$161.49	\$166.36	\$171.25	\$176.12	\$181.00	\$190.76	See Web		
M17/128-RG400-27478 Coax, 50 Ohm								
Part No. PE3M0084					Cable Dia.	Attn. @ 1 GHz	Power @ 1 GHz	98
1 piece price shown. See web or call for volume pricing.					0.195" dia.	dB/100ft	W	
12"	18"	24"	30"	36"	48"	Custom Len.		
\$158.68	\$162.15	\$165.62	\$169.09	\$172.56	\$179.50	See Web		
M17/113-RG316-27478 Coax, 50 Ohm								
Part No. PE3M0099					Cable Dia.	Attn. @ 1 GHz	Power @ 1 GHz	99
1 piece price shown. See web or call for volume pricing.					0.098" dia.	dB/100ft	W	
6"	8"	12"	16"	18"	24"	Custom Len.		
\$188.33	\$188.66	\$189.34	\$189.96	\$190.33	\$191.34	See Web		
M17/119-RG174-0XDS2 Coax, 50 Ohm								
Part No. PE3M0114					Cable Dia.	Attn. @ 1 GHz	Power @ 1 GHz	1
1 piece price shown. See web or call for volume pricing.					0.110" dia.	dB/100ft	W	
6"	8"	12"	16"	18"	24"	Custom Len.		
\$187.72	\$187.84	\$188.11	\$188.36	\$188.50	\$188.89	See Web		
M17/28-RG058-0XDS2 Coax, 50 Ohm								
Part No. PE3M0124					Cable Dia.	Attn. @ 1 GHz	Power @ 1 GHz	2
1 piece price shown. See web or call for volume pricing.					0.195" dia.	dB/100ft	W	
12"	18"	24"	30"	36"	48"	Custom Len.		
\$259.93	\$260.52	\$261.12	\$261.71	\$262.32	\$263.51	See Web		
 <p>TNC MALE TO BNC MALE</p>								
Low Loss Flexible Cable Assemblies								
PE-C195 Coax, 50 Ohm								
Part No. PE37885					Cable Dia.	Attn. @ 1 GHz	Power @ 1 GHz	3
1 piece price shown. See web or call for volume pricing.					0.195" dia.	11 dB/100ft	150 W	
12"	24"	36"	48"	60"	-	Custom Len.		
\$30.92	\$31.64	\$32.35	\$35.78	\$36.58	-	See Web		
PE-C240 Coax, 50 Ohm								

Part No. PE37594					Cable Dia.	Attn. @ 1 GHz	Power @ 1 GHz	4
1 piece price shown. See web or call for volume pricing.					0.240" dia.	9 dB/100ft	250 W	
12"	24"	36"	48"	60"	-	Custom Len.		
\$41.18	\$41.67	\$44.49	\$47.25	\$50.07	-	See Web		
Standard Flexible Cable Assemblies								
RG58C/U Coax, 50 Ohm								
Part No. PE3497					Cable Dia.	Attn. @ 1 GHz	Power @ 1 GHz	5
1 piece price shown. See web or call for volume pricing.					0.195" dia.	20 dB/100ft	44 W	
12"	24"	36"	48"	60"	72"	Custom Len.		
\$37.12	\$37.94	\$38.75	\$37.24	\$37.98	\$41.27	See Web		
RG58-P Coax, 50 Ohm								
Part No. PE35789					Cable Dia.	Attn. @ 1 GHz	Power @ 1 GHz	6
1 piece price shown. See web or call for volume pricing.					0.159" dia.	17 dB/100ft	632 W	
12"	24"	36"	48"	60"	-	Custom Len.		
\$49.65	\$54.64	\$59.65	\$64.64	\$69.64	-	See Web		
RG142B/U Coax, 50 Ohm								
Part No. PE3551					Cable Dia.	Attn. @ 1 GHz	Power @ 1 GHz	7
1 piece price shown. See web or call for volume pricing.					0.195" dia.	13 dB/100ft	650 W	
12"	24"	36"	48"	60"	72"	Custom Len.		
\$40.37	\$46.10	\$54.94	\$57.57	\$63.30	\$69.03	See Web		
RG174A/U Coax, 50 Ohm								
Part No. PE3C3400					Cable Dia.	Attn. @ 1 GHz	Power @ 1 GHz	8
1 piece price shown. See web or call for volume pricing.					0.110" dia.	32 dB/100ft	17 W	
12"	24"	36"	48"	60"	72"	Custom Len.		
\$44.39	\$44.83	\$45.25	\$45.65	\$46.11	\$46.52	See Web		
RG188A/U Coax, 50 Ohm								
Part No. PE3C3401					Cable Dia.	Attn. @ 1 GHz	Power @ 1 GHz	9
1 piece price shown. See web or call for volume pricing.					0.110" dia.	26 dB/100ft	160 W	
12"	24"	36"	48"	60"	72"	Custom Len.		
\$46.00	\$48.07	\$55.59	\$52.18	\$54.26	\$56.28	See Web		
RG213/U Coax, 50 Ohm								
Part No. PE33969					Cable Dia.	Attn. @ 1 GHz	Power @ 1 GHz	10
1 piece price shown. See web or call for volume pricing.					0.405" dia.	8 dB/100ft	190 W	
12"	24"	36"	48"	60"	72"	Custom Len.		
\$72.04	\$73.71	\$75.37	\$77.03	\$78.69	\$80.36	See Web		
RG214/U Coax, 50 Ohm								
Part No. PE33701					Cable Dia.	Attn. @ 1 GHz	Power @ 1 GHz	11
1 piece price shown. See web or call for volume pricing.					0.425" dia.	7 dB/100ft	190 W	
12"	24"	36"	48"	60"	72"	Custom Len.		
\$82.47	\$89.79	\$97.12	\$104.45	\$111.77	\$127.07	See Web		
RG223/U Coax, 50 Ohm								
Part No. PE3498					Cable Dia.	Attn. @ 1 GHz	Power @ 1 GHz	12
1 piece price shown. See web or call for volume pricing.					0.210" dia.	13 dB/100ft	53 W	
12"	24"	36"	48"	60"	72"	Custom Len.		
\$36.85	\$43.65	\$46.77	\$50.06	\$48.45	\$56.41	See Web		
RG316/U Coax, 50 Ohm								
Part No. PE3C3393					Cable Dia.	Attn. @ 1 GHz	Power @ 1 GHz	13
1 piece price shown. See web or call for volume pricing.					0.102" dia.	38 dB/100ft	160 W	
12"	24"	36"	48"	60"	72"	Custom Len.		
\$45.82	\$48.71	\$54.82	\$58.12	\$57.37	\$60.26	See Web		
RG393/U Coax, 50 Ohm								
Part No. PE37859					Cable Dia.	Attn. @ 1 GHz	Power @ 1 GHz	14
1 piece price shown. See web or call for volume pricing.					0.390" dia.	9 dB/100ft	1700 W	
12"	24"	36"	48"	60"	-	Custom Len.		
\$75.94	\$96.91	\$104.81	\$119.27	\$133.68	-	See Web		
RG400/U Coax, 50 Ohm								
Part No. PE33535					Cable Dia.	Attn. @ 1 GHz	Power @ 1 GHz	15
1 piece price shown. See web or call for volume pricing.					0.195" dia.	15 dB/100ft	650 W	
12"	24"	36"	48"	60"	72"	Custom Len.		
\$48.63	\$58.94	\$62.56	\$74.15	\$81.70	\$89.24	See Web		
PE-P195 Coax, 50 Ohm								
Part No. PE37478					Cable Dia.	Attn. @ 1 GHz	Power @ 1 GHz	16
1 piece price shown. See web or call for volume pricing.					0.195" dia.	13 dB/100ft	650 W	
12"	24"	36"	48"	60"	-	Custom Len.		
\$40.83	\$49.06	\$57.21	\$65.37	\$73.54	-	See Web		
RG59B/U Coax, 75 Ohm								
Part No. PE3023					Cable Dia.	Attn. @ 1 GHz	Power @ 1 GHz	17
1 piece price shown. See web or call for volume pricing.					0.242" dia.	12 dB/100ft	77 W	
12"	24"	36"	48"	60"	72"	Custom Len.		
\$35.21	\$38.36	\$39.40	\$38.09	\$39.05	\$42.62	See Web		
 <p>TNC MALE TO MINI UHF MALE</p>								
Low Loss Flexible Cable Assemblies								
LMR-195 Coax, 50 Ohm								
Part No. PE3C0047					Cable Dia.	Attn. @ 1 GHz	Power @ 1 GHz	18
1 piece price shown. See web or call for volume pricing.					0.195" dia.	12 dB/100ft	W	
12"	24"	36"	48"	60"	-	Custom Len.		
\$29.99	\$30.73	\$31.48	\$32.22	\$32.97	-	See Web		

Cable Assemblies

See Our Website For Current Pricing & Real-Time Stock Availability!

For Custom Lengths, Metric Lengths or Special Configurations, Please call (949) 261-1920

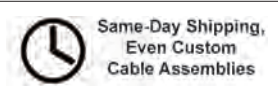

For our complete selection of cable assemblies, please visit our website

TNC MALE TO N MALE



Flexible Cable Assemblies

LMR-195 Coax, 50 Ohm

Part No.	PE3W01959	Cable Dia.	Attn. @ 1 GHz	Power @ 1 GHz
1 piece price shown. See web or call for volume pricing.				
12"	24"	36"	48"	60"
\$44.37	\$45.09	\$45.82	\$46.55	\$47.27

19

Low Loss Flexible Cable Assemblies

LMR-240 Coax, 50 Ohm

Part No.	PE3W04201	Cable Dia.	Attn. @ 1 GHz	Power @ 1 GHz
1 piece price shown. See web or call for volume pricing.				
12"	24"	36"	48"	60"
\$40.50	\$41.37	\$42.26	\$43.14	\$44.02

20

PE-P142LL-27478 Coax, 50 Ohm

Part No.	PE3M0162	Cable Dia.	Attn. @ 1 GHz	Power @ 1 GHz
1 piece price shown. See web or call for volume pricing.				
12"	18"	24"	36"	48"
\$378.40	\$386.88	\$395.36	\$412.32	\$429.27

21

PE-P160LL-27478 Coax, 50 Ohm

Part No.	PE3M0207	Cable Dia.	Attn. @ 1 GHz	Power @ 1 GHz
1 piece price shown. See web or call for volume pricing.				
8"	12"	18"	24"	30"
\$353.68	\$358.58	\$365.93	\$373.28	\$380.63

22

PE-P300LL-27478 Coax, 50 Ohm

Part No.	PE3M0240	Cable Dia.	Attn. @ 1 GHz	Power @ 1 GHz
1 piece price shown. See web or call for volume pricing.				
12"	18"	24"	36"	48"
\$414.08	\$428.23	\$442.39	\$470.69	\$498.99

23

TNC MALE TO N MALE RIGHT ANGLE



Low Loss Flexible Cable Assemblies

PE-P142LL-27478 Coax, 50 Ohm

Part No.	PE3M0164	Cable Dia.	Attn. @ 1 GHz	Power @ 1 GHz
1 piece price shown. See web or call for volume pricing.				
12"	18"	24"	36"	48"
\$493.43	\$501.91	\$510.39	\$527.34	\$544.30

24

PE-P160LL-27478 Coax, 50 Ohm

Part No.	PE3M0209	Cable Dia.	Attn. @ 1 GHz	Power @ 1 GHz
1 piece price shown. See web or call for volume pricing.				
8"	12"	18"	24"	30"
\$451.74	\$456.63	\$463.99	\$471.33	\$478.69

25

PE-P300LL-27478 Coax, 50 Ohm

Part No.	PE3M0242	Cable Dia.	Attn. @ 1 GHz	Power @ 1 GHz
1 piece price shown. See web or call for volume pricing.				
12"	18"	24"	36"	48"
\$559.02	\$573.17	\$587.33	\$615.63	\$643.93

26

TNC MALE TO N FEMALE BULKHEAD

SEE MOUNTING HOLE SECTION ON PAGE 369



Low Loss Flexible Cable Assemblies

PE-P142LL-27478 Coax, 50 Ohm

Part No.	PE3M0163	Cable Dia.	Attn. @ 1 GHz	Power @ 1 GHz
1 piece price shown. See web or call for volume pricing.				
12"	18"	24"	36"	48"
\$465.61	\$474.09	\$482.56	\$499.52	\$516.48

27

PE-P160LL-27478 Coax, 50 Ohm

Part No.	PE3M0208	Cable Dia.	Attn. @ 1 GHz	Power @ 1 GHz
1 piece price shown. See web or call for volume pricing.				
8"	12"	18"	24"	30"
\$455.66	\$460.57	\$467.92	\$475.27	\$482.63

28

PE-P300LL-27478 Coax, 50 Ohm

Part No.	PE3M0241	Cable Dia.	Attn. @ 1 GHz	Power @ 1 GHz
1 piece price shown. See web or call for volume pricing.				
12"	18"	24"	36"	48"
\$489.75	\$503.90	\$518.06	\$546.36	\$574.66

29

TNC MALE TO SMA MALE



Low Loss Flexible Cable Assemblies

LMR-195-FR Coax, 50 Ohm

Part No.	PE3W04028	Cable Dia.	Attn. @ 1 GHz	Power @ 1 GHz
1 piece price shown. See web or call for volume pricing.				
12"	24"	36"	48"	60"
\$27.94	\$39.76	\$40.76	\$41.76	\$42.75

30

TNC MALE TO SMA MALE RIGHT ANGLE



Flexible Cable Assemblies

LMR-200 Coax, 50 Ohm

Part No.	PE3W07265	Cable Dia.	Attn. @ 1 GHz	Power @ 1 GHz
1 piece price shown. See web or call for volume pricing.				
12"	24"	36"	48"	60"
\$60.05	\$60.77	\$61.49	\$62.20	\$62.92

31

TNC MALE TO SMB PLUG RIGHT ANGLE



Standard Flexible Cable Assemblies

RG174AU Coax, 50 Ohm

Part No.	PE3W00322	Cable Dia.	Attn. @ 1 GHz	Power @ 1 GHz
1 piece price shown. See web or call for volume pricing.				
12"	24"	36"	48"	60"
\$48.38	\$48.93	\$49.48	\$50.04	\$50.59

32

TNC MALE TO SMP FEMALE RIGHT ANGLE



Standard Flexible Cable Assemblies

RG316/U Coax, 50 Ohm

Part No.	PE3W05738	Cable Dia.	Attn. @ 1 GHz	Power @ 1 GHz
1 piece price shown. See web or call for volume pricing.				
12"	24"	36"	48"	60"
\$56.41	\$59.68	\$62.96	\$66.25	\$69.53

33

TNC MALE TO TNC MALE



Flexible Cable Assemblies

LMR-195-FR Coax, 50 Ohm

Part No.	PE3W05242	Cable Dia.	Attn. @ 1 GHz	Power @ 1 GHz
1 piece price shown. See web or call for volume pricing.				
12"	24"	36"	48"	60"
\$25.66	\$26.66	\$27.66	\$28.66	\$29.65

34

Precision Formable Cable Assemblies

PE-SR402FL Coax, 50 Ohm

Part No.	PE39479	Cable Dia.	Attn. @ 1 GHz	Power @ 1 GHz
1 piece price shown. See web or call for volume pricing.				
6"	9"	12"	18"	24"
\$53.54	\$30.02	\$57.47	\$47.63	\$51.34

35

Low Loss Flexible Cable Assemblies

PE-C195 Coax, 50 Ohm

Part No.	PE36555	Cable Dia.	Attn. @ 1 GHz	Power @ 1 GHz
1 piece price shown. See web or call for volume pricing.				
12"	24"	36"	48"	60"
\$38.73	\$39.51	\$36.65	\$41.12	\$41.92

36

PE-C240 Coax, 50 Ohm

Part No.	PE35997	Cable Dia.	Attn. @ 1 GHz	Power @ 1 GHz
1 piece price shown. See web or call for volume pricing.				
12"	24"	36"	48"	60"
\$44.48	\$42.93	\$44.49	\$47.25	\$49.11

37

PE-C300 Coax, 50 Ohm

Part No.	PE35100	Cable Dia.	Attn. @ 1 GHz	Power @ 1 GHz
1 piece price shown. See web or call for volume pricing.				
12"	24"	36"	48"	60"
\$58.42	\$61.26	\$64.09	\$66.92	\$69.76

38

PE-C400 Coax, 50 Ohm

Part No.	PE35886	Cable Dia.	Attn. @ 1 GHz	Power @ 1 GHz
1 piece price shown. See web or call for volume pricing.				
12"	24"	36"	48"	60"
\$90.87	\$87.04	\$90.46	\$95.27	\$96.94

39

LMR-100A-PVC Coax, 50 Ohm

Part No.	PE3C0115	Cable Dia.	Attn. @ 1 GHz	Power @ 1 GHz
1 piece price shown. See web or call for volume pricing.				
12"	24"	36"	48"	60"
\$58.32	\$59.08	\$63.34	\$64.14	\$64.92

40

LMR-400-DB Coax, 50 Ohm

Part No.	PE3W00572	Cable Dia.	Attn. @ 1 GHz	Power @ 1 GHz
1 piece price shown. See web or call for volume pricing.				
12"	24"	36"	48"	60"
\$79.12	\$80.56	\$82.01	\$83.44	\$84.89

41

LMR-195 Coax, 50 Ohm

Cable Assemblies

See Our Website For Current Pricing & Real-Time Stock Availability!

*Coax Performance at 1 GHz Notes: Cable assembly max frequency may be lower than connector or coax max frequency

For our complete selection of cable assemblies, please visit our website

Part No.	Cable Dia.				Attn. @ 1 GHz	Power @ 1 GHz
Part No. PE3C0042	0.195" dia.				12 dB/100ft	W
1 piece price shown. See web or call for volume pricing.	12"	24"	36"	48"	60"	Custom Len.
	\$35.86	\$36.60	\$37.36	\$38.15	\$38.91	See Web
Part No. PE3C0117	0.195" dia.				12 dB/100ft	W
1 piece price shown. See web or call for volume pricing.	12"	24"	36"	48"	60"	Custom Len.
	\$50.64	\$53.41	\$54.16	\$54.95	\$53.63	See Web
PE-P142LL-27478 Coax, 50 Ohm						
Part No. PE3M0159	0.195" dia.				dB/100ft	W
1 piece price shown. See web or call for volume pricing.	12"	18"	24"	36"	48"	60"
	\$386.76	\$395.24	\$403.71	\$420.67	\$437.63	\$454.58
PE-P160LL-27478 Coax, 50 Ohm						
Part No. PE3M0204	0.160" dia.				dB/100ft	W
1 piece price shown. See web or call for volume pricing.	8"	12"	18"	24"	30"	36"
	\$366.73	\$371.62	\$378.98	\$386.32	\$393.68	\$401.02
PE-P300LL-27478 Coax, 50 Ohm						
Part No. PE3M0238	0.300" dia.				dB/100ft	W
1 piece price shown. See web or call for volume pricing.	12"	18"	24"	36"	48"	60"
	\$410.09	\$424.24	\$438.40	\$466.70	\$495.00	\$523.30
PE-P160LL Coax, 50 Ohm						
Part No. PE3C5249	0.160" dia.				dB/100ft	W
1 piece price shown. See web or call for volume pricing.	12"	24"	36"	48"	60"	50CM
	\$205.44	\$226.16	\$246.87	\$267.58	\$288.29	\$218.71
Low Loss Test Flexible Cable Assemblies						
PE-P300LL Coax, 50 Ohm						
Part No. PE3334	0.300" dia.				5 dB/100ft	W
1 piece price shown. See web or call for volume pricing.	12"	24"	36"	48"	60"	50CM
	\$314.04	\$339.97	\$365.92	\$391.86	\$417.78	\$330.66
PE-P142LL Coax, 50 Ohm						
Part No. PE347	0.195" dia.				7 dB/100ft	W
1 piece price shown. See web or call for volume pricing.	12"	24"	36"	48"	60"	50CM
	\$155.85	\$172.09	\$188.33	\$204.56	\$220.80	\$166.25
Standard Formable Cable Assemblies						
PE-SR401FL Coax, 50 Ohm						
Part No. PE34282	" dia.				8 dB/100ft	1400 W
1 piece price shown. See web or call for volume pricing.	6"	12"	18"	24"	36"	48"
	\$170.58	\$170.58	\$178.29	\$185.99	\$201.39	\$216.80
PE-SR402FL Coax, 50 Ohm						
Part No. PE3466	" dia.				12 dB/100ft	450 W
1 piece price shown. See web or call for volume pricing.	6"	12"	18"	24"	36"	48"
	\$92.60	\$92.60	\$96.36	\$100.13	\$114.31	\$122.86
Standard Flexible Cable Assemblies						
RG8A/U Coax, 50 Ohm						
Part No. PE3418	0.405" dia.				8 dB/100ft	190 W
1 piece price shown. See web or call for volume pricing.	12"	24"	36"	48"	60"	72"
	\$66.70	\$65.62	\$68.39	\$71.08	\$73.84	\$76.61
RG8X Coax, 50 Ohm						
Part No. PE35671	0.242" dia.				14 dB/100ft	60 W
1 piece price shown. See web or call for volume pricing.	12"	24"	36"	48"	60"	Custom Len.
	\$66.46	\$70.00	\$67.12	\$69.94	\$72.77	See Web
RG58C/U Coax, 50 Ohm						
Part No. PE3394	0.195" dia.				20 dB/100ft	44 W
1 piece price shown. See web or call for volume pricing.	12"	18"	24"	30"	36"	48"
	\$37.05	\$37.46	\$37.86	\$38.28	\$38.68	\$39.54
RG142B/U Coax, 50 Ohm						
Part No. PE3544	0.195" dia.				13 dB/100ft	650 W
1 piece price shown. See web or call for volume pricing.	12"	24"	36"	48"	60"	72"
	\$47.76	\$53.84	\$59.92	\$66.35	\$72.54	\$78.75
RG174A/U Coax, 50 Ohm						
Part No. PE3425	0.100" dia.				32 dB/100ft	16 W
1 piece price shown. See web or call for volume pricing.	12"	24"	36"	48"	60"	72"
	\$62.41	\$62.85	\$67.32	\$67.93	\$64.15	\$64.58
RG188A/U Coax, 50 Ohm						
Part No. PE3434	0.110" dia.				26 dB/100ft	160 W
1 piece price shown. See web or call for volume pricing.	12"	24"	36"	48"	60"	72"
	\$63.17	\$65.38	\$67.61	\$69.82	\$72.03	\$74.26

Part No.	Cable Dia.				Attn. @ 1 GHz	Power @ 1 GHz
Part No. PE3421	0.405" dia.				8 dB/100ft	190 W
1 piece price shown. See web or call for volume pricing.	12"	24"	36"	48"	60"	72"
	\$66.80	\$68.46	\$70.11	\$71.78	\$73.44	\$75.11
RG214/U Coax, 50 Ohm						
Part No. PE3435	0.425" dia.				7 dB/100ft	190 W
1 piece price shown. See web or call for volume pricing.	12"	24"	36"	48"	60"	72"
	\$89.99	\$103.16	\$110.94	\$119.18	\$119.29	\$135.04
RG23/U Coax, 50 Ohm						
Part No. PE3414	0.210" dia.				13 dB/100ft	53 W
1 piece price shown. See web or call for volume pricing.	12"	24"	36"	48"	60"	72"
	\$46.53	\$49.63	\$52.75	\$56.04	\$59.22	\$62.39
RG303/U Coax, 50 Ohm						
Part No. PE33013	0.170" dia.				14 dB/100ft	650 W
1 piece price shown. See web or call for volume pricing.	12"	24"	36"	48"	60"	Custom Len.
	\$41.92	\$48.36	\$51.01	\$56.75	\$68.16	See Web
RG316/U Coax, 50 Ohm						
Part No. PE3747	0.098" dia.				38 dB/100ft	160 W
1 piece price shown. See web or call for volume pricing.	12"	24"	36"	48"	60"	72"
	\$64.06	\$66.95	\$69.83	\$78.75	\$75.62	\$85.11
RG316-DS Coax, 50 Ohm						
Part No. PE34316	0.114" dia.				26 dB/100ft	160 W
1 piece price shown. See web or call for volume pricing.	12"	24"	36"	48"	60"	Custom Len.
	\$58.43	\$61.34	\$69.35	\$67.16	\$70.07	See Web
RG393/U Coax, 50 Ohm						
Part No. PE33185	0.390" dia.				8 dB/100ft	1700 W
1 piece price shown. See web or call for volume pricing.	12"	24"	36"	48"	60"	Custom Len.
	\$95.58	\$111.98	\$121.10	\$145.75	\$152.03	See Web
RG400/U Coax, 50 Ohm						
Part No. PE3608	0.195" dia.				15 dB/100ft	650 W
1 piece price shown. See web or call for volume pricing.	12"	24"	36"	48"	60"	Custom Len.
	\$57.17	\$61.93	\$71.95	\$75.87	\$87.32	\$94.85
PE-P141EAM Coax, 50 Ohm						
Part No. PE3CA1043	0.163" dia.				dB/100ft	W
1 piece price shown. See web or call for volume pricing.	12"	24"	36"	-	-	Custom Len.
	\$255.96	\$296.80	\$288.60	-	-	See Web
PE-P195 Coax, 50 Ohm						
Part No. PE35711	0.195" dia.				13 dB/100ft	650 W
1 piece price shown. See web or call for volume pricing.	12"	24"	36"	48"	60"	Custom Len.
	\$48.52	\$56.68	\$70.59	\$73.01	\$81.23	See Web
LMR-400-UF Coax, 50 Ohm						
Part No. PE3W00808	0.405" dia.				5 dB/100ft	W
1 piece price shown. See web or call for volume pricing.	12"	24"	36"	48"	60"	50CM
	\$80.31	\$82.87	\$85.43	\$87.98	\$90.54	\$81.96
Standard Semi-Rigid Cable Assemblies						
PE-SR402AL Coax, 50 Ohm						
Part No. PE34279	0.141" dia.				13 dB/100ft	450 W
1 piece price shown. See web or call for volume pricing.	6"	12"	18"	24"	36"	48"
	\$84.60	\$89.15	\$93.71	\$98.27	\$107.40	\$116.50
RG401/U Coax, 50 Ohm						
Part No. PE34271	" dia.				8 dB/100ft	870 W
1 piece price shown. See web or call for volume pricing.	6"	12"	18"	24"	36"	48"
	\$173.00	\$184.01	\$177.96	\$188.59	\$209.90	\$253.33
RG402/U Coax, 50 Ohm						
Part No. PE3074	" dia.				11 dB/100ft	450 W
1 piece price shown. See web or call for volume pricing.	6"	12"	18"	24"	36"	48"
	\$92.33	\$92.33	\$95.97	\$99.63	\$113.51	\$114.24
PE-SR401AL-STRAIGHT Coax, 50 Ohm						
Part No. PE34275	0.250" dia.				8 dB/100ft	1400 W
1 piece price shown. See web or call for volume pricing.	6"	12"	18"	24"	36"	48"
	\$154.80	\$163.57	\$172.38	\$181.16	\$198.74	\$216.32
Standard Flexible Cable Assemblies						
RG55B/U Coax, 53 Ohm						
Part No. PE3504	0.202" dia.				17 dB/100ft	53 W
1 piece price shown. See web or call for volume pricing.	12"	24"	36"	48"	60"	72"
	\$43.00	\$45.25	\$47.49	\$49.73	\$51.97	\$54.22

Cable Assemblies



See Our Website For Current Pricing & Real-Time Stock Availability!

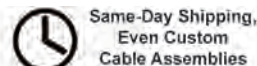
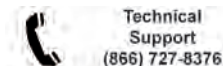

For Custom Lengths, Metric Lengths or Special Configurations, Please call (949) 261-1920



For our complete selection of cable assemblies, please visit our website

Cable Assemblies
See Our Website For Current Pricing & Real-Time Stock Availability!

RG59B/U Coax, 75 Ohm						
Part No. PE3402	Cable Dia.	Attn. @ 1 GHz	Power @ 1 GHz			
1 piece price shown. See web or call for volume pricing.	0.242" dia.	12 dB/100ft	77 W			
12"	18"	24"	30"	36"	48"	Custom Len.
\$37.42	\$37.91	\$40.71	\$38.86	\$39.35	\$40.30	See Web
RG179B/U Coax, 75 Ohm						
Part No. PE3430	Cable Dia.	Attn. @ 1 GHz	Power @ 1 GHz			
1 piece price shown. See web or call for volume pricing.	0.100" dia.	25 dB/100ft	200 W			
12"	24"	36"	48"	60"	72"	Custom Len.
\$63.41	\$65.79	\$68.15	\$70.51	\$72.88	\$75.23	See Web
RG62A/U Coax, 93 Ohm						
Part No. PE3408	Cable Dia.	Attn. @ 1 GHz	Power @ 1 GHz			
1 piece price shown. See web or call for volume pricing.	0.242" dia.	13 dB/100ft	77 W			
12"	24"	36"	48"	60"	72"	Custom Len.
\$37.88	\$39.25	\$43.99	\$42.00	\$43.37	\$44.74	See Web
TNC MALE TO TNC MALE RIGHT ANGLE 						
Precision Formable Cable Assemblies						
PE-SR402FL Coax, 50 Ohm						
Part No. PE39481	Cable Dia.	Attn. @ 1 GHz	Power @ 1 GHz			
1 piece price shown. See web or call for volume pricing.	. dia.	12 dB/100ft	450 W			
6"	9"	12"	18"	24"	-	Custom Len.
\$50.83	\$44.47	\$46.36	\$59.74	\$58.15	-	See Web
Low Loss Flexible Cable Assemblies						
LMR-195 Coax, 50 Ohm						
Part No. PE3C0058	Cable Dia.	Attn. @ 1 GHz	Power @ 1 GHz			
1 piece price shown. See web or call for volume pricing.	0.195" dia.	12 dB/100ft	W			
12"	24"	36"	48"	60"	-	Custom Len.
\$46.81	\$50.36	\$51.12	\$51.91	\$52.67	-	See Web
PE-P142LL-27478 Coax, 50 Ohm						
Part No. PE3M0161	Cable Dia.	Attn. @ 1 GHz	Power @ 1 GHz			
1 piece price shown. See web or call for volume pricing.	0.195" dia.	dB/100ft	W			
12"	18"	24"	36"	48"	60"	Custom Len.
\$493.43	\$501.91	\$510.39	\$527.34	\$544.30	\$561.26	See Web
PE-P160LL-27478 Coax, 50 Ohm						
Part No. PE3M0206	Cable Dia.	Attn. @ 1 GHz	Power @ 1 GHz			
1 piece price shown. See web or call for volume pricing.	0.160" dia.	dB/100ft	W			
8"	12"	18"	24"	30"	36"	Custom Len.
\$451.74	\$456.63	\$463.99	\$471.33	\$478.69	\$486.03	See Web
PE-P300LL-27478 Coax, 50 Ohm						
Part No. PE3M0239	Cable Dia.	Attn. @ 1 GHz	Power @ 1 GHz			
1 piece price shown. See web or call for volume pricing.	0.300" dia.	dB/100ft	W			
12"	18"	24"	36"	48"	60"	Custom Len.
\$554.38	\$568.53	\$582.68	\$610.98	\$639.29	\$667.59	See Web
PE-P160LL Coax, 50 Ohm						
Part No. PE3C5252	Cable Dia.	Attn. @ 1 GHz	Power @ 1 GHz			
1 piece price shown. See web or call for volume pricing.	0.160" dia.	dB/100ft	W			
12"	24"	36"	48"	60"	50CM	Custom Len.
\$264.21	\$284.92	\$305.63	\$326.35	\$347.06	\$277.48	See Web
Low Loss Test Flexible Cable Assemblies						
PE-P142LL Coax, 50 Ohm						
Part No. PE346	Cable Dia.	Attn. @ 1 GHz	Power @ 1 GHz			
1 piece price shown. See web or call for volume pricing.	0.195" dia.	7 dB/100ft	W			
12"	24"	36"	48"	60"	50CM	Custom Len.
\$239.33	\$255.56	\$271.80	\$288.04	\$304.27	\$249.73	See Web
Standard Flexible Cable Assemblies						
RG142B/U Coax, 50 Ohm						
Part No. PE33867	Cable Dia.	Attn. @ 1 GHz	Power @ 1 GHz			
1 piece price shown. See web or call for volume pricing.	0.195" dia.	13 dB/100ft	650 W			
12"	24"	36"	48"	60"	-	Custom Len.
\$62.75	\$68.82	\$74.90	\$81.33	\$87.53	-	See Web
PE-P141EAM Coax, 50 Ohm						
Part No. PE3CA1044	Cable Dia.	Attn. @ 1 GHz	Power @ 1 GHz			
1 piece price shown. See web or call for volume pricing.	0.163" dia.	dB/100ft	W			
12"	24"	36"	-	-	-	Custom Len.
\$372.53	\$348.93	\$365.24	-	-	-	See Web
TNC MALE TO TNC FEMALE 						
Precision Formable Cable Assemblies						
PE-SR405FLJ Coax, 50 Ohm						
Part No. PE39488	Cable Dia.	Attn. @ 1 GHz	Power @ 1 GHz			
1 piece price shown. See web or call for volume pricing.	0.098" dia.	20 dB/100ft	130 W			
6"	9"	12"	18"	24"	-	Custom Len.
\$46.05	\$46.47	\$46.47	\$50.35	\$54.23	-	See Web
Standard Formable Cable Assemblies						
PE-SR402FLJ Coax, 50 Ohm						





Part No. PE39496				Cable Dia.	Attn. @ 1 GHz	Power @ 1 GHz
1 piece price shown. See web or call for volume pricing.				0.161" dia.	12 dB/100ft	303 W
6"	9"	12"	18"	24"	-	Custom Len.
\$46.28	\$46.28	\$46.28	\$53.21	\$53.83	-	See Web
TNC MALE TO TNC FEMALE BULKHEAD 						
SEE MOUNTING HOLE SECTION ON PAGE 369						
Low Loss Flexible Cable Assemblies						
LMR-195 Coax, 50 Ohm						
Part No. PE3W00780	Cable Dia.	Attn. @ 1 GHz	Power @ 1 GHz			
1 piece price shown. See web or call for volume pricing.	0.195" dia.	12 dB/100ft	W			
12"	24"	36"	48"	60"	50CM	Custom Len.
\$38.47	\$38.55	\$38.62	\$38.70	\$38.78	\$38.52	See Web
PE-P142LL-27478 Coax, 50 Ohm						
Part No. PE3M0160	Cable Dia.	Attn. @ 1 GHz	Power @ 1 GHz			
1 piece price shown. See web or call for volume pricing.	0.195" dia.	dB/100ft	W			
12"	18"	24"	36"	48"	60"	Custom Len.
\$465.61	\$474.09	\$482.56	\$499.52	\$516.48	\$533.43	See Web
PE-P160LL-27478 Coax, 50 Ohm						
Part No. PE3M0205	Cable Dia.	Attn. @ 1 GHz	Power @ 1 GHz			
1 piece price shown. See web or call for volume pricing.	0.160" dia.	dB/100ft	W			
8"	12"	18"	24"	30"	36"	Custom Len.
\$447.80	\$452.69	\$460.05	\$467.39	\$474.75	\$482.10	See Web
PE-P160LL Coax, 50 Ohm						
Part No. PE3C5253	Cable Dia.	Attn. @ 1 GHz	Power @ 1 GHz			
1 piece price shown. See web or call for volume pricing.	0.160" dia.	dB/100ft	W			
12"	24"	36"	48"	60"	50CM	Custom Len.
\$231.73	\$252.45	\$273.15	\$293.87	\$314.58	\$245.00	See Web
Standard Flexible Cable Assemblies						
PE-P141EAM Coax, 50 Ohm						
Part No. PE3CA1046	Cable Dia.	Attn. @ 1 GHz	Power @ 1 GHz			
1 piece price shown. See web or call for volume pricing.	0.163" dia.	dB/100ft	W			
12"	24"	36"	-	-	-	Custom Len.
\$360.90	\$338.55	\$354.86	-	-	-	See Web
TNC MALE TO REVERSE POLARITY TNC MALE 						
Low Loss Flexible Cable Assemblies						
PE-C195 Coax, 50 Ohm						
Part No. PE37137	Cable Dia.	Attn. @ 1 GHz	Power @ 1 GHz			
1 piece price shown. See web or call for volume pricing.	0.195" dia.	11 dB/100ft	150 W			
12"	24"	36"	48"	60"	-	Custom Len.
\$33.51	\$34.17	\$34.84	\$39.24	\$36.16	-	See Web
Standard Flexible Cable Assemblies						
RG58C/U Coax, 50 Ohm						
Part No. PE35228	Cable Dia.	Attn. @ 1 GHz	Power @ 1 GHz			
1 piece price shown. See web or call for volume pricing.	0.195" dia.	20 dB/100ft	44 W			
12"	24"	36"	48"	60"	72"	Custom Len.
\$40.23	\$38.68	\$39.45	\$40.18	\$40.90	\$44.38	See Web
RG142B/U Coax, 50 Ohm						
Part No. PE35230	Cable Dia.	Attn. @ 1 GHz	Power @ 1 GHz			
1 piece price shown. See web or call for volume pricing.	0.195" dia.	13 dB/100ft	650 W			
12"	24"	36"	48"	60"	72"	Custom Len.
\$45.58	\$51.32	\$57.05	\$62.78	\$68.50	\$74.24	See Web
RG214/U Coax, 50 Ohm						
Part No. PE35234	Cable Dia.	Attn. @ 1 GHz	Power @ 1 GHz			
1 piece price shown. See web or call for volume pricing.	0.425" dia.	7 dB/100ft	190 W			
12"	24"	36"	48"	60"	72"	Custom Len.
\$81.82	\$89.22	\$105.56	\$103.97	\$111.35	\$118.74	See Web
RG223/U Coax, 50 Ohm						
Part No. PE35236	Cable Dia.	Attn. @ 1 GHz	Power @ 1 GHz			
1 piece price shown. See web or call for volume pricing.	0.210" dia.	13 dB/100ft	53 W			
12"	24"	36"	48"	60"	72"	Custom Len.
\$42.77	\$43.30	\$46.18	\$49.12	\$51.99	\$58.64	See Web
REVERSE POLARITY TNC MALE TO BNC MALE 						
Standard Flexible Cable Assemblies						
RG58C/U Coax, 50 Ohm						
Part No. PE35229	Cable Dia.	Attn. @ 1 GHz	Power @ 1 GHz			
1 piece price shown. See web or call for volume pricing.	0.195" dia.	20 dB/100ft	44 W			
12"	24"	36"	48"	60"	72"	Custom Len.
\$41.15	\$41.89	\$42.63	\$43.37	\$44.11	\$44.83	See Web
RG142B/U Coax, 50 Ohm						
Part No. PE35231	Cable Dia.	Attn. @ 1 GHz	Power @ 1 GHz			
1 piece price shown. See web or call for volume pricing.	0.195" dia.	13 dB/100ft	650 W			
12"	24"	36"	48"	60"	72"	Custom Len.
\$40.23	\$45.95	\$51.68	\$57.42	\$63.14	\$68.89	See Web



*Coax Performance at 1 GHz Notes: Cable assembly max frequency may be lower than connector or coax max frequency

For our complete selection of cable assemblies, please visit our website

Cable Assemblies

See Our Website For Current Pricing & Real-Time Stock Availability!

TNC MALE RIGHT ANGLE TO N MALE						
						
Low Loss Flexible Cable Assemblies						
PE-P142LL Coax, 50 Ohm						
Part No. PE3C1041	Cable Dia.			Attn. @ 1 GHz	Power @ 1 GHz	
1 piece price shown. See web or call for volume pricing.						
12"	24"	36"	48"	0.195" dia.	10 dB/100ft	W
\$215.21	\$244.36	\$246.73	\$262.49	\$278.24	\$225.32	See Web
PE-P142LL-27478 Coax, 50 Ohm						
Part No. PE3M0171	Cable Dia.			Attn. @ 1 GHz	Power @ 1 GHz	
1 piece price shown. See web or call for volume pricing.						
12"	18"	24"	36"	0.195" dia.	dB/100ft	W
\$485.09	\$493.57	\$502.04	\$519.00	\$535.96	\$552.91	See Web
PE-P160LL-27478 Coax, 50 Ohm						
Part No. PE3M0216	Cable Dia.			Attn. @ 1 GHz	Power @ 1 GHz	
1 piece price shown. See web or call for volume pricing.						
8"	12"	18"	24"	0.160" dia.	dB/100ft	W
\$438.69	\$443.59	\$450.94	\$458.29	\$465.64	\$472.99	See Web
PE-P300LL-27478 Coax, 50 Ohm						
Part No. PE3M0244	Cable Dia.			Attn. @ 1 GHz	Power @ 1 GHz	
1 piece price shown. See web or call for volume pricing.						
12"	18"	24"	36"	0.300" dia.	dB/100ft	W
\$558.37	\$572.52	\$586.67	\$614.97	\$643.28	\$671.58	See Web
TNC MALE RIGHT ANGLE TO N MALE RIGHT ANGLE						
						
Low Loss Flexible Cable Assemblies						
PE-P142LL-27478 Coax, 50 Ohm						
Part No. PE3M0173	Cable Dia.			Attn. @ 1 GHz	Power @ 1 GHz	
1 piece price shown. See web or call for volume pricing.						
12"	18"	24"	36"	0.195" dia.	dB/100ft	W
\$600.12	\$608.59	\$617.07	\$634.03	\$650.99	\$667.94	See Web
PE-P160LL-27478 Coax, 50 Ohm						
Part No. PE3M0218	Cable Dia.			Attn. @ 1 GHz	Power @ 1 GHz	
1 piece price shown. See web or call for volume pricing.						
8"	12"	18"	24"	0.160" dia.	dB/100ft	W
\$536.74	\$541.64	\$549.00	\$556.34	\$563.70	\$571.04	See Web
PE-P300LL-27478 Coax, 50 Ohm						
Part No. PE3M0246	Cable Dia.			Attn. @ 1 GHz	Power @ 1 GHz	
1 piece price shown. See web or call for volume pricing.						
12"	18"	24"	36"	0.300" dia.	dB/100ft	W
\$703.31	\$717.46	\$731.61	\$759.91	\$788.22	\$816.52	See Web
TNC MALE RIGHT ANGLE TO N FEMALE BULKHEAD						
SEE MOUNTING HOLE SECTION ON PAGE 369						
Low Loss Flexible Cable Assemblies						
PE-P142LL-27478 Coax, 50 Ohm						
Part No. PE3M0172	Cable Dia.			Attn. @ 1 GHz	Power @ 1 GHz	
1 piece price shown. See web or call for volume pricing.						
12"	18"	24"	36"	0.195" dia.	dB/100ft	W
\$572.29	\$580.77	\$589.25	\$606.20	\$623.16	\$640.12	See Web
PE-P160LL-27478 Coax, 50 Ohm						
Part No. PE3M0217	Cable Dia.			Attn. @ 1 GHz	Power @ 1 GHz	
1 piece price shown. See web or call for volume pricing.						
8"	12"	18"	24"	0.160" dia.	dB/100ft	W
\$540.67	\$545.58	\$552.92	\$560.28	\$567.63	\$574.98	See Web
PE-P300LL-27478 Coax, 50 Ohm						
Part No. PE3M0245	Cable Dia.			Attn. @ 1 GHz	Power @ 1 GHz	
1 piece price shown. See web or call for volume pricing.						
12"	18"	24"	36"	0.300" dia.	dB/100ft	W
\$634.04	\$648.19	\$662.34	\$690.64	\$718.95	\$747.25	See Web
TNC MALE RIGHT ANGLE TO TNC MALE						
						
Standard Semi-Rigid Cable Assemblies						
PE-SR402AL Coax, 50 Ohm						
Part No. PE3W07649	Cable Dia.			Attn. @ 1 GHz	Power @ 1 GHz	
1 piece price shown. See web or call for volume pricing.						
12"	24"	36"	48"	0.160" dia.	dB/100ft	450 W
\$68.68	\$78.56	\$88.44	\$98.32	\$108.20	\$75.01	See Web
TNC MALE RIGHT ANGLE TO TNC MALE RIGHT ANGLE						
						
Precision Formable Cable Assemblies						
PE-SR402FLJ Coax, 50 Ohm						

Part No. PE39494	Cable Dia.			Attn. @ 1 GHz	Power @ 1 GHz	
1 piece price shown. See web or call for volume pricing.						
6"	9"	12"	18"	0.161" dia.	12 dB/100ft	450 W
\$51.62	\$51.62	\$51.62	\$55.39	\$59.17	-	See Web
PE-SR405FLJ Coax, 50 Ohm						
Part No. PE39486	Cable Dia.			Attn. @ 1 GHz	Power @ 1 GHz	
1 piece price shown. See web or call for volume pricing.						
6"	9"	12"	18"	0.098" dia.	20 dB/100ft	130 W
\$64.57	\$33.60	\$25.63	\$52.66	\$56.38	-	See Web
Low Loss Flexible Cable Assemblies						
PE-P142LL Coax, 50 Ohm						
Part No. PE3C1144	Cable Dia.			Attn. @ 1 GHz	Power @ 1 GHz	
1 piece price shown. See web or call for volume pricing.						
12"	24"	36"	48"	0.195" dia.	7 dB/100ft	W
\$325.84	\$342.08	\$358.30	\$374.54	\$390.78	\$336.24	See Web
PE-P142LL-27478 Coax, 50 Ohm						
Part No. PE3M0170	Cable Dia.			Attn. @ 1 GHz	Power @ 1 GHz	
1 piece price shown. See web or call for volume pricing.						
12"	18"	24"	36"	0.195" dia.	dB/100ft	W
\$600.12	\$608.64	\$617.07	\$634.03	\$650.99	\$667.94	See Web
PE-P160LL-27478 Coax, 50 Ohm						
Part No. PE3M0215	Cable Dia.			Attn. @ 1 GHz	Power @ 1 GHz	
1 piece price shown. See web or call for volume pricing.						
8"	12"	18"	24"	0.160" dia.	dB/100ft	W
\$536.74	\$541.64	\$549.00	\$556.34	\$563.70	\$571.04	See Web
PE-P300LL-27478 Coax, 50 Ohm						
Part No. PE3M0243	Cable Dia.			Attn. @ 1 GHz	Power @ 1 GHz	
1 piece price shown. See web or call for volume pricing.						
12"	18"	24"	36"	0.300" dia.	dB/100ft	W
\$698.67	\$712.82	\$726.97	\$755.27	\$783.57	\$811.87	See Web
PE-P160LL Coax, 50 Ohm						
Part No. PE3C5250	Cable Dia.			Attn. @ 1 GHz	Power @ 1 GHz	
1 piece price shown. See web or call for volume pricing.						
12"	24"	36"	48"	0.160" dia.	dB/100ft	W
\$322.97	\$343.69	\$364.40	\$385.11	\$405.82	\$336.24	See Web
Standard Flexible Cable Assemblies						
RG142B/U Coax, 50 Ohm						
Part No. PE3194	Cable Dia.			Attn. @ 1 GHz	Power @ 1 GHz	
1 piece price shown. See web or call for volume pricing.						
12"	24"	36"	48"	0.195" dia.	13 dB/100ft	W
\$79.16	\$85.24	\$86.15	\$91.89	-	-	See Web
RG400/U Coax, 50 Ohm						
Part No. PE3W00037	Cable Dia.			Attn. @ 1 GHz	Power @ 1 GHz	
1 piece price shown. See web or call for volume pricing.						
12"	24"	36"	48"	0.195" dia.	15 dB/100ft	650 W
\$93.47	\$101.07	\$108.69	\$116.31	\$123.92	\$98.34	See Web
TNC MALE RIGHT ANGLE TO TNC FEMALE						
						
Low Loss Flexible Cable Assemblies						
LMR-240 Coax, 50 Ohm						
Part No. PE3W06709	Cable Dia.			Attn. @ 1 GHz	Power @ 1 GHz	
1 piece price shown. See web or call for volume pricing.						
12"	18"	24"	36"	0.240" dia.	8 dB/100ft	W
\$53.30	\$53.72	\$54.15	\$55.00	\$55.85	\$56.70	See Web
TNC MALE RIGHT ANGLE TO TNC FEMALE BULKHEAD						
SEE MOUNTING HOLE SECTION ON PAGE 369						
Low Loss Flexible Cable Assemblies						
PE-P160LL Coax, 50 Ohm						
Part No. PE3C5254	Cable Dia.			Attn. @ 1 GHz	Power @ 1 GHz	
1 piece price shown. See web or call for volume pricing.						
12"	24"	36"	48"	0.160" dia.	dB/100ft	W
\$290.49	\$306.55	\$326.94	\$347.35	\$367.74	\$299.20	See Web
TNC FEMALE TO SMA MALE						
						
Standard Flexible Cable Assemblies						
RG55B/U Coax, 53 Ohm						
Part No. PE3W07646	Cable Dia.			Attn. @ 1 GHz	Power @ 1 GHz	
1 piece price shown. See web or call for volume pricing.						
12"	24"	36"	48"	0.202" dia.	dB/100ft	53 W
\$41.92	\$44.70	\$47.47	\$50.25	\$53.02	\$43.70	See Web
TNC FEMALE TO TNC MALE						
						
Standard Formable Cable Assemblies						

Continued on Next Page

For Custom Lengths, Metric Lengths or Special Configurations, Please call (949) 261-1920

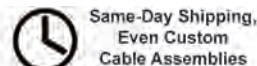
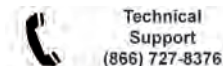

For our complete selection of cable assemblies, please visit our website

Cable Assemblies

See Our Website For Current Pricing & Real-Time Stock Availability!

PE-SR402FL Coax, 50 Ohm						
Part No. PE39482	Cable Dia.				Attn. @ 1 GHz	Power @ 1 GHz
1 piece price shown. See web or call for volume pricing.	" dia.				12 dB/100ft	400 W
6"	9"	12"	18"	24"	-	Custom Len.
\$46.47	\$46.47	\$46.47	\$56.74	\$57.34	-	See Web

REVERSE POLARITY TNC FEMALE TO REVERSE POLARITY SMA MALE						
						

Standard Flexible Cable Assemblies						
RG55B/U Coax, 53 Ohm						
Part No. PE3W07647	Cable Dia.				Attn. @ 1 GHz	Power @ 1 GHz
1 piece price shown. See web or call for volume pricing.	0.202" dia.				17 dB/100ft	53 W
12"	24"	36"	48"	60"	50CM	Custom Len.
\$47.27	\$50.05	\$52.82	\$55.60	\$58.37	\$49.05	See Web

TNC FEMALE BULKHEAD TO MCX PLUG RIGHT ANGLE						
SEE MOUNTING HOLE SECTION ON PAGE 369						
						

Precision Formable Cable Assemblies						
PE-SR405FL Coax, 50 Ohm						
Part No. PE39477	Cable Dia.				Attn. @ 1 GHz	Power @ 1 GHz
1 piece price shown. See web or call for volume pricing.	" dia.				23 dB/100ft	130 W
6"	9"	12"	18"	24"	-	Custom Len.
\$17.52	\$20.17	\$22.83	\$66.90	\$51.77	-	See Web

Standard Flexible Cable Assemblies						
PE-SR405FLJ Coax, 50 Ohm						
Part No. PE39491	Cable Dia.				Attn. @ 1 GHz	Power @ 1 GHz
1 piece price shown. See web or call for volume pricing.	0.098" dia.				20 dB/100ft	130 W
6"	9"	12"	18"	24"	-	Custom Len.
\$41.39	\$42.71	\$44.70	\$45.12	\$48.85	-	See Web

Standard Flexible Cable Assemblies						
RG174A/U Coax, 50 Ohm						
Part No. PE33799	Cable Dia.				Attn. @ 1 GHz	Power @ 1 GHz
1 piece price shown. See web or call for volume pricing.	0.100" dia.				32 dB/100ft	16 W
12"	24"	36"	48"	60"	-	Custom Len.
\$65.58	\$61.16	\$61.58	\$62.02	\$62.46	-	See Web

TNC FEMALE BULKHEAD TO MMCX PLUG RIGHT ANGLE						
SEE MOUNTING HOLE SECTION ON PAGE 369						
						

Precision Formable Cable Assemblies						
PE-SR405FL Coax, 50 Ohm						
Part No. PE39478	Cable Dia.				Attn. @ 1 GHz	Power @ 1 GHz
1 piece price shown. See web or call for volume pricing.	" dia.				23 dB/100ft	130 W
6"	9"	12"	18"	24"	-	Custom Len.
\$44.84	\$46.62	\$50.35	\$51.97	\$57.32	-	See Web

Standard Formable Cable Assemblies						
PE-SR405FLJ Coax, 50 Ohm						
Part No. PE39492	Cable Dia.				Attn. @ 1 GHz	Power @ 1 GHz
1 piece price shown. See web or call for volume pricing.	0.098" dia.				20 dB/100ft	130 W
6"	9"	12"	18"	24"	-	Custom Len.
\$42.87	\$44.95	\$47.01	\$51.29	\$55.56	-	See Web

Standard Flexible Cable Assemblies						
RG188A/U Coax, 50 Ohm						
Part No. PE35635	Cable Dia.				Attn. @ 1 GHz	Power @ 1 GHz
1 piece price shown. See web or call for volume pricing.	0.110" dia.				26 dB/100ft	160 W
12"	24"	36"	48"	60"	-	Custom Len.
\$72.14	\$74.63	\$77.12	\$73.45	\$75.67	-	See Web

Standard Flexible Cable Assemblies						
RG316/U Coax, 50 Ohm						
Part No. PE3W04293	Cable Dia.				Attn. @ 1 GHz	Power @ 1 GHz
1 piece price shown. See web or call for volume pricing.	0.098" dia.				58 dB/100ft	160 W
12"	24"	36"	48"	60"	50CM	Custom Len.
\$84.23	\$87.50	\$90.79	\$94.07	\$97.35	\$86.33	See Web

TNC FEMALE BULKHEAD TO N MALE						
SEE MOUNTING HOLE SECTION ON PAGE 369						
						

Low Loss Flexible Cable Assemblies						
PE-P142LL-27478 Coax, 50 Ohm						
Part No. PE3M0167	Cable Dia.				Attn. @ 1 GHz	Power @ 1 GHz
1 piece price shown. See web or call for volume pricing.	0.195" dia.				dB/100ft	W
12"	18"	24"	36"	48"	60"	Custom Len.
\$457.25	\$465.73	\$474.21	\$491.17	\$508.12	\$525.08	See Web

Standard Flexible Cable Assemblies						
PE-P160LL-27478 Coax, 50 Ohm						
Part No. PE3M0212	Cable Dia.				Attn. @ 1 GHz	Power @ 1 GHz
1 piece price shown. See web or call for volume pricing.	0.160" dia.				dB/100ft	W
8"	12"	18"	24"	30"	36"	Custom Len.
\$434.75	\$439.65	\$447.00	\$454.35	\$461.70	\$469.06	See Web

TNC FEMALE BULKHEAD TO N MALE RIGHT ANGLE						
SEE MOUNTING HOLE SECTION ON PAGE 369						
						

Low Loss Flexible Cable Assemblies						
PE-P142LL-27478 Coax, 50 Ohm						
Part No. PE3M0169	Cable Dia.				Attn. @ 1 GHz	Power @ 1 GHz
1 piece price shown. See web or call for volume pricing.	0.195" dia.				dB/100ft	W
12"	18"	24"	36"	48"	60"	Custom Len.
\$572.29	\$580.77	\$589.25	\$606.20	\$623.16	\$640.12	See Web

Standard Flexible Cable Assemblies						
PE-P160LL-27478 Coax, 50 Ohm						
Part No. PE3M0214	Cable Dia.				Attn. @ 1 GHz	Power @ 1 GHz
1 piece price shown. See web or call for volume pricing.	0.160" dia.				dB/100ft	W
8"	12"	18"	24"	30"	36"	Custom Len.
\$532.81	\$537.70	\$545.06	\$552.41	\$559.76	\$567.11	See Web

TNC FEMALE BULKHEAD TO N FEMALE BULKHEAD						
SEE MOUNTING HOLE SECTION ON PAGE 369						
						

Low Loss Flexible Cable Assemblies						
PE-P142LL-27478 Coax, 50 Ohm						
Part No. PE3M0168	Cable Dia.				Attn. @ 1 GHz	Power @ 1 GHz
1 piece price shown. See web or call for volume pricing.	0.195" dia.				dB/100ft	W
12"	18"	24"	36"	48"	60"	Custom Len.
\$544.46	\$552.94	\$561.41	\$578.37	\$595.33	\$612.28	See Web

Standard Flexible Cable Assemblies						
PE-P160LL-27478 Coax, 50 Ohm						
Part No. PE3M0213	Cable Dia.				Attn. @ 1 GHz	Power @ 1 GHz
1 piece price shown. See web or call for volume pricing.	0.160" dia.				dB/100ft	W
8"	12"	18"	24"	30"	36"	Custom Len.
\$536.74	\$541.64	\$549.00	\$556.34	\$563.70	\$571.04	See Web

TNC FEMALE BULKHEAD TO SMA MALE RIGHT ANGLE						
SEE MOUNTING HOLE SECTION ON PAGE 369						
						

Standard Formable Cable Assemblies						
PE-SR405FLJ Coax, 50 Ohm						
Part No. PE3W03175	Cable Dia.				Attn. @ 1 GHz	Power @ 1 GHz
1 piece price shown. See web or call for volume pricing.	0.105" dia.				20 dB/100ft	122 W
12"	18"	24"	36"	48"	60"	Custom Len.
\$68.50	\$72.81	\$77.12	\$85.74	\$94.36	\$102.98	See Web

Standard Flexible Cable Assemblies						
RG174A/U Coax, 50 Ohm						
Part No. PE3W03417	Cable Dia.				Attn. @ 1 GHz	Power @ 1 GHz
1 piece price shown. See web or call for volume pricing.	0.110" dia.				32 dB/100ft	17 W
12"	24"	36"	48"	60"	50CM	Custom Len.
\$65.08	\$65.64	\$66.21	\$66.77	\$67.33	\$65.44	See Web

Standard Flexible Cable Assemblies						
RG178B/U Coax, 50 Ohm						
Part No. PE3W05425	Cable Dia.				Attn. @ 1 GHz	Power @ 1 GHz
1 piece price shown. See web or call for volume pricing.	0.072" dia.				44 dB/100ft	55 W
12"	24"	36"	48"	60"	50CM	Custom Len.
\$69.73	\$70.85	\$71.98	\$73.11	\$74.25	\$70.44	See Web

TNC FEMALE BULKHEAD TO SMC PLUG RIGHT ANGLE						
SEE MOUNTING HOLE SECTION ON PAGE 369						
						

Standard Flexible Cable Assemblies						
RG174A/U Coax, 50 Ohm						
Part No. PE36779	Cable Dia.				Attn. @ 1 GHz	Power @ 1 GHz
1 piece price shown. See web or call for volume pricing.	0.100" dia.				32 dB/100ft	16 W
12"	24"	36"	48"	60"	-	Custom Len.
\$76.32	\$69.81	\$70.25	\$70.69	\$71.12	-	See Web

TNC FEMALE BULKHEAD TO SMP FEMALE RIGHT ANGLE						
SEE MOUNTING HOLE SECTION ON PAGE 369						
						

Standard Formable Cable Assemblies						
PE-SR405FL Coax, 50 Ohm						
Part No. PE3W05541	Cable Dia.				Attn. @ 1 GHz	Power @ 1 GHz
1 piece price shown. See web or call for volume pricing.	" dia.				23 dB/100ft	105 W
12"	24"	36"	48"	60"	50CM	Custom Len.
\$113.57	\$125.25	\$136.93	\$148.61	\$160.29	\$121.05	See Web

TNC FEMALE BULKHEAD TO SSMC PLUG RIGHT ANGLE						
SEE MOUNTING HOLE SECTION ON PAGE 369						
						

Standard Flexible Cable Assemblies						
RG188A/U Coax, 50 Ohm						
Part No. PE3W05752	Cable Dia.				Attn. @ 1 GHz	Power @ 1 GHz
1 piece price shown. See web or call for volume pricing.	0.110" dia.				26 dB/100ft	160 W
12"	24"	36"	48"	60"	50CM	Custom Len.
\$103.94	\$116.23	\$118.90	\$121.57	\$124.24	\$115.27	See Web

*Coax Performance at 1 GHz Notes: Cable assembly max frequency may be lower than connector or coax max frequency

For our complete selection of cable assemblies, please visit our website

TNC FEMALE BULKHEAD TO TNC MALE

SEE MOUNTING HOLE SECTION ON PAGE 369



Low Loss Flexible Cable Assemblies

PE-P142LL Coax, 50 Ohm

Part No. PE348	Cable Dia.	Attn. @ 1 GHz	Power @ 1 GHz
1 piece price shown. See web or call for volume pricing.	0.195" dia.	10 dB/100ft	W
12" 24" 36" 48"	60"	50CM	Custom Len.
\$198.94 \$215.17 \$231.41 \$247.65	\$263.87	\$209.35	See Web

45

TNC FEMALE BULKHEAD TO TNC MALE RIGHT ANGLE

SEE MOUNTING HOLE SECTION ON PAGE 369



Low Loss Flexible Cable Assemblies

PE-P142LL-27478 Coax, 50 Ohm

Part No. PE3M0166	Cable Dia.	Attn. @ 1 GHz	Power @ 1 GHz
1 piece price shown. See web or call for volume pricing.	0.195" dia.	dB/100ft	W
12" 18" 24" 36"	48"	60"	Custom Len.
\$572.29 \$580.77 \$589.25 \$606.20	\$623.16	\$640.12	See Web

46

PE-P160LL-27478 Coax, 50 Ohm

Part No. PE3M0211	Cable Dia.	Attn. @ 1 GHz	Power @ 1 GHz
1 piece price shown. See web or call for volume pricing.	0.160" dia.	dB/100ft	W
8" 12" 18" 24"	30"	36"	Custom Len.
\$532.81 \$537.70 \$545.06 \$552.41	\$559.76	\$567.11	See Web

47

TNC FEMALE BULKHEAD TO TNC FEMALE BULKHEAD

SEE MOUNTING HOLE SECTION ON PAGE 369



Low Loss Flexible Cable Assemblies

PE-P142LL Coax, 50 Ohm

Part No. PE3C2180	Cable Dia.	Attn. @ 1 GHz	Power @ 1 GHz
1 piece price shown. See web or call for volume pricing.	0.195" dia.	10 dB/100ft	W
12" 24" 36" 48"	60"	50CM	Custom Len.
\$235.24 \$251.48 \$267.72 \$283.95	\$300.19	\$245.64	See Web

48

PE-P142LL-27478 Coax, 50 Ohm

Part No. PE3M0165	Cable Dia.	Attn. @ 1 GHz	Power @ 1 GHz
1 piece price shown. See web or call for volume pricing.	0.195" dia.	dB/100ft	W
12" 18" 24" 36"	48"	60"	Custom Len.
\$544.46 \$552.94 \$561.41 \$578.37	\$595.33	\$612.28	See Web

49

PE-P160LL-27478 Coax, 50 Ohm

Part No. PE3M0210	Cable Dia.	Attn. @ 1 GHz	Power @ 1 GHz
1 piece price shown. See web or call for volume pricing.	0.160" dia.	dB/100ft	W
8" 12" 18" 24"	30"	36"	Custom Len.
\$528.87 \$533.77 \$541.12 \$548.47	\$555.82	\$563.17	See Web

50

PE-P160LL Coax, 50 Ohm

Part No. PE3C5251	Cable Dia.	Attn. @ 1 GHz	Power @ 1 GHz
1 piece price shown. See web or call for volume pricing.	0.160" dia.	dB/100ft	W
12" 24" 36" 48"	60"	50CM	Custom Len.
\$258.01 \$278.73 \$299.44 \$320.15	\$340.86	\$271.28	See Web

51

TNC FEMALE BULKHEAD TO UMCX PLUG RIGHT ANGLE

SEE MOUNTING HOLE SECTION ON PAGE 369



Standard Flexible Cable Assemblies

RG178B/U Coax, 50 Ohm

Part No. PE38304	Cable Dia.	Attn. @ 1 GHz	Power @ 1 GHz
1 piece price shown. See web or call for volume pricing.	0.072" dia.	44 dB/100ft	78 W
3" 6" 9" 12"	18"	24"	Custom Len.
\$53.28 \$54.99 \$56.71 \$58.42	\$58.81	\$62.48	See Web

52

REVERSE POLARITY TNC FEMALE BULKHEAD TO MMCX PLUG

SEE MOUNTING HOLE SECTION ON PAGE 369



Low Loss Flexible Cable Assemblies

LMR-100A-PVC Coax, 50 Ohm

Part No. PE3W01379	Cable Dia.	Attn. @ 1 GHz	Power @ 1 GHz
1 piece price shown. See web or call for volume pricing.	0.110" dia.	dB/100ft	W
12" 24" 36" 48"	60"	50CM	Custom Len.
\$78.66 \$79.39 \$80.13 \$80.87	\$81.60	\$79.13	See Web

53

REVERSE POLARITY TNC FEMALE BULKHEAD TO SSMC PLUG RIGHT ANGLE

SEE MOUNTING HOLE SECTION ON PAGE 369



Standard Flexible Cable Assemblies

RG188A/U Coax, 50 Ohm

Part No. PE3W05762	Cable Dia.	Attn. @ 1 GHz	Power @ 1 GHz
1 piece price shown. See web or call for volume pricing.	0.110" dia.	26 dB/100ft	160 W
12" 24" 36" 48"	60"	50CM	Custom Len.
\$93.76 \$96.42 \$99.09 \$101.76	\$104.43	\$95.46	See Web

54

REVERSE POLARITY TNC FEMALE BULKHEAD TO REVERSE POLARITY TNC

SEE MOUNTING HOLE SECTION ON PAGE 369



Standard Formable Cable Assemblies

PE-SR402FLJ Coax, 50 Ohm

Part No. PE3W05610	Cable Dia.	Attn. @ 1 GHz	Power @ 1 GHz
1 piece price shown. See web or call for volume pricing.	0.161" dia.	12 dB/100ft	303 W
12" 24" 36" 48"	60"	50CM	Custom Len.
\$82.39 \$91.28 \$100.16 \$109.04	\$117.93	\$88.08	See Web

55

REVERSE POLARITY TNC FEMALE BULKHEAD TO UMCX PLUG

SEE MOUNTING HOLE SECTION ON PAGE 369



Standard Flexible Cable Assemblies

RG178B/U Coax, 50 Ohm

Part No. PE38303	Cable Dia.	Attn. @ 1 GHz	Power @ 1 GHz
1 piece price shown. See web or call for volume pricing.	0.072" dia.	dB/100ft	W
3" 6" 9" 12"	18"	24"	Custom Len.
\$53.56 \$53.56 \$53.56 \$55.70	\$57.24	\$60.92	See Web

56

UHF MALE TO BNC MALE



Low Loss Flexible Cable Assemblies

PE-C195 Coax, 50 Ohm

Part No. PE38674	Cable Dia.	Attn. @ 1 GHz	Power @ 1 GHz
1 piece price shown. See web or call for volume pricing.	0.195" dia.	11 dB/100ft	150 W
12" 24" 36" 48"	60"	-	Custom Len.
\$26.16 \$26.88 \$27.60 \$30.12	\$29.49	-	See Web

57

Standard Flexible Cable Assemblies

RG8A/U Coax, 50 Ohm

Part No. PE34581	Cable Dia.	Attn. @ 1 GHz	Power @ 1 GHz
1 piece price shown. See web or call for volume pricing.	0.405" dia.	8 dB/100ft	190 W
12" 24" 36" 48"	60"	72"	Custom Len.
\$63.83 \$66.58 \$73.80 \$72.03	\$74.74	\$77.50	See Web

58

RG58C/U Coax, 50 Ohm

Part No. PE3057	Cable Dia.	Attn. @ 1 GHz	Power @ 1 GHz
1 piece price shown. See web or call for volume pricing.	0.195" dia.	20 dB/100ft	44 W
12" 24" 36" 48"	60"	72"	Custom Len.
\$36.43 \$37.24 \$38.05 \$38.91	\$39.74	\$40.57	See Web

59

RG142B/U Coax, 50 Ohm

Part No. PE3898	Cable Dia.	Attn. @ 1 GHz	Power @ 1 GHz
1 piece price shown. See web or call for volume pricing.	0.195" dia.	13 dB/100ft	650 W
12" 24" 36" 48"	60"	72"	Custom Len.
\$35.42 \$41.14 \$46.88 \$52.61	\$58.34	\$64.08	See Web

60

RG213/U Coax, 50 Ohm

Part No. PE34583	Cable Dia.	Attn. @ 1 GHz	Power @ 1 GHz
1 piece price shown. See web or call for volume pricing.	0.405" dia.	8 dB/100ft	190 W
12" 24" 36" 48"	60"	72"	Custom Len.
\$66.50 \$68.17 \$69.82 \$71.49	\$73.15	\$74.82	See Web

61

RG214/U Coax, 50 Ohm

Part No. PE33438	Cable Dia.	Attn. @ 1 GHz	Power @ 1 GHz
1 piece price shown. See web or call for volume pricing.	0.425" dia.	7 dB/100ft	190 W
12" 24" 36" 48"	60"	72"	Custom Len.
\$65.98 \$73.36 \$80.74 \$93.73	\$95.52	\$102.88	See Web

62

RG223/U Coax, 50 Ohm

Part No. PE3803	Cable Dia.	Attn. @ 1 GHz	Power @ 1 GHz
1 piece price shown. See web or call for volume pricing.	0.210" dia.	13 dB/100ft	53 W
12" 24" 36" 48"	60"	72"	Custom Len.
\$32.63 \$35.53 \$38.43 \$41.33	\$44.23	\$47.13	See Web

63

RG225/U Coax, 50 Ohm

Part No. PE34589	Cable Dia.	Attn. @ 1 GHz	Power @ 1 GHz
1 piece price shown. See web or call for volume pricing.	0.430" dia.	dB/100ft	1700 W
12" 24" 36" 48"	60"	72"	Custom Len.
\$96.27 \$121.74 \$154.32 \$186.91	\$219.49	\$252.07	See Web

64

RG400/U Coax, 50 Ohm

Part No. PE3231	Cable Dia.	Attn. @ 1 GHz	Power @ 1 GHz
1 piece price shown. See web or call for volume pricing.	0.195" dia.	15 dB/100ft	600 W
12" 24" 36" 48"	60"	72"	Custom Len.
\$43.51 \$53.52 \$60.92 \$64.42	\$71.39	\$78.36	See Web

65

RG55B/U Coax, 53 Ohm

Part No. PE34591	Cable Dia.	Attn. @ 1 GHz	Power @ 1 GHz
1 piece price shown. See web or call for volume pricing.	0.202" dia.	17 dB/100ft	53 W
12" 24" 36" 48"	60"	72"	Custom Len.
\$31.78 \$34.02 \$36.26 \$38.51	\$40.75	\$42.98	See Web

66

RG59B/U Coax, 75 Ohm

Part No. PE3543	Cable Dia.	Attn. @ 1 GHz	Power @ 1 GHz
1 piece price shown. See web or call for volume pricing.	0.242" dia.	12 dB/100ft	77 W
12" 24" 36" 48"	60"	72"	Custom Len.
\$28.71 \$29.61 \$30.51 \$31.40	\$32.32	\$33.21	See Web

67

Cable Assemblies

See Our Website For Current Pricing & Real-Time Stock Availability!

For Custom Lengths, Metric Lengths or Special Configurations, Please call (949) 261-1920

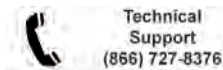









Technical Support
(866) 727-8376



Same-Day Shipping,
Even Custom
Cable Assemblies

For our complete selection of cable assemblies, please visit our website

RG62A/U Coax, 93 Ohm						
Part No. PE34587	Cable Dia.			Attn. @ 1 GHz	Power @ 1 GHz	
1 piece price shown. See web or call for volume pricing.						
12"	24"	36"	48"	60"	72"	Custom Len.
\$31.46	\$32.82	\$34.19	\$38.06	\$36.94	\$38.31	See Web
UHF MALE TO UHF MALE 						
Low Loss Flexible Cable Assemblies						
PE-C195 Coax, 50 Ohm						
Part No. PE38632	Cable Dia.			Attn. @ 1 GHz	Power @ 1 GHz	
1 piece price shown. See web or call for volume pricing.						
12"	24"	36"	48"	60"	-	Custom Len.
\$25.23	\$25.89	\$26.72	\$28.04	\$29.42	-	See Web
Standard Flexible Cable Assemblies						
RG8A/U Coax, 50 Ohm						
Part No. PE3623	Cable Dia.			Attn. @ 1 GHz	Power @ 1 GHz	
1 piece price shown. See web or call for volume pricing.						
12"	24"	36"	48"	60"	72"	Custom Len.
\$64.15	\$62.23	\$65.06	\$67.90	\$70.72	\$73.56	See Web
RG58C/U Coax, 50 Ohm						
Part No. PE3015	Cable Dia.			Attn. @ 1 GHz	Power @ 1 GHz	
1 piece price shown. See web or call for volume pricing.						
12"	24"	36"	48"	60"	72"	Custom Len.
\$37.11	\$37.93	\$38.74	\$39.61	\$40.44	\$41.26	See Web
RG142B/U Coax, 50 Ohm						
Part No. PE33053	Cable Dia.			Attn. @ 1 GHz	Power @ 1 GHz	
1 piece price shown. See web or call for volume pricing.						
12"	24"	36"	48"	60"	-	Custom Len.
\$37.12	\$43.20	\$49.28	\$52.22	\$57.96	-	See Web
RG213/U Coax, 50 Ohm						
Part No. PE3635	Cable Dia.			Attn. @ 1 GHz	Power @ 1 GHz	
1 piece price shown. See web or call for volume pricing.						
12"	24"	36"	48"	60"	72"	Custom Len.
\$57.24	\$58.89	\$60.55	\$62.22	\$63.88	\$65.54	See Web
RG214/U Coax, 50 Ohm						
Part No. PE3796	Cable Dia.			Attn. @ 1 GHz	Power @ 1 GHz	
1 piece price shown. See web or call for volume pricing.						
12"	24"	36"	48"	60"	72"	Custom Len.
\$68.31	\$70.58	\$85.23	\$92.56	\$107.97	-	See Web
RG223/U Coax, 50 Ohm						
Part No. PE3845	Cable Dia.			Attn. @ 1 GHz	Power @ 1 GHz	
1 piece price shown. See web or call for volume pricing.						
12"	24"	36"	48"	60"	72"	Custom Len.
\$31.53	\$34.43	\$37.33	\$40.24	\$43.13	\$46.03	See Web
RG393/U Coax, 50 Ohm						
Part No. PE33267	Cable Dia.			Attn. @ 1 GHz	Power @ 1 GHz	
1 piece price shown. See web or call for volume pricing.						
12"	24"	36"	48"	60"	72"	Custom Len.
\$71.72	\$83.13	\$104.53	\$114.06	\$129.53	\$144.99	See Web
RG400/U Coax, 50 Ohm						
Part No. PE3743	Cable Dia.			Attn. @ 1 GHz	Power @ 1 GHz	
1 piece price shown. See web or call for volume pricing.						
12"	24"	36"	48"	60"	-	Custom Len.
\$41.63	\$48.60	\$55.58	\$62.54	\$69.51	-	See Web
RG59B/U Coax, 75 Ohm						
Part No. PE3580	Cable Dia.			Attn. @ 1 GHz	Power @ 1 GHz	
1 piece price shown. See web or call for volume pricing.						
12"	24"	36"	48"	60"	72"	Custom Len.
\$28.12	\$29.01	\$29.91	\$33.54	\$31.70	\$32.62	See Web
HMCX32 1.2 PLUG TO HMCX32 1.2 PLUG 						
Standard Flexible Cable Assemblies						
PE-81mm Coax, 50 Ohm						
Part No. PE3CA1058	Cable Dia.			Attn. @ 1 GHz	Power @ 1 GHz	
1 piece price shown. See web or call for volume pricing.						
6"	9"	12"	-	-	-	Custom Len.
\$10.04	\$10.80	\$11.57	-	-	-	See Web
UMCX PLUG RIGHT ANGLE TO MCX PLUG 						
Standard Flexible Cable Assemblies						
RG178B/U Coax, 50 Ohm						
Part No. PE38890	Cable Dia.			Attn. @ 1 GHz	Power @ 1 GHz	
1 piece price shown. See web or call for volume pricing.						
3"	6"	9"	12"	18"	24"	Custom Len.
\$62.00	\$63.52	\$62.00	\$66.95	\$65.66	\$69.35	See Web

UMCX PLUG RIGHT ANGLE TO MCX PLUG RIGHT ANGLE 						
Standard Flexible Cable Assemblies						
RG178B/U Coax, 50 Ohm						
Part No. PE38502	Cable Dia.			Attn. @ 1 GHz	Power @ 1 GHz	
1 piece price shown. See web or call for volume pricing.						
3"	6"	9"	12"	18"	24"	Custom Len.
\$57.29	\$58.44	\$57.29	\$57.29	\$60.97	\$64.65	See Web
UMCX PLUG RIGHT ANGLE TO MCX JACK BULKHEAD 						
SEE MOUNTING HOLE SECTION ON PAGE 369						
Standard Flexible Cable Assemblies						
RG178B/U Coax, 50 Ohm						
Part No. PE38889	Cable Dia.			Attn. @ 1 GHz	Power @ 1 GHz	
1 piece price shown. See web or call for volume pricing.						
3"	6"	9"	12"	18"	24"	Custom Len.
\$72.93	\$72.93	\$72.93	\$78.77	\$76.62	\$80.29	See Web
PE-113mm Coax, 50 Ohm						
Part No. PE38298	Cable Dia.			Attn. @ 1 GHz	Power @ 1 GHz	
1 piece price shown. See web or call for volume pricing.						
6"	12"	-	-	-	-	Custom Len.
\$23.38	\$22.77	-	-	-	-	See Web
UMCX PLUG RIGHT ANGLE TO MMCX PLUG RIGHT ANGLE 						
Standard Flexible Cable Assemblies						
RG178B/U Coax, 50 Ohm						
Part No. PE39078	Cable Dia.			Attn. @ 1 GHz	Power @ 1 GHz	
1 piece price shown. See web or call for volume pricing.						
3"	6"	9"	12"	18"	24"	Custom Len.
\$62.85	\$64.56	\$66.28	\$67.99	\$71.52	\$75.06	See Web
UMCX 2.1 PLUG TO UMCX 2.1 PLUG 						
Standard Flexible Cable Assemblies						
PE-81mm Coax, 50 Ohm						
Part No. PE3CA1056	Cable Dia.			Attn. @ 1 GHz	Power @ 1 GHz	
1 piece price shown. See web or call for volume pricing.						
6"	9"	12"	-	-	-	Custom Len.
\$7.97	\$9.70	\$10.47	-	-	-	See Web
UMCX 2.5 PLUG TO UMCX 2.5 PLUG 						
Standard Flexible Cable Assemblies						
RG178B/U Coax, 50 Ohm						
Part No. PE3CA1054	Cable Dia.			Attn. @ 1 GHz	Power @ 1 GHz	
1 piece price shown. See web or call for volume pricing.						
6"	9"	12"	-	-	-	Custom Len.
\$10.25	\$11.70	\$12.88	-	-	-	See Web
RG178-DS Coax, 50 Ohm						
Part No. PE3CA1055	Cable Dia.			Attn. @ 1 GHz	Power @ 1 GHz	
1 piece price shown. See web or call for volume pricing.						
6"	9"	12"	-	-	-	Custom Len.
\$10.71	\$12.88	\$16.57	-	-	-	See Web
PE-113mm Coax, 50 Ohm						
Part No. PE3CA1052	Cable Dia.			Attn. @ 1 GHz	Power @ 1 GHz	
1 piece price shown. See web or call for volume pricing.						
6"	9"	12"	-	-	-	Custom Len.
\$8.78	\$8.67	\$10.47	-	-	-	See Web
PE-137mm Coax, 50 Ohm						
Part No. PE3CA1053	Cable Dia.			Attn. @ 1 GHz	Power @ 1 GHz	
1 piece price shown. See web or call for volume pricing.						
6"	9"	12"	-	-	-	Custom Len.
\$9.16	\$10.04	\$10.92	-	-	-	See Web
WMCX 1.6 PLUG TO WMCX 1.6 PLUG 						
Standard Flexible Cable Assemblies						
PE-81mm Coax, 50 Ohm						
Part No. PE3CA1057	Cable Dia.			Attn. @ 1 GHz	Power @ 1 GHz	
1 piece price shown. See web or call for volume pricing.						
6"	9"	12"	-	-	-	Custom Len.
\$8.47	\$9.15	\$11.04	-	-	-	See Web

Cable Assemblies

See Our Website For Current Pricing & Real-Time Stock Availability!

*Coax Performance at 1 GHz Notes: Cable assembly max frequency may be lower than connector or coax max frequency

For our complete selection of cable assemblies, please visit our website

2.92MM NMD FEMALE TO 2.92MM MALE



Standard Flexible Cable Assemblies

PE-VNA-R Coax, 50 Ohm

Part No. PE3VNA4007	Cable Dia.	Attn. @ 1 GHz	Power @ 1 GHz
1 piece price shown. See web or call for volume pricing.			
24"	0.430" dia.	dB/100ft	W
36"	-	-	-
48"	-	-	-
60"	-	-	-
\$2,266.15	\$2,373.30	\$2,477.20	See Web

91

2.92MM NMD FEMALE TO 2.92MM FEMALE



Standard Flexible Cable Assemblies

PE-VNA-R Coax, 50 Ohm

Part No. PE3VNA4008	Cable Dia.	Attn. @ 1 GHz	Power @ 1 GHz
1 piece price shown. See web or call for volume pricing.			
24"	0.430" dia.	dB/100ft	W
36"	-	-	-
48"	-	-	-
60"	-	-	-
\$2,331.09	\$2,438.24	\$2,538.89	See Web

92

MCX PLUG TO 75 OHM BNC MALE



Standard Flexible Cable Assemblies

RG187A/U Coax, 75 Ohm

Part No. PE3C5491	Cable Dia.	Attn. @ 1 GHz	Power @ 1 GHz
1 piece price shown. See web or call for volume pricing.			
12"	0.102" dia.	25 dB/100ft	200 W
24"	60"	50CM	Custom Len.
36"	-	-	-
48"	-	-	-
\$44.20	\$47.91	\$51.62	\$55.33
\$59.04	\$46.58	See Web	

93

BNC MALE TO NMO MOUNT SEXLESS



Standard Flexible Cable Assemblies

RG58C/U Coax, 50 Ohm

Part No. PE37844	Cable Dia.	Attn. @ 1 GHz	Power @ 1 GHz
1 piece price shown. See web or call for volume pricing.			
60"	0.195" dia.	20 dB/100ft	44 W
120"	-	-	-
180"	-	-	-
\$42.45	\$50.14	\$49.81	See Web

94

BNC MALE TO CUT LEAD SEXLESS



Standard Flexible Cable Assemblies

RG188A/U Coax, 50 Ohm

Part No. PE3C3583	Cable Dia.	Attn. @ 1 GHz	Power @ 1 GHz
1 piece price shown. See web or call for volume pricing.			
12"	0.110" dia.	26 dB/100ft	160 W
24"	60"	39.37"	Custom Len.
36"	-	-	-
48"	-	-	-
\$23.15	\$25.57	\$27.99	\$30.41
\$32.83	Call	See Web	

95

BNC FEMALE TO NMO MOUNT SEXLESS



Standard Flexible Cable Assemblies

RG58C/U Coax, 50 Ohm

Part No. PE37845	Cable Dia.	Attn. @ 1 GHz	Power @ 1 GHz
1 piece price shown. See web or call for volume pricing.			
60"	0.195" dia.	20 dB/100ft	44 W
120"	-	-	-
180"	-	-	-
\$41.37	\$45.04	\$48.69	See Web

96

MINI UHF MALE TO NMO MOUNT SEXLESS



Standard Flexible Cable Assemblies

RG58C/U Coax, 50 Ohm

Part No. PE37846	Cable Dia.	Attn. @ 1 GHz	Power @ 1 GHz
1 piece price shown. See web or call for volume pricing.			
60"	0.195" dia.	20 dB/100ft	44 W
120"	-	-	-
180"	-	-	-
\$41.30	\$44.98	\$48.66	See Web

97

N MALE TO NMO MOUNT SEXLESS



Standard Flexible Cable Assemblies

RG58C/U Coax, 50 Ohm

Part No. PE37850	Cable Dia.	Attn. @ 1 GHz	Power @ 1 GHz
1 piece price shown. See web or call for volume pricing.			
60"	0.195" dia.	20 dB/100ft	44 W
120"	-	-	-
180"	-	-	-
\$52.39	\$56.53	\$60.68	See Web

98

N FEMALE TO NMO MOUNT SEXLESS



Standard Flexible Cable Assemblies

RG58C/U Coax, 50 Ohm

Part No. PE37851	Cable Dia.	Attn. @ 1 GHz	Power @ 1 GHz
1 piece price shown. See web or call for volume pricing.			
60"	0.195" dia.	20 dB/100ft	44 W
120"	-	-	-
180"	-	-	-
\$47.98	\$51.63	\$60.26	See Web

99

SMA MALE TO NMO MOUNT SEXLESS



Standard Flexible Cable Assemblies

RG58C/U Coax, 50 Ohm

Part No. PE37840	Cable Dia.	Attn. @ 1 GHz	Power @ 1 GHz
1 piece price shown. See web or call for volume pricing.			
60"	0.195" dia.	20 dB/100ft	44 W
120"	-	-	-
180"	-	-	-
\$51.10	\$50.87	\$59.39	See Web

1

SMA FEMALE TO NMO MOUNT SEXLESS



Standard Flexible Cable Assemblies

RG58C/U Coax, 50 Ohm

Part No. PE37841	Cable Dia.	Attn. @ 1 GHz	Power @ 1 GHz
1 piece price shown. See web or call for volume pricing.			
60"	0.195" dia.	20 dB/100ft	44 W
120"	-	-	-
180"	-	-	-
\$60.05	\$59.16	\$62.84	See Web

2

SMA FEMALE TO TRIMMED LEAD SEXLESS



Standard Semi-Rigid Cable Assemblies

PE-020SR Coax, 50 Ohm

Part No. PE3CA1104	Cable Dia.	Attn. @ 1 GHz	Power @ 1 GHz
1 piece price shown. See web or call for volume pricing.			
3"	0.020" dia.	dB/100ft	W
6"	-	-	-
9"	-	-	-
12"	-	-	-
\$95.25	\$112.74	\$130.25	\$147.75
			See Web

3

PE-034SR Coax, 50 Ohm

Part No. PE3CA1105	Cable Dia.	Attn. @ 1 GHz	Power @ 1 GHz
1 piece price shown. See web or call for volume pricing.			
3"	0.034" dia.	dB/100ft	W
6"	5.9"	-	Custom Len.
9"	-	-	-
12"	-	-	-
\$35.59	\$42.13	\$48.68	\$55.22
	Call	See Web	

4

PE-SR047TN Coax, 50 Ohm

Part No. PE3CA1106	Cable Dia.	Attn. @ 1 GHz	Power @ 1 GHz
1 piece price shown. See web or call for volume pricing.			
3"	0.047" dia.	dB/100ft	W
6"	-	-	-
9"	-	-	-
12"	-	-	-
\$38.17	\$41.95	\$47.20	\$52.43
			See Web

5

SMA FEMALE TO CUT LEAD SEXLESS



Standard Semi-Rigid Cable Assemblies

PE-020SR Coax, 50 Ohm

Part No. PE3CA1107	Cable Dia.	Attn. @ 1 GHz	Power @ 1 GHz
1 piece price shown. See web or call for volume pricing.			
3"	0.020" dia.	dB/100ft	W
6"	-	-	-
9"	-	-	-
12"	-	-	-
\$61.56	\$80.37	\$99.17	\$117.98
			See Web

6

PE-034SR Coax, 50 Ohm

Part No. PE3CA1102	Cable Dia.	Attn. @ 1 GHz	Power @ 1 GHz
1 piece price shown. See web or call for volume pricing.			
3"	0.034" dia.	dB/100ft	W
6"	5.9"	-	Custom Len.
9"	-	-	-
12"	-	-	-
\$31.34	\$36.59	\$41.87	\$47.17
			See Web

7

PE-047SR Coax, 50 Ohm

Part No. PE3CA1103	Cable Dia.	Attn. @ 1 GHz	Power @ 1 GHz
1 piece price shown. See web or call for volume pricing.			
3"	0.047" dia.	dB/100ft	W
6"	-	-	-
9"	-	-	-
12"	-	-	-
\$31.15	\$36.42	\$41.68	\$46.99
			See Web

8

TNC FEMALE TO NMO MOUNT SEXLESS



Standard Flexible Cable Assemblies

RG58C/U Coax, 50 Ohm

Part No. PE37849	Cable Dia.	Attn. @ 1 GHz	Power @ 1 GHz
1 piece price shown. See web or call for volume pricing.			
60"	0.195" dia.	20 dB/100ft	44 W
120"	-	-	-
180"	-	-	-
\$49.73	\$53.41	\$57.09	See Web

9

Cable Assemblies

See Our Website For Current Pricing & Real-Time Stock Availability!

For Custom Lengths, Metric Lengths or Special Configurations, Please call (949) 261-1920



Technical Support
(866) 727-8376

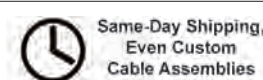

Same-Day Shipping,
Even Custom Cable Assemblies

For our complete selection of cable assemblies, please visit our website

75 OHM 1.6/5.6 PLUG TO
75 OHM 1.6/5.6 PLUG



Standard Flexible Cable Assemblies

RG59B/U Coax, 75 Ohm

Part No. PE36109	Cable Dia.	Attn. @ 1 GHz	Power @ 1 GHz
1 piece price shown. See web or call for volume pricing.			
12"	0.242" dia.	12 dB/100ft	77 W
24"	60"	72"	Custom Len.
\$40.59	\$41.48	\$42.39	\$43.30 \$44.20 \$45.09 See Web

RG187A/U Coax, 75 Ohm

Part No. PE36113	Cable Dia.	Attn. @ 1 GHz	Power @ 1 GHz
1 piece price shown. See web or call for volume pricing.			
12"	0.110" dia.	25 dB/100ft	200 W
24"	60"	72"	Custom Len.
\$50.57	\$59.44	\$67.09	\$60.41 \$63.70 \$67.01 See Web

75 OHM 1.6/5.6 PLUG TO
75 OHM BNC MALE



Standard Flexible Cable Assemblies

RG59B/U Coax, 75 Ohm

Part No. PE36127	Cable Dia.	Attn. @ 1 GHz	Power @ 1 GHz
1 piece price shown. See web or call for volume pricing.			
12"	0.242" dia.	12 dB/100ft	77 W
24"	60"	72"	Custom Len.
\$39.95	\$44.19	\$41.87	\$42.84 \$43.78 \$44.75 See Web

75 OHM BNC MALE TO
75 OHM BNC MALE



Standard Flexible Cable Assemblies

RG6A/U Coax, 75 Ohm

Part No. PE33197	Cable Dia.	Attn. @ 1 GHz	Power @ 1 GHz
1 piece price shown. See web or call for volume pricing.			
12"	0.332" dia.	11 dB/100ft	100 W
24"	60"	72"	Custom Len.
\$43.94	\$45.33	\$50.92	\$50.69 \$58.16 \$61.73 See Web

RG6-CATV Coax, 75 Ohm

Part No. PE37808	Cable Dia.	Attn. @ 1 GHz	Power @ 1 GHz
1 piece price shown. See web or call for volume pricing.			
12"	0.275" dia.	7 dB/100ft	7 W
24"	60"	-	Custom Len.
\$57.78	\$58.97	\$60.18	\$61.45 \$57.65 - See Web

RG11A/U Coax, 75 Ohm

Part No. PE33399	Cable Dia.	Attn. @ 1 GHz	Power @ 1 GHz
1 piece price shown. See web or call for volume pricing.			
12"	0.405" dia.	4 dB/100ft	150 W
24"	60"	72"	Custom Len.
\$67.70	\$69.42	\$71.13	\$72.85 \$74.57 \$76.28 See Web

RG59B/U Coax, 75 Ohm

Part No. PE33188	Cable Dia.	Attn. @ 1 GHz	Power @ 1 GHz
1 piece price shown. See web or call for volume pricing.			
12"	0.242" dia.	12 dB/100ft	77 W
24"	60"	72"	Custom Len.
\$39.74	\$40.78	\$41.82	\$42.92 \$43.98 \$45.03 See Web

RG179B/U Coax, 75 Ohm

Part No. PE33401	Cable Dia.	Attn. @ 1 GHz	Power @ 1 GHz
1 piece price shown. See web or call for volume pricing.			
12"	0.100" dia.	25 dB/100ft	200 W
24"	60"	72"	Custom Len.
\$49.71	\$52.26	\$54.82	\$57.53 \$60.14 \$62.75 See Web

PE-B150 Coax, 75 Ohm

Part No. PE33405	Cable Dia.	Attn. @ 1 GHz	Power @ 1 GHz
1 piece price shown. See web or call for volume pricing.			
12"	0.150" dia.	20 dB/100ft	25 W
24"	60"	72"	Custom Len.
\$57.01	\$62.50	\$63.41	\$59.39 \$60.18 \$60.97 See Web

75 OHM BNC MALE TO
75 OHM BNC MALE RIGHT ANGLE



Standard Flexible Cable Assemblies

RG6A/U Coax, 75 Ohm

Part No. PE33407	Cable Dia.	Attn. @ 1 GHz	Power @ 1 GHz
1 piece price shown. See web or call for volume pricing.			
12"	0.332" dia.	11 dB/100ft	125 W
24"	60"	72"	Custom Len.
\$67.51	\$70.21	\$72.88	\$75.56 \$78.23 \$80.90 See Web

RG59B/U Coax, 75 Ohm

Part No. PE33196	Cable Dia.	Attn. @ 1 GHz	Power @ 1 GHz
1 piece price shown. See web or call for volume pricing.			
12"	0.242" dia.	12 dB/100ft	77 W
24"	60"	72"	Custom Len.
\$55.25	\$56.22	\$61.75	\$58.13 \$59.10 \$60.04 See Web

Part No. PE3W00288	Cable Dia.	Attn. @ 1 GHz	Power @ 1 GHz
1 piece price shown. See web or call for volume pricing.			
12"	0.242" dia.	dB/100ft	77 W
24"	60"	50CM	Custom Len.
\$71.03	\$72.03	\$73.04	\$74.05 \$75.06 \$71.67 See Web

RG179B/U Coax, 75 Ohm

Part No. PE33412	Cable Dia.	Attn. @ 1 GHz	Power @ 1 GHz
1 piece price shown. See web or call for volume pricing.			
12"	0.100" dia.	25 dB/100ft	200 W
24"	60"	72"	Custom Len.
\$61.17	\$63.73	\$63.55	\$68.99 \$68.26 \$70.64 See Web

RG187A/U Coax, 75 Ohm

Part No. PE33414	Cable Dia.	Attn. @ 1 GHz	Power @ 1 GHz
1 piece price shown. See web or call for volume pricing.			
12"	0.110" dia.	25 dB/100ft	200 W
24"	60"	72"	Custom Len.
\$62.28	\$66.10	\$69.92	\$68.96 \$72.36 \$75.75 See Web

75 OHM BNC MALE TO
75 OHM BNC FEMALE



Standard Flexible Cable Assemblies

RG6A/U Coax, 75 Ohm

Part No. PE33437	Cable Dia.	Attn. @ 1 GHz	Power @ 1 GHz
1 piece price shown. See web or call for volume pricing.			
12"	0.332" dia.	11 dB/100ft	125 W
24"	60"	72"	Custom Len.
\$78.67	\$81.34	\$84.01	\$86.69 \$97.62 \$92.06 See Web

RG59B/U Coax, 75 Ohm

Part No. PE33441	Cable Dia.	Attn. @ 1 GHz	Power @ 1 GHz
1 piece price shown. See web or call for volume pricing.			
12"	0.242" dia.	12 dB/100ft	77 W
24"	60"	72"	Custom Len.
\$44.37	\$45.32	\$49.99	\$47.24 \$48.19 \$49.16 See Web

RG179B/U Coax, 75 Ohm

Part No. PE33443	Cable Dia.	Attn. @ 1 GHz	Power @ 1 GHz
1 piece price shown. See web or call for volume pricing.			
12"	0.100" dia.	25 dB/100ft	200 W
24"	60"	72"	Custom Len.
\$52.91	\$58.64	\$57.63	\$60.00 \$62.36 \$69.11 See Web

75 OHM BNC MALE TO
75 OHM BNC FEMALE BULKHEAD
SEE MOUNTING HOLE SECTION ON PAGE 369



Standard Flexible Cable Assemblies

RG6A/U Coax, 75 Ohm

Part No. PE33417	Cable Dia.	Attn. @ 1 GHz	Power @ 1 GHz
1 piece price shown. See web or call for volume pricing.			
12"	0.332" dia.	11 dB/100ft	125 W
24"	60"	72"	Custom Len.
\$85.26	\$87.94	\$90.62	\$93.29 \$95.97 \$98.64 See Web

RG59B/U Coax, 75 Ohm

Part No. PE33179	Cable Dia.	Attn. @ 1 GHz	Power @ 1 GHz
1 piece price shown. See web or call for volume pricing.			
12"	0.242" dia.	12 dB/100ft	77 W
24"	60"	72"	Custom Len.
\$59.72	\$60.75	\$56.21	\$57.17 \$68.13 \$59.09 See Web

RG179B/U Coax, 75 Ohm

Part No. PE33421	Cable Dia.	Attn. @ 1 GHz	Power @ 1 GHz
1 piece price shown. See web or call for volume pricing.			
12"	0.100" dia.	25 dB/100ft	200 W
24"	60"	72"	Custom Len.
\$61.77	\$64.33	\$61.93	\$64.29 \$66.65 \$69.02 See Web

PE-B150 Coax, 75 Ohm

Part No. PE33425	Cable Dia.	Attn. @ 1 GHz	Power @ 1 GHz
1 piece price shown. See web or call for volume pricing.			
12"	0.150" dia.	20 dB/100ft	25 W
24"	60"	72"	Custom Len.
\$69.01	\$69.80	\$70.59	\$71.38 \$72.17 \$72.98 See Web

75 OHM BNC MALE RIGHT ANGLE TO
75 OHM BNC MALE RIGHT ANGLE



Standard Flexible Cable Assemblies

RG59B/U Coax, 75 Ohm

Part No. PE33430	Cable Dia.	Attn. @ 1 GHz	Power @ 1 GHz
1 piece price shown. See web or call for volume pricing.			
12"	0.242" dia.	12 dB/100ft	77 W
24"	60"	72"	Custom Len.
\$74.43	\$75.39	\$82.47	\$77.30 \$78.27 \$79.23 See Web

RG179B/U Coax, 75 Ohm

Part No. PE33432	Cable Dia.	Attn. @ 1 GHz	Power @ 1 GHz
1 piece price shown. See web or call for volume pricing.			
12"	0.100" dia.	29 dB/100ft	W
24"	60"	72"	Custom Len.
\$68.61	\$70.96	\$73.33	\$75.69 \$78.06 \$80.42 See Web

RG187A/U Coax, 75 Ohm

Part No. PE33434	Cable Dia.	Attn. @ 1 GHz	Power @ 1 GHz
1 piece price shown. See web or call for volume pricing.			
12"	0.110" dia.	25 dB/100ft	200 W
24"	60"	72"	Custom Len.
\$69.56	\$72.97	\$81.37	\$79.77 \$83.17 \$86.57 See Web

75 OHM BNC FEMALE TO
75 OHM BNC FEMALE



Standard Flexible Cable Assemblies

RG6A/U Coax, 75 Ohm

Cable Assemblies See Our Website For Current Pricing & Real-Time Stock Availability!

*Coax Performance at 1 GHz Notes: Cable assembly max frequency may be lower than connector or coax max frequency

For our complete selection of cable assemblies, please visit our website

Part No. PE33448		Cable Dia.	Attn. @ 1 GHz	Power @ 1 GHz	34		
1 piece price shown. See web or call for volume pricing.		0.332" dia.	11 dB/100ft	125 W			
12"	24"	36"	48"	60"		72"	Custom Len.
\$101.39	\$103.24	\$105.05	\$106.90	\$108.70		\$110.57	See Web
RG59B/U Coax, 75 Ohm							
Part No. PE33452		Cable Dia.	Attn. @ 1 GHz	Power @ 1 GHz	35		
1 piece price shown. See web or call for volume pricing.		0.242" dia.	12 dB/100ft	77 W			
12"	24"	36"	48"	60"		72"	Custom Len.
\$48.82	\$49.71	\$50.62	\$51.51	\$52.42		\$53.31	See Web
RG179B/U Coax, 75 Ohm							
Part No. PE33451		Cable Dia.	Attn. @ 1 GHz	Power @ 1 GHz	36		
1 piece price shown. See web or call for volume pricing.		0.100" dia.	25 dB/100ft	200 W			
12"	24"	36"	48"	60"		72"	Custom Len.
\$53.69	\$56.07	\$58.47	\$60.81	\$63.22		\$69.95	See Web
RG187A/U Coax, 75 Ohm							
Part No. PE33456		Cable Dia.	Attn. @ 1 GHz	Power @ 1 GHz	37		
1 piece price shown. See web or call for volume pricing.		0.110" dia.	25 dB/100ft	200 W			
12"	24"	36"	48"	60"		72"	Custom Len.
\$54.64	\$57.87	\$61.19	\$64.48	\$67.77		\$71.08	See Web
75 OHM BNC FEMALE BULKHEAD TO 75 OHM BNC FEMALE BULKHEAD							
SEE MOUNTING HOLE SECTION ON PAGE 369							
Flexible Cable Assemblies							
RG187A/U Coax, 75 Ohm							
Part No. PE3W07034		Cable Dia.	Attn. @ 1 GHz	Power @ 1 GHz	38		
1 piece price shown. See web or call for volume pricing.		0.102" dia.	25 dB/100ft	200 W			
12"	24"	36"	48"	60"		50CM	Custom Len.
\$66.81	\$70.97	\$73.00	\$77.21	\$81.37		\$67.39	See Web
Standard Flexible Cable Assemblies							
RG62A/U Coax, 93 Ohm							
Part No. PE3W06444		Cable Dia.	Attn. @ 1 GHz	Power @ 1 GHz	39		
1 piece price shown. See web or call for volume pricing.		0.239" dia.	9 dB/100ft	77 W			
12"	24"	36"	48"	60"		50CM	Custom Len.
\$67.33	\$69.63	\$71.95	\$74.27	\$76.58		\$68.80	See Web
75 OHM F MALE TO 75 OHM BNC MALE							
Standard Flexible Cable Assemblies							
RG6-CATV Coax, 75 Ohm							
Part No. PE36145		Cable Dia.	Attn. @ 1 GHz	Power @ 1 GHz	40		
1 piece price shown. See web or call for volume pricing.		0.275" dia.	7 dB/100ft	7 W			
12"	24"	36"	48"	60"		72"	Custom Len.
\$32.81	\$34.01	\$33.03	\$36.48	\$37.69		\$36.14	See Web
RG11A/U Coax, 75 Ohm							
Part No. PE36147		Cable Dia.	Attn. @ 1 GHz	Power @ 1 GHz	41		
1 piece price shown. See web or call for volume pricing.		0.405" dia.	dB/100ft	150 W			
12"	24"	36"	48"	60"		72"	Custom Len.
\$53.30	\$55.03	\$56.74	\$58.45	\$60.18		\$61.89	See Web
RG59B/U Coax, 75 Ohm							
Part No. PE36149		Cable Dia.	Attn. @ 1 GHz	Power @ 1 GHz	42		
1 piece price shown. See web or call for volume pricing.		0.242" dia.	12 dB/100ft	77 W			
12"	24"	36"	48"	60"		72"	Custom Len.
\$28.84	\$27.66	\$30.91	\$32.01	\$33.07		\$31.50	See Web
RG179B/U Coax, 75 Ohm							
Part No. PE36153		Cable Dia.	Attn. @ 1 GHz	Power @ 1 GHz	43		
1 piece price shown. See web or call for volume pricing.		0.100" dia.	29 dB/100ft	W			
12"	24"	36"	48"	60"		72"	Custom Len.
\$39.46	\$42.03	\$44.58	\$43.65	\$46.01		\$48.37	See Web
RG187A/U Coax, 75 Ohm							
Part No. PE36155		Cable Dia.	Attn. @ 1 GHz	Power @ 1 GHz	44		
1 piece price shown. See web or call for volume pricing.		0.110" dia.	25 dB/100ft	200 W			
12"	24"	36"	48"	60"		72"	Custom Len.
\$42.53	\$42.78	\$46.18	\$49.59	\$52.99		\$56.39	See Web
75 OHM F MALE TO 75 OHM F MALE							
Low Loss Flexible Cable Assemblies							
PE-SF200LL75 Coax, 75 Ohm							
Part No. PE3TC1202		Cable Dia.	Attn. @ 1 GHz	Power @ 1 GHz	45		
1 piece price shown. See web or call for volume pricing.		0.195" dia.	dB/100ft	W			
24"	36"	48"	72"	100CM		200CM	Custom Len.
\$85.89	\$97.15	\$108.41	\$130.92	\$100.32		\$137.25	See Web
Standard Flexible Cable Assemblies							
RG6A/U Coax, 75 Ohm							
Part No. PE37163		Cable Dia.	Attn. @ 1 GHz	Power @ 1 GHz	46		
1 piece price shown. See web or call for volume pricing.		0.332" dia.	11 dB/100ft	125 W			
12"	24"	36"	48"	60"		-	Custom Len.
\$16.46	\$20.94	\$24.43	\$28.12	\$31.67		-	See Web
RG6-CATV Coax, 75 Ohm							

Part No. PE36132		Cable Dia.	Attn. @ 1 GHz	Power @ 1 GHz	47		
1 piece price shown. See web or call for volume pricing.		0.275" dia.	7 dB/100ft	7 W			
12"	24"	36"	48"	60"		72"	Custom Len.
\$18.88	\$20.07	\$21.28	\$22.55	\$23.76		\$24.99	See Web
RG11A/U Coax, 75 Ohm							
Part No. PE36135		Cable Dia.	Attn. @ 1 GHz	Power @ 1 GHz	48		
1 piece price shown. See web or call for volume pricing.		0.405" dia.	dB/100ft	150 W			
12"	24"	36"	48"	60"		72"	Custom Len.
\$39.63	\$41.35	\$46.13	\$44.78	\$46.51		\$48.22	See Web
RG59B/U Coax, 75 Ohm							
Part No. PE36141		Cable Dia.	Attn. @ 1 GHz	Power @ 1 GHz	49		
1 piece price shown. See web or call for volume pricing.		0.242" dia.	12 dB/100ft	77 W			
12"	24"	36"	48"	60"		72"	Custom Len.
\$16.39	\$17.42	\$18.46	\$19.56	\$19.30		\$20.26	See Web
RG59-WHITE Coax, 75 Ohm							
Part No. PE36143		Cable Dia.	Attn. @ 1 GHz	Power @ 1 GHz	50		
1 piece price shown. See web or call for volume pricing.		0.242" dia.	8 dB/100ft	200 W			
12"	24"	36"	48"	60"		72"	Custom Len.
\$16.23	\$18.21	\$20.18	\$22.16	\$24.15		\$26.07	See Web
RG179B/U Coax, 75 Ohm							
Part No. PE36137		Cable Dia.	Attn. @ 1 GHz	Power @ 1 GHz	51		
1 piece price shown. See web or call for volume pricing.		0.100" dia.	25 dB/100ft	200 W			
12"	24"	36"	48"	60"		72"	Custom Len.
\$27.10	\$27.88	\$32.21	\$32.68	\$35.01		\$37.41	See Web
RG187A/U Coax, 75 Ohm							
Part No. PE36139		Cable Dia.	Attn. @ 1 GHz	Power @ 1 GHz	52		
1 piece price shown. See web or call for volume pricing.		0.110" dia.	25 dB/100ft	200 W			
12"	24"	36"	48"	60"		72"	Custom Len.
\$27.97	\$28.62	\$31.80	\$34.90	\$38.09		\$41.26	See Web
75 OHM F MALE TO 75 OHM F MALE RIGHT ANGLE							
Standard Flexible Cable Assemblies							
RG59B/U Coax, 75 Ohm							
Part No. PE38343		Cable Dia.	Attn. @ 1 GHz	Power @ 1 GHz	53		
1 piece price shown. See web or call for volume pricing.		0.242" dia.	12 dB/100ft	77 W			
12"	24"	36"	48"	60"		-	Custom Len.
\$21.15	\$24.31	\$23.07	\$24.03	\$24.98		-	See Web
75 OHM F MALE TO 75 OHM F FEMALE							
Low Loss Flexible Cable Assemblies							
PE-SF200LL75 Coax, 75 Ohm							
Part No. PE3TC1203		Cable Dia.	Attn. @ 1 GHz	Power @ 1 GHz	54		
1 piece price shown. See web or call for volume pricing.		0.195" dia.	dB/100ft	W			
24"	36"	48"	72"	100CM		200CM	Custom Len.
\$85.89	\$97.15	\$108.41	\$130.92	\$100.32		\$137.25	See Web
75 OHM F MALE TO 75 OHM F FEMALE BULKHEAD							
SEE MOUNTING HOLE SECTION ON PAGE 369							
Standard Flexible Cable Assemblies							
RG179B/U Coax, 75 Ohm							
Part No. PE3C5570		Cable Dia.	Attn. @ 1 GHz	Power @ 1 GHz	55		
1 piece price shown. See web or call for volume pricing.		0.100" dia.	25 dB/100ft	W			
12"	24"	36"	48"	60"		-	Custom Len.
\$26.90	\$29.27	\$31.63	\$33.99	\$36.37		-	See Web
75 OHM MINI SMB PLUG TO 75 OHM BNC MALE							
Standard Flexible Cable Assemblies							
RG59B/U Coax, 75 Ohm							
Part No. PE34701		Cable Dia.	Attn. @ 1 GHz	Power @ 1 GHz	56		
1 piece price shown. See web or call for volume pricing.		0.242" dia.	12 dB/100ft	77 W			
12"	24"	36"	48"	60"		72"	Custom Len.
\$47.50	\$48.54	\$46.73	\$47.68	\$51.73		\$49.61	See Web
RG179B/U Coax, 75 Ohm							
Part No. PE34703		Cable Dia.	Attn. @ 1 GHz	Power @ 1 GHz	57		
1 piece price shown. See web or call for volume pricing.		0.100" dia.	25 dB/100ft	200 W			
12"	24"	36"	48"	60"		72"	Custom Len.
\$53.50	\$56.06	\$58.62	\$61.32	\$59.94		\$62.30	See Web
RG187A/U Coax, 75 Ohm							
Part No. PE34705		Cable Dia.	Attn. @ 1 GHz	Power @ 1 GHz	58		
1 piece price shown. See web or call for volume pricing.		0.110" dia.	25 dB/100ft	200 W			
12"	24"	36"	48"	60"		72"	Custom Len.
\$54.52	\$54.84	\$58.24	\$66.21	\$65.04		\$68.44	See Web

Cable Assemblies

See Our Website For Current Pricing & Real-Time Stock Availability!

For Custom Lengths, Metric Lengths or Special Configurations, Please call (949) 261-1920

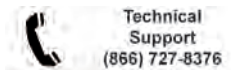

For our complete selection of cable assemblies, please visit our website

75 OHM MINI SMB PLUG TO
75 OHM MINI SMB PLUG



Standard Flexible Cable Assemblies

RG59B/U Coax, 75 Ohm

Part No. PE34681	Cable Dia.				Attn. @ 1 GHz	Power @ 1 GHz
1 piece price shown. See web or call for volume pricing.						
12"	24"	36"	48"	0.242" dia.	12 dB/100ft	77 W
\$51.21	\$52.12	\$53.01	\$53.92	\$54.82	72"	Custom Len.
See Web						

59

RG179B/U Coax, 75 Ohm

Part No. PE34683	Cable Dia.				Attn. @ 1 GHz	Power @ 1 GHz
1 piece price shown. See web or call for volume pricing.						
12"	24"	36"	48"	0.100" dia.	25 dB/100ft	200 W
\$53.99	\$56.34	\$58.70	\$61.07	\$63.44	72"	Custom Len.
See Web						

60

RG187A/U Coax, 75 Ohm

Part No. PE34685	Cable Dia.				Attn. @ 1 GHz	Power @ 1 GHz
1 piece price shown. See web or call for volume pricing.						
12"	24"	36"	48"	0.110" dia.	25 dB/100ft	200 W
\$51.83	\$55.12	\$58.42	\$66.62	\$64.96	72"	Custom Len.
See Web						

61

75 OHM MINI SMB PLUG TO
75 OHM MINI SMB PLUG RIGHT ANGLE



Standard Flexible Cable Assemblies

RG59B/U Coax, 75 Ohm

Part No. PE34687	Cable Dia.				Attn. @ 1 GHz	Power @ 1 GHz
1 piece price shown. See web or call for volume pricing.						
12"	24"	36"	48"	0.242" dia.	12 dB/100ft	77 W
\$58.71	\$59.62	\$60.51	\$61.43	\$62.32	72"	Custom Len.
See Web						

62

RG179B/U Coax, 75 Ohm

Part No. PE34689	Cable Dia.				Attn. @ 1 GHz	Power @ 1 GHz
1 piece price shown. See web or call for volume pricing.						
12"	24"	36"	48"	0.100" dia.	25 dB/100ft	200 W
\$65.84	\$62.20	\$64.59	\$67.01	\$69.35	72"	Custom Len.
See Web						

63

75 OHM MINI SMB PLUG RIGHT ANGLE
TO 75 OHM F FEMALE BULKHEAD



SEE MOUNTING HOLE SECTION ON PAGE 369

Standard Flexible Cable Assemblies

RG187A/U Coax, 75 Ohm

Part No. PE3W07602	Cable Dia.				Attn. @ 1 GHz	Power @ 1 GHz
1 piece price shown. See web or call for volume pricing.						
12"	24"	36"	48"	0.102" dia.	dB/100ft	200 W
\$48.21	\$52.36	\$56.51	\$60.67	\$64.82	50CM	Custom Len.
See Web						

64

75 OHM MINI SMB PLUG RIGHT ANGLE TO
75 OHM MINI SMB PLUG RIGHT ANGLE



Standard Flexible Cable Assemblies

RG179B/U Coax, 75 Ohm

Part No. PE34694	Cable Dia.				Attn. @ 1 GHz	Power @ 1 GHz
1 piece price shown. See web or call for volume pricing.						
12"	24"	36"	48"	0.100" dia.	25 dB/100ft	200 W
\$75.98	\$71.45	\$81.09	\$76.18	\$78.54	72"	Custom Len.
See Web						

65

75 OHM N MALE TO 75 OHM BNC MALE



Standard Flexible Cable Assemblies

RG6A/U Coax, 75 Ohm

Part No. PE3341	Cable Dia.				Attn. @ 1 GHz	Power @ 1 GHz
1 piece price shown. See web or call for volume pricing.						
12"	24"	36"	48"	0.332" dia.	11 dB/100ft	125 W
\$56.23	\$55.74	\$58.41	\$61.08	\$63.76	72"	Custom Len.
See Web						

66

RG11A/U Coax, 75 Ohm

Part No. PE3396	Cable Dia.				Attn. @ 1 GHz	Power @ 1 GHz
1 piece price shown. See web or call for volume pricing.						
12"	24"	36"	48"	0.405" dia.	dB/100ft	150 W
\$65.80	\$67.47	\$69.16	\$70.79	\$72.47	72"	Custom Len.
See Web						

67

RG59B/U Coax, 75 Ohm

Part No. PE33605	Cable Dia.				Attn. @ 1 GHz	Power @ 1 GHz
1 piece price shown. See web or call for volume pricing.						
12"	24"	36"	48"	0.242" dia.	12 dB/100ft	77 W
\$48.38	\$49.34	\$50.31	\$55.42	\$52.22	72"	Custom Len.
See Web						

68

RG179B/U Coax, 75 Ohm

Part No. PE3398	Cable Dia.				Attn. @ 1 GHz	Power @ 1 GHz
1 piece price shown. See web or call for volume pricing.						
12"	24"	36"	48"	0.100" dia.	25 dB/100ft	200 W
\$58.82	\$61.18	\$67.46	\$70.17	\$72.77	72"	Custom Len.
See Web						

69

RG187A/U Coax, 75 Ohm

Part No. PE3400	Cable Dia.				Attn. @ 1 GHz	Power @ 1 GHz
1 piece price shown. See web or call for volume pricing.						
12"	24"	36"	48"	0.110" dia.	25 dB/100ft	200 W
\$56.43	\$59.67	\$62.98	\$66.29	\$69.57	72"	Custom Len.
See Web						

70

75 OHM N MALE TO 75 OHM F MALE



Low Loss Flexible Cable Assemblies

PE-SF200LL75 Coax, 75 Ohm

Part No. PE3TC1205	Cable Dia.				Attn. @ 1 GHz	Power @ 1 GHz
1 piece price shown. See web or call for volume pricing.						
24"	36"	48"	72"	0.195" dia.	dB/100ft	W
\$118.12	\$129.38	\$140.64	\$163.15	\$132.55	200CM	Custom Len.
See Web						

71

Standard Flexible Cable Assemblies

PE-75Test.35 Coax, 75 Ohm

Part No. PE3CA1031	Cable Dia.				Attn. @ 1 GHz	Power @ 1 GHz
1 piece price shown. See web or call for volume pricing.						
60CM	-	-	-	0.300" dia.	dB/100ft	W
\$262.32	-	-	-	-	-	Custom Len.
See Web						

72

75 OHM N MALE TO 75 OHM F FEMALE



Low Loss Flexible Cable Assemblies

PE-SF200LL75 Coax, 75 Ohm

Part No. PE3TC1204	Cable Dia.				Attn. @ 1 GHz	Power @ 1 GHz
1 piece price shown. See web or call for volume pricing.						
24"	36"	48"	72"	0.195" dia.	dB/100ft	W
\$118.12	\$129.38	\$140.64	\$163.15	\$132.55	200CM	Custom Len.
See Web						

73

75 OHM N MALE TO 75 OHM N MALE



Low Loss Flexible Cable Assemblies

PE-SF200LL75 Coax, 75 Ohm

Part No. PE3TC1200	Cable Dia.				Attn. @ 1 GHz	Power @ 1 GHz
1 piece price shown. See web or call for volume pricing.						
24"	36"	48"	72"	0.195" dia.	dB/100ft	W
\$150.35	\$161.61	\$172.87	\$195.38	\$164.78	200CM	Custom Len.
See Web						

74

Standard Flexible Cable Assemblies

RG6A/U Coax, 75 Ohm

Part No. PE3612	Cable Dia.				Attn. @ 1 GHz	Power @ 1 GHz
1 piece price shown. See web or call for volume pricing.						
12"	24"	36"	48"	0.332" dia.	11 dB/100ft	125 W
\$60.59	\$63.26	\$65.95	\$68.63	\$71.30	72"	Custom Len.
See Web						

75

RG11A/U Coax, 75 Ohm

Part No. PE3616	Cable Dia.				Attn. @ 1 GHz	Power @ 1 GHz
1 piece price shown. See web or call for volume pricing.						
12"	24"	36"	48"	0.405" dia.	dB/100ft	150 W
\$68.99	\$76.57	\$78.64	\$80.82	\$82.93	72"	Custom Len.
See Web						

76

RG59B/U Coax, 75 Ohm

Part No. PE3528	Cable Dia.				Attn. @ 1 GHz	Power @ 1 GHz
1 piece price shown. See web or call for volume pricing.						
12"	24"	36"	48"	0.242" dia.	12 dB/100ft	77 W
\$60.70	\$65.37	\$62.61	\$63.57	\$68.57	72"	Custom Len.
See Web						

77

RG179B/U Coax, 75 Ohm

Part No. PE3307	Cable Dia.				Attn. @ 1 GHz	Power @ 1 GHz
1 piece price shown. See web or call for volume pricing.						
12"	24"	36"	48"	0.100" dia.	29 dB/100ft	W
\$70.77	\$73.14	\$75.49	\$77.87	\$80.23	72"	Custom Len.
See Web						

78

RG187A/U Coax, 75 Ohm

Part No. PE3581	Cable Dia.				Attn. @ 1 GHz	Power @ 1 GHz
1 piece price shown. See web or call for volume pricing.						
12"	24"	36"	48"	0.110" dia.	25 dB/100ft	200 W
\$67.66	\$76.90	\$74.21	\$77.50	\$80.80	72"	Custom Len.
See Web						

79

PE-75Test.35 Coax, 75 Ohm

Part No. PE3CA1032	Cable Dia.				Attn. @ 1 GHz	Power @ 1 GHz
1 piece price shown. See web or call for volume pricing.						
60CM	-	-	-	0.300" dia.	dB/100ft	W
\$297.94	-	-	-	-	-	Custom Len.
See Web						

80

75 OHM N MALE TO 75 OHM N FEMALE



Low Loss Flexible Cable Assemblies

PE-SF200LL75 Coax, 75 Ohm

Part No. PE3TC1201	Cable Dia.				Attn. @ 1 GHz	Power @ 1 GHz
1 piece price shown. See web or call for volume pricing.						
24"	36"	48"	72"	0.195" dia.	dB/100ft	W
\$145.76	\$157.02	\$168.28	\$190.80	\$160.18	200CM	Custom Len.
See Web						

81

Cable Assemblies
See Our Website For Current Pricing & Real-Time Stock Availability!

*Coax Performance at 1 GHz Notes: Cable assembly max frequency may be lower than connector or coax max frequency

For our complete selection of cable assemblies, please visit our website

75 OHM N FEMALE TO 75 OHM N FEMALE



Standard Flexible Cable Assemblies

RG11A/U Coax, 75 Ohm

Part No. PE3W04530	Cable Dia.	Attn. @ 1 GHz	Power @ 1 GHz
1 piece price shown. See web or call for volume pricing.			
12"	0.405" dia.	dB/100ft	150 W
24"	60"	50CM	Custom Len.
\$87.05	\$89.26	\$91.47	\$93.69
\$95.90	\$88.46	See Web	

82

75 OHM SMB PLUG TO 75 OHM BNC MALE



Standard Flexible Cable Assemblies

RG59B/U Coax, 75 Ohm

Part No. PE33270	Cable Dia.	Attn. @ 1 GHz	Power @ 1 GHz
1 piece price shown. See web or call for volume pricing.			
12"	0.242" dia.	12 dB/100ft	77 W
24"	60"	72"	Custom Len.
\$52.72	\$53.76	\$54.80	\$51.69
\$52.66	\$53.60	See Web	

83

RG179B/U Coax, 75 Ohm

Part No. PE33247	Cable Dia.	Attn. @ 1 GHz	Power @ 1 GHz
1 piece price shown. See web or call for volume pricing.			
12"	0.100" dia.	25 dB/100ft	200 W
24"	60"	72"	Custom Len.
\$57.43	\$55.54	\$62.55	\$65.25
\$67.86	\$70.46	See Web	

84

PE-B150 Coax, 75 Ohm

Part No. PE33644	Cable Dia.	Attn. @ 1 GHz	Power @ 1 GHz
1 piece price shown. See web or call for volume pricing.			
12"	0.150" dia.	20 dB/100ft	25 W
24"	60"	72"	Custom Len.
\$58.56	\$59.35	\$60.14	\$60.93
\$61.72	\$62.51	See Web	

85

75 OHM SMB PLUG TO 75 OHM SMB PLUG



Standard Flexible Cable Assemblies

RG59B/U Coax, 75 Ohm

Part No. PE3041	Cable Dia.	Attn. @ 1 GHz	Power @ 1 GHz
1 piece price shown. See web or call for volume pricing.			
12"	0.242" dia.	12 dB/100ft	77 W
24"	60"	72"	Custom Len.
\$59.87	\$60.82	\$61.78	\$62.75
\$63.70	\$64.66	See Web	

86

RG179B/U Coax, 75 Ohm

Part No. PE3100	Cable Dia.	Attn. @ 1 GHz	Power @ 1 GHz
1 piece price shown. See web or call for volume pricing.			
12"	0.100" dia.	29 dB/100ft	W
24"	60"	72"	Custom Len.
\$54.22	\$61.11	\$58.95	\$61.34
\$63.76	\$71.59	See Web	

87

75 OHM SMC PLUG TO 75 OHM BNC MALE



Standard Flexible Cable Assemblies

RG59B/U Coax, 75 Ohm

Part No. PE33330	Cable Dia.	Attn. @ 1 GHz	Power @ 1 GHz
1 piece price shown. See web or call for volume pricing.			
12"	0.242" dia.	12 dB/100ft	77 W
24"	60"	72"	Custom Len.
\$46.08	\$49.88	\$48.01	\$48.96
\$53.08	\$50.88	See Web	

88

RG179B/U Coax, 75 Ohm

Part No. PE33586	Cable Dia.	Attn. @ 1 GHz	Power @ 1 GHz
1 piece price shown. See web or call for volume pricing.			
12"	0.100" dia.	25 dB/100ft	200 W
24"	60"	72"	Custom Len.
\$60.15	\$59.10	\$65.26	\$63.83
\$70.57	\$73.18	See Web	

89

PE-B150 Coax, 75 Ohm

Part No. PE33646	Cable Dia.	Attn. @ 1 GHz	Power @ 1 GHz
1 piece price shown. See web or call for volume pricing.			
12"	0.150" dia.	20 dB/100ft	25 W
24"	60"	72"	Custom Len.
\$63.20	\$67.92	\$64.78	\$65.57
\$66.36	\$71.69	See Web	

90

75 OHM SMC PLUG TO 75 OHM SMC PLUG



Standard Flexible Cable Assemblies

RG59B/U Coax, 75 Ohm

Part No. PE3362	Cable Dia.	Attn. @ 1 GHz	Power @ 1 GHz
1 piece price shown. See web or call for volume pricing.			
12"	0.242" dia.	12 dB/100ft	77 W
24"	60"	72"	Custom Len.
\$56.84	\$57.80	\$64.61	\$59.71
\$60.68	\$61.64	See Web	

91

RG179B/U Coax, 75 Ohm

Part No. PE3376	Cable Dia.	Attn. @ 1 GHz	Power @ 1 GHz
1 piece price shown. See web or call for volume pricing.			
12"	0.100" dia.	25 dB/100ft	200 W
24"	60"	72"	Custom Len.
\$58.95	\$61.29	\$63.70	\$66.04
\$68.44	\$70.84	See Web	

92

PE-B150 Coax, 75 Ohm				Cable Dia.	Attn. @ 1 GHz	Power @ 1 GHz
Part No. PE3388				0.150" dia.	20 dB/100ft	25 W
1 piece price shown. See web or call for volume pricing.						
12"	24"	36"	48"	60"	72"	Custom Len.
\$71.42	\$76.63	\$73.00	\$73.79	\$74.58	\$75.37	See Web

93

75 OHM TNC MALE TO 75 OHM BNC MALE



Standard Flexible Cable Assemblies

RG6A/U Coax, 75 Ohm

Part No. PE35350	Cable Dia.	Attn. @ 1 GHz	Power @ 1 GHz
1 piece price shown. See web or call for volume pricing.			
12"	0.332" dia.	11 dB/100ft	125 W
24"	60"	72"	Custom Len.
\$50.73	\$50.55	\$53.22	\$55.89
\$58.57	\$61.25	See Web	

94

RG11A/U Coax, 75 Ohm

Part No. PE35354	Cable Dia.	Attn. @ 1 GHz	Power @ 1 GHz
1 piece price shown. See web or call for volume pricing.			
12"	0.405" dia.	dB/100ft	150 W
24"	60"	72"	Custom Len.
\$80.05	\$81.78	\$83.48	\$85.21
\$86.93	\$88.64	See Web	

95

RG59B/U Coax, 75 Ohm

Part No. PE35358	Cable Dia.	Attn. @ 1 GHz	Power @ 1 GHz
1 piece price shown. See web or call for volume pricing.			
12"	0.242" dia.	12 dB/100ft	77 W
24"	60"	72"	Custom Len.
\$43.59	\$44.53	\$45.50	\$46.45
\$47.41	\$51.49	See Web	

96

RG179B/U Coax, 75 Ohm

Part No. PE35362	Cable Dia.	Attn. @ 1 GHz	Power @ 1 GHz
1 piece price shown. See web or call for volume pricing.			
12"	0.100" dia.	25 dB/100ft	200 W
24"	60"	72"	Custom Len.
\$57.78	\$60.33	\$58.23	\$60.60
\$62.96	\$65.32	See Web	

97

75 OHM TNC MALE TO 75 OHM TNC MALE



Standard Flexible Cable Assemblies

RG6A/U Coax, 75 Ohm

Part No. PE35348	Cable Dia.	Attn. @ 1 GHz	Power @ 1 GHz
1 piece price shown. See web or call for volume pricing.			
12"	0.332" dia.	11 dB/100ft	125 W
24"	60"	72"	Custom Len.
\$53.24	\$55.91	\$58.59	\$61.26
\$63.94	\$66.62	See Web	

98

RG11A/U Coax, 75 Ohm

Part No. PE35352	Cable Dia.	Attn. @ 1 GHz	Power @ 1 GHz
1 piece price shown. See web or call for volume pricing.			
12"	0.405" dia.	dB/100ft	150 W
24"	60"	72"	Custom Len.
\$88.37	\$89.99	\$91.66	\$93.28
\$94.96	\$96.65	See Web	

99

RG59B/U Coax, 75 Ohm

Part No. PE35356	Cable Dia.	Attn. @ 1 GHz	Power @ 1 GHz
1 piece price shown. See web or call for volume pricing.			
12"	0.242" dia.	12 dB/100ft	77 W
24"	60"	72"	Custom Len.
\$51.10	\$55.20	\$56.24	\$53.98
\$54.93	\$59.45	See Web	

1

RG179B/U Coax, 75 Ohm

Part No. PE35360	Cable Dia.	Attn. @ 1 GHz	Power @ 1 GHz
1 piece price shown. See web or call for volume pricing.			
12"	0.100" dia.	25 dB/100ft	200 W
24"	60"	72"	Custom Len.
\$65.05	\$62.60	\$64.96	\$67.33
\$69.70	\$78.09	See Web	

2

BNC TWINAX PLUG TO BNC TWINAX PLUG



Standard Flexible Cable Assemblies

RG108A/U Coax, 78 Ohm

Part No. PE3480	Cable Dia.	Attn. @ 1 GHz	Power @ 1 GHz
1 piece price shown. See web or call for volume pricing.			
18"	0.235" dia.	26 dB/100ft	30 W
36"	60"	180"	Custom Len.
\$75.77	\$79.51	\$84.69	\$110.09
\$97.41	\$110.11	See Web	

3

3/4"-20 TWINAX MALE TO 3/4"-20 TWINAX MALE



Standard Flexible Cable Assemblies

PE-S330 Coax, 100 Ohm

Part No. PE3930	Cable Dia.	Attn. @ 1 GHz	Power @ 1 GHz
1 piece price shown. See web or call for volume pricing.			
18"	0.330" dia.	dB/100ft	W
36"	60"	180"	Custom Len.
\$80.29	\$84.27	\$89.58	\$96.22
\$102.85	\$116.12	See Web	

4

For Custom Lengths, Metric Lengths or Special Configurations, Please call (949) 261-1920

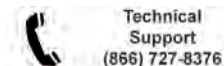

Technical Support
(866) 727-8376



Same-Day Shipping,
Even Custom
Cable Assemblies

Cable Assemblies

See Our Website For Current Pricing & Real-Time Stock Availability!

CIRCULATORS AND ISOLATORS

Circulators

Dual Junction



Connector	Frequency Range (MHz.)	Maximum Power	VSWR Max.	Isolation (dB Min.)	Model No	1 Pc. Price	See Web for Volume Pricing	ROW
N	1,000 - 2,000	10 Watt	1.35:1	36	PE83CR1014	\$1,358.22	See Web for Volume Pricing	1
	1,700 - 2,200		1.25:1	40	PE83CR1016	\$859.74		2
	2,000 - 4,000	5 Watt	1.3:1	36	PE83CR1018	\$863.37		3
	4,000 - 8,000			40	PE83CR1020	\$655.78		4
7,000 - 12,400	5 Watt	40	PE83CR1022	\$609.75	5			
SMA	1,000 - 2,000	10 Watt	1.35:1	36	PE83CR1013	\$1,467.64		6
	1,700 - 2,200		1.25:1	40	PE83CR1015	\$893.27		7
	2,000 - 4,000		1.3:1	36	PE83CR1017	\$776.17		8
	4,000 - 8,000	40		PE83CR1019	\$765.65	9		
	7,000 - 12,400	5 Watt	40	PE83CR1021	\$609.75	10		
	8,000 - 18,000		1.45:1	32	PE83CR1023	\$754.25		11
	11,000 - 18,000		1.25:1	40	PE83CR1024	\$791.94		12
	18,000 - 26,500		1.4:1	34	PE83CR1025	\$889.19		13

Single Junction



Connector	Frequency Range (MHz.)	Maximum Power	VSWR Max.	Isolation (dB Min.)	Model No	1 Pc. Price	See Web for Volume Pricing	ROW
2.92mm	18,000 - 26,500	10 Watt	1.8:1	12	PE83CR1027	\$980.00	See Web for Volume Pricing	14
	22,000 - 33,000		1.7:1	13	PE83CR1028	\$940.00		15
	26,500 - 40,000		1.8:1	12	PE83CR1032	\$1,062.86		16
	32,000 - 36,000		14	PE83CR1029	\$1,008.57	17		
N	135 - 175	150 Watt	1.3:1	20	PE8427	\$1,518.57		18
	330 - 403				PE8429	\$1,353.30		19
	380 - 460	1000 Watt	1.25:1	20	PE8423	\$525.78		20
	450 - 520	150 Watt			PE8431	\$1,293.60		21
	698 - 960	1000 Watt	1.3:1	18	PE8419	\$432.08		22
	1,000 - 2,000	10 Watt	1.35:1		PE8410	\$970.81		23
	1,000 - 2,000	50 Watt		1.25:1	PE83CR1001	\$1,154.11		24
	1,700 - 2,200	10 Watt	PE8415		\$445.35	25		
	1,700 - 2,200	50 Watt	1.3:1	20	PE83CR1003	\$715.23		26
	2,000 - 4,000	10 Watt			PE8411	\$744.97		27
	2,000 - 4,000	50 Watt	1.35:1	18	PE83CR1005	\$689.40		28
	2,000 - 4,000	100 Watt			PE83CR1031	\$362.86		29
	4,000 - 8,000	10 Watt	1.3:1	18	PE8412	\$599.62		30
	4,000 - 8,000	50 Watt			PE83CR1007	\$543.71		31
	7,000 - 12,400	10 Watt	1.25:1	20	PE8413	\$513.76		32
	7,000 - 12,400	50 Watt			PE83CR1009	\$447.18		33
SMA	135 - 175	150 Watt	1.3:1	20	PE8426	\$1,548.94		34
	330 - 403				PE8428	\$1,406.08		35
	380 - 460	1000 Watt	1.25:1	18	PE8422	\$525.78		36
	450 - 520	150 Watt			PE8430	\$1,293.60		37
	698 - 960	1000 Watt	1.3:1	19	PE8418	\$457.10		38
	700 - 800	10 Watt	1.25:1		PE83CR001	\$194.91		39
	800 - 960			PE83CR007	\$248.59	40		
	1,000 - 2,000	1 Watt	1.35:1	18	PE8400	\$763.20		41
	1,000 - 2,000	10 Watt			PE83CR003	\$385.19		42
	1,000 - 2,000	50 Watt	1.25:1	18	PE83CR1000	\$1,154.11		43
	1,700 - 2,200	10 Watt			PE8414	\$472.44		44
	1,700 - 2,200	50 Watt	1.3:1	20	PE83CR1002	\$687.72		45
	1,700 - 2,400	10 Watt			PE83CR004	\$191.33		46
	2,000 - 4,000	1 Watt	1.3:1	18	PE8401	\$508.30	47	
	2,000 - 4,000	10 Watt			PE83CR005	\$306.59	48	
	2,000 - 4,000	50 Watt	1.3:1	20	PE83CR1004	\$650.75	49	
	2,000 - 4,000	100 Watt	1.35:1	18	PE83CR1030	\$391.43	50	
	2,000 - 6,000	25 Watt	1.5:1	14	PE8432	\$882.93	51	
	3,000 - 5,000	10 Watt	1.3:1	18	PE83CR1033	\$437.14	52	
	4,000 - 8,000		1.35:1	17	PE83CR006	\$296.39	53	
4,000 - 8,000	50 Watt	1.3:1	18	PE8402	\$311.38	54		
4,000 - 8,000				PE83CR1006	\$523.30	55		
4,000 - 8,000	80 Watt	1.4:1	17	PE83CR1034	\$408.57	56		
6,000 - 18,000	10 Watt	1.5:1	14	PE8433	\$789.38	57		

Circulators & Isolators

See Our Website For Current Pricing & Real-Time Stock Availability!

Circulators

Single Junction



Connector	Frequency Range (MHz.)	Maximum Power	VSWR Max.	Isolation (dB Min.)	Model No	1 Pc. Price	See Web for Volume Pricing	ROW
SMA	7,000 - 12,400	10 Watt	1.3:1	18	PE83CR000	\$303.06	See Web for Volume Pricing	58
	7,000 - 12,400				PE8403	\$291.70		59
	7,000 - 12,400	50 Watt	1.25:1	20	PE83CR1008	\$464.62		60
	8,000 - 18,000				PE83CR002	\$311.26		61
	8,000 - 18,000	50 Watt	1.45:1	16	PE83CR1010	\$470.92		62
	8,000 - 12,000				PE83CR1026	\$505.71		63
	8,000 - 18,000	10 Watt	1.45:1	16	PE8404	\$347.67		64
	11,000 - 18,000				PE8405	\$354.03		65
	11,000 - 18,000	50 Watt	1.25:1	20	PE83CR1011	\$453.31		66
	18,000 - 26,500				PE8406	\$355.56		67
	18,000 - 26,500	50 Watt	1.4:1	17	PE83CR1012	\$529.49		68

Isolators

Dual Junction



Connector	Frequency Range (MHz.)	Maximum Power	VSWR Max.	Isolation (dB Min.)	Model No	1 Pc. Price	See Web for Volume Pricing	ROW
N	1,000 - 2,000	10 Watt	1.35:1	36	PE83IR1014	\$1,411.19	See Web for Volume Pricing	69
	1,700 - 2,200				PE83IR1016	\$826.67		70
	2,000 - 4,000			36	PE83IR1018	\$794.52		71
	4,000 - 8,000				PE83IR1020	\$681.36		72
7,000 - 12,400	5 Watt	1.25:1	40	PE83IR1022	\$586.86	73		
1,000 - 2,000				PE83IR1013	\$1,411.19	74		
SMA	1,700 - 2,200	10 Watt	1.25:1	40	PE83IR1015	\$858.91		75
	2,000 - 4,000				PE83IR1017	\$810.41		76
	4,000 - 8,000			36	PE83IR1019	\$750.93		77
	7,000 - 12,400				PE83IR1021	\$634.14		78
	8,000 - 18,000	5 Watt	1.25:1	32	PE83IR1023	\$754.25		79
	11,000 - 18,000				PE83IR1024	\$761.47		80
	18,000 - 26,500			34	PE83IR1025	\$889.19	81	

Single Junction



Connector	Frequency Range (MHz.)	Maximum Power	VSWR Max.	Isolation (dB Min.)	Model No	1 Pc. Price	See Web for Volume Pricing	ROW		
2.4mm	35,000 - 42,500	10 Watt	1.6:1	14	PE83IR1038	\$951.43	See Web for Volume Pricing	82		
2.92mm	18,000 - 26,500	10 Watt	1.7:1	14	PE83IR1033	\$748.57		83		
	18,000 - 26,500				PE83IR1041	\$1,622.86		84		
	22,000 - 33,000			1.8:1	13	PE83IR1035		\$748.57	85	
	26,500 - 40,000					PE83IR1036		\$748.57	86	
	26,500 - 40,000			5 Watt	1.5:1	14		PE8310	\$1,136.04	87
	26,500 - 40,000							PE8320	\$1,136.04	88
27,000 - 31,000	1.25:1	20	PE8319	\$1,003.36	89					
135 - 175			PE8322	\$1,518.57	90					
N	330 - 403	150 Watt	1.3:1	20	PE8324	\$1,037.96		91		
	380 - 460	100 Watt			PE8425	\$538.12		92		
	450 - 520	150 Watt	PE8326	\$999.00	93					
	698 - 960	1000 Watt	1.3:1	18	PE8421	\$467.99	94			
	1,000 - 2,000	10 Watt			PE8310	\$1,124.82	95			
	1,000 - 2,000		50 Watt	1.35:1	17	PE83IR003	\$400.48	96		
	1,000 - 2,000	PE83IR1001				\$1,245.76	97			
	1,700 - 2,200	10 Watt	1.25:1	18	PE8417	\$258.09	98			
	1,700 - 2,200				PE83IR1003	\$743.12	99			
	2,000 - 4,000	10 Watt	1.3:1	18	PE8311	\$702.27	1			
	2,000 - 4,000				PE83IR1005	\$695.09	2			
	4,000 - 8,000	10 Watt	18	PE8312	\$599.61	3				

Circulators & Isolators

See Our Website For Current Pricing & Real-Time Stock Availability!

Isolators

Single Junction



Connector	Frequency Range (MHz.)	Maximum Power	VSWR Max.	Isolation (dB Min.)	Model No	1 Pc. Price	See Web for Volume Pricing			ROW
N	4,000 - 8,000	50 Watt	1.3:1	18	PE83JR1007	\$611.97				4
	7,000 - 12,400	10 Watt	1.25:1	20	PE8313	\$760.82				5
SMA	135 - 175	150 Watt	1.3:1	20	PE8321	\$1,718.28				6
	330 - 403				PE8323	\$1,406.08				7
	380 - 460	100 Watt	1.25:1	20	PE8424	\$502.91				8
	450 - 520	150 Watt			PE8325	\$1,293.60				9
	698 - 960	1000 Watt	1.3:1	18	PE8420	\$448.93				10
	800 - 900	100 Watt	1.25:1	20	PE83JR007	\$227.39				11
	1,000 - 2,000	10 Watt	1.35:1	18	PE8300	\$699.97				12
	1,000 - 2,000		1.4:1	17	PE83JR002	\$315.42				13
	1,000 - 2,000		1.5:1	16	PE83JR1032	\$654.29				14
	1,000 - 2,000	50 Watt	1.35:1	18	PE83JR1000	\$1,175.61				15
	1,700 - 2,200	10 Watt	1.25:1		PE8416	\$472.44				16
	1,700 - 2,200	50 Watt	1.35:1	20	PE83JR1002	\$743.12				17
	1,700 - 2,400	10 Watt			PE83JR004	\$220.36				18
	2,000 - 4,000	1 Watt	1.3:1	18	PE8301	\$519.47				19
	2,000 - 4,000	10 Watt	1.4:1		PE83JR005	\$306.59				20
	2,000 - 4,000	50 Watt	1.3:1	20	PE83JR1004	\$689.40				21
	2,000 - 6,000	10 Watt	1.8:1	12	PE83JR1039	\$442.86				22
	2,000 - 6,000	25 Watt	1.5:1	14	PE8327	\$810.39				23
	2,000 - 8,000	10 Watt	1.35:1	15	PE8316	\$1,321.46				24
	2,000 - 10,000			13	PE8317	\$1,321.46				25
	3,500 - 12,800	2 Watt	1.5:1	17	PE8314	\$1,222.46				26
	4,000 - 8,000	1 Watt	1.3:1	18	PE8302	\$311.67				27
	4,000 - 8,000	10 Watt	1.35:1		PE83JR006	\$303.69				28
	4,000 - 8,000	30 Watt		19	PE83JR1040	\$448.57				29
	4,000 - 8,000	50 Watt	1.3:1	18	PE83JR1006	\$508.13				30
	4,000 - 18,000	10 Watt	1.5:1	15	PE8315	\$1,255.92				31
	6,000 - 18,000			14	PE8328	\$986.83				32
	6,000 - 18,000		1.6:1	10	PE83JR1029	\$502.86				33
	6,000 - 18,000				PE83JR1030	\$502.86				34
	6,000 - 18,000	PE83JR1031	\$502.86					35		
7,000 - 12,400	1 Watt	1.3:1	18	PE8303	\$292.10				36	
7,000 - 12,400	10 Watt			PE83JR000	\$287.43				37	
8,000 - 12,000		1.35:1	20	PE83JR1026	\$388.57				38	
8,000 - 12,000				PE83JR1027	\$388.57				39	
8,000 - 18,000	1 Watt	1.45:1	16	PE8304	\$316.75				40	
8,000 - 18,000	10 Watt	1.5:1		PE83JR001	\$281.96				41	
8,000 - 18,000	50 Watt	1.45:1	20	PE83JR1010A	\$470.91				42	
11,000 - 18,000	1 Watt	1.25:1		PE8305	\$286.31				43	
11,000 - 18,000	50 Watt		1.35:1	PE83JR1011	\$485.04				44	
12,000 - 18,000	10 Watt	PE83JR1028		\$411.43				45		
17,300 - 22,000		1.25:1	PE8318	\$533.20				46		
18,000 - 26,500	1 Watt	1.4:1	17	PE8306	\$311.48				47	
18,000 - 26,500	10 Watt	1.7:1	14	PE83JR1034	\$737.14				48	
18,000 - 26,500	50 Watt	1.4:1	17	PE83JR1012	\$550.14				49	

See Web for Volume Pricing

Circulators & Isolators

See Our Website For Current Pricing & Real-Time Stock Availability!

INDEX GUIDE TO COAXIAL CABLES

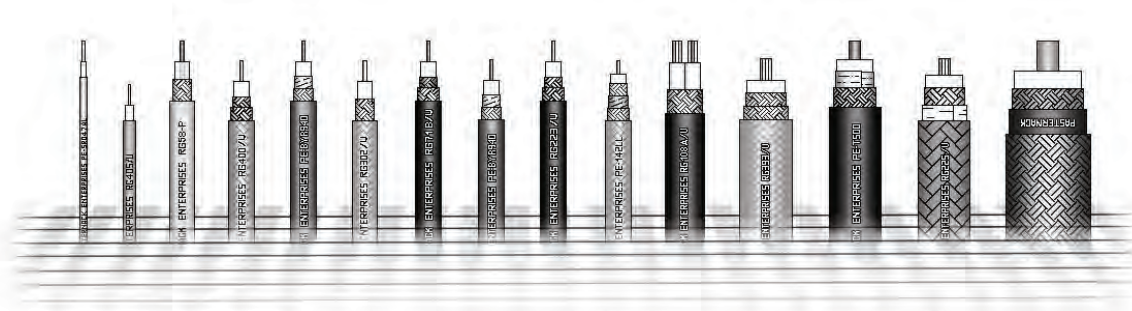

COAXIAL CABLES.....193

75 OHM BROADCAST.....194



Pasternack's selection of 75 Ohm Broadcast coaxial cable includes RG59-P plenum cable, commercial grade RG6-CATV, HD mini 59 cable in multiple colors as well as PTFE jacketed RG187A/U.

RG MIL-C-17 TYPE CABLE.....196



Pasternack offers 31 different MIL-C-17 compliant coaxial cable types. These cables are available in various diameters, jacket materials, impedances, and velocity factors, providing numerous RF cable options to fit your specific requirements.

COMMUNICATIONS.....194

Our selection of Low Loss cable is designed with high Velocity Factor (VF) dielectric materials and two outer shields for communications applications requiring Low Loss and High Isolation. These cables are offered in several popular sizes including 0.195", 0.240", 0.400", and 0.600" diameters.



SEMIRIGID AND FORMABLE.....197

Pasternack's Precision Cables are designed for RF and Microwave applications with frequencies up to 65 GHz. These cables are constructed of copper jacketed and tinned aluminum semirigid designs; and tinned braid conformable cable in both FEP jacketed and unjacketed designs. The semi rigid and conformable cables are available from 0.020 to 0.250 inches in diameter.

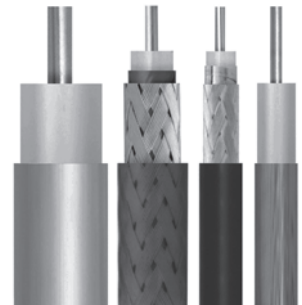

HIGH PERFORMANCE.....195



Pasternack's line of High Performance Flexible Cable has high Velocity Factors of 70 to 85% and incorporate Spiral Wrapped outer conductors for superior shielding under flexure. These cables are used as flexible cable alternatives to semirigid cable and in many cases use the same connectors.

TWINAX.....198



Pasternack offers two versions of Twinax cable with an impedance of 100 or 78 ohms. Twinax cable has two center conductors surrounded by a dielectric. The dielectric is surrounded by a braided outer conductor covered by a PVC jacket material. This construction creates a shielded, twisted pair with superior performance when compared to unshielded, twisted pair cable.

Coaxial
Cables

COAXIAL CABLES

Meets or Exceeds MIL-C-17 Specifications Where Applicable

MODEL NO.	COAX IMPEDANCE (Ohm)	JACKET DIAMETER (in)	NUMBER OF SHIELDS	VELOCITY FACTOR (%)	MAX. POWER HANDLING AT 1 GHz (W)	JACKET MATERIAL	PRICE PER FOOT		ROW
	MAXIMUM FREQUENCY (GHz.)	CONDUCTOR DIAM.(in) [strands]	RF SHIELDING (min dB)	ATTENUATION AT 1 GHz. (dB/100 ft)	MAXIMUM OPERATING VOLTAGE (V RMS)	MINIMUM BEND RADIUS (in)	1-99 FT 500-999 FT	100-499 FT 1000 + FT	
75 OHM BROADCAST									
LMR-400-75	75 2.5	0.405 0.065[1]	2 90	85		PE 1	\$1.32 \$1.32	\$1.32 \$1.32	1
PE-B150	75 5	0.150 0.017[7]	1	20	25 600	PVC	\$1.03 \$0.93	\$0.98 \$0.89	2
PE-B159-BK	75 3	0.159 0.023[1]	2	83 10.5	300	PVC 1.5	\$1.00 \$0.90	\$0.95 \$0.86	3
PE-B159-BL	75 3	0.159 0.023[1]	2	83 10.5	300	PVC 1.5	\$1.05 \$0.95	\$1.00 \$0.90	4
PE-B159-GR	75 3	0.159 0.023[1]	2	83 10.5	300	PVC 1.5	\$0.86 \$0.77	\$0.82 \$0.74	5
PE-B159-RD	75 3	0.159 0.023[1]	2	83 10.5	300	PVC 1.5	\$0.90 \$0.81	\$0.86 \$0.77	6
PE-B159-WH	75 3	0.159 0.023[1]	2	83 10.5	300	PVC 1.5	\$0.81 \$0.73	\$0.77 \$0.70	7
PE-B159-YW	75 3	0.159 0.023[1]	2	83 10.5	300	PVC 1.5	\$0.85 \$0.77	\$0.81 \$0.73	8
PE-B305	75 1	0.305 0.031[1]	2	9.2	52 2,900	PVC	\$2.58 \$2.32	\$2.45 \$2.22	9
RG11A/U	75 1	0.405 [7]	1 45	66 8.11	150	PVC	\$2.21 \$1.99	\$2.10 \$1.90	10
RG179B/U	75 3	0.100 0.012[7]	1	70 29.15	900	FEP	\$2.69 \$2.42	\$2.56 \$2.31	11
RG187A/U	75 3	0.102 0.012[7]	1	70 25	200 2,000	PTFE	\$4.16 \$3.74	\$3.95 \$3.58	12
RG302/U	75 3	0.206 0.025[7]	1	69 13	650 1,700	FEP	\$7.03 \$6.33	\$6.68 \$6.05	13
RG59B/U	75 1	0.242 0.022[1]	1	66 11.5	77 2,300	PVC (NC)	\$1.01 \$0.91	\$0.96 \$0.87	14
RG6A/U	75 1	0.332 0.029[1]	2 90	66 11	100	PVC (NC)	\$4.16 \$3.74	\$3.95 \$3.58	15
RG6-CATV	75 3	0.278 0.04[1]	3 70	85 6.55	6.5	PVC (NC)	\$1.34 \$1.21	\$1.27 \$1.15	16
COMMUNICATIONS									
LMR-100A-PVC	50 5.8	0.110 0.018[1]	2 90	66 24		PVC 0.25	\$0.74 \$0.74	\$0.74 \$0.74	17
LMR-195	50 5.8	0.195 0.037[1]	2 90	80 11.8		PE 0.5	\$0.65 \$0.65	\$0.65 \$0.65	18
LMR-195-FR	50 5.8	0.195 0.037[1]	2 90	76 11.8		FRPE 0.5	\$1.01 \$1.01	\$1.01 \$1.01	19
LMR-200	50 5.8	0.195 0.044[1]	2 90	83 10.5		PE 0.5	\$0.72 \$0.72	\$0.72 \$0.72	20
LMR-200-FR	50 5.8	0.195 0.044[1]	2 90	83		FRPE 0.5	\$1.02 \$1.02	\$1.02 \$1.02	21
LMR-200-UF	50 5.8	0.195 0.044	2 90	83 12.18		TPE 0.5	\$2.15 \$2.15	\$2.15 \$2.15	22
LMR-240	50 5.8	0.240 0.056[1]	2 90	84 8		PE 0.75	\$0.89 \$0.89	\$0.89 \$0.89	23
LMR-240-DB	50 5.8	0.240 0.056[1]	2 90	84 7.66		PE 0.75	\$1.02 \$1.02	\$1.02 \$1.02	24
LMR-240-UF	50 5.8	0.240 0.056	2 90	84 9.19		TPE 0.75	\$1.08 \$1.08	\$1.08 \$1.08	25
LMR-400	50 6	0.405 0.108[1]	2 90	85 4.25		PE 1	\$1.26 \$1.26	\$1.26 \$1.26	26

Coaxial Cables

See Our Website For Current Pricing & Real-Time Stock Availability!

COAXIAL CABLES

Meets or Exceeds MIL-C-17 Specifications Where Applicable

MODEL NO.	COAX IMPEDANCE (Ohm)	JACKET DIAMETER (in)	NUMBER OF SHIELDS	VELOCITY FACTOR (%)	MAX. POWER HANDLING AT 1 GHz (W)	JACKET MATERIAL	PRICE PER FOOT		ROW
	MAXIMUM FREQUENCY (GHz.)	CONDUCTOR DIAM.(in) [strands]	RF SHIELDING (min dB)	ATTENUATION AT 1 GHz. (dB/100 ft)	MAXIMUM OPERATING VOLTAGE (V RMS)	MINIMUM BEND RADIUS (in)	1-99 FT 500-999 FT	100-499 FT 1000 + FT	
COMMUNICATIONS									
LMR-400-DB	50 6	0.405 0.108[1]	2 90	85 4.15		PE 1	\$1.34 \$1.34	\$1.34 \$1.34	27
LMR-400-UF	50 5.8	0.405 0.108	2 90	85 5		TPE 1	\$1.82 \$1.82	\$1.82 \$1.82	28
LMR-500	50 5.8	0.500 0.142[1]	2 90	86 3.1		PE 1.25	\$2.00 \$2.00	\$2.00 \$2.00	29
LMR-500-DB	50 5.8	0.500 0.142[1]	2 90	86 3.1		PE 1.25	\$2.25 \$2.25	\$2.25 \$2.25	30
LMR-600	50 5.8	0.590 0.176[1]	2 90	87 2.62		PE 1.5	\$2.27 \$2.27	\$2.27 \$2.27	31
LMR-600-DB	50 5.8	0.590 0.176[1]	2 90	87 2.62		PE 1.5	\$2.72 \$2.72	\$2.72 \$2.72	32
LMR-SW396	50 5.8	0.450 [1]	1 100	87 3.2		PE 2	\$1.26 \$1.26	\$1.26 \$1.26	33
LMR-SW540	50 5.8	0.610 [1]	1 100	88 2.2		PE 3	\$1.79 \$1.79	\$1.79 \$1.79	34
PE-1/2FAC	50 8.8	0.629 0.189[1]	1 120	88 2.2		PE 2.75	\$4.90 \$4.41	\$4.66 \$4.21	35
PE-1/2SFHC	50 10.2	0.519 0.141[1]	1 120	82 3.41	1,000	PE 0.6	\$4.87 \$4.38	\$4.63 \$4.19	36
PE-1/4SFHC	50 20.4	0.303 0.075[1]	1 120	82 5.85		PE 0.5	\$3.39 \$3.05	\$3.22 \$2.92	37
PE-B400	50 4	0.403 0.103[1]	2	6	190 600	PVC	\$2.18 \$1.96	\$2.07 \$1.87	38
PE-C100-LSZH	50 5.8	0.109 0.018[1]	2 90	66 25	40	LSZH 0.25	\$1.42 \$1.28	\$1.35 \$1.22	39
PE-C195	50 5.8	0.195 0.037[1]	2 90	80 11.7	135	PE 0.5	\$0.82 \$0.74	\$0.78 \$0.71	40
PE-C200	50 5.8	0.195 0.044[1]	2 90	83 10.8	170 1,000	PE	\$0.94 \$0.85	\$0.89 \$0.81	41
PE-C240	50 5.8	0.240 0.056[1]	2 90	84 7.98	250	PE 0.75	\$1.27 \$1.14	\$1.21 \$1.09	42
PE-C300	50 2.5	0.300 0.07[1]	2	85 6.3	350 2,000	PE 1.5	\$3.18 \$2.86	\$3.02 \$2.73	43
PE-C400	50 5.8	0.405 0.108[1]	2 90	85 4.1	480	PE	\$1.66 \$1.49	\$1.58 \$1.43	44
PE-C500	50 6	0.500 0.142[1]	2 90	86 3.5	720 3,000	PE	\$4.87 \$4.38	\$4.63 \$4.19	45
PE-C600	50 5.8	0.590 0.176[1]	2 90	87 2.7	900	PE	\$2.55 \$2.30	\$2.42 \$2.19	46
HIGH PERFORMANCE									
PE-151TC	50 27	0.151 0.025[1]	3 90	70 16.8	130	Polyurethane 0.75	Call Call	Call Call	47
PE-195TC	50 27	0.195 0.037[1]	3 90	70 12.2	522	FEP 1	Call Call	Call Call	48
PE-P047	50 20	0.056 0.011[1]	2 90	70 35	43	FEP 0.2	\$8.24 \$7.42	\$7.83 \$7.09	49
PE-P086	50 18	0.104 0.02[1]	2 110	70 21.7		FEP	\$8.33 \$7.50	\$7.91 \$7.16	50
PE-P086HF	50 40	0.104 0.02[1]	2	70 21.1		FEP 0.52	\$6.57 \$5.91	\$6.24 \$5.65	51
PE-P141	50 18	0.163 0.037[1]	2 110	70 11.2	600	FEP	\$11.80 \$10.62	\$11.21 \$10.15	52

Coaxial Cables

See Our Website For Current Pricing & Real-Time Stock Availability!

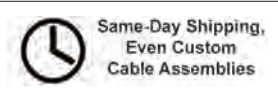

COAXIAL CABLES

Meets or Exceeds MIL-C-17 Specifications Where Applicable

MODEL NO.	COAX IMPEDANCE (Ohm)	JACKET DIAMETER (in)	NUMBER OF SHIELDS	VELOCITY FACTOR (%)	MAX. POWER HANDLING AT 1 GHz (W)	JACKET MATERIAL	PRICE PER FOOT		ROW
	MAXIMUM FREQUENCY (GHz.)	CONDUCTOR DIAM.(in) [strands]	RF SHIELDING (min dB)	ATTENUATION AT 1 GHz. (dB/100 ft)	MAXIMUM OPERATING VOLTAGE (V RMS)	MINIMUM BEND RADIUS (in)	1-99 FT 500-999 FT	100-499 FT 1000 + FT	
HIGH PERFORMANCE									
PE-P141HF	50	0.163	2	70		FEP	\$14.28	\$13.57	53
	31	0.037[1]		13			\$12.85	\$12.28	
PE-P195	50	0.195	3	70	650	FEP	\$10.42	\$9.90	54
	22	0.037[1]		12.5	1,900		\$9.38	\$8.96	
RG MIL-C-17 TYPE CABLE									
RG141A/U	50	0.190	1	70	650	PTFE (FG)	\$7.38	\$7.01	55
	10	0.037[1]		13	\$6.64		\$6.35		
RG142B/U	50	0.195	2	70	1,900	FEP	\$5.90	\$5.61	56
	8	0.037[1]		12.9			\$5.31	\$5.07	
RG174A/U	50	0.110	1	66	17	PVC	\$0.56	\$0.53	57
	1	0.019[7]		32	\$0.50		\$0.48		
RG178B/U	50	0.072	1	70	55	FEP	\$1.13	\$1.07	58
	3	0.012[7]		44.41	1,000		\$1.02	\$0.97	
RG180B/U	95	0.141	1	70	250	FEP	\$4.54	\$4.31	59
	3	0.012[7]			\$4.09		\$3.90		
RG188A/U	50	0.110	1	26	160	PTFE	\$2.67	\$2.54	60
	3	0.02[7]					\$2.40	\$2.30	
RG188-DS	50	0.118	2	30	160	PTFE	\$3.70	\$3.52	61
	10	0.02[7]					\$3.33	\$3.18	
RG196A/U	50	0.080	1	49	78	PTFE	\$1.49	\$1.42	62
	1	0.011[7]					\$1.34	\$1.28	
RG213/U	50	0.405	1	66	190	PVC	\$1.86	\$1.77	63
	1	0.09[7]		9	3,700		\$1.67	\$1.60	
RG214/U	50	0.425	2	66	170	PVC	\$8.01	\$7.61	64
	11	0.089[7]		7.32	5,000		\$7.21	\$6.89	
RG217/U	50	0.545	2	66	260	PVC	\$4.90	\$4.66	65
	1	0.106[1]		5.8	5,200		\$4.41	\$4.21	
RG218/U	50	0.870	1	66	600	PVC	\$12.67	\$12.04	66
	1	0.195[1]		5	11,000		\$11.40	\$10.90	
RG223/U	50	0.209	2	66	50	PVC	\$3.24	\$3.08	67
	12.4	0.035[1]		13.41	1,900		\$2.92	\$2.79	
RG225/U	50	0.430	2	70	1,700	PTFE (FG)	\$37.02	\$35.17	68
	10	0.094[7]		7.5	3,700		\$33.32	\$31.84	
RG303/U	50	0.170	1	14	650	FEP	\$6.88	\$6.54	69
	3	0.037[1]					\$6.19	\$5.92	
RG316/U	50	0.102	1	69	900	FEP	\$3.28	\$3.12	70
	3	0.02[7]		38			\$2.95	\$2.82	
RG316-DS	50	0.114	2	70	120	FEP	\$3.25	\$3.09	71
	3	0.02[7]		85	29		1,200	\$2.93	
RG393/U	50	0.390	2	70	1,700	FEP	\$16.88	\$16.04	72
	10	0.094[7]		7.5			\$15.19	\$14.52	
RG400/U	50	0.195	2	70	600	FEP	\$7.62	\$7.24	73
	12.4	[19]		14.7	1,900		\$6.86	\$6.55	
RG55B/U	53	0.202	2	66	53	PE	\$2.77	\$2.63	74
	3	0.032[1]		16.5			\$2.49	\$2.38	
RG58C/U	50	0.195	1	66	44	PVC (NC)	\$0.86	\$0.82	75
	5	0.036[19]		20	1,900		0.98	\$0.77	
RG58-P (1)	53	0.159	1	70	143	FEP	\$6.89	\$6.55	76
	1	0.032[1]		45	17.3		\$6.20	\$5.93	
RG62A/U	93	0.239	1	83	77	PVC	\$2.32	\$2.20	77
	1	0.025[1]		45	8.7		\$2.09	\$2.00	
RG8A/U	50	0.405	1	66	190	PVC (NC)	\$3.28	\$3.12	78
	1	0.085[7]		8			\$2.95	\$2.82	

Coaxial Cables

See Our Website For Current Pricing & Real-Time Stock Availability!

COAXIAL CABLES

Meets or Exceeds MIL-C-17 Specifications Where Applicable

MODEL NO.	COAX IMPEDANCE (Ohm)	JACKET DIAMETER (in)	NUMBER OF SHIELDS	VELOCITY FACTOR (%)	MAX. POWER HANDLING AT 1 GHz (W)	JACKET MATERIAL	PRICE PER FOOT		ROW
	MAXIMUM FREQUENCY (GHz.)	CONDUCTOR DIAM.(in) [strands]	RF SHIELDING (min dB)	ATTENUATION AT 1 GHz. (dB/100 ft)	MAXIMUM OPERATING VOLTAGE (V RMS)	MINIMUM BEND RADIUS (in)	1-99 FT 500-999 FT	100-499 FT 1000 + FT	
RG MIL-C-17 TYPE CABLE									
RG8X	50 1	0.242 0.056[19]	1	13.5	60 2,500	PVC (NC)	\$3.95 \$3.56	\$3.75 \$3.40	79
SEMIRIGID AND FORMABLE									
PE-020SR (8)	50 27	0.004[1]	1	85	2.9		\$21.12 \$19.01	\$20.06 \$18.16	80
PE-034SR (2,8)	50 40	0.008[1]	1	60	10		\$11.94 \$10.75	\$11.34 \$10.27	81
PE-047SR (3,8)	50 40	0.011[1]	1	40	32		\$10.74 \$9.67	\$10.20 \$9.24	82
PE-047SR-STRAIGHT	50 40	0.047 0.011[1]	1	40		0.05	\$11.58 \$10.42	\$11.00 \$9.96	83
PE-118SR (2)	50 46	0.032[1]	1	12.5	500 3,000	0.4	\$43.11 \$38.80	\$40.95 \$37.07	84
PE-SR047AL (3,6)	50 20	0.011[1]	1 90	70 41	32		\$9.88 \$8.89	\$9.39 \$8.50	85
PE-SR047AL-STRAIGHT	50 20	0.047 0.011[1]	1 90	70 41	1,000	0.05	\$10.85 \$9.77	\$10.31 \$9.33	86
PE-SR047FL (12)	50 20	0.011[1]	1	70 36	32		\$8.68 \$7.81	\$8.25 \$7.46	87
PE-SR401FL (11)	50 18	0.065[1]	1 100	70 6.8	279	0.75	\$16.97 \$15.27	\$16.12 \$14.59	88
PE-SR402-75 (3,8)	75 36	0.02[1]	1	12.5	280 3,500	0.1	\$10.88 \$9.79	\$10.34 \$9.36	89
PE-SR402-75-STRAIGHT	75 36	0.02[1]	1	12.5			\$10.85 \$9.77	\$10.31 \$9.33	90
PE-SR402AL (3,10)	50 36	0.036[1]	1	70 13	450		\$9.88 \$8.89	\$9.39 \$8.50	91
PE-SR402AL-STRAIGHT	50 36	0.141 0.036[1]	1	70 13		0.1	\$10.03 \$9.03	\$9.53 \$8.63	92
PE-SR402FL (4)	50 20	0.037[1]	110	70 12	400		\$8.40 \$7.56	\$7.98 \$7.22	93
PE-SR402FLJ (13)	50 34	0.161 0.036[1]	100	70 11.89	303.4 1,900	FEP 0.315	\$8.88 \$7.99	\$8.44 \$7.64	94
PE-SR402TN	50 36	0.036	1	70 12		1	\$6.74 \$6.07	\$6.40 \$5.80	95
PE-SR402TN-STRAIGHT	50 36	0.036	1	70 12		1	\$8.35 \$7.52	\$7.93 \$7.18	96
PE-SR405AL (3,9)	50 40	0.02[1]	1	23	130	0.05	\$9.24 \$8.32	\$8.78 \$7.95	97
PE-SR405AL-STRAIGHT	50 40	0.02[1]	1	23		0.05	\$9.24 \$8.32	\$8.78 \$7.95	98
PE-SR405FL (5)	50 20	0.02[1]	1	70 22.5	105		\$11.68 \$10.51	\$11.10 \$10.04	99
PE-SR405FLJ (14)	50 61	0.105 0.02[1]	1 100	70 19.5	121.5 1,500	FEP 0.5	\$8.96 \$8.06	\$8.51 \$7.71	1
PE-SR405TN	50 40	0.02[1]	1	22		0.05	\$6.37 \$5.73	\$6.05 \$5.48	2
PE-SR405TN-STRAIGHT	50 40	0.02[1]	1	22		0.05	\$6.98 \$6.28	\$6.63 \$6.00	3
PECX001	50 115	0.013[1]	1	77 30	101	0.125	\$11.60 \$10.44	\$11.02 \$9.98	4
PECX002	50 115	0.013[1]	1	77 30	101	0.125	\$15.48 \$13.93	\$14.71 \$13.31	5

Coaxial Cables

See Our Website For Current Pricing & Real-Time Stock Availability!

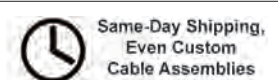

COAXIAL CABLES

Meets or Exceeds MIL-C-17 Specifications Where Applicable

MODEL NO.	COAX IMPEDANCE (Ohm)	JACKET DIAMETER (in)	NUMBER OF SHIELDS	VELOCITY FACTOR (%)	MAX. POWER HANDLING AT 1 GHz (W)	JACKET MATERIAL	PRICE PER FOOT		ROW
	MAXIMUM FREQUENCY (GHz.)	CONDUCTOR DIAM.(in) [strands]	RF SHIELDING (min dB)	ATTENUATION AT 1 GHz. (dB/100 ft)	MAXIMUM OPERATING VOLTAGE (V RMS)	MINIMUM BEND RADIUS (in)	1-99 FT 500-999 FT	100-499 FT 1000 + FT	
SEMRIGID AND FORMABLE									
PECX003	50	0.02[1]	1	77	188	0.25	\$18.46	\$17.54	6
	72						\$16.61	\$15.88	
PECX004	50	0.02[1]	1	77	188	0.25	\$20.78	\$19.74	7
	72						\$18.70	\$17.87	
PECX005	50	0.023[1]	1	77	314	0.25	\$8.46	\$8.04	8
	62						\$7.61	\$7.28	
PECX006	50	0.023[1]	1	77	231	0.25	\$10.77	\$10.23	9
	62						\$9.69	\$9.26	
PECX007	50	0.04[1]	1	77	580	0.5	\$12.06	\$11.46	10
	34						\$10.85	\$10.37	
PECX008	50	0.04[1]	1	77	580	0.5	\$14.39	\$13.67	11
	34						\$12.95	\$12.38	
RG401/U (2,8)	50	0.064[1]	1	70	1,400		\$23.06	\$21.91	12
	20			7.5	3,000		\$20.75	\$19.83	
RG402/U (3,8)	50	0.036[1]	1	70	450		\$7.60	\$7.22	13
	34			11.1			\$6.84	\$6.54	
RG402/U-STRAIGHT	50	0.036[1]	1	70	450		\$8.04	\$7.64	14
	33			12			\$7.24	\$6.91	
RG405/U (3,8)	50	0.02[1]	1	70	130		\$7.21	\$6.85	15
	40		-110	22			\$6.49	\$6.20	
RG405/U-STRAIGHT	50	0.02[1]	1	70	130		\$9.56	\$9.08	16
	40		-110	22			\$8.60	\$8.22	
SPP-250-LLPL	50	0.280	1	76	650	FEP	\$5.58	\$5.58	17
	5.8	0.068[1]	100	5.5		1.25	\$5.58	\$5.58	
TFT-402-LF	50	0.160	2	76		FEP	\$2.02	\$2.02	18
	5.8	0.037[1]	80			0.75	\$2.02	\$2.02	
TWINAX									
PE-S330 (TWINAX)	100	0.330	2			PVC	\$4.76	\$4.52	19
	0.4	0.037[7]			300		\$4.28	\$4.09	
RG108A/U (TWINAX)	78	0.235	1	66	30	PVC	\$2.67	\$2.54	20
	1	0.038[7]		34.6			\$2.40	\$2.30	

Coaxial Cables

See Our Website For Current Pricing & Real-Time Stock Availability!

NOTES:

- (1) P = PLENUM CABLE, NEC 725-2(b) CLASS 2 - **REQUIRES SPECIAL CONNECTORS**
- (2) SEMI-RIGID CABLE, SOLD IN 5 FEET, STRAIGHT PIECES ONLY
- (3) SEMI-RIGID CABLE, SOLD IN EITHER 5 FEET, STRAIGHT PIECES OR COILS OF 50 FEET
- (4) RE-SHAPEABLE VERSION OF RG402/U
- (5) RE-SHAPEABLE VERSION OF RG405/U
- (6) TINNED ALUMINUM VERSION OF PE-047SR
- (7) TINNED ALUMINUM VERSION OF RG401/U
- (8) BARE COPPER JACKET
- (9) TINNED ALUMINUM VERSION OF RG405/U
- (10) TINNED ALUMINUM VERSION OF RG402/U
- (11) RE-SHAPEABLE VERSION OF RG401/U
- (12) RE-SHAPEABLE VERSION OF PE-047SR
- (13) JACKETED RE-SHAPEABLE VERSION OF RG402/U
- (14) JACKETED RE-SHAPEABLE VERSION OF RG405/U

MATERIALS:

Al (Tn)	TIN PLATED ALUMINUM
Cu	BARE COPPER
Cu (Tn)	TIN PLATED COPPER
FEP	FLUORINATED ETHYLENE PROPYLENE
LSZH	LOW SMOKE ZERO HALOGEN
PE	POLYETHYLENE
PTFE	POLYTETRAFLUOROETHYLENE
PTFE (FR)	FIBERGLASS REINFORCED PTFE
PVC	POLYVINYLCHLORIDE
PVC (NC)	NON-CONTAMINATED PVC
PVC (FR)	FIBERGLASS REINFORCED PVC

Connector Selection Guide

3 Easy Ways to Find your Product.....

1. Search by PE Part Number

If you know the PE part number you are searching for, please reference our Part Number Index on Page [355](#)

2. Quick Reference Guide

(Page number refers to first appearance of product in the Connector Section)

Connector Series	Page	Connector Series	Page	Connector Series	Page	Connector Series	Page
1.0/2.3	205	75 Ohm N	262	FME	221	Rev. Pol. N	232
1.0mm	205	75 Ohm RCA	262	GR874	221	Rev. Pol. SMA	242
1.85mm	206	75 Ohm SMB	263	HN	221	Rev. Pol. TNC	256
10-32	212	75 Ohm SMB Positive Snap	264	LC	222	Rev. Thread SMA	242
2.4mm	207	75 Ohm SMC	265	MC-Card	222	SC	234
2.92mm	207	75 Ohm TNC	265	MCX	223	SHV	234
3.5mm	208	7mm	208	MHV	224	SMA	240
3/4"-20 Twinax	266	Banana	266	Mini SMP	225	SMB	244
4.1/9.5 Mini DIN	208	BMA	213	Mini UHF	225	SMC	246
4.3-10	209	BNC	216	MMBX	227	SMP	247
7/16 DIN	211	BNC Twinax	266	MMCX	226	SSMA	249
75 Ohm 1.0/2.3	257	C	218	N	231	SSMB	250
75 Ohm 1.6/5.6	257	D-Sub	219	NMO Mount	232	SSMC	251
75 Ohm BNC	259	D-Subminiature	257	QMA	233	TNC	254
75 Ohm F	260	Double Banana	266	QN	233	UHF	256
75 Ohm MCX	261	FAKRA	220	Rev. Pol. BNC	217	UMCX	256
75 Ohm Mini SMB	261			Rev. Pol. MCX	224		

3. Connector Locator

Connector Type	Page
1.0/2.3 Jack Connectors	
Right Angle, Bulkhead, Cable Connectors	205
Right Angle, PCB Mount	205
Straight, Bulkhead, Cable Connectors	205
Straight, Bulkhead, PCB Mount	205
Straight, PCB Mount	205
1.0/2.3 Plug Connectors	
Right Angle, Cable Connectors	205
Straight, Cable Connectors	205
1.0mm Female Connectors	
Straight, PCB Mount	205
1.85mm Female Connectors	
Straight, Bulkhead, Cable Connectors	206
Straight, Cable Connectors	206
Straight, PCB Mount	206
1.85mm Male Connectors	
Straight, Cable Connectors	205
Straight, PCB Mount	205
10-32 Female Connectors	
Right Angle, PCB Mount	212
Straight, Bulkhead, Cable Connectors	211
Straight, Bulkhead, Terminal	212
Straight, Cable Connectors	211

Connector Type	Page
Straight, PCB Mount	211
10-32 Male Connectors	
Right Angle, Cable Connectors	211
Straight, Cable Connectors	211
2.4mm Female Connectors	
Straight, 4 Hole Flange, Terminal	207
Straight, Bulkhead, Cable Connectors	206
Straight, Cable Connectors	206
Straight, PCB Mount	206
2.4mm Male Connectors	
Straight, 2 Hole Flange, Terminal	206
Straight, Cable Connectors	206
Straight, PCB Mount	206
2.92mm Female Connectors	
Straight, 2 Hole Flange, Field Replaceable Contact	207
Straight, Bulkhead, Cable Connectors	207
Straight, Cable Connectors	207
Straight, PCB Mount	207
2.92mm Male Connectors	
Straight, 2 Hole Flange, Field Replaceable Contact	207
Straight, Cable Connectors	207
Straight, PCB Mount	207
3.5mm Female Connectors	

Connector Locator

Connector Type	Page
Straight, Bulkhead, Cable Connectors	208
Straight, Cable Connectors	208
3.5mm Male Connectors	
Straight, Cable Connectors	208
4.1/9.5 Mini DIN Female Connectors	
Straight, Cable Connectors	208
4.1/9.5 Mini DIN Male Connectors	
Right Angle, Cable Connectors	208
Straight, Cable Connectors	208
4.3-10 Female Connectors	
Straight, 4 Hole Flange, Cable Connectors	209
Straight, 4 Hole Flange, Terminal	209
Straight, Cable Connectors	209
4.3-10 Male Connectors	
Right Angle, Cable Connectors	209
Straight, Cable Connectors	208
7/16 DIN Female Connectors	
Straight, 4 Hole Flange, Cable Connectors	211
Straight, 4 Hole Flange, Terminal	211
Straight, Bulkhead, Cable Connectors	210
Straight, Bulkhead, Terminal	211
Straight, Cable Connectors	210
7/16 DIN Male Connectors	
Right Angle, Cable Connectors	210
Straight, Cable Connectors	209
75 Ohm 1.0/2.3 Jack Connectors	
Right Angle, Bulkhead, PCB Mount	257
Straight, Bulkhead, PCB Mount	257
75 Ohm 1.0/2.3 Plug Connectors	
Straight, Cable Connectors	257
75 Ohm 1.6/5.6 Jack Connectors	
Right Angle, Bulkhead, Cable Connectors	257
Right Angle, PCB Mount	257
Straight, Bulkhead, Cable Connectors	257
Straight, Bulkhead, PCB Mount	257
75 Ohm 1.6/5.6 Plug Connectors	
Right Angle, Cable Connectors	257
Straight, Cable Connectors	257
75 Ohm BNC Female Connectors	
Right Angle, 4 Hole Flange, Terminal	259
Right Angle, Bulkhead, Terminal	259
Straight, 4 Hole Flange, Cable Connectors	259
Straight, 4 Hole Flange, Terminal	259
Straight, Bulkhead, Cable Connectors	259
Straight, Bulkhead, PCB Mount	259
Straight, Bulkhead, Terminal	259
Straight, Cable Connectors	258
Straight, PCB Mount	258
75 Ohm BNC Male Connectors	
Right Angle, Cable Connectors	258
Straight, 4 Hole Flange, Terminal	258
Straight, Bulkhead, Terminal	258
Straight, Cable Connectors	258

Connector Type	Page
75 Ohm F Female Connectors	
Right Angle, Bulkhead, PCB Mount	260
Right Angle, PCB Mount	260
Straight, 4 Hole Flange, Terminal	260
Straight, Bulkhead, Cable Connectors	260
Straight, Bulkhead, PCB Mount	260
Straight, Bulkhead, Terminal	260
Straight, PCB Mount	260
Straight, Thread-In, Terminal	260
75 Ohm F Male Connectors	
Right Angle, Cable Connectors	260
Straight, Cable Connectors	259
75 Ohm MCX Jack Connectors	
Right Angle, PCB Mount	261
Straight, Cable Connectors	261
Straight, PCB Mount	261
75 Ohm MCX Plug Connectors	
Right Angle, Cable Connectors	261
Straight, Cable Connectors	260
Straight, PCB Mount	260
75 Ohm Mini SMB Jack Connectors	
Right Angle, Bulkhead, PCB Mount	261
Right Angle, PCB Mount	261
Straight, 2 Hole Flange, Terminal	261
Straight, Bulkhead, PCB Mount	261
Straight, Cable Connectors	261
Straight, PCB Mount	261
75 Ohm Mini SMB Plug Connectors	
Right Angle, Cable Connectors	261
Straight, Cable Connectors	261
75 Ohm N Female Connectors	
Straight, 4 Hole Flange, Terminal	262
Straight, Bulkhead, Terminal	262
Straight, Cable Connectors	262
75 Ohm N Male Connectors	
Right Angle, Cable Connectors	262
Straight, 4 Hole Flange, Terminal	262
Straight, Cable Connectors	262
75 Ohm RCA Female Connectors	
Straight, Bulkhead, Cable Connectors	262
75 Ohm RCA Male Connectors	
Right Angle, Cable Connectors	262
Straight, Cable Connectors	262
75 Ohm SMB Jack Connectors	
Right Angle, Bulkhead, Terminal	263
Right Angle, PCB Mount	263
Straight, Bulkhead, Cable Connectors	263
Straight, Bulkhead, Terminal	263
Straight, Cable Connectors	263
Straight, PCB Mount	263
75 Ohm SMB Plug Connectors	
Right Angle, Cable Connectors	263
Right Angle, PCB Mount	263

Connector Locator

Connector Type	Page
Straight, Bulkhead, Terminal	263
Straight, Cable Connectors	263
Straight, PCB Mount	263
75 Ohm SMB Positive Snap Plug Connectors	
Right Angle, Cable Connectors	264
Straight, Cable Connectors	264
75 Ohm SMC Jack Connectors	
Right Angle, PCB Mount	265
Straight, Bulkhead, Cable Connectors	264
Straight, Bulkhead, Terminal	264
Straight, Cable Connectors	264
Straight, PCB Mount	264
75 Ohm SMC Plug Connectors	
Right Angle, Cable Connectors	264
Right Angle, PCB Mount	264
Straight, Bulkhead, Terminal	264
Straight, Cable Connectors	264
75 Ohm TNC Female Connectors	
Straight, 4 Hole Flange, Terminal	265
Straight, Bulkhead, Cable Connectors	265
Straight, Bulkhead, Terminal	265
75 Ohm TNC Male Connectors	
Right Angle, Cable Connectors	265
Straight, Cable Connectors	265
78 Ohm BNC Twinax Jack Connectors	
Right Angle, PCB Mount	266
Straight, 4 Hole Flange, Terminal	266
Straight, Bulkhead, Cable Connectors	266
Straight, Bulkhead, Terminal	266
Straight, Cable Connectors	265
Straight, PCB Mount	265
78 Ohm BNC Twinax Plug Connectors	
Straight, Cable Connectors	265
7mm Sexless Connectors	
Straight, Cable Connectors	208
95 Ohm 3/4"-20 Twinax Female Connectors	
Straight, 4 Hole Flange, Terminal	266
Straight, Bulkhead, Terminal	266
Straight, Cable Connectors	266
95 Ohm 3/4"-20 Twinax Male Connectors	
Straight, Cable Connectors	266
Banana Plug Connectors	
Straight, Cable Connectors	266
BMA Jack Connectors	
Right Angle, 2 Hole Flange, Cable Connectors	213
Straight, 2 Hole Flange, Cable Connectors	213
Straight, 2 Hole Flange, Terminal	213
Straight, 4 Hole Flange, Terminal	213
Straight, Bulkhead, Cable Connectors	213
Straight, Cable Connectors	212
Straight, PCB Mount	213
Straight, Terminal	213
Straight, Thread-In, Terminal	213

Connector Type	Page
BMA Plug Connectors	
Right Angle, PCB Mount	212
Straight, 2 Hole Flange, Field Replaceable Contact	212
Straight, 2 Hole Flange, Terminal	212
Straight, 4 Hole Flange, Terminal	212
Straight, Bulkhead, Cable Connectors	212
Straight, PCB Mount	212
Straight, Thread-In, Terminal	212
BNC Female Connectors	
Right Angle, 4 Hole Flange, Terminal	216
Right Angle, Bulkhead, Terminal	216
Straight, 4 Hole Flange, Cable Connectors	216
Straight, 4 Hole Flange, Terminal	216
Straight, Bulkhead, Cable Connectors	215
Straight, Bulkhead, PCB Mount	215
Straight, Bulkhead, Terminal	215
Straight, Cable Connectors	215
Straight, PCB Mount	215
BNC Male Connectors	
Right Angle, Cable Connectors	214
Straight, 4 Hole Flange, Terminal	214
Straight, Bulkhead, Terminal	214
Straight, Cable Connectors	213
C Female Connectors	
Straight, 4 Hole Flange, Cable Connectors	218
Straight, 4 Hole Flange, Terminal	218
Straight, Bulkhead, Cable Connectors	218
Straight, Bulkhead, Terminal	218
Straight, Cable Connectors	218
C Male Connectors	
Right Angle, Cable Connectors	218
Straight, 4 Hole Flange, Terminal	218
Straight, Cable Connectors	217
D-Sub Plug Connectors	
Right Angle, Cable Connectors	219
Straight, Cable Connectors	219
D-Sub Receptacle Connectors	
Right Angle, Cable Connectors	219
Straight, Cable Connectors	219
D-Subminiature Plug Connectors	
Right Angle, Cable Connectors	257
D-Subminiature Receptacle Connectors	
Right Angle, Cable Connectors	257
Double Banana Plug Connectors	
Straight, Cable Connectors	266
FAKRA Jack Connectors	
Right Angle, Cable Connectors	220
Right Angle, PCB Mount	220
Straight, Cable Connectors	220
FAKRA Plug Connectors	
Right Angle, PCB Mount	220
Straight, Cable Connectors	219
Straight, PCB Mount	219

Connector Locator

Connector Type	Page
FME Jack Connectors	
Straight, Cable Connectors	221
FME Plug Connectors	
Straight, Bulkhead, Terminal	220
Straight, Cable Connectors	220
GR874 Sexless Connectors	
Straight, Cable Connectors	221
HN Female Connectors	
Straight, 4 Hole Flange, Terminal	221
Straight, Bulkhead, Terminal	221
Straight, Cable Connectors	221
HN Male Connectors	
Right Angle, Cable Connectors	221
Straight, Cable Connectors	221
LC Female Connectors	
Straight, 4 Hole Flange, Terminal	222
Straight, Cable Connectors	222
LC Male Connectors	
Right Angle, Cable Connectors	222
Straight, Cable Connectors	222
MC-Card Plug Connectors	
Right Angle, Cable Connectors	222
Straight, Cable Connectors	222
MCX Jack Connectors	
Right Angle, Bulkhead, Terminal	223
Right Angle, PCB Mount	223
Straight, 2 Hole Flange, Terminal	223
Straight, Bulkhead, Cable Connectors	223
Straight, Bulkhead, Terminal	223
Straight, Cable Connectors	223
Straight, PCB Mount	223
MCX Plug Connectors	
Right Angle, Cable Connectors	222
Right Angle, PCB Mount	223
Straight, Cable Connectors	222
Straight, PCB Mount	222
MHV Female Connectors	
Straight, 4 Hole Flange, Cable Connectors	224
Straight, 4 Hole Flange, Terminal	224
Straight, Bulkhead, Cable Connectors	224
Straight, Bulkhead, Terminal	224
Straight, Cable Connectors	224
MHV Male Connectors	
Right Angle, Cable Connectors	224
Straight, Cable Connectors	224
Mini SMP Female Connectors	
Right Angle, Cable Connectors	225
Straight, Cable Connectors	225
Mini SMP Male Connectors	
Right Angle, PCB Mount	225
Straight, PCB Mount	225
Straight, Solder, Terminal	225
Mini UHF Female Connectors	

Connector Type	Page
Straight, 4 Hole Flange, Terminal	225
Straight, Bulkhead, Cable Connectors	225
Straight, Bulkhead, PCB Mount	225
Straight, Bulkhead, Terminal	225
Straight, Cable Connectors	225
Mini UHF Male Connectors	
Straight, Cable Connectors	225
MMBX Jack Connectors	
Straight, PCB Mount	227
Straight, Thread-In, Terminal	227
MMBX Plug Connectors	
Right Angle, Cable Connectors	226
Straight, Cable Connectors	226
Straight, PCB Mount	226
MMCX Jack Connectors	
Right Angle, PCB Mount	226
Straight, Cable Connectors	226
Straight, PCB Mount	226
MMCX Plug Connectors	
Right Angle, Cable Connectors	226
Straight, Cable Connectors	226
Straight, PCB Mount	226
N Female Connectors	
Right Angle, 4 Hole Flange, Terminal	231
Right Angle, Bulkhead, PCB Mount	231
Straight, 2 Hole Flange, Terminal	231
Straight, 4 Hole Flange, Cable Connectors	231
Straight, 4 Hole Flange, Terminal	231
Straight, Bulkhead, Cable Connectors	230
Straight, Bulkhead, PCB Mount	231
Straight, Bulkhead, Terminal	230
Straight, Cable Connectors	229
Straight, PCB Mount	230
Straight, Press-In, Terminal	231
N Male Connectors	
Right Angle, Cable Connectors	228
Straight, 4 Hole Flange, Terminal	228
Straight, Bulkhead, Terminal	228
Straight, Cable Connectors	227
NMO Mount Sexless Connectors	
Straight, Cable Connectors	232
QMA Female Connectors	
Right Angle, PCB Mount	233
Straight, Bulkhead, Cable Connectors	233
Straight, Cable Connectors	233
Straight, PCB Mount	233
QMA Male Connectors	
Right Angle, Cable Connectors	232
Straight, Cable Connectors	232
QN Female Connectors	
Straight, 4 Hole Flange, Terminal	233
Straight, Bulkhead, Cable Connectors	233
QN Male Connectors	

Connector Locator

Connector Type	Page
Right Angle, Cable Connectors	233
Straight, Cable Connectors	233
Reverse Polarity BNC Female Connectors	
Right Angle, 4 Hole Flange, Terminal	217
Right Angle, Bulkhead, Terminal	217
Straight, 4 Hole Flange, Cable Connectors	217
Straight, 4 Hole Flange, Terminal	217
Straight, Bulkhead, Cable Connectors	217
Straight, Bulkhead, Terminal	217
Straight, Cable Connectors	217
Reverse Polarity BNC Male Connectors	
Right Angle, Cable Connectors	216
Straight, 4 Hole Flange, Terminal	216
Straight, Cable Connectors	216
Reverse Polarity MCX Jack Connectors	
Right Angle, Bulkhead, PCB Mount	224
Straight, Bulkhead, Cable Connectors	223
Straight, Bulkhead, PCB Mount	223
Reverse Polarity MCX Plug Connectors	
Right Angle, Cable Connectors	223
Straight, Cable Connectors	223
Reverse Polarity N Female Connectors	
Straight, Cable Connectors	232
Reverse Polarity N Male Connectors	
Straight, Cable Connectors	232
Reverse Polarity SMA Female Connectors	
Right Angle, Bulkhead, PCB Mount	242
Right Angle, PCB Mount	242
Straight, 2 Hole Flange, Terminal	241
Straight, 4 Hole Flange, Terminal	242
Straight, Bulkhead, Cable Connectors	241
Straight, Bulkhead, PCB Mount	241
Straight, Bulkhead, Terminal	241
Straight, Cable Connectors	241
Straight, PCB Mount	241
Reverse Polarity SMA Male Connectors	
Right Angle, Cable Connectors	240
Straight, Cable Connectors	240
Reverse Polarity TNC Female Connectors	
Right Angle, Bulkhead, PCB Mount	256
Straight, 4 Hole Flange, Terminal	256
Straight, Bulkhead, Cable Connectors	255
Straight, Bulkhead, Terminal	255
Straight, Cable Connectors	255
Reverse Polarity TNC Male Connectors	
Right Angle, Cable Connectors	255
Straight, 4 Hole Flange, Terminal	255
Straight, Cable Connectors	254
Reverse Thread SMA Female Connectors	
Right Angle, PCB Mount	242
Straight, 4 Hole Flange, Terminal	242
Straight, Bulkhead, Cable Connectors	242
Straight, Cable Connectors	242







Connector Type	Page
Straight, PCB Mount	242
Reverse Thread SMA Male Connectors	
Right Angle, Cable Connectors	242
Straight, Cable Connectors	242
SC Female Connectors	
Straight, 4 Hole Flange, Terminal	234
Straight, Bulkhead, Terminal	234
SC Male Connectors	
Right Angle, Cable Connectors	234
Straight, Cable Connectors	234
SHV Jack Connectors	
Straight, 4 Hole Flange, Terminal	234
Straight, Bulkhead, Cable Connectors	234
Straight, Bulkhead, Terminal	234
SHV Plug Connectors	
Straight, Bulkhead, Terminal	234
Straight, Cable Connectors	234
SMA Female Connectors	
Right Angle, 2 Hole Flange, Terminal	240
Right Angle, 4 Hole Flange, Field Replaceable Contact	240
Right Angle, 4 Hole Flange, Terminal	240
Right Angle, Bulkhead, PCB Mount	240
Right Angle, Bulkhead, Terminal	240
Right Angle, PCB Mount	240
Straight, 2 Hole Flange, Cable Connectors	239
Straight, 2 Hole Flange, Field Replaceable Contact	239
Straight, 2 Hole Flange, Terminal	239
Straight, 4 Hole Flange, Cable Connectors	239
Straight, 4 Hole Flange, Field Replaceable Contact	239
Straight, 4 Hole Flange, Terminal	239
Straight, Bulkhead, Cable Connectors	238
Straight, Bulkhead, PCB Mount	238
Straight, Bulkhead, Terminal	238
Straight, Cable Connectors	237
Straight, PCB Mount	237
Straight, Press-In, Terminal	240
SMA Male Connectors	
Right Angle, Cable Connectors	236
Right Angle, PCB Mount	237
Straight, 2 Hole Flange, Field Replaceable Contact	236
Straight, 2 Hole Flange, Terminal	236
Straight, 4 Hole Flange, Field Replaceable Contact	236
Straight, 4 Hole Flange, Terminal	236
Straight, Bulkhead, Terminal	236
Straight, Cable Connectors	235
Straight, PCB Mount	235
SMB Jack Connectors	
Right Angle, Bulkhead, PCB Mount	244
Right Angle, Bulkhead, Terminal	244
Right Angle, PCB Mount	244
Straight, 2 Hole Flange, Terminal	244
Straight, 4 Hole Flange, Terminal	244
Straight, Bulkhead, Cable Connectors	244

Connector Locator

Connector Type	Page
Straight, Bulkhead, PCB Mount	244
Straight, Bulkhead, Terminal	244
Straight, Cable Connectors	243
Straight, PCB Mount	243
SMB Plug Connectors	
Right Angle, Cable Connectors	243
Right Angle, PCB Mount	243
Straight, Bulkhead, Terminal	243
Straight, Cable Connectors	243
Straight, PCB Mount	243
SMC Jack Connectors	
Right Angle, Bulkhead, PCB Mount	246
Right Angle, Bulkhead, Terminal	245
Right Angle, PCB Mount	245
Straight, 4 Hole Flange, Terminal	245
Straight, Bulkhead, Cable Connectors	245
Straight, Bulkhead, PCB Mount	245
Straight, Bulkhead, Terminal	245
Straight, Cable Connectors	245
Straight, PCB Mount	245
SMC Plug Connectors	
Right Angle, Cable Connectors	245
Right Angle, PCB Mount	245
Straight, Cable Connectors	244
Straight, PCB Mount	244
SMP Female Connectors	
Right Angle, Cable Connectors	247
Straight, Cable Connectors	247
Straight, PCB Mount	247
SMP Male Connectors	
Right Angle, PCB Mount	247
Straight, 2 Hole Flange, Cable Connectors	246
Straight, 2 Hole Flange, Shroud	246
Straight, 2 Hole Flange, Terminal	247
Straight, Bulkhead, Cable Connectors	246
Straight, PCB Mount	246
Straight, Press-In, Shroud	247
Straight, Solder, Shroud	247
Straight, Solder, Terminal	247
Straight, Terminal	246
Straight, Thread-In, Shroud	247
Straight, Thread-In, Terminal	247
SSMA Female Connectors	
Right Angle, PCB Mount	249
Straight, 2 Hole Flange, Cable Connectors	249
Straight, 2 Hole Flange, Terminal	249
Straight, 4 Hole Flange, Cable Connectors	249
Straight, 4 Hole Flange, Terminal	249
Straight, Bulkhead, Cable Connectors	249
Straight, Bulkhead, PCB Mount	249
Straight, Bulkhead, Terminal	249
Straight, Cable Connectors	248
Straight, PCB Mount	249

Connector Type	Page
SSMA Male Connectors	
Right Angle, Cable Connectors	248
Straight, 2 Hole Flange, Terminal	248
Straight, 4 Hole Flange, Terminal	248
Straight, Cable Connectors	248
Straight, PCB Mount	248
SSMB Jack Connectors	
Right Angle, PCB Mount	250
Straight, 4 Hole Flange, Terminal	250
Straight, Bulkhead, Cable Connectors	250
Straight, Bulkhead, Terminal	250
Straight, PCB Mount	250
SSMB Plug Connectors	
Right Angle, Cable Connectors	250
Straight, Cable Connectors	249
SSMC Jack Connectors	
Right Angle, Bulkhead, Cable Connectors	251
Right Angle, Bulkhead, PCB Mount	251
Right Angle, Bulkhead, Terminal	251
Right Angle, PCB Mount	251
Straight, 2 Hole Flange, Terminal	251
Straight, 4 Hole Flange, Terminal	251
Straight, Bulkhead, Cable Connectors	250
Straight, Bulkhead, Terminal	251
Straight, PCB Mount	250
SSMC Plug Connectors	
Right Angle, Cable Connectors	250
Right Angle, PCB Mount	250
Straight, Cable Connectors	250
TNC Female Connectors	
Right Angle, Bulkhead, Cable Connectors	254
Right Angle, Bulkhead, PCB Mount	254
Right Angle, Bulkhead, Terminal	254
Right Angle, PCB Mount	254
Straight, 4 Hole Flange, Cable Connectors	253
Straight, 4 Hole Flange, Terminal	254
Straight, Bulkhead, Cable Connectors	253
Straight, Bulkhead, PCB Mount	253
Straight, Bulkhead, Terminal	253
Straight, Cable Connectors	252
TNC Male Connectors	
Right Angle, Cable Connectors	252
Straight, 4 Hole Flange, Terminal	252
Straight, Cable Connectors	251
UHF Female Connectors	
Straight, 4 Hole Flange, Terminal	256
Straight, Bulkhead, Terminal	256
Straight, Cable Connectors	256
UHF Male Connectors	
Straight, Cable Connectors	256
UHF Sexless Connectors	
Straight, Cable Connectors	256
UMCX Jack Connectors	
Straight, PCB Mount	256



1.0/2.3 Connectors

Connection Method	Product Image	Attachment Cable/Contact	Coax Type / Termination Type	Model No.	PRICE				ROW
					1-24	25-49	50-99	100 +	
Plug									
Cable Connectors		Crimp/Solder	RG55, RG142, RG223, RG400	PE44242	\$12.79	\$12.15	\$11.51	\$11.00	1
			RG58, RG303, RG141, PE-C195, PE-P195, LMR-195, .195 inch	PE44243	\$14.72	\$13.98	\$13.25	\$12.66	2
			RG174, RG316, RG188, LMR-100, PE-B100, PE-C100, .100 inch	PE44244	\$14.03	\$13.33	\$12.63	\$12.07	3
			RG188-DS, RG316-DS	PE45166	\$11.58	\$11.00	\$10.42	\$9.96	4
Plug Right Angle									
Cable Connectors		Crimp/Solder	RG55, RG142, RG223, RG400	PE44247	\$15.03	\$14.28	\$13.53	\$12.93	5
			RG58, RG303, RG141, PE-C195, PE-P195, LMR-195, .195 inch	PE44248	\$16.57	\$15.74	\$14.91	\$14.25	6
			RG174, RG316, RG188, LMR-100, PE-B100, PE-C100, .100 inch	PE44249	\$14.28	\$13.57	\$12.85	\$12.28	7
			RG316-DS, RG188-DS	PE44783	\$16.14	\$15.33	\$14.53	\$13.88	8
Jack									
PCB Mount		Solder	Thru Hole with .200 inch x .055 inch Hole Spacing	PE44257	\$10.20	\$9.69	\$9.18	\$8.77	9
Jack, Bulkhead Mount									
Cable Connectors		Crimp/Solder	.100 inch, RG316, RG174, RG188, LMR-100, LMR-100A, LMR-100A-FR, PE-C100, PE-B100 with .217 inch DD Hole	PE44254	\$16.46	\$15.64	\$14.81	\$14.16	10
			Solder/Solder	PE-SR402AL, PE-SR402FL, RG402 with .235 inch D Hole	PE44255	\$21.53	\$20.45	\$19.38	\$18.52
		PE-SR405AL, PE-SR405FL, RG405 with .235 inch D Hole		PE44256	\$18.23	\$17.32	\$16.41	\$15.68	12
PCB Mount		Solder	Thru Hole with .220 inch Diameter	PE44259	\$12.59	\$11.96	\$11.33	\$10.83	13
Jack Right Angle									
PCB Mount		Solder	Thru Hole with .200 inch x .055 inch Hole Spacing	PE44258	\$12.84	\$12.20	\$11.56	\$11.04	14
Jack Right Angle, Bulkhead Mount									
Cable Connectors		Crimp/Solder	RG58 with .236 inch DD Hole	PE44260	\$15.74	\$14.95	\$14.17	\$13.54	15
			RG174, RG316, RG188 with .236 inch DD Hole	PE44261	\$15.74	\$14.95	\$14.17	\$13.54	16

1.0mm Connectors

Connection Method	Product Image	Attachment Cable/Contact	Coax Type / Termination Type	Model No.	PRICE				ROW
					1-1	2-4	5-9	10 +	
Female									
PCB Mount		Clamp/Solder (Captive Contact)	End Launch	PE45403	\$1,078.76	\$1,041.00	\$1,003.25	\$970.88	17

1.85mm Connectors





Connection Method	Product Image	Attachment Cable/Contact	Coax Type / Termination Type	Model No.	PRICE				ROW
					1 Pc.	See Web for Volume Pricing			
Male									
Cable Connectors		Clamp/Solder	PE-047SR, PE-SR047AL, PE-SR047FL	PE44799	\$122.04	See Web for Volume Pricing			18
			PE-P086, PE-P086LL	PE45005	\$89.47				19
PCB Mount		Clamp/Solder (Captive Contact)	End Launch	PE45517	\$290.18				20
			End Launch	PE45518	\$273.93				21

* Fits MIL-C-17 and equivalent cable versions only









Connectors

See Our Website For Current Pricing & Real-Time Stock Availability!

1.85mm Connectors

Connection Method	Product Image	Attachment Cable/Contact	Coax Type / Termination Type	Model No.	PRICE			ROW
					1 Pc.	See Web for Volume Pricing		
Cable Connectors		Solder	PE-SR405AL, PE-SR405FL, PE-SR405FLJ, PE-SR405TN, RG405	PE44336	\$151.23			22
			PE-047SR, PE-SR047AL, PE-SR047FL	PE45410	\$89.31			23
			PE-SR405AL, RG405, PE-SR405FLJ	PE45413	\$92.79			24
			PECX001, PECX002	PE45482	\$113.51			25
			PECX003, PECX004	PE45484	\$113.51			26
Female								
Cable Connectors		Clamp/Solder	PE-047SR, PE-SR047AL, PE-SR047FL	PE44800	\$137.81		See Web for Volume Pricing	27
PCB Mount		Clamp/Solder (Captive Contact)	End Launch	PE45402	\$236.94			28
			End Launch	PE45477	\$173.53			29
			End Launch	PE45515	\$258.93			30
			End Launch	PE45516	\$253.57		31	
Female, Bulkhead Mount								
Cable Connectors		Clamp/Solder	PE-SR405AL, PE-SR405FL, PE-SR405FLJ, PE-SR405TN, RG405 with .252 inch D Hole	PE44802	\$130.43			32

2.4mm Connectors

Connection Method	Product Image	Attachment Cable/Contact	Coax Type / Termination Type	Model No.	PRICE			ROW
					1 Pc.	See Web for Volume Pricing		
Male								
PCB Mount		Clamp	Vertical Launch	PE45456	\$47.61			33
			Vertical Launch	PE45457	\$47.61			34
Cable Connectors		Clamp/Solder	PE-SR405AL, PE-SR405FL, PE-SR405FLJ, PE-SR405TN, RG405	PE44345	Call		See Web for Volume Pricing	35
PCB Mount		Clamp/Solder (Captive Contact)	End Launch	PE45513	\$212.14			36
			End Launch	PE45514	\$175.36			37
Cable Connectors		Solder	PE-SR405AL, PE-SR405FL, RG405	PE44215	\$65.23			38
			PE-047SR, PE-SR047AL, PE-SR047FL	PE45411	\$85.06		39	
			PE-SR405AL, RG405, PE-SR405FLJ	PE45414	\$85.06		40	
Male, 2 Hole Flange Mount								
Terminal		Solder	Pin with .481 inch Hole Spacing	PE44220	\$161.80			41
Female								
PCB Mount		Clamp	Vertical Launch	PE45454	\$44.50			42
			Vertical Launch	PE45455	\$44.50			43
Cable Connectors		Clamp/Solder	PE-SR405AL, PE-SR405FL, PE-SR405FLJ, PE-SR405TN, RG405	PE44216	\$190.20		See Web for Volume Pricing	44
PCB Mount		Clamp/Solder (Captive Contact)	End Launch	PE45401	\$176.47			45
			End Launch	PE45472	\$94.53			46
			End Launch	PE45473	\$90.98			47
			End Launch	PE45474	\$90.98			48
			End Launch	PE45475	\$90.98			49
			End Launch	PE45476	\$94.53			50
End Launch	PE45511	\$191.48		51				
End Launch	PE45512	\$216.79		52				
Female, Bulkhead Mount								
Cable Connectors		Clamp/Solder	PE-SR405AL, PE-SR405FL, PE-SR405FLJ, PE-SR405TN, RG405 with .252 inch D Hole	PE44801	\$137.81			53

* Fits MIL-C-17 and equivalent cable versions only











Connectors

See Our Website For Current Pricing & Real-Time Stock Availability!

2.4mm Connectors

Connection Method	Product Image	Attachment Cable/Contact	Coax Type / Termination Type	Model No.	PRICE			ROW
					1 Pc.	See Web for Volume Pricing		
Female, 4 Hole Flange Mount								
Terminal		Solder	Pin with .340 inch Hole Spacing	PE44218	\$145.48			54

2.92mm Connectors





Connection Method	Product Image	Attachment Cable/Contact	Coax Type / Termination Type	Model No.	PRICE			ROW
					1 Pc.	See Web for Volume Pricing		
Male								
PCB Mount		Clamp	Vertical Launch	PE45452	\$44.37	See Web for Volume Pricing		55
			Vertical Launch	PE45453	\$44.37			56
Cable Connectors		Clamp/Solder	PE-SR405AL, PE-SR405FL, PE-SR405FLJ, PE-SR405TN, RG405	PE44796	\$67.38			57
			PE-SR047FL, PE-SR047AL, PE-047SR	PE44797	\$111.40			58
PCB Mount		Clamp/Solder (Captive Contact)	End Launch	PE45509	\$185.91			59
			End Launch	PE45510	\$175.36			60
Cable Connectors		Solder	PE-047SR, PE-SR047AL, PE-SR047FL	PE45412	\$77.34			61
			PE-SR405AL, RG405, PE-SR405FLJ	PE45415	\$77.34			62
			PECX001, PECX002	PE45483	\$106.07	63		
			PECX005, PECX006	PE45485	\$106.07	64		
			PE-118SR, 0.118 inch	PE45486	\$110.21	65		
			PE-120SRLL, Tinned 120LL	PE45487	\$106.07	66		
			PE-SR402AL, PE-SR402FL, PE-SR402FLJ, PE-SR402TN, RG402	PE4987	\$50.39	67		
PE-SR405AL, PE-SR405FL, RG405	PE4988	\$48.76	68					
Male, 2 Hole Flange Mount								
Field Replaceable		Field Replaceable	.012 inch Pin with .481 inch Hole Spacing	PE44232	\$70.30			69
Female								
PCB Mount		Clamp	Vertical Launch	PE45450	\$41.46	See Web for Volume Pricing		70
			Vertical Launch	PE45451	\$41.46			71
Cable Connectors		Clamp/Solder	PE-SR402AL, PE-SR402FL, RG402	PE44227	\$125.89			72
			PE-047SR, PE-SR047AL, PE-SR047FL	PE44798	\$126.64			73
PCB Mount		Clamp/Solder (Captive Contact)	End Launch	PE45400	\$156.64			74
			End Launch	PE45467	\$69.97			75
			End Launch	PE45468	\$69.97			76
			End Launch	PE45469	\$69.97			77
			End Launch	PE45470	\$69.97	78		
			End Launch	PE45471	\$67.34	79		
			End Launch	PE45507	\$169.21	80		
End Launch	PE45508	\$159.64	81					
Female, Bulkhead Mount								
Cable Connectors		Clamp/Solder	PE-SR405AL, PE-SR405FL, PE-SR405FLJ, PE-SR405TN, RG405 with .235 inch D Hole	PE4992	\$161.80			82
Female, 2 Hole Flange Mount								
Field Replaceable		Field Replaceable	.012 inch Pin with .481 inch Hole Spacing	PE44229	\$133.55			83

Connectors

See Our Website For Current Pricing & Real-Time Stock Availability!

* Fits MIL-C-17 and equivalent cable versions only



3.5mm Connectors

Connection Method	Product Image	Attachment Cable/Contact	Coax Type / Termination Type	Model No.	PRICE				ROW	
					1 Pc.	See Web for Volume Pricing				
Male										
Cable Connectors		Threaded	VNA Test Cable	PE44487	\$686.25	See Web for Volume Pricing			84	
		Clamp/Solder	PE-SR402AL, PE-SR402FL, PE-SR402FLJ, PE-SR402TN, RG402	PE4981	\$91.62					85
			PE-SR405AL, PE-SR405FL, PE-SR405FLJ, PE-SR405TN, RG405	PE4982	\$99.61					
Female										
Cable Connectors		Clamp/Solder	PE-SR402AL, PE-SR402FL, PE-SR402FLJ, PE-SR402TN, RG402	PE45011	\$97.48				87	
Female, Bulkhead Mount										
Cable Connectors		Clamp/Solder	PE-SR402AL, PE-SR402FL, RG402 with .235 inch D Hole	PE4985	\$272.81				88	



7mm Connectors

Connection Method	Product Image	Attachment Cable/Contact	Coax Type / Termination Type	Model No.	PRICE				ROW
					1-9	10-24	25-49	50 +	
Sexless									
Cable Connectors		Threaded	VNA Test Cable	PE44484	\$450.42	\$427.90	\$405.38	\$387.36	89

4.1/9.5 Mini DIN Connectors

Connection Method	Product Image	Attachment Cable/Contact	Coax Type / Termination Type	Model No.	PRICE				ROW
					1-24	25-49	50-99	100 +	
Male									
Cable Connectors		Solder/Solder	SPP-250-LLPL	PE45421	\$27.80	\$26.41	\$25.02	\$23.91	90
Male Right Angle									
Cable Connectors		Solder/Solder	SPP-250-LLPL	PE45422	\$38.22	\$36.31	\$34.40	\$32.87	91
			SPP-250-LLPL	TC-SPP250-4195M-RALP	\$18.40	\$18.40	\$18.40	\$18.40	92
Female									
Cable Connectors		Solder/Solder	SPP-250-LLPL	PE45420	\$31.26	\$29.70	\$28.13	\$26.88	93

4.3-10 Connectors







Connection Method	Product Image	Attachment Cable/Contact	Coax Type / Termination Type	Model No.	PRICE				ROW
					1-24	25-49	50-99	100 +	
Male									
Cable Connectors		Crimp/Solder	LMR-240	TC-240-4310M-X	\$19.54	\$19.54	\$19.54	\$19.54	94
			LMR-400	TC-400-4310M-X	\$20.08	\$20.08	\$20.08	\$20.08	95
			LMR-600	TC-600-4310M-X	\$21.71	\$21.71	\$21.71	\$21.71	96
		Clamp/Solder	RG213, RG8, RG225, RG214, RG393	PE45295	\$43.27	\$41.11	\$38.94	\$37.21	97
			RG213, RG8, RG225, RG214, RG393	PE45296	\$66.39	\$63.07	\$59.75	\$57.10	98

* Fits MIL-C-17 and equivalent cable versions only

Connectors





See Our Website For Current Pricing & Real-Time Stock Availability!

4.3-10 Connectors

Connection Method	Product Image	Attachment Cable/Contact	Coax Type / Termination Type	Model No.	PRICE				ROW
					1-24	25-49	50-99	100 +	
Male									
Cable Connectors		Solder/Solder	PE-1/4SFHC	PE45297	\$40.90	\$38.86	\$36.81	\$35.17	99
			PE-1/4SFHC	PE45298	\$17.30	\$16.44	\$15.57	\$14.88	1
			PE-1/2SFHC	PE45299	\$17.54	\$16.66	\$15.79	\$15.08	2
			PE-1/2SFHC	PE45300	\$29.63	\$28.15	\$26.67	\$25.48	3
			RG402, PE-SR402AL, PE-SR402FL, PE-SR402FLJ	PE45301	\$30.29	\$28.78	\$27.26	\$26.05	4
			SPP-250-LLPL	PE45418	\$27.80	\$26.41	\$25.02	\$23.91	5
			SPO-375, SPF-375, SPP-375-LLPL	TC-SPO375-4310M-LP	\$18.40	\$18.40	\$18.40	\$18.40	6
	SPP-250-LLPL	TC-SPP250-4310MS-LP	\$17.25	\$17.25	\$17.25	\$17.25	7		
		Crimp/Non-Solder Contact	LMR-240	EZ-240-4310M-X	\$19.54	\$19.54	\$19.54	\$19.54	8
Male Right Angle									
Cable Connectors		Solder/Solder	PE-1/2SFHC	PE45302	\$47.46	\$45.09	\$42.71	\$40.82	9
			RG402, PE-SR402AL, PE-SR402FL, PE-SR402FLJ	PE45303	\$52.91	\$50.26	\$47.62	\$45.50	10
			SPP-250-LLPL	PE45419	\$38.22	\$36.31	\$34.40	\$32.87	11
			SPP-250-LLPL, SPO-250, SPF-250	TC-250-4310M-RA-LP	\$18.40	\$18.40	\$18.40	\$18.40	12
Female									
Cable Connectors		Solder/Solder	SPP-250-LLPL	PE45417	\$31.26	\$29.70	\$28.13	\$26.88	13
			SPP-250-LLPL, SPO-250, SPF-250	TC-SPP250-4310F-LP	\$17.25	\$17.25	\$17.25	\$17.25	14
Female, 4 Hole Flange Mount									
Cable Connectors		Solder/Solder	RG402, PE-SR402AL, PE-SR402FL, PE-SR402FLJ	PE45304	\$25.13	\$23.87	\$22.62	\$21.61	15
Terminal		Solder	Solder Cup	PE45306	\$19.24	\$18.28	\$17.32	\$16.55	16

Connectors















7/16 DIN Connectors

Connection Method	Product Image	Attachment Cable/Contact	Coax Type / Termination Type	Model No.	PRICE		ROW	
					1 Pc.	See Web for Volume Pricing		
Male								
Cable Connectors		Crimp/Solder	PE-C195, PE-P195, RG58, RG141, RG303, LMR-195, .195 inch	PE44536	\$39.63	See Web for Volume Pricing	17	
			RG55, RG141, RG142, RG223, RG400	PE4568	\$85.15		18	
			RG58	PE4569	\$99.09		19	
			RG213, RG8	PE4570	\$111.83		20	
			RG214, RG9, RG225, RG393	PE4571	\$55.39		21	
		Clamp/Solder	RG14, RG217	PE44276	\$149.99		22	
			RG17, RG218, RG219	PE44277	\$164.54		23	
			PE-SR401AL, PE-SR401FL, RG401	PE44278	\$44.19		24	
			7/8 inch Helical	PE44558	\$88.50		25	
			7/8 inch Annular	PE44568	\$56.37		26	
			7/8 inch Annular	PE44993	\$46.12		27	
		Solder/Solder	RG58, RG55, RG141, RG142, RG223, RG400	PE45037	\$112.87		28	
			RG393, RG214, RG225, RG215, RG8	PE4567	\$41.53		29	
			Solder/Solder	SPP-250-LLPL	PE45424		\$31.26	30
			Clamp/Non-Solder Contact	LMR-SW396	EZ-SW396-716MC		\$24.28	31
				LMR-SW540	EZ-SW540-716MC		\$22.20	32
				1/4 inch Superflexible, PE-1/4SFHC	PE44728		\$65.85	33
1/2 inch Helical, 1/2 inch Superflexible, PE-1/2 Helical, PE-1/2SFHC				PE44732	\$45.09	34		

See Our Website For Current Pricing & Real-Time Stock Availability!

* Fits MIL-C-17 and equivalent cable versions only

7/16 DIN Connectors





Connection Method	Product Image	Attachment Cable/Contact	Coax Type / Termination Type	Model No.	PRICE			ROW
					1 Pc.	See Web for Volume Pricing		
Male								
Cable Connectors		Clamp/Non-Solder Contact	1/2 inch Flexible, PE-1/2FAC	PE44738	\$42.10			35
		Crimp/Non-Solder Contact	LMR-400, PE-C400, PE-B400, PE-B405	EZ-400-716M-X	\$20.75	See Web for Volume Pricing		36
			LMR-600, PE-C600	EZ-600-716M-X	\$25.25			37
			PE-C400, PE-B400, PE-B405, LMR-400, LMR-400-DB, LMR-400-UF, .400 inch	PE44538	\$63.83			38
			PE-C240, RG8X, .240 inch, LMR-240, LMR-240-DB, LMR-240-UF, B7808A	PE44994	\$43.47			39
LMR-600, PE-C600	PE45001	\$60.91	40					
Male Right Angle								
Cable Connectors		Crimp/Solder	PE-C240, RG8X, .240 inch, LMR-240, LMR-240-DB, LMR-240-UF, B7808A	PE44541	\$82.95	See Web for Volume Pricing		41
			PE-C400, PE-B400, PE-B405, LMR-400, LMR-400-DB, LMR-400-UF	PE44542	\$67.73			42
			PE-C600, .600 inch	PE44543	\$80.37			43
			LMR-195, LMR-195-FR, PE-C195, PE-P195	PE45046	\$42.11			44
	RG213, RG214, RG8, RG9, RG225, RG393, RG215	PE44280	\$130.25	45				
		Clamp/Solder	RG14, RG217	PE44282	\$217.76			46
				Solder/Solder	SPP-250-LLPL			PE45425
	SPP-250-LLPL	TC-SPP250-716M-RA-LP			\$18.40			48
		Clamp/Non-Solder Contact	1/2 inch Annular, 1/2 inch Flexible, PE-1/2FAC	PE44569	\$48.94			49
			1/2 inch Helical	PE44979	\$34.37			50
		Crimp/Non-Solder Contact	LMR-400, PE-C400, PE-B400, PE-B405	EZ-400-716M-RA-X	\$23.00			51
Female								
Cable Connectors		Crimp/Solder	RG213, RG8	PE44284	\$124.34	See Web for Volume Pricing		52
			RG55, RG142, RG223, RG400	PE44286	\$141.32			53
			RG58	PE44287	\$100.97			54
			PE-C195, PE-P195, RG58, RG141, RG303, LMR-195, .195 inch	PE44544	\$36.74			55
			PE-C400, PE-B400, PE-B405, LMR-400, LMR-400-DB, LMR-400-UF	PE44546	\$72.30			56
			RG214, RG9, RG225, RG393	PE4575	\$152.75			57
		Clamp/Solder	RG213, RG55, RG141, RG142, RG223, RG400, RG303, PE-C195, PE-P195, LMR-195	PE44283	\$151.23			58
			RG58, RG55, RG141, RG142, RG223, RG400	PE44285	\$136.02			59
			RG14, RG217	PE44288	\$151.09			60
			PE-SR401AL, PE-SR401FL, RG401	PE44289	\$114.10			61
		Clamp/Solder	PE-SR402AL, PE-SR402FL, RG402	PE44290	\$109.82			62
			1/2 inch Helical	PE44560	\$40.38			63
		Clamp/Solder	7/8 inch Helical	PE44561	\$79.60			64
			SPP-250-LLPL	PE45423	\$31.26			65
		Solder/Solder	SPP-250-LLPL	TC-SPP250-716F-LP	\$13.80			66
			SPP-375-LLPL, SPO-375, SPF-375	TC-SPP375-716F-LP	\$13.80			67
	Clamp/Non-Solder Contact	1/2 inch Superflexible, PE-1/2SFHC	PE44734	\$45.09	68			
		1/2 inch Flexible, PE-1/2FAC	PE44740	\$35.08	69			
	Crimp/Non-Solder Contact	PE-C240, LMR-240, RG8X	PE44545	\$60.13	70			
Female, Bulkhead Mount								
Cable Connectors		Crimp/Solder	.195 inch, RG58, RG141, RG303, LMR-195, LMR-195-FR, PE-C195, PE-P195 with 1.161 inch DD Hole	PE44548	\$101.03			71
			PE-C240, RG8X, .240 inch, LMR-240, LMR-240-DB, LMR-240-UF, B7808A	PE44549	\$74.96			72

* Fits MIL-C-17 and equivalent cable versions only





Connectors

See Our Website For Current Pricing & Real-Time Stock Availability!

7/16 DIN Connectors



Connection Method	Product Image	Attachment Cable/Contact	Coax Type / Termination Type	Model No.	PRICE				ROW					
					1 Pc.	See Web for Volume Pricing								
Female, Bulkhead Mount														
Cable Connectors		Crimp/Solder	.400 inch, LMR-400, LMR-400-DB, LMR-400-UF, PE-B405, PE-C400, PE-B400 with 1.161 inch DD Hole	PE44550	\$86.00	See Web for Volume Pricing				73				
			PE-C600, LMR-600, LMR-600-DB, .600 inch with 1.161 inch DD Hole	PE44551	\$104.69					74				
			RG55, RG142, RG223, RG400 with 1.161 inch DD Hole	PE44656	\$75.41					75				
Terminal		Solder	Solder Cup	PE4572	\$171.15					76				
Female, 4 Hole Flange Mount														
Cable Connectors		Clamp/Solder	RG214, RG213, RG393, RG8, RG225, RG215, RG9 with .975 inch Hole Spacing	PE44291	\$178.11	See Web for Volume Pricing				77				
			RG14, RG217 with .975 inch Hole Spacing	PE44292	\$187.11					78				
Terminal		Solder	Stub	PE45000	\$54.42									79
			Solder Cup with .975 inch Hole Spacing	PE4573	\$99.10									80
		Field Replaceable	Slotted Contact	PE44717	\$139.44									81
			Threaded Pin	Pin with .975 inch Hole Spacing	PE4574									\$90.90
Pin with .975 inch Hole Spacing	PE4574A	\$37.11		83										

10-32 Connectors











Connection Method	Product Image	Attachment Cable/Contact	Coax Type / Termination Type	Model No.	PRICE				ROW
					1-24	25-49	50-99	100 +	
Male									
Cable Connectors		Crimp/Solder	RG174, RG316, RG188, LMR-100, PE-B100, PE-C100, .100 inch	PE44351	\$22.82	\$21.68	\$20.54	\$19.63	84
			RG178, RG196	PE44352	\$37.37	\$35.50	\$33.63	\$32.14	85
			RG188-DS, RG316-DS	PE45170	\$23.49	\$22.32	\$21.14	\$20.20	86
		Clamp/Solder	RG174, RG316, RG188, PE-B100, PE-C100, .100 inch, LMR-100	PE44353	\$34.47	\$32.75	\$31.02	\$29.64	87
RG178, RG196	PE44354		\$40.61	\$38.99	\$37.77	\$36.96	88		
Male Right Angle									
Cable Connectors		Crimp/Solder	RG174, RG316, RG188, PE-B100, PE-C100, .100 inch, LMR-100	PE44355	\$24.86	\$23.62	\$22.37	\$21.38	89
			RG178, RG196	PE44356	\$41.03	\$38.98	\$36.93	\$35.29	90
			RG316-DS, RG188-DS	PE45032	\$25.12	\$23.86	\$22.61	\$21.60	91
Female									
Cable Connectors		Crimp/Solder	RG174, RG316, RG188, PE-B100, PE-C100, .100 inch, LMR-100	PE44361	\$33.21	\$31.55	\$29.89	\$28.56	92
			RG178, RG196	PE44362	\$31.58	\$30.32	\$29.37	\$28.74	93
			RG188-DS, RG316-DS	PE45171	\$24.96	\$23.71	\$22.46	\$21.47	94
		Clamp/Solder	RG174, RG316, RG188, PE-B100, PE-C100, .100 inch, LMR-100	PE44363	\$41.27	\$39.21	\$37.14	\$35.49	95
RG178, RG196	PE44364		\$34.78	\$33.04	\$31.30	\$29.91	96		
PCB Mount		Solder	Thru Hole with .200 inch x .067 inch Hole Spacing	PE44359	\$25.00	\$23.75	\$22.50	\$21.50	97
Female, Bulkhead Mount									
Cable Connectors		Crimp/Solder	RG174, RG316, RG188 with .295 inch D Hole	PE44365	\$33.86	\$32.17	\$30.47	\$29.12	98
			RG178, RG196 with .295 inch D Hole	PE44366	\$32.71	\$31.07	\$29.44	\$28.13	99
		Clamp/Solder	.100 inch, RG316, RG174, RG188, LMR-100, LMR-100A, LMR-100A-FR, PE-C100, PE-B100 with .295 inch D Hole	PE44367	\$31.35	\$29.78	\$28.22	\$26.96	1
			RG178, RG196 with .295 inch D Hole	PE44368	\$36.21	\$34.40	\$32.59	\$31.14	2

* Fits MIL-C-17 and equivalent cable versions only

10-32 Connectors

Connection Method	Product Image	Attachment Cable/Contact	Coax Type / Termination Type	Model No.	PRICE				ROW
					1-24	25-49	50-99	100 +	
Terminal		Solder	Solder Cup with .177 inch D Hole	PE44357	\$26.56	\$25.23	\$23.90	\$22.84	3
			Solder Cup with .295 inch D Hole	PE44358	\$34.78	\$33.04	\$31.30	\$29.91	4
Female Right Angle									
PCB Mount		Solder	Thru Hole with .200 inch x .067 inch Hole Spacing	PE44360	\$30.57	\$29.04	\$27.51	\$26.29	5

BMA Connectors









Connection Method	Product Image	Attachment Cable/Contact	Coax Type / Termination Type	Model No.	PRICE				ROW
					1 Pc.	See Web for Volume Pricing			
Plug									
PCB Mount		Solder	Thru Hole	PE45335	\$58.77				7
			Thru Hole	PE45336	\$32.82				8
Plug, Bulkhead Mount									
Cable Connectors		Crimp/Solder	RG178, RG196	PE45315	\$76.57	See Web for Volume Pricing			9
			RG316, RG188, RG174, PE-C100, LMR-100A	PE45316	\$46.76				10
			RG188-DS, RG316-DS	PE45317	\$34.40				11
			RG142, RG223, RG400, RG55	PE45318	\$33.45				12
		Solder/Non-Solder Contact	RG405, PE-SR405AL, PE-SR405FL, PE-SR405FLJ, PE-SR405TN	PE45310	\$35.86				13
			RG405, PE-SR405AL, PE-SR405FL, PE-SR405FLJ, PE-SR405TN	PE45311	\$23.83				14
			RG402, PE-SR402AL, PE-SR402FL, PE-SR402FLJ, PE-SR402TN	PE45313	\$56.70				15
			RG402, PE-SR402AL, PE-SR402FL, PE-SR402FLJ, PE-SR402TN	PE45314	\$22.99				16
Plug, 2 Hole Flange Mount									
Terminal		Solder	Stub with .481 inch Hole Spacing	PE45341	\$30.32	See Web for Volume Pricing			17
			Stub with .481 inch Hole Spacing	PE45342	\$34.84				18
			Stub with .481 inch Hole Spacing	PE45343	\$11.17				19
			Stub with .481 inch Hole Spacing	PE45344	\$15.63				20
			Stub with .481 inch Hole Spacing	PE45347	\$64.46				21
Field Replaceable		Field Replaceable	.012 inch Pin with .481 inch Hole Spacing	PE45345	\$226.35	22			
			.020 inch Pin with .481 inch Hole Spacing	PE45346	\$216.16	23			
			.036 inch Pin with .481 inch Hole Spacing	PE45348	\$70.97	24			
Plug, 4 Hole Flange Mount									
Terminal		Solder	Stub with .340 inch Hole Spacing	PE45339	\$35.37				25
Plug, Thread-In									
Terminal		None	Pin	PE45350	\$104.84	See Web for Volume Pricing			26
			Pin	PE45351	\$62.99				27
			Pin	PE45352	\$119.74				28
			Pin	PE45353	\$133.78				29
Plug Right Angle									
PCB Mount		Solder	Surface Mount	PE45333	\$133.97				30
			Thru Hole	PE45355	\$37.68				31
Jack									
Cable Connectors		Crimp/Solder	RG316, RG188, RG174, PE-C100, LMR-100A	PE45319	\$76.69	See Web for Volume Pricing			32
			RG142, RG223, RG400, RG55	PE45320	\$101.91				33
		Solder/Solder	RG405, PE-SR405AL, PE-SR405FL, PE-SR405FLJ	PE45324	\$68.06				34
			RG405, PE-SR405AL, PE-SR405FL, PE-SR405FLJ	PE45325	\$96.82				35

* Fits MIL-C-17 and equivalent cable versions only



Connectors

See Our Website For Current Pricing & Real-Time Stock Availability!

BMA Connectors

Connection Method	Product Image	Attachment Cable/Contact	Coax Type / Termination Type	Model No.	PRICE				ROW
					1 Pc.	See Web for Volume Pricing			
Jack									
Cable Connectors		Solder/Non-Solder Contact	RG402, PE-SR402AL, PE-SR402FL, PE-SR402FLJ, PE-SR402TN	PE45328	\$76.04				36
PCB Mount		Solder	Thru Hole	PE45337	\$50.86	See Web for Volume Pricing			37
			Surface Mount	PE45338	\$56.90				38
Terminal			Stub	PE45349	\$185.40				
Jack, Bulkhead Mount									
Cable Connectors		Solder/Solder	RG405, PE-SR405AL, PE-SR405FL, PE-SR405FLJ	PE45323	\$43.74				40
Jack, 2 Hole Flange Mount									
Cable Connectors		Solder/Solder	RG316, RG188, RG174, LMR-100A, PE-C100-LSZH	PE45321	\$42.35	See Web for Volume Pricing			41
			RG402, PE-SR402AL, PE-SR402FL, PE-SR402FLJ, PE-SR402TN	PE45326	\$56.64				42
	RG402, PE-SR402AL, PE-SR402FL, PE-SR402FLJ, PE-SR402TN	PE45327	\$36.47	43					
	Solder/Non-Solder Contact	RG405, PE-SR405AL, PE-SR405FL, PE-SR405FLJ	PE45322	\$49.49	44				
Terminal		Solder	Stub	PE45340	\$58.87				45
Jack, 4 Hole Flange Mount									
Terminal		Solder	Stub with .340 inch Hole Spacing	PE45334	\$54.24				46
Jack, Thread-In									
Terminal		None	Pin	PE45354	\$60.77				47
Jack Right Angle, 2 Hole Flange Mount									
Cable Connectors		Crimp/Solder	RG142, RG223, RG400, RG55	PE45332	\$55.56	See Web for Volume Pricing			48
			RG402, PE-SR402AL, PE-SR402FL, PE-SR402FLJ, PE-SR402TN	PE45329	\$66.94				49
	Solder/Solder	RG405, PE-SR405AL, PE-SR405FL, PE-SR405FLJ	PE45330	\$74.29	50				
		RG405, PE-SR405AL, PE-SR405FL, PE-SR405FLJ	PE45331	\$61.38	51				

BNC Connectors

Connection Method	Product Image	Attachment Cable/Contact	Coax Type / Termination Type	Model No.	PRICE				ROW
					1-24	25-49	50-99	100 +	
Male									
Cable Connectors		Crimp/Crimp	RG58, RG303, RG141, PE-C195, PE-P195, LMR-195, .195 inch	PE4016	\$7.04	\$6.69	\$6.34	\$6.05	52
			RG59*, RG62*, RG71	PE4018	\$9.58	\$9.10	\$8.62	\$8.24	53
			.100 inch, RG316, RG174, RG188, LMR-100, LMR-100, LMR-100-FR, PE-C100, PE-B100	PE45045	\$7.30	\$6.94	\$6.57	\$6.28	54
			RG316-DS, RG188-DS	PE45114	\$8.07	\$7.67	\$7.26	\$6.94	55
	RG55, RG141, RG142, RG223, RG400	PE4044	\$7.58	\$7.20	\$6.82	\$6.52	56		
		Crimp/Solder	PE-B305	PE4210	\$13.04	\$12.39	\$11.74	\$11.21	57

* Fits MIL-C-17 and equivalent cable versions only

BNC Connectors

Connection Method	Product Image	Attachment Cable/Contact	Coax Type / Termination Type	Model No.	PRICE				ROW	
					1-24	25-49	50-99	100 +		
Male										
Cable Connectors		Crimp/Solder	PE-B150, RG180, RG195	PE4247	\$13.58	\$12.90	\$12.22	\$11.68	58	
			RG214, RG9, RG225, RG393	PE4351	\$22.73	\$21.59	\$20.46	\$19.55	59	
			RG213, RG215, RG8	PE4378	\$25.30	\$24.04	\$22.77	\$21.76	60	
			RG58 Plenum, RG122, RG58-P	PE4381	\$17.52	\$16.64	\$15.77	\$15.07	61	
			RG59* Plenum, RG59*-P, RG302	PE4382	\$18.23	\$17.32	\$16.41	\$15.68	62	
			PE-C400, LMR-400	PE44294	\$30.95	\$29.40	\$27.86	\$26.62	63	
			PE-C240, RG8X, .240 inch, LMR-240, LMR-240-DB, LMR-240-UF, B7808A	PE44640	\$15.52	\$14.74	\$13.97	\$13.35	64	
			RG178, RG196	PE4643	\$23.45	\$22.28	\$21.11	\$20.17	65	
			LMR-200, PE-C200	TC-200-BM-X	\$13.75	\$13.75	\$13.75	\$13.75	66	
			LMR-240, PE-C240	TC-240-BM-X	\$11.50	\$11.50	\$11.50	\$11.50	67	
	LMR-400, PE-C400	TC-400-BM-X	\$13.87	\$13.87	\$13.87	\$13.87	68			
		Clamp/Solder	RG58, RG55, RG141, RG142, RG223, RG400, RG303, PE-C195, PE-P195, LMR-195	PE4023	\$8.59	\$8.25	\$7.99	\$7.82	69	
			RG59*, RG62*, RG71	PE4024	\$10.30	\$9.79	\$9.27	\$8.86	70	
			RG174, RG316, RG188, .100 inch, PE-B100, PE-C100, LMR-100	PE4084	\$13.42	\$12.75	\$12.08	\$11.54	71	
			RG8, RG215, RG225, RG214, RG393, RG213	PE4109	\$19.10	\$18.15	\$17.19	\$16.43	72	
			PE-SR402AL, PE-SR402FL, RG402	PE4206	\$20.50	\$19.48	\$18.45	\$17.63	73	
			PE-SR405AL, PE-SR405FL, RG405	PE4207	\$23.14	\$21.98	\$20.83	\$19.90	74	
			RG6	PE4377	\$17.05	\$16.20	\$15.35	\$14.66	75	
			RG8X, PE-C240, .240 inch, B7808A, LMR-240	PE4379	\$18.53	\$17.60	\$16.68	\$15.94	76	
			PE-SR401AL, PE-SR401FL, RG401	PE4380	\$22.81	\$21.67	\$20.53	\$19.62	77	
			PE-B150, RG180, RG195	PE4383	\$38.52	\$36.59	\$34.67	\$33.13	78	
		Solder/Solder	RG178, RG196	PE4384	\$16.61	\$15.78	\$14.95	\$14.28	79	
			PE-B400, PE-B405, PE-C400, LMR-400, .400 inch	PE4386	\$28.26	\$26.85	\$25.43	\$24.30	80	
			PE-C200	PE44040	\$15.91	\$15.11	\$14.32	\$13.68	81	
			PE-C300	PE44042	\$14.46	\$13.74	\$13.01	\$12.44	82	
			LMR-240, PE-C240	TC-240-BMC	\$18.50	\$18.50	\$18.50	\$18.50	83	
			PE-SR402AL, PE-SR402FL, PE-SR402FLJ, PE-SR402TN, RG402	PE4650	\$10.97	\$10.42	\$9.87	\$9.43	84	
			PE-SR405AL, PE-SR405FL, RG405	PE4651	\$26.04	\$24.74	\$23.44	\$22.39	85	
			PE-SR401AL, PE-SR401FL, RG401	PE4908	\$48.99	\$46.54	\$44.09	\$42.13	86	
			PE-047SR, PE-SR047AL, PE-SR047FL	PE4974	\$39.67	\$37.69	\$35.70	\$34.12	87	
				Crimp/Non-Solder Contact	LMR-400, PE-C400, LMR-400-DB	EZ-400-BM-X	\$15.50	\$15.50	\$15.50	\$15.50
	Male, Bulkhead Mount									
	Terminal		Solder	Solder Cup with .350 inch D Hole	PE4211	\$16.05	\$15.25	\$14.45	\$13.80	89
	Male, 4 Hole Flange Mount									
	Terminal		Solder	Solder Cup with .531 inch Hole Spacing	PE4082	\$17.92	\$17.02	\$16.13	\$15.41	90
	Male Right Angle									
	Cable Connectors		Crimp/Crimp	RG58, RG303, RG141, PE-C195, PE-P195, LMR-195, .195 inch	PE4298	\$24.67	\$23.44	\$22.20	\$21.22	91
				RG59*, RG62*, RG71	PE4195	\$25.84	\$24.55	\$23.26	\$22.22	92
		Crimp/Solder	RG55, RG141, RG142, RG223, RG400	PE4345	\$10.95	\$10.40	\$9.86	\$9.42	93	
			RG174, RG316, RG188, .100 inch, PE-B100, PE-C100, LMR-100	PE4393	\$25.90	\$24.61	\$23.31	\$22.27	94	
			RG188-DS, RG316-DS	PE4396	\$29.40	\$27.93	\$26.46	\$25.28	95	
			PE-C240, RG8X, .240 inch, LMR-240, LMR-240-DB, LMR-240-UF, B7808A	PE44641	\$26.25	\$24.94	\$23.63	\$22.58	96	
			PE-C200, LMR-200	PE44843	\$20.59	\$19.56	\$18.53	\$17.71	97	
		Clamp/Solder	RG58, RG55, RG141, RG142, RG223, RG400, RG303, PE-C195, PE-P195, LMR-195	PE4053	\$18.85	\$17.91	\$16.97	\$16.21	98	
			RG174, RG316, RG188, .100 inch, PE-B100, PE-C100, LMR-100	PE4307	\$51.52	\$48.94	\$46.37	\$44.31	99	
			RG59*, RG62*	PE4320	\$24.17	\$22.96	\$21.75	\$20.79	1	
			RG213, RG214, RG8, RG9, RG11*, RG225, RG393, RG144*, RG216*, RG215	PE4387	\$37.28	\$35.42	\$33.55	\$32.06	2	

* Fits MIL-C-17 and equivalent cable versions only

Connectors

See Our Website For Current Pricing & Real-Time Stock Availability!

BNC Connectors







Connection Method	Product Image	Attachment Cable/Contact	Coax Type / Termination Type	Model No.	PRICE				ROW	
					1-24	25-49	50-99	100 +		
Male Right Angle										
Cable Connectors		Clamp/Solder	RG178, RG196	PE4388	\$23.52	\$22.34	\$21.17	\$20.23	3	
		Solder/Solder	PE-SR402AL, PE-SR402FL, PE-SR402FLJ, PE-SR402TN, RG402	PE4092	\$37.63	\$35.75	\$33.87	\$32.36	4	
		Solder/Solder	PE-SR405AL, PE-SR405FL, RG405	PE45239	\$39.20	\$37.24	\$35.28	\$33.71	5	
Female										
Cable Connectors		Crimp/Solder	PE-C195, PE-P195, RG58, RG141, RG303, LMR-195, .195 inch	PE4070	\$10.37	\$9.85	\$9.33	\$8.92	6	
			RG174, RG316, RG188, LMR-100, PE-B100, PE-C100, .100 inch	PE4079	\$13.88	\$13.19	\$12.49	\$11.94	7	
			RG59*, RG62*, RG71	PE4308	\$8.81	\$8.37	\$7.93	\$7.58	8	
			RG55, RG141, RG142, RG223, RG400	PE4397	\$10.76	\$10.22	\$9.68	\$9.25	9	
			PE-C240, RG8X, .240 inch, LMR-240, LMR-240-DB, LMR-240-UF, B7808A	PE44642	\$8.43	\$8.01	\$7.59	\$7.25	10	
			RG59*, RG62*, RG71	PE4057	\$9.98	\$9.48	\$8.98	\$8.58	11	
			RG58, RG55, RG141, RG142, RG223, RG400, RG303, PE-C195, PE-P195, LMR-195	PE4058	\$10.49	\$9.97	\$9.44	\$9.02	12	
			PE-SR402AL, PE-SR402FL, RG402	PE4204	\$28.30	\$26.89	\$25.47	\$24.34	13	
			PE-SR405AL, PE-SR405FL, RG405	PE4205	\$29.40	\$27.93	\$26.46	\$25.28	14	
			RG213, RG214, RG8, RG9, RG11*, RG225, RG393, RG144*, RG216*, RG215	PE4212	\$45.63	\$43.35	\$41.07	\$39.24	15	
	RG174, RG316, RG188	PE4321	\$13.89	\$13.20	\$12.50	\$11.95	16			
	RG178, RG196	PE4389	\$18.82	\$17.88	\$16.94	\$16.19	17			
	PE-SR401AL, PE-SR401FL, RG401	PE44674	\$30.92	\$29.37	\$27.83	\$26.59	18			
		Solder/Solder	PE-SR401FL, PE-SR401AL, RG401	PE45150	\$30.59	\$29.06	\$27.53	\$26.31	19	
	PCB Mount		Solder	End Launch	PE44616	\$13.38	\$12.71	\$12.04	\$11.51	20
	Female, Bulkhead Mount									
	Cable Connectors		Crimp/Solder	RG58, PE-C195, PE-P195, LMR-195	PE45064	\$14.75	\$14.01	\$13.28	\$12.69	21
				RG174, RG316, RG188, LMR-100, PE-B100, PE-C100, .100 inch with .480 inch D Hole	PE4106	\$15.54	\$14.76	\$13.99	\$13.36	22
RG58 with .480 inch D Hole				PE4208	\$13.62	\$12.94	\$12.26	\$11.71	23	
RG55, RG142, RG223, RG400, RG141 with .480 inch D Hole				PE4209	\$20.39	\$19.37	\$18.35	\$17.54	24	
RG59*, RG62*, RG71 with .480 inch D Hole				PE4309	\$19.42	\$18.45	\$17.48	\$16.70	25	
RG188-DS, RG316-DS with .480 inch D Hole				PE4392	\$19.17	\$18.21	\$17.25	\$16.49	26	
RG178, RG196 with .480 inch D Hole				PE44658	\$21.48	\$20.41	\$19.33	\$18.47	27	
RG316, RG174, LMR-100				PE45131	\$32.12	\$30.51	\$28.91	\$27.62	28	
		Clamp/Solder	RG58, RG142, RG223, RG400, RG141, RG303, RG55, LMR-400, PE-C195, PE-P195 with .480 inch D Hole	PE4078	\$18.01	\$17.11	\$16.21	\$15.49	29	
			RG59*, RG62* with .480 inch D Hole	PE4310	\$28.69	\$27.26	\$25.82	\$24.67	30	
			RG174, RG316, RG188 with .480 inch D Hole	PE4319	\$17.30	\$16.44	\$15.57	\$14.88	31	
			RG178, RG196 with .480 inch D Hole	PE4391	\$20.83	\$19.79	\$18.75	\$17.91	32	
			RG316-DS, RG188-DS	PE44886	\$30.56	\$29.03	\$27.50	\$26.28	33	
			RG214, RG213, RG393, RG8, RG225, RG11*, RG216*, RG144*, RG215, RG9 with .480 inch D Hole	PE4632	\$49.76	\$47.27	\$44.78	\$42.79	34	
			PE-SR402AL, PE-SR402FL, RG402	PE4915	\$34.31	\$32.59	\$30.88	\$29.51	35	
			PE-SR405AL, PE-SR405FL, RG405	PE4916	\$31.76	\$30.17	\$28.58	\$27.31	36	
			Terminal		Solder	Solder Cup with .410 inch D Hole	PE4014	\$7.53	\$7.15	\$6.78
Solder Cup with .350 inch D Hole	PE4015	\$8.28				\$7.87	\$7.45	\$7.12	38	
Turret with .480 inch D Hole	PE4049	\$18.53				\$17.60	\$16.68	\$15.94	39	
Spade with .350 inch D Hole	PE4077	\$18.30				\$17.39	\$16.47	\$15.74	40	
Solder Cup with .350 inch D Hole	PE4091	\$9.22				\$8.76	\$8.30	\$7.93	41	
Solder Cup with .480 inch D Hole	PE4318	\$17.79				\$16.90	\$16.01	\$15.30	42	
PCB Mount		Solder	End Launch with .500 inch Diameter	PE44618	\$19.98	\$18.98	\$17.98	\$17.18	43	

Connectors





See Our Website For Current Pricing & Real-Time Stock Availability!

* Fits MIL-C-17 and equivalent cable versions only

BNC Connectors

Connection Method	Product Image	Attachment Cable/Contact	Coax Type / Termination Type	Model No.	PRICE				ROW
					1-24	25-49	50-99	100 +	
Female, Bulkhead Mount									
Terminal		Solder	Eyelet	PE44890	\$27.41	\$26.04	\$24.67	\$23.57	44
			Eyelet	PE44891	\$93.45	\$88.78	\$84.11	\$80.37	45
Female, 4 Hole Flange Mount									
Cable Connectors		Clamp/Solder	RG58, RG142, RG223, RG400, RG141, RG303, RG55, LMR-400, PE-C195, PE-P195 with .500 inch Threaded Hole Spacing	PE4056	\$17.95	\$17.05	\$16.16	\$15.44	46
			RG316-DS, RG188-DS	PE44887	\$38.53	\$36.60	\$34.68	\$33.14	47
		Solder/Solder	PE-047SR, PE-SR047FL, PE-SR047AL	PE44888	\$40.33	\$38.31	\$36.30	\$34.68	48
Terminal		Solder	Solder Cup with .500 inch Threaded Hole Spacing	PE4010	\$9.51	\$9.03	\$8.56	\$8.18	49
			Turret with .531 inch Hole Spacing	PE4011	\$20.55	\$19.52	\$18.50	\$17.67	50
			Solder Cup with .500 inch Hole Spacing	PE4394	\$13.80	\$13.11	\$12.42	\$11.87	51
			Solder Cup with .718 inch Hole Spacing	PE4395	\$24.22	\$23.01	\$21.80	\$20.83	52
	Field Replaceable	Slotted Contact	PE44720	\$52.95	\$50.30	\$47.66	\$45.54	53	
Female Right Angle, Bulkhead Mount									
Terminal		Solder	Solder Cup with .361 inch D Hole	PE4055	\$27.49	\$26.12	\$24.74	\$23.64	54
Female Right Angle, 4 Hole Flange Mount									
Terminal		Solder	Solder Cup with .531 inch Hole Spacing	PE4317	\$32.48	\$30.86	\$29.23	\$27.93	55

Reverse Polarity BNC Connectors

Connection Method	Product Image	Attachment Cable/Contact	Coax Type / Termination Type	Model No.	PRICE				ROW
					1-24	25-49	50-99	100 +	
Male									
Cable Connectors		Crimp/Solder	RG213, RG8	PE4712	\$29.35	\$27.88	\$26.42	\$25.24	56
			RG214, RG9, RG225, RG393	PE4713	\$31.35	\$29.78	\$28.22	\$26.96	57
			RG55, RG141, RG142, RG223, RG400	PE4715	\$14.89	\$14.15	\$13.40	\$12.81	58
			RG58, RG303, RG141, PE-C195, PE-P195, LMR-195, .195 inch	PE4716	\$17.48	\$16.61	\$15.73	\$15.03	59
			RG59*, RG62*	PE4718	\$16.57	\$15.74	\$14.91	\$14.25	60
		Clamp/Solder	RG174, RG316, RG188, LMR-100, PE-B100, PE-C100, .100 inch	PE4720	\$24.37	\$23.15	\$21.93	\$20.96	61
	RG213, RG214, RG8, RG9, RG225, RG393, RG215		PE4711	\$36.57	\$34.74	\$32.91	\$31.45	62	
	RG58, RG55, RG141, RG142, RG223, RG400, RG303, PE-C195, PE-P195, LMR-195		PE4714	\$36.24	\$34.43	\$32.62	\$31.17	63	
	RG59*, RG62*		PE4717	\$14.99	\$14.24	\$13.49	\$12.89	64	
	RG174, RG316, RG188, LMR-100, PE-B100, PE-C100, .100 inch		PE4719	\$36.57	\$34.74	\$32.91	\$31.45	65	
	Clamp/Solder	RG178, RG196	PE4721	\$26.79	\$25.45	\$24.11	\$23.04	66	
PE-SR402AL, PE-SR402FL, RG402		PE4722	\$22.98	\$21.83	\$20.68	\$19.76	67		
PE-B400, PE-B405		PE4726	\$28.76	\$27.32	\$25.88	\$24.73	68		
Male, 4 Hole Flange Mount									
Terminal		Solder	Solder Cup with .531 inch Hole Spacing	PE4762	\$24.13	\$22.92	\$21.72	\$20.75	69
Male Right Angle									
Cable Connectors		Crimp/Solder	RG55, RG141, RG142, RG223, RG400	PE4729	\$24.82	\$23.58	\$22.34	\$21.35	70
			RG58, RG303, RG141, PE-C195, PE-P195, LMR-195, .195 inch	PE4730	\$29.91	\$28.41	\$26.92	\$25.72	71
			RG174, RG316, RG188	PE4733	\$24.37	\$23.15	\$21.93	\$20.96	72

* Fits MIL-C-17 and equivalent cable versions only

Connectors

See Our Website For Current Pricing & Real-Time Stock Availability!

Reverse Polarity BNC Connectors

Connection Method	Product Image	Attachment Cable/Contact	Coax Type / Termination Type	Model No.	PRICE				ROW			
					1-24	25-49	50-99	100 +				
Male Right Angle												
Cable Connectors		Clamp/Solder	RG213, RG214, RG8, RG9, RG225, RG393, RG215	PE4727	\$45.31	\$43.04	\$40.78	\$38.97	73			
			RG58, RG55, RG141, RG142, RG223, RG400, RG303, PE-C195, PE-P195, LMR-195	PE4728	\$25.17	\$23.91	\$22.65	\$21.65	74			
			RG59*, RG62*	PE4731	\$30.17	\$28.66	\$27.15	\$25.95	75			
			RG174, RG316, RG188	PE4732	\$25.78	\$24.49	\$23.20	\$22.17	76			
Female												
Cable Connectors		Crimp/Solder	RG188-DS, RG316-DS	PE45182	\$22.20	\$21.09	\$19.98	\$19.09	77			
			RG55, RG141, RG142, RG223, RG400	PE4737	\$22.29	\$21.18	\$20.06	\$19.17	78			
			RG58	PE4738	\$26.34	\$25.02	\$23.71	\$22.65	79			
			RG59*, RG62*	PE4739	\$24.37	\$23.15	\$21.93	\$20.96	80			
			RG174, RG316, RG188	PE4742	\$26.34	\$25.02	\$23.71	\$22.65	81			
		Clamp/Solder	RG213, RG214, RG8, RG9, RG225, RG393	PE4735	\$37.72	\$35.83	\$33.95	\$32.44	82			
			RG55, RG58, RG141, RG142, RG223, RG400	PE4736	\$36.57	\$34.74	\$32.91	\$31.45	83			
			RG59*, RG62*, RG71	PE4740	\$30.17	\$28.66	\$27.15	\$25.95	84			
			RG174, RG316, RG188	PE4741	\$30.37	\$28.85	\$27.33	\$26.12	85			
			RG178, RG196	PE4743	\$30.37	\$28.85	\$27.33	\$26.12	86			
			PE-SR402AL, PE-SR402FL, RG402	PE4744	\$23.41	\$22.24	\$21.07	\$20.13	87			
			PE-SR405AL, PE-SR405FL, RG405	PE4745	\$23.67	\$22.49	\$21.30	\$20.36	88			
			Female, Bulkhead Mount									
			Cable Connectors		Crimp/Solder	RG55, RG141, RG142, RG223, RG400 with .480 inch D Hole	PE4747	\$25.29	\$24.03	\$22.76	\$21.75	89
RG58 with .480 inch D Hole	PE4748	\$26.64				\$25.31	\$23.98	\$22.91	90			
.100 inch, RG316, RG174, RG188, LMR-100, LMR-100A, LMR-100A-FR, PE-C100, PE-B100 with .480 inch D Hole	PE4752	\$27.69				\$26.31	\$24.92	\$23.81	91			
	Clamp/Solder	RG55, RG58, RG141, RG142, RG223, RG400 with .480 inch D Hole		PE4746	\$38.33	\$36.41	\$34.50	\$32.96	92			
		RG59*, RG62* with .480 inch D Hole		PE4749	\$34.27	\$32.56	\$30.84	\$29.47	93			
		RG174, RG316, RG188 with .480 inch D Hole		PE4751	\$22.56	\$21.43	\$20.30	\$19.40	94			
Terminal		Solder	PE-SR405AL, PE-SR405FL, RG405 with .480 inch D Hole	PE4755	\$25.78	\$24.49	\$23.20	\$22.17	95			
			Solder Cup with .410 inch D Hole	PE4757	\$16.10	\$15.30	\$14.49	\$13.85	96			
			Solder Cup with .350 inch D Hole	PE4758	\$14.63	\$13.90	\$13.17	\$12.58	97			
Terminal		Solder	Solder Cup with .480 inch D Hole	PE4764	\$23.38	\$22.21	\$21.04	\$20.11	98			
			Female, 4 Hole Flange Mount									
			Cable Connectors		Clamp/Solder	RG55, RG58, RG141, RG142, RG223, RG400 with .500 inch Threaded Hole Spacing	PE4765	\$30.17	\$28.66	\$27.15	\$25.95	99
Terminal		Solder				Solder Cup with .500 inch Threaded Hole Spacing	PE4756	\$25.32	\$24.05	\$22.79	\$21.78	1
			Solder Cup with .500 inch Hole Spacing	PE4763	\$25.33	\$24.06	\$22.80	\$21.78	2			
Female Right Angle, Bulkhead Mount												
Terminal		Solder	Solder Cup with .361 inch D Hole	PE4759	\$45.28	\$43.02	\$40.75	\$38.94	3			
Female Right Angle, 4 Hole Flange Mount												
Terminal		Solder	Solder Cup with .531 inch Hole Spacing	PE4760	\$43.15	\$40.99	\$38.84	\$37.11	4			

C Connectors











Connection Method	Product Image	Attachment Cable/Contact	Coax Type / Termination Type	Model No.	PRICE				ROW
					1-24	25-49	50-99	100 +	
Male									
Cable Connectors		Crimp/Solder	RG214, RG9, RG225, RG393	PE4375	\$27.18	\$25.82	\$24.46	\$23.37	5
			RG55, RG141, RG142, RG223, RG400	PE4445	\$28.38	\$26.96	\$25.54	\$24.41	6
			RG58, RG303, RG141, PE-C195, PE-P195, LMR-195, .195 inch	PE4517	\$37.78	\$35.89	\$34.00	\$32.49	7

* Fits MIL-C-17 and equivalent cable versions only

Connectors

See Our Website For Current Pricing & Real-Time Stock Availability!

C Connectors







Connection Method	Product Image	Attachment Cable/Contact	Coax Type / Termination Type	Model No.	PRICE				ROW
					1-24	25-49	50-99	100 +	
Male									
Cable Connectors		Crimp/Solder	RG213, RG8	PE4518	\$35.67	\$33.89	\$32.10	\$30.68	8
		Clamp/Solder	RG55, RG58, RG141, RG142, RG223, RG303, RG400, PE-C195, PE-P195, LMR-195	PE4242	\$49.46	\$46.99	\$44.51	\$42.54	9
			RG213, RG214, RG8, RG9, RG11*, RG225, RG393, RG144*, RG216*, RG215	PE4243	\$43.08	\$40.93	\$38.77	\$37.05	10
			RG213, RG214, RG8, RG9, RG11*, RG225, RG393, RG144*, RG216*, RG215	PE4950	\$48.57	\$46.14	\$43.71	\$41.77	11
			RG14, RG217	PE4951	\$55.99	\$53.19	\$50.39	\$48.15	12
			RG59*, RG62*, RG71	PE4952	\$49.60	\$47.62	\$46.13	\$45.14	13
			RG174, RG316, RG188	PE4953	\$35.67	\$33.89	\$32.10	\$30.68	14
RG218	PE4954	\$89.84	\$85.35	\$80.86	\$77.26	15			
Male, 4 Hole Flange Mount									
Terminal		Solder	Solder Cup with .718 inch Hole Spacing	PE44096	\$69.82	\$66.33	\$62.84	\$60.05	16
Male Right Angle									
Cable Connectors		Crimp/Solder	RG214, RG9, RG225, RG393	PE4949	\$84.19	\$79.98	\$75.77	\$72.40	17
			RG213, RG8	PE4955	\$72.23	\$68.62	\$65.01	\$62.12	18
			RG55, RG141, RG142, RG223, RG400	PE4958	\$69.01	\$65.56	\$62.11	\$59.35	19
		Clamp/Solder	PE-P195, PE-C195, RG58, RG141, RG303, .195 inch, LMR-195	PE4959	\$86.99	\$82.64	\$78.29	\$74.81	20
			RG213, RG214, RG8, RG9, RG11*, RG225, RG393, RG144*, RG216*, RG215	PE4244	\$70.50	\$66.98	\$63.45	\$60.63	21
			RG55, RG58, RG141, RG142, RG223, RG303, RG400, PE-C195, PE-P195, LMR-195	PE4957	\$90.20	\$85.69	\$81.18	\$77.57	22
Female									
Cable Connectors		Clamp/Solder	RG213, RG214, RG8, RG9, RG11*, RG225, RG393, RG144*, RG216*, RG215	PE4960	\$55.79	\$53.00	\$50.21	\$47.98	23
			RG55, RG58, RG141, RG142, RG223, RG303, RG400, PE-C195, PE-P195, LMR-195	PE4961	\$80.81	\$76.77	\$72.73	\$69.50	24
			RG59*, RG62*	PE4962	\$38.01	\$36.11	\$34.21	\$32.69	25
			RG14, RG217	PE4963	\$70.58	\$67.05	\$63.52	\$60.70	26
Female, Bulkhead Mount									
Cable Connectors		Clamp/Solder	RG59*, RG62* with .596 inch D Hole	PE44098	\$31.53	\$29.95	\$28.38	\$27.12	27
			RG58, RG142, RG223, RG400, RG141, RG303, RG55, LMR-400, PE-C195, PE-P195 with .596 inch D Hole	PE44099	\$70.65	\$67.12	\$63.59	\$60.76	28
			RG214, RG213, RG393, RG8, RG225, RG11*, RG216*, RG144*, RG215, RG9 with .720 inch D Hole	PE4964	\$67.06	\$63.71	\$60.35	\$57.67	29
			RG58, RG55, RG141, RG142, RG223, RG400 with .720 inch D Hole	PE4965	\$79.06	\$75.11	\$71.15	\$67.99	30
Terminal		Solder	Solder Cup with .720 inch D Hole	PE4240	\$53.90	\$51.74	\$50.13	\$49.05	31
			Solder Cup with .720 inch D Hole	PE4971	\$75.52	\$71.74	\$67.97	\$64.95	32
			Solder Cup with .720 inch D Hole	PE4972	\$75.52	\$71.74	\$67.97	\$64.95	33
			Turret with .350 inch D Hole	PE4973	\$79.33	\$75.36	\$71.40	\$68.22	34
Female, 4 Hole Flange Mount									
Cable Connectors		Crimp/Solder	RG214, RG9, RG225, RG393 with .718 inch Hole Spacing	PE4374	\$67.28	\$63.92	\$60.55	\$57.86	35
			RG214, RG213, RG393, RG8, RG225, RG11*, RG216*, RG144*, RG215, RG9 with .718 inch Hole Spacing	PE4967	\$80.07	\$76.07	\$72.06	\$68.86	36
		Clamp/Solder	RG58, RG142, RG223, RG400, RG141, RG303, RG55, LMR-400, PE-C195, PE-P195 with .718 inch Hole Spacing	PE4969	\$58.37	\$55.45	\$52.53	\$50.20	37
			RG59*, RG62* with .718 inch Hole Spacing	PE4970	\$67.93	\$64.53	\$61.14	\$58.42	38
			RG213, RG214, RG393, RG11*	PE4CO1013	\$72.98	\$69.33	\$65.68	\$62.76	39
Terminal		Solder	Solder Cup with .718 inch Hole Spacing	PE4241	\$22.08	\$20.98	\$19.87	\$18.99	40

* Fits MIL-C-17 and equivalent cable versions only

Connectors



See Our Website For Current Pricing & Real-Time Stock Availability!

D-Sub Connectors

Connection Method	Product Image	Attachment Cable/Contact	Coax Type / Termination Type	Model No.	PRICE				ROW
					1-24	25-49	50-99	100 +	
Plug									
Cable Connectors		Crimp/Solder	PE-C195, PE-P195, RG58, RG141, RG303, LMR-195, .195 inch	PE4808	\$15.50	\$14.73	\$13.95	\$13.33	41
			RG174, RG316, RG188, .100 inch, PE-B100, PE-C100, LMR-100	PE4809	\$23.46	\$22.29	\$21.11	\$20.18	42
		Solder/Solder	RG58, RG141, RG303	PE4812	\$12.76	\$12.12	\$11.48	\$10.97	43
			RG180, RG195, PE-B150	PE4815	\$18.31	\$17.39	\$16.48	\$15.75	44
Plug Right Angle									
Cable Connectors		Crimp/Solder	RG55, RG142, RG223, RG400	PE44035	\$13.77	\$13.08	\$12.39	\$11.84	45
		Solder/Solder	PE-SR405AL, PE-SR405FL, RG405	PE44038	\$20.91	\$20.07	\$19.45	\$19.03	46
Receptacle									
Cable Connectors		Crimp/Solder	PE-C195, PE-P195, RG58, RG141, RG303, LMR-195, .195 inch	PE4800	\$15.48	\$14.71	\$13.93	\$13.31	47
			RG174, RG316, RG188, .100 inch, PE-B100, PE-C100, LMR-100	PE4801	\$17.03	\$16.18	\$15.33	\$14.65	48
		Solder/Solder	RG58, RG141, RG303	PE4804	\$13.12	\$12.46	\$11.81	\$11.28	49
			RG180, RG195	PE4807	\$8.19	\$7.78	\$7.37	\$7.04	50
Receptacle Right Angle									
Cable Connectors		Crimp/Solder	RG58, RG141, RG303	PE4816	\$25.68	\$24.65	\$23.88	\$23.37	51

Connectors





FAKRA Connectors

Connection Method	Product Image	Attachment Cable/Contact	Coax Type / Termination Type	Model No.	PRICE				ROW
					1-24	25-49	50-99	100 +	
Plug									
Cable Connectors		Crimp/Solder	RG174, RG316, RG188, .100 inch, PE-B100, PE-C100, LMR-100 with Black Color	PE45404A	\$5.38	\$5.11	\$4.84	\$4.63	52
			RG174, RG316, RG188, .100 inch, PE-B100, PE-C100, LMR-100 with White Color	PE45404B	\$5.38	\$5.00	\$4.63	\$4.30	53
			RG174, RG316, RG188, .100 inch, PE-B100, PE-C100, LMR-100 with Blue Color	PE45404C	\$5.38	\$5.11	\$4.84	\$4.63	54
			RG174, RG316, RG188, .100 inch, PE-B100, PE-C100, LMR-100 with Bordeaux Color	PE45404D	\$5.38	\$5.11	\$4.84	\$4.63	55
			RG174, RG316, RG188, .100 inch, PE-B100, PE-C100, LMR-100 with Violet Color	PE45404H	\$5.38	\$5.11	\$4.84	\$4.63	56
			RG174, RG316, RG188, .100 inch, PE-B100, PE-C100, LMR-100 with Beige Color	PE45404I	\$5.38	\$5.11	\$4.84	\$4.63	57
			RG174, RG316, RG188, .100 inch, PE-B100, PE-C100, LMR-100 with Curry Color	PE45404K	\$5.38	\$5.11	\$4.84	\$4.63	58
			RG174, RG316, RG188, .100 inch, PE-B100, PE-C100, LMR-100 with Water Blue Color	PE45404Z	\$5.38	\$5.11	\$4.84	\$4.63	59
PCB Mount		Solder	Thru Hole with Black Color	PE44649A	\$6.04	\$5.74	\$5.44	\$5.19	60
			Thru Hole with White Color	PE44649B	\$2.96	\$2.81	\$2.66	\$2.55	61
			Thru Hole with Blue Color	PE44649C	\$6.04	\$5.74	\$5.44	\$5.19	62
			Thru Hole with Bordeaux Color	PE44649D	\$3.39	\$3.22	\$3.05	\$2.92	63
			Thru Hole with Violet Color	PE44649H	\$2.96	\$2.81	\$2.66	\$2.55	64
			Thru Hole with Beige Color	PE44649I	\$4.77	\$4.53	\$4.29	\$4.10	65
			Thru Hole with Curry Color	PE44649K	\$2.96	\$2.81	\$2.66	\$2.55	66
			Thru Hole with Water Blue Color	PE44649Z	\$6.23	\$5.92	\$5.61	\$5.36	67



See Our Website For Current Pricing & Real-Time Stock Availability!

* Fits MIL-C-17 and equivalent cable versions only

FAKRA Connectors

Connection Method	Product Image	Attachment Cable/Contact	Coax Type / Termination Type	Model No.	PRICE				ROW
					1-24	25-49	50-99	100 +	
Plug Right Angle									
PCB Mount		Solder	Thru Hole with Black Color	PE44651A	\$8.46	\$8.04	\$7.61	\$7.28	68
			Thru Hole with White Color	PE44651B	\$5.09	\$4.84	\$4.58	\$4.38	69
			Thru Hole with Blue Color	PE44651C	\$8.46	\$8.04	\$7.61	\$7.28	70
			Thru Hole with Bordeaux Color	PE44651D	\$7.54	\$7.16	\$6.79	\$6.48	71
			Thru Hole with Violet Color	PE44651H	\$6.48	\$6.16	\$5.83	\$5.57	72
			Thru Hole with Beige Color	PE44651I	\$6.48	\$6.16	\$5.83	\$5.57	73
			Thru Hole with Curry Color	PE44651K	\$6.73	\$6.39	\$6.06	\$5.79	74
Thru Hole with Water Blue Color	PE44651Z	\$7.78	\$7.39	\$7.00	\$6.69	75			
Jack									
Cable Connectors		Crimp/Solder	RG188-DS, RG316-DS with Black Color	PE45176	\$5.29	\$5.03	\$4.76	\$4.55	76
			RG174, RG316, RG188, .100 inch, PE-B100, PE-C100, LMR-100 with Black Color	PE44646A	\$6.95	\$6.60	\$6.26	\$5.98	77
			RG174, RG316, RG188, .100 inch, PE-B100, PE-C100, LMR-100 with White Color	PE44646B	\$6.95	\$6.60	\$6.26	\$5.98	78
			RG174, RG316, RG188, .100 inch, PE-B100, PE-C100, LMR-100 with Blue Color	PE44646C	\$6.95	\$6.60	\$6.26	\$5.98	79
			RG174, RG316, RG188, .100 inch, PE-B100, PE-C100, LMR-100 with Bordeaux Color	PE44646D	\$6.04	\$5.74	\$5.44	\$5.19	80
			RG174, RG316, RG188, .100 inch, PE-B100, PE-C100, LMR-100 with Violet Color	PE44646H	\$6.95	\$6.60	\$6.26	\$5.98	81
			RG174, RG316, RG188, .100 inch, PE-B100, PE-C100, LMR-100 with Beige Color	PE44646J	\$6.20	\$5.89	\$5.58	\$5.33	82
			RG174, RG316, RG188, .100 inch, PE-B100, PE-C100, LMR-100 with Curry Color	PE44646K	\$6.95	\$6.60	\$6.26	\$5.98	83
			RG174, RG316, RG188, .100 inch, PE-B100, PE-C100, LMR-100 with Water Blue Color	PE44646Z	\$6.40	\$6.08	\$5.76	\$5.50	84
Jack Right Angle									
Cable Connectors		Crimp/Solder	RG174, RG316, RG188, .100 inch, PE-B100, PE-C100, LMR-100 with Black Color	PE44648A	\$8.46	\$8.04	\$7.61	\$7.28	85
			RG174, RG316, RG188, .100 inch, PE-B100, PE-C100, LMR-100 with White Color	PE44648B	\$8.46	\$8.04	\$7.61	\$7.28	86
			RG174, RG316, RG188, .100 inch, PE-B100, PE-C100, LMR-100 with Blue Color	PE44648C	\$8.46	\$8.04	\$7.61	\$7.28	87
			RG174, RG316, RG188, .100 inch, PE-B100, PE-C100, LMR-100 with Bordeaux Color	PE44648D	\$6.73	\$6.39	\$6.06	\$5.79	88
			RG174, RG316, RG188, .100 inch, PE-B100, PE-C100, LMR-100 with Violet Color	PE44648H	\$7.54	\$7.16	\$6.79	\$6.48	89
			RG174, RG316, RG188, .100 inch, PE-B100, PE-C100, LMR-100 with Beige Color	PE44648I	\$4.87	\$4.63	\$4.38	\$4.19	90
			RG174, RG316, RG188, .100 inch, PE-B100, PE-C100, LMR-100 with Curry Color	PE44648K	\$7.54	\$7.16	\$6.79	\$6.48	91
			RG174, RG316, RG188, .100 inch, PE-B100, PE-C100, LMR-100 with Water Blue Color	PE44648Z	\$8.16	\$7.75	\$7.34	\$7.02	92
			PCB Mount		Solder	Thru Hole with Black Color	PE44650A	\$4.95	\$4.70
Thru Hole with White Color	PE44650B	\$6.91				\$6.56	\$6.22	\$5.94	94
Thru Hole with Blue Color	PE44650C	\$6.02				\$5.72	\$5.42	\$5.18	95
Thru Hole with Bordeaux Color	PE44650D	\$5.04				\$4.79	\$4.54	\$4.33	96
Thru Hole with Violet Color	PE44650H	\$4.22				\$4.01	\$3.80	\$3.63	97
Thru Hole with Beige Color	PE44650I	\$5.09				\$4.84	\$4.58	\$4.38	98
Thru Hole with Curry Color	PE44650K	\$4.84				\$4.60	\$4.36	\$4.16	99
Thru Hole with Water Blue Color	PE44650Z	\$8.83	\$8.39	\$7.95	\$7.59	1			

FME Connectors

Connection Method	Product Image	Attachment Cable/Contact	Coax Type / Termination Type	Model No.	PRICE				ROW
					1-24	25-49	50-99	100 +	
Plug									
Cable Connectors		Crimp/Solder	RG58	PE44295	\$12.83	\$12.19	\$11.55	\$11.03	2
			RG55, RG142, RG223, RG400	PE44296	\$10.54	\$10.01	\$9.49	\$9.06	3
			RG174, RG316, RG188	PE44297	\$11.64	\$11.06	\$10.48	\$10.01	4
Plug, Bulkhead Mount									
Terminal		Solder	Solder Cup with .350 inch D Hole	PE44149	\$8.12	\$7.71	\$7.31	\$6.98	5

* Fits MIL-C-17 and equivalent cable versions only



Connectors

See Our Website For Current Pricing & Real-Time Stock Availability!







FME Connectors

Connection Method	Product Image	Attachment Cable/Contact	Coax Type / Termination Type	Model No.	PRICE				ROW
					1-24	25-49	50-99	100 +	
	Jack								
Cable Connectors		Crimp/Solder	RG58, RG303, RG141, PE-C195, PE-P195, LMR-195, .195 inch	PE44146	\$9.81	\$9.32	\$8.83	\$8.44	6
			RG55, RG142, RG223, RG400	PE44147	\$8.44	\$8.02	\$7.60	\$7.26	7
			RG174, RG316, RG188	PE44148	\$12.02	\$11.42	\$10.82	\$10.34	8

GR874 Connectors

Connection Method	Product Image	Attachment Cable/Contact	Coax Type / Termination Type	Model No.	PRICE				ROW
					1-24	25-49	50-99	100 +	
	Sexless								
Cable Connectors		Crimp/Solder	RG55, RG58, RG141, RG142, RG223, RG400	PE4233	\$27.69	\$26.31	\$24.92	\$23.81	9
			RG214, RG9, RG225, RG393	PE4352	\$86.99	\$82.64	\$78.29	\$74.81	10
		Accessories		PE4348	\$47.35	\$44.98	\$42.62	\$40.72	11

HN Connectors





Connection Method	Product Image	Attachment Cable/Contact	Coax Type / Termination Type	Model No.	PRICE				ROW
					1 Pc.	See Web for Volume Pricing			
	Male								
Cable Connectors		Crimp/Solder	RG213, RG215, RG8	PE4473	\$42.07				12
			RG214, RG9, RG225, RG393	PE4474	\$42.75				13
			RG55, RG142, RG223, RG400, RG141	PE4477	\$36.33				14
			RG58, RG141	PE4478	\$34.31				15
		Clamp/Solder	RG213, RG214, RG8, RG9, RG225, RG393	PE4182	\$25.96		See Web for Volume Pricing		16
			RG58, RG55, RG141, RG142, RG223, RG400, RG303, PE-C195, PE-P195, LMR-195	PE4198	\$35.21			17	
			RG14, RG217	PE4475	\$46.45			18	
			RG17, RG218, RG219	PE4476	\$127.55			19	
			RG59*, RG62*, RG71	PE4479	\$52.67			20	
	Male Right Angle								
Cable Connectors		Clamp/Solder	RG213, RG8, RG393, RG225, RG214, RG393, RG9	PE4230	\$61.29				21
			RG55, RG58, RG141, RG142, RG223, RG303, RG400, PE-C195, PE-P195, LMR-195	PE4480	\$76.07				22
			RG14, RG217	PE45307	\$75.52				23
	Female								
Cable Connectors		Clamp/Solder	RG213, RG8, RG225, RG214, RG393	PE4229	\$58.04		See Web for Volume Pricing		24
			RG401, PE-SR401AL, PE-SR401FL	PE4229-401	\$55.86				25
	Female, Bulkhead Mount								
Terminal		Solder	Turret with .765 inch DD Hole	PE4481	\$63.11				26
	Female, 4 Hole Flange Mount								
Terminal		Solder	Solder Cup with .906 inch Hole Spacing	PE4183	\$31.16		See Web for Volume Pricing		27
		Field Replaceable	Slotted Contact	PE44718	\$62.30				28

Connectors



See Our Website For Current Pricing & Real-Time Stock Availability!

* Fits MIL-C-17 and equivalent cable versions only





LC Connectors

Connection Method	Product Image	Attachment Cable/Contact	Coax Type / Termination Type	Model No.	PRICE				ROW
					1 Pc.	See Web for Volume Pricing			
Male									
Cable Connectors		Clamp/Solder	RG218, RG219, RG17	PE4323	\$216.52				29
			RG14, RG217	PE4563	\$190.30				30
			RG213, RG214, RG8, RG9, RG225, RG393, RG215	PE4564	\$160.70				31
			RG55, RG58, RG141, RG142, RG223, RG303, RG400, PE-C195, PE-P195, LMR-195	PE4565	\$150.45				32
Male Right Angle									
Cable Connectors		Clamp/Solder	RG213, RG214, RG8, RG9, RG225, RG393, RG215	PE44447	\$249.43		See Web for Volume Pricing		33
Female									
Cable Connectors		Clamp/Solder	RG213, RG214, RG8, RG9, RG225, RG393, RG215	PE44450	\$210.62				34
			RG17, RG218, RG219	PE44451	\$269.43				35
Female, 4 Hole Flange Mount									
Terminal		Solder	Pin with 1.44 inch Hole Spacing	PE4192	\$108.19				36
			Pin	PE45519	\$178.00				37

MC-Card Connectors









Connection Method	Product Image	Attachment Cable/Contact	Coax Type / Termination Type	Model No.	PRICE				ROW
					1-24	25-49	50-99	100 +	
Plug									
Cable Connectors		Crimp/Solder	RG174, RG316, RG188	PE44309	\$11.02	\$10.47	\$9.92	\$9.48	38
			RG178, RG196	PE44310	\$11.02	\$10.47	\$9.92	\$9.48	39
			RG188-DS, RG316-DS	PE45169	\$10.89	\$10.35	\$9.80	\$9.37	40
Plug Right Angle									
Cable Connectors		Crimp/Solder	RG174, RG316, RG188, LMR-100, PE-B100, PE-C100, .100 inch	PE44308	\$13.00	\$12.35	\$11.70	\$11.18	41
			RG178, RG196	PE44311	\$14.35	\$13.63	\$12.92	\$12.34	42
			RG188-DS, RG316-DS	PE45168	\$11.61	\$11.03	\$10.45	\$9.98	43

MCX Connectors





Connection Method	Product Image	Attachment Cable/Contact	Coax Type / Termination Type	Model No.	PRICE				ROW
					1-24	25-49	50-99	100 +	
Plug									
Cable Connectors		Crimp/Solder	RG316, RG174, RG188, LMR-100, PE-B100, PE-C100, .100 inch	PE4551	\$13.00	\$12.35	\$11.70	\$11.18	44
			RG178, RG196	PE4552	\$18.69	\$17.76	\$16.82	\$16.07	45
			RG188-DS, RG316-DS	PE4878	\$13.05	\$12.40	\$11.75	\$11.22	46
			RG58	PE4880	\$23.27	\$22.34	\$21.64	\$21.18	47
			RG55, RG141, RG142, RG223, RG400	PE4881	\$29.52	\$28.34	\$27.45	\$26.86	48
PCB Mount		Solder	Surface Mount	PE44613	\$16.41	\$15.59	\$14.77	\$14.11	49
Cable Connectors			Thru Hole with .200 inch x .052 inch Hole Spacing	PE4559	\$21.42	\$20.35	\$19.28	\$18.42	50
		PE-SR405AL, PE-SR405FL, PE-SR405FLJ, PE-SR405TN, RG405	PE4876	\$22.93	\$21.78	\$20.64	\$19.72	51	
Plug Right Angle									
Cable Connectors		Crimp/Solder	RG174, RG316, RG188, LMR-100, PE-B100, PE-C100, .100 inch	PE4553	\$15.80	\$15.01	\$14.22	\$13.59	52
			RG178, RG196	PE4554	\$17.62	\$16.74	\$15.86	\$15.15	53
			RG188-DS, RG316-DS	PE4879	\$15.91	\$15.11	\$14.32	\$13.68	54
			RG58, RG303, RG141, PE-C195, PE-P195, LMR-195, .195 inch	PE4882	\$19.80	\$18.81	\$17.82	\$17.03	55
			RG55, RG142, RG223, RG400	PE4883	\$15.96	\$15.16	\$14.36	\$13.73	56
		Solder/Solder	PE-SR405AL, PE-SR405FL, PE-SR405FLJ, PE-SR405TN, RG405	PE44698	\$8.42	\$8.00	\$7.58	\$7.24	57

* Fits MIL-C-17 and equivalent cable versions only

MCX Connectors

Connection Method	Product Image	Attachment Cable/Contact	Coax Type / Termination Type	Model No.	PRICE				ROW
					1-24	25-49	50-99	100 +	
PCB Mount		Solder	Thru Hole with .200 inch x .067 inch Hole Spacing	PE44830	\$17.60	\$16.90	\$16.37	\$16.02	58
Cable Connectors			PE-SR405AL, PE-SR405FL, PE-SR405FLJ, PE-SR405TN, RG405	PE4877	\$24.38	\$23.16	\$21.94	\$20.97	59
Jack									
Cable Connectors		Crimp/Solder	RG174, RG316, RG188, PE-B100, PE-C100, .100 inch, LMR-100	PE4562	\$22.44	\$21.32	\$20.20	\$19.30	60
			RG178, RG196	PE4884	\$29.27	\$27.81	\$26.34	\$25.17	61
			RG188-DS, RG316-DS	PE4885	\$18.66	\$17.73	\$16.79	\$16.05	62
PCB Mount		Solder	Thru Hole with .200 inch x .067 inch Hole Spacing	PE44303	\$16.96	\$16.11	\$15.26	\$14.59	63
			Surface Mount	PE44660	\$31.66	\$30.08	\$28.49	\$27.23	64
			End Launch	PE44661	\$20.87	\$19.83	\$18.78	\$17.95	65
			Thru Hole with .200 inch x .052 inch Hole Spacing	PE4555	\$13.25	\$12.59	\$11.93	\$11.40	66
			Surface Mount	PE4889	\$15.79	\$15.00	\$14.21	\$13.58	67
			.062 inch End Launch	PE4892	\$13.34	\$12.67	\$12.01	\$11.47	68
.042 inch End Launch	PE4893	\$23.48	\$22.31	\$21.13	\$20.19	69			
Jack, Bulkhead Mount									
Cable Connectors		Crimp/Solder	RG178, RG196 with .177 inch D Hole	PE4886	\$23.73	\$22.54	\$21.36	\$20.41	70
			RG174, RG316, RG188, LMR-100, PE-B100, PE-C100, .100 inch with .177 inch D Hole	PE4887	\$21.66	\$20.58	\$19.49	\$18.63	71
			RG188-DS, RG316-DS with .177 inch D Hole	PE4888	\$16.75	\$15.91	\$15.08	\$14.41	72
Terminal		Solder	Turret with .177 inch D Hole	PE4561	\$18.65	\$17.72	\$16.79	\$16.04	73
Jack, 2 Hole Flange Mount									
Terminal		Solder	Solder Cup with .328 inch Hole Spacing	PE4891	\$27.24	\$25.88	\$24.52	\$23.43	74
			Pin with .328 inch Hole Spacing	PE4894	\$26.17	\$24.86	\$23.55	\$22.51	75
Jack Right Angle									
PCB Mount		Solder	Thru Hole with .200 inch x .052 inch Hole Spacing	PE45274	\$14.83	\$14.09	\$13.35	\$12.75	76
			Thru Hole with .200 inch x .052 inch Hole Spacing	PE4556	\$16.34	\$15.52	\$14.71	\$14.05	77
			Surface Mount	PE4890	\$21.91	\$20.81	\$19.72	\$18.84	78
Jack Right Angle, Bulkhead Mount									
Terminal		Solder	Turret with .177 inch D Hole	PE4560	\$45.26	\$43.00	\$40.73	\$38.92	79

Reverse Polarity MCX Connectors

Connection Method	Product Image	Attachment Cable/Contact	Coax Type / Termination Type	Model No.	PRICE				ROW
					1-24	25-49	50-99	100 +	
Plug									
Cable Connectors		Crimp/Solder	RG174, RG316, RG188, .100 inch, PE-B100, PE-C100, LMR-100	PE44369	\$24.37	\$23.15	\$21.93	\$20.96	80
			RG178, RG196	PE44370	\$23.70	\$22.52	\$21.33	\$20.38	81
Plug Right Angle									
Cable Connectors		Crimp/Solder	RG316, RG188, RG174	PE45050	\$8.20	\$7.79	\$7.38	\$7.05	82
			RG178, RG196	PE45051	\$7.38	\$7.08	\$6.86	\$6.72	83
Jack, Bulkhead Mount									
Cable Connectors		Crimp/Solder	RG174, RG316, RG188 with .177 inch D Hole	PE44373	\$28.69	\$27.26	\$25.82	\$24.67	84
			RG178, RG196 with .177 inch D Hole	PE44374	\$29.81	\$28.32	\$26.83	\$25.64	85
PCB Mount		Solder	End Launch with .177 inch D Hole	PE44377	\$27.92	\$26.52	\$25.13	\$24.01	86

* Fits MIL-C-17 and equivalent cable versions only









Connectors

See Our Website For Current Pricing & Real-Time Stock Availability!

Reverse Polarity MCX Connectors

Connection Method	Product Image	Attachment Cable/Contact	Coax Type / Termination Type	Model No.	PRICE				ROW
					1-24	25-49	50-99	100 +	
Jack Right Angle, Bulkhead Mount									
PCB Mount		Solder	Thru Hole with .177 inch D Hole	PE44376	\$31.35	\$29.78	\$28.22	\$26.96	87

MHV Connectors





Connection Method	Product Image	Attachment Cable/Contact	Coax Type / Termination Type	Model No.	PRICE				ROW
					1 Pc.	See Web for Volume Pricing			
Male									
Cable Connectors		Crimp/Solder	RG59*, RG62*, RG71	PE4075	\$16.37	See Web for Volume Pricing			88
			RG58, RG303, RG141, PE-C195, PE-P195, LMR-195, .195 inch	PE4093	\$26.13				89
			RG214, RG9, RG225, RG393	PE4350	\$36.13				90
			RG213, RG8	PE4493	\$32.66				91
			RG55, RG141, RG142, RG223, RG400	PE4657	\$19.69				92
			RG174, RG316, RG188, LMR-100, PE-B100, PE-C100, .100 inch	PE4933	\$42.01				93
		Clamp/Solder	RG58, RG55, RG141, RG142, RG223, RG400, RG303, PE-C195, PE-P195, LMR-195	PE4076	\$15.30				94
			RG59*, RG62*, RG71	PE4098	\$16.19				95
			RG213, RG214, RG8, RG9, RG11*, RG225, RG393, RG144*, RG216*, RG215	PE4299	\$31.69				96
			RG174, RG316, RG188	PE4494	\$16.98				97
Male Right Angle									
Cable Connectors		Clamp/Solder	RG58, RG55, RG141, RG142, RG223, RG400, RG303, PE-C195, PE-P195, LMR-195	PE4226	\$35.60				98
			RG59*, RG62*, RG71	PE4227	\$31.60				99
			RG213, RG214, RG8, RG9, RG11*, RG225, RG393	PE4709	\$61.20				1
			RG174, RG316, RG188	PE4710	\$34.31				2
Female									
Cable Connectors		Crimp/Solder	RG55, RG141, RG142, RG223, RG400	PE44100	\$27.34	See Web for Volume Pricing			3
			PE-P195, PE-C195, RG58, RG141, RG303, .195 inch, LMR-195	PE44102	\$29.09				4
			RG59*, RG62*	PE44103	\$35.42				5
		Clamp/Solder	RG59*, RG62*, RG71	PE4181	\$23.45				6
			RG58, RG55, RG141, RG142, RG223, RG400, RG303, PE-C195, PE-P195, LMR-195	PE4225	\$25.82				7
			RG174, RG316, RG188	PE44104	\$28.30				8
Female, Bulkhead Mount									
Cable Connectors		Crimp/Solder	RG55, RG141, RG142, RG223, RG400	PE44107	\$29.70	See Web for Volume Pricing			9
			RG58, RG303, RG141, PE-C195, PE-P195, LMR-195, .195 inch	PE44108	\$40.16				10
			RG59*, RG62*, RG71	PE44110	\$50.85				11
		Clamp/Solder	RG213, RG214, RG8, RG9, RG11*, RG225, RG393	PE44105	\$65.55				12
			RG55, RG58, RG141, RG142, RG223, RG303, RG400, PE-C195, PE-P195, LMR-195	PE44106	\$50.33				13
			RG59*, RG62*, RG71	PE44109	\$43.64				14
Terminal		Solder	Solder Cup with .380 inch DD Hole	PE4193	\$21.89				15
			Solder Cup with .380 inch DD Hole	PE4311	\$47.23				16
			Turret with .537 inch D Hole	PE4312	\$39.49				17
			Solder Cup	PE44896	\$115.57				18
			Solder Cup with .480 inch D Hole	PE4495	\$47.69				19
Female, 4 Hole Flange Mount									
Cable Connectors		Clamp/Solder	RG58, RG142, RG223, RG400, RG141, RG303, RG55, LMR-400, PE-C195, PE-P195 with .500 inch Threaded Hole Spacing	PE4313	\$46.99				21
			RG59*, RG62*, RG71 with .500 inch Threaded Hole Spacing	PE4314	\$50.77				22
			RG214, RG213, RG393, RG8, RG225, RG11*, RG216*, RG144*, RG215, RG9 with .718 inch Hole Spacing	PE44112	\$53.88				23
Terminal		Solder	Solder Cup with .500 inch Threaded Hole Spacing	PE4228	\$31.00				24
			Solder Cup	PE45035	\$57.92				25

* Fits MIL-C-17 and equivalent cable versions only

Connectors

See Our Website For Current Pricing & Real-Time Stock Availability!

Mini SMP Connectors

Connection Method	Product Image	Attachment Cable/Contact	Coax Type / Termination Type	Model No.	PRICE				ROW
					1-24	25-49	50-99	100 +	
Male									
PCB Mount		Solder	Surface Mount	PE44489	\$32.03	\$30.43	\$28.83	\$27.55	26
			End Launch	PE44490	\$27.06	\$25.71	\$24.35	\$23.27	27
			Edge Launch	PE44969	\$29.51	\$28.03	\$26.56	\$25.38	28
			Thru Hole	PE44970	\$55.91	\$53.11	\$50.32	\$48.08	29
Male, Solder									
Terminal		Solder	Pin	PE44973	\$38.53	\$36.60	\$34.68	\$33.14	30
Male Right Angle									
PCB Mount		Solder	Surface Mount	PE44968	\$67.99	\$64.59	\$61.19	\$58.47	31
Female									
Cable Connectors		Solder	PE-047SR, PE-SR047AL, PE-SR047FL	PE44491	\$39.49	\$37.52	\$35.54	\$33.96	32
			PE-SR405AL, PE-SR405FL, PE-SR405FLJ, PE-SR405TN, RG405	PE44492	\$38.96	\$37.01	\$35.06	\$33.51	33
			PE-047SR, PE-SR047FL	PE44971	\$44.90	\$42.66	\$40.41	\$38.61	34
			PE-SR405AL, PE-SR405FL, PE-SR405FLJ, PE-SR405TN, RG405	PE44974	\$35.72	\$33.93	\$32.15	\$30.72	35
Female Right Angle									
Cable Connectors		Solder	PE-047SR, PE-SR047AL, PE-SR047FL	PE44493	\$50.33	\$47.81	\$45.30	\$43.28	36
			PE-SR405AL, PE-SR405FL, PE-SR405FLJ, PE-SR405TN, RG405	PE44494	\$44.86	\$42.62	\$40.37	\$38.58	37
			PE-SR405AL, PE-SR405FL, PE-SR405FLJ, PE-SR405TN, RG405	PE44972	\$58.28	\$55.37	\$52.45	\$50.12	38

Mini UHF Connectors











Connection Method	Product Image	Attachment Cable/Contact	Coax Type / Termination Type	Model No.	PRICE				ROW
					1-24	25-49	50-99	100 +	
Male									
Cable Connectors		Crimp/Solder	RG58, RG303, RG141, PE-C195, PE-P195, LMR-195, .195 inch	PE4342	\$6.68	\$6.35	\$6.01	\$5.74	39
			RG55, RG141, RG142, RG223, RG400	PE44088	\$10.96	\$10.41	\$9.86	\$9.43	40
			RG174, RG316, RG188	PE44090	\$12.12	\$11.51	\$10.91	\$10.42	41
			RG55, RG141, RG142, RG223, RG400	PE4521	\$6.68	\$6.35	\$6.01	\$5.74	42
Female									
Cable Connectors		Crimp/Solder	RG55, RG141, RG142, RG223, RG400	PE44083	\$10.54	\$10.01	\$9.49	\$9.06	43
			RG58, RG303, RG141, PE-C195, PE-P195, LMR-195, .195 inch	PE44084	\$13.82	\$13.13	\$12.44	\$11.89	44
			RG174, RG316, RG188	PE44085	\$4.79	\$4.55	\$4.31	\$4.12	45
Female, Bulkhead Mount									
Cable Connectors		Crimp/Solder	RG55, RG141, RG142, RG223, RG400 with .410 inch D Hole	PE44086	\$12.86	\$12.22	\$11.57	\$11.06	46
			.195 inch, RG58, RG141, RG303, LMR-195, LMR-195-FR, PE-C195, PE-P195 with .410 inch D Hole	PE44087	\$15.73	\$14.94	\$14.16	\$13.53	47
Terminal		Solder	Solder Cup with .350 inch D Hole	PE44089	\$8.29	\$7.88	\$7.46	\$7.13	48
PCB Mount			Thru Hole with .380 inch Diameter	PE44092	\$11.31	\$10.74	\$10.18	\$9.73	49
Terminal			Solder Cup with .350 inch D Hole	PE4644	\$6.60	\$6.27	\$5.94	\$5.68	50
Female, 4 Hole Flange Mount									
Terminal		Solder	Solder Cup with .437 inch Hole Spacing	PE44091	\$11.37	\$10.80	\$10.23	\$9.78	51

Connectors



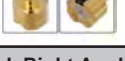

See Our Website For Current Pricing & Real-Time Stock Availability!

* Fits MIL-C-17 and equivalent cable versions only

MMCX Connectors

Connection Method	Product Image	Attachment Cable/Contact	Coax Type / Termination Type	Model No.	PRICE				ROW
					1-24	25-49	50-99	100 +	
	Plug								
Cable Connectors		Crimp/Solder	RG178, RG196	PE44645	\$17.12	\$16.26	\$15.41	\$14.72	52
			RG188-DS, RG316-DS	PE44874	\$18.01	\$17.11	\$16.21	\$15.49	53
			RG174, RG316, RG188, LMR-100, PE-B100, PE-C100, .100 inch	PE4896	\$16.24	\$15.43	\$14.62	\$13.97	54
		Solder	RG178, RG196	PE4897	\$15.84	\$15.05	\$14.26	\$13.62	55
			PE-SR405AL, PE-SR405FL, PE-SR405FLJ, PE-SR405TN, RG405	PE44453	\$19.05	\$18.10	\$17.15	\$16.38	56
PCB Mount		Solder	PE-047SR, PE-SR047AL, PE-SR047FL	PE44456	\$23.31	\$22.14	\$20.98	\$20.05	57
			End Launch	PE44663	\$22.55	\$21.42	\$20.30	\$19.39	58
	Thru Hole with .100 inch x .031 inch Hole Spacing								
				PE4905	\$26.64	\$25.31	\$23.98	\$22.91	59
	Plug Right Angle								
Cable Connectors		Crimp/Solder	RG316-DS, RG188-DS	PE44784	\$20.50	\$19.48	\$18.45	\$17.63	60
			RG174, RG316, RG188, LMR-100, PE-B100, PE-C100, .100 inch	PE4898	\$12.64	\$12.01	\$11.38	\$10.87	61
			RG178, RG196	PE4899	\$18.72	\$17.78	\$16.85	\$16.10	62
		Solder/Solder	PE-SR405AL, PE-SR405FL, PE-SR405FLJ, PE-SR405TN, RG405	PE44699	\$8.22	\$7.81	\$7.40	\$7.07	63
		Solder	PE-047SR, PE-SR047AL, PE-SR047FL	PE44457	\$24.34	\$23.12	\$21.91	\$20.93	64
	Jack								
Cable Connectors		Crimp/Solder	RG316-DS, RG188-DS	PE44852	\$18.09	\$17.19	\$16.28	\$15.56	65
			RG174, RG316, RG188, .100 inch, PE-B100, PE-C100, LMR-100	PE4901	\$16.31	\$15.49	\$14.68	\$14.03	66
			RG178, RG196	PE4902	\$16.31	\$15.49	\$14.68	\$14.03	67
		Solder	PE-SR405AL, PE-SR405FL, PE-SR405FLJ, PE-SR405TN, RG405	PE44458	\$29.13	\$27.67	\$26.22	\$25.05	68
			PE-047SR, PE-SR047AL, PE-SR047FL	PE44459	\$31.64	\$30.06	\$28.48	\$27.21	69
PCB Mount		Solder	Surface Mount	PE44662	\$20.87	\$19.83	\$18.78	\$17.95	70
			Thru Hole with .100 inch x .031 inch Hole Spacing	PE4904	\$13.92	\$13.22	\$12.53	\$11.97	71
	Jack Right Angle								
PCB Mount		Solder	Thru Hole with .100 inch x .031 inch Hole Spacing	PE4903	\$22.32	\$21.20	\$20.09	\$19.20	72

MMBX Connectors



Connection Method	Product Image	Attachment Cable/Contact	Coax Type / Termination Type	Model No.	PRICE				ROW
	Plug								
Cable Connectors		Crimp/Solder	RG178, RG196	PE45250	\$12.22				73
			RG316, RG174	PE45251	\$12.22				74
			RG316-DS, RG188-DS	PE45252	\$12.22				75
PCB Mount		Solder/Solder	Surface Mount	PE45259TR1	\$17.76				76
			Surface Mount	PE45259TR750	\$9,354.56				77
Cable Connectors		Solder/Non-Solder Contact	RG405, PE-SR405FL, PE-SR405FLJ	PE45253	\$13.72				78
	Plug Right Angle								
Cable Connectors		Crimp/Solder	RG178, RG196	PE45254	\$15.86				79
			RG316, RG174	PE45255	\$15.86				80
			RG316-DS, RG188-DS	PE45256	\$15.86				81

* Fits MIL-C-17 and equivalent cable versions only





Connectors

See Our Website For Current Pricing & Real-Time Stock Availability!

MMBX Connectors

Connection Method	Product Image	Attachment Cable/Contact	Coax Type / Termination Type	Model No.	PRICE				ROW
					1 Pc.	See Web for Volume Pricing			
Plug Right Angle									
Cable Connectors		Solder/Solder	RG405, PE-SR405FL, PE-SR405FLJ	PE45257	\$15.86				82
Jack									
PCB Mount		Solder	Edge Launch	PE45261	\$16.21	See Web for Volume Pricing			83
			Surface Mount	PE45262TR1	\$10.96				84
			Surface Mount	PE45262TR750	\$5,775.29				85
			Through Hole	PE45265TR1	\$13.26				86
			Through Hole	PE45265TR500	\$4,840.09				87
Jack, Thread-In									
Terminal		Solder	Pin	PE45267	\$12.32				88

N Connectors

Connection Method	Product Image	Attachment Cable/Contact	Coax Type / Termination Type	Model No.	PRICE				ROW
					1-24	25-49	50-99	100 +	
Male									
Cable Connectors		Crimp/Crimp	RG55, RG141, RG142, RG223, RG400	PE4042	\$17.42	\$16.55	\$15.68	\$14.98	89
			PE-C195, PE-P195, RG58, RG141, RG303, LMR-195, .195 inch	PE44520	\$10.72	\$10.18	\$9.65	\$9.22	90
		Crimp/Solder	RG214, RG9, RG225, RG393	PE4048	\$17.93	\$17.03	\$16.14	\$15.42	91
			RG58, RG141, RG303, LMR-195, PE-C195, PE-P195, .195 inch	PE4329	\$13.11	\$12.45	\$11.80	\$11.27	92
			RG8X, PE-C240, .240 inch, B7808A, LMR-240	PE4344	\$13.05	\$12.40	\$11.75	\$11.22	93
			RG174, RG316, RG188, LMR-100, PE-B100, PE-C100, .100 inch	PE4429	\$16.73	\$15.89	\$15.06	\$14.39	94
			RG213, RG215, RG8	PE4430	\$17.38	\$16.51	\$15.64	\$14.95	95
			RG59*, RG62*, RG71	PE4432	\$16.17	\$15.36	\$14.55	\$13.91	96
			PE-C600, LMR-600, LMR-600-DB, .600 inch	PE44454	\$33.00	\$31.68	\$30.69	\$30.03	97
			PE-C240, RG8X, .240 inch, LMR-240, LMR-240-DB, LMR-240-UF, B7808A	PE44521	\$15.79	\$15.00	\$14.21	\$13.58	98
			PE-C400, PE-B400, PE-B405, LMR-400, LMR-400-DB, LMR-400-UF, .400 inch	PE44522	\$18.52	\$17.59	\$16.67	\$15.93	99
			PE-C600, LMR-600, LMR-600-DB, .600 inch	PE44523	\$64.37	\$61.15	\$57.93	\$55.36	1
			RG223, RG142, RG400, RG55	PE44788	\$16.56	\$15.73	\$14.90	\$14.24	2
			PE-B400, PE-B405, PE-C400, LMR-400, .400 inch	PE4550	\$15.09	\$14.34	\$13.58	\$12.98	3
			RG178, RG196	PE4647	\$29.91	\$28.41	\$26.92	\$25.72	4
			LMR-195, PE-C195	TC-195-NMH-X	\$13.25	\$13.25	\$13.25	\$13.25	5
			LMR-200, PE-C200	TC-200-NMH-X	\$16.80	\$16.80	\$16.80	\$16.80	6
	LMR-240, PE-C240	TC-240-NMH-X	\$14.00	\$14.00	\$14.00	\$14.00	7		
	LMR-400, PE-C400, PE-B405	TC-400-NMH-X	\$14.00	\$14.00	\$14.00	\$14.00	8		
	LMR-600, PE-C600	TC-600-NMH-X	\$19.00	\$19.00	\$19.00	\$19.00	9		
		Clamp	7/8 inch Annular, 7/8 inch Helical, 7/8 inch Superflexible, 7/8 inch Flexible	PE44976	\$57.78	\$54.89	\$52.00	\$49.69	10
		Clamp/Solder	PE-SR402AL, PE-SR402FL, RG402	PE4006	\$20.50	\$19.48	\$18.45	\$17.63	11
			RG213, RG214, RG8, RG9, RG11*, RG225, RG393, RG144*, RG216*, RG215	PE4062	\$16.30	\$15.49	\$14.67	\$14.02	12
RG58, RG55, RG141, RG142, RG223, RG400, RG303, PE-C195, PE-P195, LMR-195			PE4081	\$13.03	\$12.38	\$11.73	\$11.21	13	
PE-SR405AL, PE-SR405FL, RG405			PE4129	\$20.13	\$19.12	\$18.12	\$17.31	14	
PE-C400, PE-B400, PE-B405, LMR-400, LMR-400-DB, LMR-400-UF, .400 inch			PE4133	\$23.12	\$22.20	\$21.50	\$21.04	15	
RG14, RG217			PE4221	\$29.75	\$28.26	\$26.78	\$25.59	16	
RG174, RG316, RG188			PE4224	\$16.98	\$16.13	\$15.28	\$14.60	17	
RG59*, RG62*, RG71			PE4331	\$18.99	\$18.04	\$17.09	\$16.33	18	
PE-C300			PE44045	\$21.28	\$20.22	\$19.15	\$18.30	19	
PE-C500, LMR-500			PE44046	\$36.35	\$34.53	\$32.72	\$31.26	20	
RG17, RG218, RG219			PE4433	\$98.86	\$93.92	\$88.97	\$85.02	21	
PE-SR401AL, PE-SR401FL, RG401			PE4434	\$20.50	\$19.48	\$18.45	\$17.63	22	
PE-C600, .600 inch, LMR-600			PE44349	\$74.07	\$70.37	\$66.66	\$63.70	23	

Connectors

See Our Website For Current Pricing & Real-Time Stock Availability!

* Fits MIL-C-17 and equivalent cable versions only

N Connectors









Connection Method	Product Image	Attachment Cable/Contact	Coax Type / Termination Type	Model No.	PRICE				ROW		
					1-24	25-49	50-99	100 +			
Male											
Cable Connectors		Clamp/Solder	PE-P300LL	PE44809	\$71.47	\$67.90	\$64.32	\$61.46	24		
			PE-P142LL	PE44825	\$44.59	\$42.36	\$40.13	\$38.25	25		
			PE-P160LL	PE45446	\$80.44	\$76.42	\$72.40	\$69.18	26		
			LMR-240, PE-C240	TC-240-NMC	\$17.25	\$17.25	\$17.25	\$17.25	27		
		Clamp/Solder (Captive Contact)	RG213, RG214, RG8, RG9, RG11*, RG225, RG393, RG144*, RG216*, RG215	PE4132	\$17.20	\$16.34	\$15.48	\$14.79	28		
			PE-SR402AL, PE-SR402FL, PE-SR402FLJ, PE-SR402TN, RG402	PE4140	\$23.66	\$22.48	\$21.29	\$20.35	29		
		Solder/Solder	PE-SR405AL, PE-SR405FL, PE-SR405FLJ, RG405	PE4222	\$38.09	\$36.19	\$34.28	\$32.76	30		
			PE-SR401AL, PE-SR401FL, RG401	PE4376	\$45.21	\$42.95	\$40.69	\$38.88	31		
			PE-SR405AL, PE-SR405FL, PE-SR405FLJ, PE-SR405TN, RG405	PE44700	\$16.70	\$15.87	\$15.03	\$14.36	32		
			PE-SR402AL, PE-SR402FL, PE-SR402FLJ, PE-SR402TN, RG402	PE44701	\$18.37	\$17.45	\$16.53	\$15.80	33		
			PE-SR402AL, PE-SR402FL, PE-SR402FLJ, PE-SR402TN, RG402	PE45002	\$34.53	\$32.80	\$31.08	\$29.70	34		
			SPP-250-LLPL	PE45427	\$24.31	\$23.09	\$21.88	\$20.91	35		
			PE-047SR, PE-SR047AL, PE-SR047FL	PE4934	\$33.64	\$31.96	\$30.28	\$28.93	36		
			SPP-250-LLPL, SPO-250, SPF-250	TC-250-NM-LP	\$11.50	\$11.50	\$11.50	\$11.50	37		
			SPP-375-LLPL	TC-SPP375-NM-LP	\$17.25	\$17.25	\$17.25	\$17.25	38		
				Clamp/Non-Solder Contact	LMR-400, PE-C400, PE-B400, PE-B405	EZ-400-NMC-2-D	\$23.00	\$23.00	\$23.00	\$23.00	39
					LMR-600, PE-C600	EZ-600-NMC-2-D	\$23.00	\$23.00	\$23.00	\$23.00	40
					LMR-SW396	EZ-SW396-NMC	\$24.28	\$24.28	\$24.28	\$24.28	41
	LMR-SW540	EZ-SW540-NMC			\$19.20	\$19.20	\$19.20	\$19.20	42		
	1/4 inch Superflexible, PE-1/4SFHC	PE44726			\$58.58	\$55.65	\$52.72	\$50.38	43		
	1/2 inch Helical, 1/2 inch Superflexible, PE-1/2 Helical, PE-1/2SFHC	PE44729			\$45.88	\$43.59	\$41.29	\$39.46	44		
	PE-1/2FAC, 1/2 inch Flexible, 1/2 inch Annular	PE44735			\$41.56	\$39.48	\$37.40	\$35.74	45		
	LMR-200, PE-C200	EZ-200-NMH-X			\$16.00	\$16.00	\$16.00	\$16.00	46		
	Crimp/Non-Solder Contact	Crimp/Non-Solder Contact	LMR-240, PE-C240, RG8X	EZ-240-NMH-X	\$12.75	\$12.75	\$12.75	\$12.75	47		
			LMR-400, PE-C400	EZ-400-NMH-PL-X	\$14.50	\$14.50	\$14.50	\$14.50	48		
			LMR-400, PE-C400, PE-B400, PE-B405	EZ-400-NMH-X	\$13.75	\$13.75	\$13.75	\$13.75	49		
			LMR-600, PE-C600	EZ-600-NMH-X	\$20.00	\$20.00	\$20.00	\$20.00	50		
			Male, Bulkhead Mount								
	Terminal		Solder	Solder Cup with .640 inch DD Hole	PE4489	\$37.39	\$35.52	\$33.65	\$32.16	51	
				Solder Cup with .350 inch D Hole	PE4490	\$42.40	\$40.28	\$38.16	\$36.46	52	
Solder Cup with .350 inch D Hole				PE4490BK	\$41.60	\$39.52	\$37.44	\$35.78	53		
Male, 4 Hole Flange Mount											
Terminal		Solder	Solder Cup with .718 inch Hole Spacing	PE4131	\$16.75	\$15.91	\$15.08	\$14.41	54		
			Pin with .718 inch Hole Spacing	PE44653	\$78.33	\$74.41	\$70.50	\$67.36	55		
			Pin with .718 inch Hole Spacing	PE4491	\$33.21	\$31.55	\$29.89	\$28.56	56		
Male Right Angle											
Cable Connectors		Crimp/Solder	PE-C195, PE-P195, RG58, RG141, RG303, LMR-195, .195 inch	PE44524	\$38.81	\$37.26	\$36.09	\$35.32	57		
			PE-C240, RG8X, .240 inch, LMR-240, LMR-240-DB, LMR-240-UF, B7808A	PE44525	\$53.52	\$50.84	\$48.17	\$46.03	58		
			PE-C400, PE-B400, PE-B405, LMR-400, LMR-400-DB, LMR-400-UF, .400 inch	PE44526	\$40.20	\$38.19	\$36.18	\$34.57	59		
			PE-C600, LMR-600, LMR-600-DB, .600 inch	PE44527	\$64.27	\$61.70	\$59.77	\$58.49	60		
			RG174, RG316, RG188, .100 inch, PE-B100, PE-C100, LMR-100	PE44675	\$33.32	\$31.65	\$29.99	\$28.66	61		
			RG213, RG8	PE4482	\$37.64	\$35.76	\$33.88	\$32.37	62		
			RG214, RG9, RG225, RG393	PE4483	\$45.60	\$43.32	\$41.04	\$39.22	63		
			RG55, RG141, RG142, RG223, RG400	PE4484	\$27.98	\$26.58	\$25.18	\$24.06	64		
			PE-C200, LMR-200	PE44844	\$50.70	\$48.17	\$45.63	\$43.60	65		
			RG58	PE4485	\$24.80	\$23.56	\$22.32	\$21.33	66		
			LMR-195, PE-C195	TC-195-NMH-RA-D	\$15.25	\$15.25	\$15.25	\$15.25	67		
		Clamp/Solder	RG58, RG55, RG141, RG142, RG223, RG400, RG303, PE-C195, PE-P195, LMR-195	PE4135	\$21.77	\$20.68	\$19.59	\$18.72	68		

* Fits MIL-C-17 and equivalent cable versions only

Connectors

See Our Website For Current Pricing & Real-Time Stock Availability!

N Connectors









Connection Method	Product Image	Attachment Cable/Contact	Coax Type / Termination Type	Model No.	PRICE		ROW
					1 Pc.	See Web for Volume Pricing	
Male Right Angle							
Cable Connectors		Clamp/Solder	RG213, RG8, RG215, RG225, RG214, RG393	PE4136	\$25.08	See Web for Volume Pricing	69
			PE-P142LL	PE44816	\$146.15		70
			PE-P300LL	PE45225	\$147.07		71
			1/2 inch Annular, 1/2 inch Flexible, PE-1/2FAC	PE45358	\$79.54		72
			PE-P160LL	PE45448	\$133.97		73
			PE-SR401AL, PE-SR401FL, RG401	PE4935	\$29.81		74
		Solder/Solder	PE-SR405AL, PE-SR405FL, PE-SR405FLJ, RG405	PE44702	\$20.97		76
			PE-SR402AL, PE-SR402FL, PE-SR402FLJ, PE-SR402TN, RG402	PE44703	\$23.07		77
			SPP-250-LLPL	PE45428	\$28.48		78
			PE-SR402AL, PE-SR402FL, RG402	PE4936	\$36.17		79
			PE-SR405AL, PE-SR405FL, PE-SR405FLJ, RG405	PE4937	\$25.70		80
			LMR-400, PE-C400, PE-B405	TC-400-NMH-RA-D	\$20.00		81
		Clamp/Non-Solder Contact	SPO-500, SPF-500	TC-SPO500-NM-RA-LP	\$13.80		82
			LMR-SW396	EZ-SW396-NMC-RA	\$26.59		83
		Crimp/Non-Solder Contact	1/2 inch Helical, 1/2 inch Superflexible, PE-1/2 Helical, PE-1/2SFHC	PE44554	\$79.13		84
			LMR-400, PE-C400, PE-B400, PE-B405	EZ-400-NMH-RA-X	\$23.00		85
		LMR-600, PE-C600	EZ-600-NMH-RA-X	\$28.75	86		
Female							
Cable Connectors		Crimp/Solder	RG55, RG141, RG142, RG223, RG400	PE4134	\$17.28	See Web for Volume Pricing	87
			RG214, RG9, RG225, RG393	PE4191	\$16.78		88
			RG213, RG8	PE4435	\$15.91		89
			RG58	PE4436	\$15.48		90
			RG174, RG316, RG188, LMR-100, PE-B100, PE-C100, .100 inch	PE4438	\$23.01		91
			PE-C195, PE-P195, RG58, RG141, RG303, LMR-195, .195 inch	PE44532	\$15.96		92
			PE-C240, RG8X, .240 inch, LMR-240, LMR-240-DB, LMR-240-UF, B7808A	PE44533	\$17.23		93
			PE-C400, PE-B400, PE-B405, LMR-400, LMR-400-DB, LMR-400-UF, .400 inch	PE44534	\$25.32		94
			PE-C600, LMR-600, LMR-600-DB, .600 inch	PE44535	\$49.92		95
			RG223, RG142, RG400, RG55	PE44789	\$20.66		96
			RG188-DS, RG316-DS	PE45172	\$20.97		97
			LMR-400, PE-C400	TC-400-NF-X	\$17.25		98
				Clamp/Solder	RG213, RG214, RG8, RG9, RG11*, RG225, RG393, RG144*, RG216*, RG215		PE4061
	RG58, RG55, RG141, RG142, RG223, RG400, RG303, PE-C195, PE-P195, LMR-195	PE4072			\$17.45		1
	PE-SR405AL, PE-SR405FL, RG405	PE4130			\$18.04		2
	PE-SR402AL, PE-SR402FL, RG402	PE4138			\$20.50		3
	RG59*, RG62*, RG71	PE4330			\$17.98		4
	PE-B400, PE-B405, PE-C400, LMR-400, .400 inch	PE4372			\$31.31		5
	PE-C600	PE44350			\$75.52		6
	RG174, RG316, RG188	PE4437			\$19.69		7
	PE-SR401AL, PE-SR401FL, RG401	PE4439			\$23.52		8
	1/2 inch Helical	PE44555			Call		9
		Clamp/Solder (Captive Contact)	1/2 inch Annular	PE44565	\$82.83		10
			PE-P300LL	PE45245	\$103.14		11
			RG14, RG217	PE4645	\$64.35		12
			RG17, RG218, RG219	PE4646	\$77.86		13
			RG213, RG214, RG8, RG9, RG11*, RG225, RG393, RG144*, RG216*, RG215	PE4059	\$30.51		14
			Solder/Solder	PE-SR405AL, PE-SR405FL, PE-SR405FLJ, RG405	PE44704	\$21.36	15
				PE-SR402AL, PE-SR402FL, PE-SR402FLJ, PE-SR402TN, RG402	PE44705	\$23.07	16
	SPP-250-LLPL	PE45426		\$24.31	17		
	PE-SR402AL, PE-SR402FL, RG402	PE4652		\$47.22	18		
	PE-SR405AL, PE-SR405FL, PE-SR405FLJ, RG405	PE4653		\$30.86	19		
	Solder/Solder	PE-047SR, PE-SR047AL, PE-SR047FL	PE4945	\$38.93	20		
		SPP-250-LLPL	TC-SPP250-NF-LP	\$11.50	21		

Connectors

See Our Website For Current Pricing & Real-Time Stock Availability!

* Fits MIL-C-17 and equivalent cable versions only

N Connectors











Connection Method	Product Image	Attachment Cable/Contact	Coax Type / Termination Type	Model No.	PRICE			ROW
					1 Pc.	See Web for Volume Pricing		
Female								
Cable Connectors		Solder/Solder	SPO-375, SPF-375	TC-SPP375-NF-LP	\$13.80			22
PCB Mount		Solder	Thru Hole with .400 inch x .062 inch Hole Spacing	PE44396	\$27.32			23
Cable Connectors		Clamp/Non-Solder Contact	1/4 inch Superflexible, PE-1/4SFHC	PE44727	\$58.68	See Web for Volume Pricing		24
			1/2 inch Helical, 1/2 inch Superflexible, PE-1/2 Helical, PE-1/2SFHC	PE44731	\$45.09			25
			PE-1/2FAC, 1/2 inch Flexible, 1/2 inch Annular	PE44737	\$43.40			26
			7/8 inch annular	PE45036	\$62.43			27
			7/8 inch Helical	PE45203	\$50.52			28
		Crimp/Non-Solder Contact	LMR-600, PE-C600	EZ-600-NF-X	\$23.00			29
Female, Bulkhead Mount								
Cable Connectors		Crimp/Crimp	RG55, RG142, RG223, RG400 with .640 inch DD Hole	PE4371	\$20.73	See Web for Volume Pricing		30
			RG58, RG141 with .640 inch DD Hole	PE4440	\$17.56			31
		Crimp/Solder	RG174, RG316, RG188, LMR-100, PE-B100, PE-C100, .100 inch with .640 inch DD Hole	PE4442	\$27.31			32
			PE-C195, PE-P195, RG58, RG141, RG303, LMR-195, .195 inch with .640 inch DD Hole	PE44528	\$24.80			33
			.240 inch, RG8X, LMR-240, B7808A, LMR-240-DB, LMR-240-UF, PE-C240 with .640 inch DD Hole	PE44529	\$18.10			34
			.400 inch, LMR-400, LMR-400-DB, LMR-400-UF, PE-B405, PE-C400, PE-B400 with .640 inch DD Hole	PE44530	\$24.09			35
			PE-C600, LMR-600 with .640 inch DD Hole	PE44531	\$46.01			36
			RG188-DS, RG316-DS	PE44877	\$29.65			37
			LMR-200, PE-C200	PE45047	\$22.60			38
			RG213, RG8 with .640 inch DD Hole	PE4940	\$30.97			39
			RG214, RG9, RG225, RG393 with .640 inch DD Hole	PE4941	\$18.78			40
			LMR-240, PE-C240	TC-240-NF-BH-X	\$22.50			41
				Clamp/Solder	PE-SR402AL, PE-SR402FL, RG402 with .640 inch DD Hole			PE4113
	RG58, RG142, RG223, RG400, RG141, RG303, RG55, LMR-400, PE-C195, PE-P195 with .640 inch DD Hole	PE4114			\$20.91			43
	RG214, RG213, RG393, RG8, RG225, RG11*, RG216*, RG144*, RG215, RG9 with .640 inch DD Hole	PE4223			\$25.80			44
	RG59*, RG62* with .640 inch DD Hole	PE4297			\$28.42			45
	RG174, RG316, RG188 with .640 inch DD Hole	PE4441			\$21.82			46
	PE-SR405AL, PE-SR405FL, RG405, PE-SR405TN with .640 inch DD Hole	PE4443			\$20.50			47
	RG178 with .640 inch DD Hole	PE44633			\$21.82			48
	PE-P300LL	PE44807			\$116.15			49
	PE-P142LL	PE44813			\$98.29			50
	RG188-DS, RG316-DS with .640 inch DD Hole	PE45173			\$19.87			51
	PE-P160LL	PE45447			\$102.71			52
	PE-SR401AL, PE-SR401FL, RG401 with .640 inch DD Hole	PE4942			\$25.03			53
	PE-B400, PE-B405, PE-C400 with .640 inch DD Hole	PE4943			\$22.56			54
		Solder/Solder			PE-SR405AL, PE-SR405FL, PE-SR405FLJ, PE-SR405TN, RG405			PE44706
			PE-SR402AL, PE-SR402FL, PE-SR402FLJ, PE-SR402TN, RG402	PE44707	\$20.96			56
			PE-SR402AL, PE-SR402FL, PE-SR402FLJ, PE-SR402TN, RG402 with .640 inch DD Hole	PE4654	\$37.85			57
			PE-SR405AL, PE-SR405FL, RG405 with .640 inch DD Hole	PE4655	\$36.47			58
PE-047SR, PE-SR047AL, PE-SR047FL with .640 inch DD Hole			PE4946	\$34.27	59			
SPP-250-LLPL			TC-SPP250-NF-BH-LP	\$11.50	60			
Terminal		Solder	Solder Cup with .640 inch DD Hole	PE4137	\$19.75			61
			Pin with .640 inch DD Hole	PE4139	\$12.72			62

* Fits MIL-C-17 and equivalent cable versions only

Connectors

See Our Website For Current Pricing & Real-Time Stock Availability!

N Connectors



Connection Method	Product Image	Attachment Cable/Contact	Coax Type / Termination Type	Model No.	PRICE				ROW
					1-24	25-49	50-99	100 +	
Female, Bulkhead Mount									
PCB Mount		Solder	Thru Hole with .640 inch DD Hole	PE44397	\$39.34	\$37.37	\$35.41	\$33.83	63
			End Launch with .630 inch Diameter	PE44615	\$31.32	\$29.75	\$28.19	\$26.94	64
Terminal		Solder Cup with .380 inch Diameter	PE4488	\$14.57	\$13.84	\$13.11	\$12.53	65	
Cable Connectors		Crimp/Non-Solder Contact	LMR-400, PE-C400, PE-B400, PE-B405	EZ-400-NF-BH	\$23.00	\$23.00	\$23.00	\$23.00	66
			LMR-600, PE-C600	EZ-600-NF-BH	\$38.00	\$38.00	\$38.00	\$38.00	67
Female, 2 Hole Flange Mount									
Terminal		Solder	Solder Cup with 1.0 inch Hole Spacing	PE44077	\$28.54	\$27.11	\$25.69	\$24.54	68
			Pin with 1.0 inch Hole Spacing	PE44079	\$48.22	\$45.81	\$43.40	\$41.47	69
Female, 4 Hole Flange Mount									
Cable Connectors		Crimp/Solder	RG213, RG8 with .718 inch Hole Spacing	PE44065	\$21.95	\$20.85	\$19.76	\$18.88	70
			RG214, RG9, RG225, RG393 with .718 inch Hole Spacing	PE44066	\$25.82	\$24.53	\$23.24	\$22.21	71
			RG55, RG141, RG142, RG223, RG400 with .718 inch Hole Spacing	PE44068	\$23.95	\$22.75	\$21.56	\$20.60	72
			.195 inch, RG58, RG141, RG303, LMR-195, LMR-195-FR, PE-C195, PE-P195 with .718 inch Hole Spacing	PE44069	\$24.17	\$22.96	\$21.75	\$20.79	73
		Clamp/Solder	RG316, RG174, LMR-100	PE45133	\$20.50	\$19.48	\$18.45	\$17.63	74
			RG58, RG142, RG223, RG400, RG141, RG303, RG55, LMR-400, PE-C195, PE-P195 with .718 inch Hole Spacing	PE4141	\$16.82	\$15.98	\$15.14	\$14.47	75
			RG174, RG316, RG188 with .718 inch Hole Spacing	PE44070	\$18.73	\$17.79	\$16.86	\$16.11	76
			PE-SR401AL, PE-SR401FL, RG401 with .718 inch Hole Spacing	PE44071	\$24.80	\$23.56	\$22.32	\$21.33	77
		Clamp/Solder (Captive Contact)	PE-SR402AL, PE-SR402FL, PE-SR402FLJ, PE-SR402TN, RG402 with .718 inch Hole Spacing	PE44072	\$25.03	\$23.78	\$22.53	\$21.53	78
			PE-SR405AL, PE-SR405FL, RG405 with .718 inch Hole Spacing	PE44073	\$24.64	\$23.41	\$22.18	\$21.19	79
			RG214, RG213, RG393, RG8, RG225, RG11*, RG216*, RG144*, RG215, RG9 with .718 inch Hole Spacing	PE4060	\$26.04	\$24.74	\$23.44	\$22.39	80
			Pin with .718 inch Hole Spacing	PE4328	\$20.47	\$19.45	\$18.42	\$17.60	81
Terminal		Solder	Pin with .340 inch Hole Spacing	PE4355	\$21.40	\$20.33	\$19.26	\$18.40	82
			Pin with .500 inch Hole Spacing	PE4444	\$23.05	\$21.90	\$20.75	\$19.82	83
			Solder Cup with .718 inch Hole Spacing	PE4487	\$58.26	\$55.35	\$52.43	\$50.10	84
			Tab with .718 inch Hole Spacing	PE4492	\$31.63	\$30.05	\$28.47	\$27.20	85
			Solder Cup	PE45085	\$18.31	\$17.39	\$16.48	\$15.75	86
			Field Replaceable	Slotted Contact	PE44721	\$32.22	\$30.61	\$29.00	\$27.71
	Slotted Contact	PE44722	\$33.15	\$31.49	\$29.84	\$28.51	88		
	Female, Press-In								
Terminal		Solder	Pin with .500 inch Diameter	PE44074	\$29.30	\$27.84	\$26.37	\$25.20	89
			Tab with .500 inch Diameter	PE44075	\$18.79	\$17.85	\$16.91	\$16.16	90
			Solder Cup with .500 inch Diameter	PE44076	\$17.71	\$16.82	\$15.94	\$15.23	91
Female Right Angle, Bulkhead Mount									
PCB Mount		Solder	Thru Hole with .596 inch D Hole	PE44398	\$26.35	\$25.03	\$23.72	\$22.66	92
Female Right Angle, 4 Hole Flange Mount									
Terminal		Solder	Solder Cup with .718 inch Hole Spacing	PE4486	\$46.56	\$44.23	\$41.90	\$40.04	93

Connectors

See Our Website For Current Pricing & Real-Time Stock Availability!

* Fits MIL-C-17 and equivalent cable versions only

Reverse Polarity N Connectors

Connection Method	Product Image	Attachment Cable/Contact	Coax Type / Termination Type	Model No.	PRICE				ROW
					1-24	25-49	50-99	100 +	
Male									
Cable Connectors		Crimp/Solder	PE-C400, PE-B400, PE-B405, LMR-400, LMR-400-DB, LMR-400-UF, .400 inch	PE44470	\$34.78	\$33.04	\$31.30	\$29.91	94
			RG213, RG8, RG215	PE44472	\$34.78	\$33.04	\$31.30	\$29.91	95
			RG214, RG393	PE44474	\$29.44	\$27.97	\$26.50	\$25.32	96
Female									
Cable Connectors		Crimp/Solder	RG55, RG141, RG142, RG223, RG400	PE44475	\$28.17	\$26.76	\$25.35	\$24.23	97
			RG58	PE44476	\$31.01	\$29.46	\$27.91	\$26.67	98
			RG214, RG9, RG225, RG393	PE44477	\$30.43	\$28.91	\$27.39	\$26.17	99
			RG213, RG8	PE44478	\$24.87	\$23.63	\$22.38	\$21.39	1

N, 7mm, SC Torque Wrenches







Type	Bit Hex Size (in.)	Preset Torque (in.-lbs.)	Model No.	1-9	10-24	25-49	50+	ROW
N, 7mm, SC	20 mm	14 in.-lbs	PE5011-7	\$318.02	\$305.30	\$295.76	\$289.40	
		8.1 in.-lbs	PE5019-5	\$224.24	\$213.03	\$201.82	\$192.85	
	3/4 inch	14 in.-lbs	PE5019-4	\$222.15	\$211.04	\$199.94	\$191.05	
	13/16 inch	14 in.-lbs	PE5019-8	\$222.15	\$211.04	\$199.94	\$191.05	

NMO Mount Connectors







Connection Method	Product Image	Attachment Cable/Contact	Coax Type / Termination Type	Model No.	PRICE				ROW
					1-24	25-49	50-99	100 +	
Sexless									
Cable Connectors		Crimp/Solder	PE-C195, PE-P195, RG58, RG55, RG141, RG142, RG223, RG400, RG303, LMR-195	PE51021	\$14.80	\$14.06	\$13.32	\$12.73	2
			RG58, LMR-195	PE51167	\$22.20	\$21.09	\$19.98	\$19.09	3

OMA Connectors

Connection Method	Product Image	Attachment Cable/Contact	Coax Type / Termination Type	Model No.	PRICE				ROW
					1-24	25-49	50-99	100 +	
Male									
Cable Connectors		Crimp/Solder	RG174, RG316, RG188, .100 inch, PE-B100, PE-C100, LMR-100	PE44501	\$24.53	\$23.30	\$22.08	\$21.10	4
			PE-C195, PE-P195, RG58, RG141, RG303, LMR-195, .195 inch	PE44503	\$20.67	\$19.64	\$18.60	\$17.78	5
			RG55, RG142, RG223, RG400	PE44514	\$19.77	\$18.78	\$17.79	\$17.00	6
		Solder/Solder	LMR-200, PE-C200	PE45224	\$11.26	\$10.70	\$10.13	\$9.68	7
			PE-SR405AL, PE-SR405FL, RG405	PE44495	\$21.64	\$20.56	\$19.48	\$18.61	8
			SPP-250-LLPL	PE45430	\$20.84	\$19.80	\$18.76	\$17.92	9
	Solder/Non-Solder Contact	PE-SR402AL, PE-SR402FL, PE-SR402FLJ, PE-SR402TN, RG402	PE44496	\$45.26	\$43.00	\$40.73	\$38.92	10	
		Male Right Angle							
Cable Connectors		Crimp/Solder	RG316-DS, RG188-DS	PE44505	\$30.89	\$29.35	\$27.80	\$26.57	11
			PE-C195, PE-P195, RG58, RG141, RG303, LMR-195, .195 inch	PE44506	\$26.34	\$25.02	\$23.71	\$22.65	12
			RG55, RG142, RG223, RG400	PE44515	\$29.62	\$28.14	\$26.66	\$25.47	13
			RG174, RG316, RG188	PE45284	\$22.05	\$20.95	\$19.85	\$18.96	14
		Solder/Solder	PE-SR405AL, PE-SR405FL, RG405	PE44497	\$24.37	\$23.15	\$21.93	\$20.96	15
			PE-SR402AL, PE-SR402FL, PE-SR402FLJ, PE-SR402TN, RG402	PE44498	\$26.63	\$25.30	\$23.97	\$22.90	16







* Fits MIL-C-17 and equivalent cable versions only

QMA Connectors

Connection Method	Product Image	Attachment Cable/Contact	Coax Type / Termination Type	Model No.	PRICE				ROW
					1-24	25-49	50-99	100 +	
Male Right Angle									
Cable Connectors		Solder/Solder	SPP-250-LLPL	PE45431	\$22.93	\$21.78	\$20.64	\$19.72	17
		Crimp/Non-Solder Contact	LMR-240, PE-C240, LMR-240-UF	EZ-240-QM-RA-X	\$19.50	\$19.50	\$19.50	\$19.50	18
Female									
Cable Connectors		Solder/Solder	SPP-250-LLPL	PE45429	\$17.38	\$16.51	\$15.64	\$14.95	19
PCB Mount		Solder	Surface Mount	PE44510	\$23.44	\$22.27	\$21.10	\$20.16	20
			Thru Hole	PE44512	\$14.84	\$14.10	\$13.36	\$12.76	21
Female, Bulkhead Mount									
Cable Connectors		Crimp/Solder	RG174, RG316, RG188, .100 inch, PE-B100, PE-C100, LMR-100 with .268 inch D Hole	PE44507	\$18.64	\$17.71	\$16.78	\$16.03	22
			RG316-DS, RG188-DS with .268 inch D Hole	PE44508	\$18.21	\$17.30	\$16.39	\$15.66	23
			RG58, RG141 with .268 inch D Hole	PE44509	\$21.64	\$20.56	\$19.48	\$18.61	24
		Solder/Solder	PE-SR402AL, PE-SR402FL, PE-SR402FLJ, PE-SR402TN, RG402 with .268 inch D Hole	PE44500	\$21.32	\$20.25	\$19.19	\$18.34	25
			PE-SR405AL, PE-SR405FL, RG405 with .268 inch D Hole	PE45218	\$28.66	\$27.23	\$25.79	\$24.65	26
Female Right Angle									
PCB Mount		Solder	Surface Mount	PE44511	\$14.38	\$13.80	\$13.37	\$13.09	27
			Thru Hole	PE44513	\$22.56	\$21.43	\$20.30	\$19.40	28

Connectors





QN Connectors

Connection Method	Product Image	Attachment Cable/Contact	Coax Type / Termination Type	Model No.	PRICE				ROW
					1-24	25-49	50-99	100 +	
Male									
Cable Connectors		Crimp/Solder	RG213, RG215	PE44597	\$69.86	\$67.07	\$64.97	\$63.57	29
			RG55, RG141, RG142, RG223, RG400	PE44978	\$30.40	\$28.88	\$27.36	\$26.14	30
			RG58, RG303, RG141, PE-C195, PE-P195, LMR-195	PE45071	\$25.47	\$24.45	\$23.69	\$23.18	31
			LMR-240, PE-C240	PE45222	\$30.19	\$28.98	\$28.08	\$27.47	32
		Solder/Solder	PE-SR402AL, PE-SR402FL, RG402	PE44599	\$36.13	\$34.32	\$32.52	\$31.07	33
Male Right Angle									
Cable Connectors		Crimp/Solder	RG55, RG141, RG142, RG223, RG400	PE44600	\$43.80	\$41.61	\$39.42	\$37.67	34
			PE-C195, PE-P195, RG58, RG141, RG303, LMR-195, .195 inch	PE44601	\$41.38	\$39.31	\$37.24	\$35.59	35
			RG214, RG225	PE44603	\$42.61	\$40.48	\$38.35	\$36.64	36
			LMR-400, PE-C400, LMR-400-DB	PE45223	\$49.40	\$46.93	\$44.46	\$42.48	37
		Solder/Solder	PE-SR402AL, PE-SR402FL, PE-SR402FLJ, PE-SR402TN, RG402	PE44604	\$41.23	\$39.17	\$37.11	\$35.46	38
Female, Bulkhead Mount									
Cable Connectors		Crimp/Solder	RG213, RG215 with .500 inch Diameter	PE44607	\$46.53	\$44.20	\$41.88	\$40.02	39
			RG214, RG225 with .500 inch Diameter	PE44608	\$93.92	\$90.16	\$87.35	\$85.47	40
		Solder/Solder	PE-SR402AL, PE-SR402FL, PE-SR402FLJ, PE-SR402TN, RG402 with .500 inch Diameter	PE44609	\$50.25	\$47.74	\$45.23	\$43.22	41
Female, 4 Hole Flange Mount									
Terminal		Solder	Solder Cup	PE44610	\$66.52	\$63.19	\$59.87	\$57.21	42







See Our Website For Current Pricing & Real-Time Stock Availability!

* Fits MIL-C-17 and equivalent cable versions only

SC Connectors

Connection Method	Product Image	Attachment Cable/Contact	Coax Type / Termination Type	Model No.	PRICE				ROW
					1 Pc.	See Web for Volume Pricing			
Male									
Cable Connectors		Crimp/Solder	RG55, RG141, RG142, RG223, RG400	PE4231	\$125.89	See Web for Volume Pricing			43
			RG214, RG9, RG225, RG393	PE4232	\$63.76				44
	Clamp/Solder	RG213, RG214, RG8, RG9, RG225, RG393, RG215	PE4520	\$176.44	45				
		RG55, RG58, RG141, RG142, RG223, RG303, RG400, PE-C195, PE-P195, LMR-195	PE45479	\$123.54	46				
Male Right Angle									
Cable Connectors		Clamp/Solder	RG58, RG55, RG141, RG142, RG223, RG400	PE4978	\$141.16				47
			RG213, RG214, RG8, RG9, RG225, RG393, RG215	PE4979	\$168.55				48
Female, Bulkhead Mount									
Terminal		Solder	Eyelet with .655 inch D Hole	PE4980	\$38.29			See Web for Volume Pricing	49
Female, 4 Hole Flange Mount									
Terminal		Solder	Solder Cup with .718 inch Hole Spacing	PE4322	\$41.36				50

SHV Connectors





Connection Method	Product Image	Attachment Cable/Contact	Coax Type / Termination Type	Model No.	PRICE				ROW
					1-24	25-49	50-99	100 +	
Plug									
Cable Connectors		Crimp/Solder	RG58, RG303, RG141, PE-C195, PE-P195, LMR-195, .195 inch	PE4194	\$45.23	\$42.97	\$40.71	\$38.90	51
			RG59*, RG62*, RG71	PE4343	\$40.41	\$38.39	\$36.37	\$34.75	52
			RG214, RG9, RG225, RG393	PE4349	\$37.65	\$35.77	\$33.89	\$32.38	53
			RG213, RG8	PE4496	\$35.34	\$33.57	\$31.81	\$30.39	54
			RG55, RG142, RG223, RG400	PE4497	\$35.67	\$33.89	\$32.10	\$30.68	55
	Clamp/Solder		RG59*, RG62*, RG71	PE4100	\$25.15	\$23.89	\$22.64	\$21.63	56
			RG58, RG55, RG141, RG142, RG223, RG400, RG303, PE-C195, PE-P195, LMR-195	PE4316	\$25.08	\$23.83	\$22.57	\$21.57	57
			RG8, RG213, RG214	PE4333	\$38.33	\$36.41	\$34.50	\$32.96	58
			RG174, RG316, RG188, LMR-100, PE-B100, PE-C100, .100 inch	PE4498	\$40.22	\$38.21	\$36.20	\$34.59	59
			Plug, Bulkhead Mount						
Terminal		Solder	Solder Cup with .350 inch D Hole	PE44118	\$49.91	\$47.41	\$44.92	\$42.92	60
Jack, Bulkhead Mount									
Cable Connectors		Clamp/Solder	RG59*, RG62*, RG71 with .480 inch D Hole	PE4315	\$48.64	\$46.21	\$43.78	\$41.83	61
			RG213, RG214, RG8, RG9, RG225, RG393, RG215 with .480 inch D Hole	PE44049	\$64.33	\$61.11	\$57.90	\$55.32	62
			RG58, RG142, RG223, RG400, RG141, RG303, RG55, LMR-400, PE-C195, PE-P195 with .480 inch D Hole	PE44080	\$48.64	\$46.21	\$43.78	\$41.83	63
Terminal		Solder	Solder Cup with .350 inch D Hole	PE4239	\$22.60	\$21.47	\$20.34	\$19.44	64
			Solder Cup with .480 inch D Hole	PE4499	\$27.24	\$25.88	\$24.52	\$23.43	65
			Solder Cup with .350 inch D Hole	PE4500	\$65.45	\$62.18	\$58.91	\$56.29	66
Jack, 4 Hole Flange Mount									
Terminal		Solder	Solder Cup with .500 inch Hole Spacing	PE4501	\$37.13	\$35.27	\$33.42	\$31.93	67

* Fits MIL-C-17 and equivalent cable versions only

Connectors

See Our Website For Current Pricing & Real-Time Stock Availability!

SMA Connectors













Connection Method	Product Image	Attachment Cable/Contact	Coax Type / Termination Type	Model No.	PRICE		ROW
					1 Pc.	See Web for Volume Pricing	
Male							
Cable Connectors		Crimp/Crimp	RG174, RG316, RG188, LMR-100, PE-B100, PE-C100, .100 inch	PE4003	\$10.77	See Web for Volume Pricing	68
		Crimp/Solder	RG55, RG142, RG223, RG400, RG141	PE4008	\$12.35		69
			RG58, RG303, RG141, PE-C195, PE-P195, LMR-195, .195 inch	PE4215	\$11.93		70
			RG59*, RG62*, RG71	PE4294	\$26.04		71
			RG178, RG196	PE4398	\$19.64		72
			RG188-DS, RG316-DS	PE4401	\$5.86		73
			PE-P195	PE44203	\$17.50		74
			PE-C195, PE-P195, RG58, RG141, RG303, LMR-195, .195 inch	PE44460	\$75.89		75
			RG142, RG223, RG400, RG55	PE44461	\$60.99		76
			PE-C240, RG8X, .240 inch, LMR-240, LMR-240-DB, LMR-240-UF, B7808A	PE44637	\$19.54		77
			PE-C400, PE-B400, PE-B405, LMR-400, LMR-400-DB, LMR-400-UF, .400 inch	PE44668	\$28.65		78
			LMR-200, PE-C200	PE45040	\$7.32		79
			RG174, RG316, RG188	PE45145	\$12.34		80
			PE-B150, RG180, RG195	PE4578	\$24.97		81
			LMR-100, PE-C100, RG174, RG188, RG316	TC-100-SM	\$12.25		82
	LMR-195, PE-C195	TC-195-SM-SS-X	\$15.25	83			
	LMR-200, PE-C200	TC-200-SM-SS-X	\$14.00	84			
	LMR-240, PE-C240, LMR-240-UF	TC-240-SM-SS-X	\$10.00	85			
	LMR-400, PE-C400	TC-400-SM-X	\$13.75	86			
	Cable Connectors		Crimp/Solder (Captive Contact)	RG55, RG141, RG142, RG223, RG400	PE4576		\$28.88
RG58				PE4577	\$24.24	88	
RG174, RG316, RG188, LMR-100, PE-B100, PE-C100, .100 inch				PE4589	\$18.55	89	
PCB Mount		Clamp	Vertical Launch	PE45460	\$37.61	90	
			Vertical Launch	PE45461	\$39.08	91	
Cable Connectors		Clamp/Solder	RG174, RG316, RG188, PE-B100, PE-C100, .100 inch, LMR-100	PE4026	\$29.24	See Web for Volume Pricing	92
			RG55, RG58, RG141, RG142, RG223, RG303, RG400, PE-C195, PE-P195, LMR-195	PE4027	\$28.19		93
			RG178, RG196	PE4214	\$53.36		94
			RG213, RG214, RG8, RG9, RG11*, RG225, RG393, RG144*, RG216*, RG215	PE4332	\$83.77		95
			RG180, RG195, PE-B150	PE4399	\$23.31		96
			RG188-DS, RG316-DS	PE4400	\$30.89		97
			PE-SR401AL, PE-SR401FL, RG401	PE4403	\$42.34		98
			PE-P300LL	PE44808	\$60.91		99
			PE-P142LL	PE44826	\$38.86		1
			PE-P300LL	PE45042	\$65.13		2
	RG58, RG303, LMR-195, PE-P195	PE45140	\$22.73	3			
	RG316, RG174, LMR-100	PE45142	\$14.46	4			
	PE-P160LL	PE45440	\$77.42	5			
	PE-SR405AL, PE-SR405FL, RG405	PE4005	\$7.72	6			
	RG174, RG316, RG188, LMR-100, PE-B100, PE-C100, .100 inch	PE4036	\$13.75	7			
	RG58, RG55, RG142, RG223, RG400	PE4037	\$15.44	8			
	PE-SR402AL, PE-SR402FL, PE-SR402FLJ, PE-SR402TN, RG402	PE4112	\$10.42	9			
	RG178, RG196	PE4213	\$18.30	10			
	RG188-DS, RG316-DS	PE4402	\$16.74	11			
	PE-047SR, PE-SR047AL, PE-SR047FL	PE4404	\$27.52	12			
PE-SR405AL, PE-SR405FL, PE-SR405FLJ, PE-SR405TN, RG405	PE44690	\$9.90	13				
PE-047SR, PE-SR047AL, PE-SR047FL	PE44757	\$34.91	14				
RG405, PE-SR405FL, PE-SR405FLJ	PE45135	\$9.06	15				
SPP-250-LLPL	PE45543	\$13.89	16				
PE-SR401AL, PE-SR401FL, RG401	PE4907	\$44.07	17				
PE-034SR	PE4917	\$81.80	18				
PE-020SR	PE4918	\$45.63	19				

Connectors

See Our Website For Current Pricing & Real-Time Stock Availability!

* Fits MIL-C-17 and equivalent cable versions only

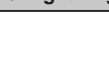
SMA Connectors









Connection Method	Product Image	Attachment Cable/Contact	Coax Type / Termination Type	Model No.	PRICE			ROW
					1 Pc.	See Web for Volume Pricing		
Male								
Cable Connectors		Solder/Solder	SPP-250-LLPL	TC-SPP250-SM-LP	\$6.90	See Web for Volume Pricing		20
		Solder (Without Contact)	PE-SR402AL, PE-SR402FL, PE-SR402FLJ, PE-SR402TN, RG402	PE4007	\$10.23			21
		Solder/Solder (Captive Contact)	RG58, RG55, RG142, RG223, RG400	PE4587	\$21.53			22
			RG174, RG316, RG188	PE4590	\$17.30			23
PCB Mount		Solder	PE-SR402AL, PE-SR402FL, PE-SR402FLJ, PE-SR402TN, RG402	PE44691	\$10.15			25
			RG405, RG405 Tinned	PE45480	\$38.66			27
			RG405, RG405 Tinned	PE45481	\$38.66			28
			.042 inch End Launch	PE44210	\$33.80			24
			Thru Hole with .200 inch x .067 inch Hole Spacing	PE4525	\$23.33			26
			.062 inch End Launch	PE4912	\$32.00			29
Cable Connectors		Crimp/Non-Solder Contact	LMR-240, PE-C240	EZ-240-SM-X	\$9.65	31		
Male, Bulkhead Mount								
Terminal		Solder	Solder Cup with .235 inch D Hole	PE4354	\$20.23			32
			Stub with .250 inch Diameter	PE4531	\$40.03			33
			Solder Cup with .350 inch D Hole	PE4544	\$19.03			34
Male, 2 Hole Flange Mount								
Terminal		Solder	Solder Cup with .481 inch Hole Spacing	PE4125	\$29.82	See Web for Volume Pricing		35
			Stub with .481 inch Hole Spacing	PE4127	\$14.41			36
			Solder Cup	PE45139	\$10.02			37
Field Replaceable		Field Replaceable	.036 inch Pin	PE44032	\$18.69			38
Male, 4 Hole Flange Mount								
Terminal		Solder	Stub with .340 inch Hole Spacing	PE4126	\$24.89			39
			Solder Cup with .340 inch Hole Spacing	PE45204	\$51.75			40
			Pin with .340 inch Hole Spacing	PE4541	\$54.89			41
Field Replaceable		Field Replaceable	.012 inch Pin	PE44005	\$37.73	42		
			.018 inch Pin	PE44007	\$22.98	43		
			.020 inch Pin	PE44008	\$39.20	44		
			.036 inch Pin	PE44009	\$23.43	45		
			.012 inch Pin	PE44018	\$27.34	46		
			.015 inch Pin	PE44019	\$45.31	47		
			.018 inch Pin	PE44020	\$37.73	48		
			.020 inch Pin	PE44021	\$23.88	49		
Male Right Angle								
Cable Connectors		Crimp/Solder	RG55, RG142, RG223, RG400, RG141	PE4002	\$18.51	See Web for Volume Pricing		50
			RG174, RG316, RG188, LMR-100, PE-B100, PE-C100, .100 inch	PE4009	\$21.47			51
			RG178, RG196	PE4296	\$28.39			52
			RG59*, RG62*, RG71	PE4327	\$35.14			53
			RG58, RG303, RG141, PE-C195, PE-P195, LMR-195, .195 inch	PE4405	\$11.67			54
			RG188-DS, RG316-DS	PE4408	\$19.17			55
			PE-C240, RG8X, .240 inch, LMR-240, LMR-240-DB, LMR-240-UF, B7808A	PE44638	\$28.42			56
	PE-B150, RG180, RG195	PE4580	\$24.11	57				
		Clamp/Solder	RG174, RG316, RG188, .100 inch, PE-B100, PE-C100, LMR-100	PE4028	\$34.13			58
			RG178, RG196	PE4108	\$20.84			59
			RG188-DS, RG316-DS	PE4407	\$43.47			60
			PE-P142LL	PE44817	\$123.42			61
			PE-SR402AL, PE-SR402FL, PE-SR402FLJ, PE-SR402TN, RG402	PE44996	\$96.08			62
			PE-P300LL	PE45041	\$126.54			63

* Fits MIL-C-17 and equivalent cable versions only

Connectors

See Our Website For Current Pricing & Real-Time Stock Availability!

SMA Connectors









Connection Method	Product Image	Attachment Cable/Contact	Coax Type / Termination Type	Model No.	PRICE		ROW
					1 Pc.	See Web for Volume Pricing	
Male Right Angle							
Cable Connectors		Clamp/Solder	RG58, RG55, RG141, RG142, RG223, RG303, RG400, LMR-195, PE-C195	PE45048	\$50.08	See Web for Volume Pricing	64
			PE-P160LL	PE45442	\$113.13		65
			RG180, RG195	PE4579	\$25.43		66
		Solder/Solder	PE-SR405AL, PE-SR405FL, RG405	PE4025	\$30.18		67
			RG316, RG174, RG188, LMR-100, PE-B100, PE-C100, .100 inch	PE4038	\$19.97		68
			RG58, RG55, RG142, RG223, RG400	PE4039	\$18.47		69
			PE-SR402AL, PE-SR402FL, PE-SR402FLJ, PE-SR402TN, RG402	PE4083	\$21.64		70
			RG178, RG196	PE4406	\$24.64		71
			RG188-DS, RG316-DS	PE4409	\$22.87		72
			PE-SR405AL, PE-SR405FL, PE-SR405FLJ, PE-SR405TN, RG405	PE44692	\$12.02		73
			PE-SR402AL, PE-SR402FL, PE-SR402FLJ, PE-SR402TN, RG402	PE44693	\$11.60		74
			PE-047SR, PE-SR047AL, PE-SR047FL	PE45282	\$60.56		75
			SPP-250-LLPL	PE45434	\$15.29		76
			PE-034SR	PE4919	\$59.91		77
			PE-020SR	PE4920	\$66.44		78
PE-SR401AL, PE-SR401FL, RG401	PE4932	\$60.86	79				
		SPP-250-LLPL	TC-SPP250-SM-RA-LP	\$11.50	80		
PCB Mount		Solder	Thru Hole with .200 inch x .067 inch Hole Spacing	PE4526	\$45.13	81	
Cable Connectors		Crimp/Non-Solder Contact	LMR-240	EZ-240-SM-RA-X	\$12.75	82	
Female							
Cable Connectors		Crimp/Solder	RG178, RG196	PE4325	\$28.72	See Web for Volume Pricing	83
			RG59*, RG62*	PE4326	\$28.28		84
			RG55, RG142, RG223	PE4412	\$17.55		85
			RG58, RG303, RG141, PE-C195, PE-P195, LMR-195	PE4413	\$17.90		86
			RG174, RG316, RG188, .100 inch, PE-B100, PE-C100, LMR-100	PE4414	\$19.86		87
			RG188-DS, RG316-DS	PE4416	\$19.69		88
			PE-C240, RG8X, .240 inch, LMR-240, LMR-240-DB, LMR-240-UF, B7808A	PE44639	\$24.01		89
			PE-C400, PE-B400, PE-B405, LMR-400, LMR-400-DB, LMR-400-UF, .400 inch	PE44669	\$47.64		90
PCB Mount		Clamp	Vertical Launch	PE45137	\$9.13	91	
			Vertical Launch	PE45458	\$36.52	92	
Cable Connectors		Clamp/Solder	RG316, RG174, RG188, PE-B100, PE-C100, .100 inch, LMR-100	PE4030	\$33.30	See Web for Volume Pricing	94
			RG55, RG58, RG141, RG142, RG223, RG303, RG400, PE-C195, PE-P195, LMR-195	PE4031	\$44.47		95
			RG213, RG214, RG8, RG9, RG11*, RG225, RG393	PE4411	\$62.79		96
			RG188-DS, RG316-DS	PE4415	\$32.87		97
			PE-P142LL	PE44814	\$68.57		98
PCB Mount		Clamp/Solder (Captive Contact)	End Launch	PE4591	\$29.29	See Web for Volume Pricing	99
			End Launch	PE45462	\$52.01		1
			End Launch	PE45463	\$52.01		2
			End Launch	PE45464	\$52.01		3
			End Launch	PE45465	\$52.01		4
Cable Connectors		Solder/Solder	RG316, RG174, RG188	PE45466	\$50.06	See Web for Volume Pricing	5
			RG58, RG55, RG142, RG223, RG400	PE4040	\$15.64		6
			PE-SR402AL, PE-SR402FL, PE-SR402FLJ, PE-SR402TN, RG402	PE4041	\$17.20		7
			PE-SR405AL, PE-SR405FL, PE-SR405FLJ, RG405	PE4115	\$17.63		8
			RG188-DS, RG316-DS	PE4116	\$22.88		9
			RG178, RG196	PE4417	\$14.98		10
PE-047SR, PE-SR047AL, PE-SR047FL	PE4418	\$38.96	11				
PE-SR405AL, PE-SR405FL, PE-SR405FLJ, PE-SR405TN, RG405	PE44694	\$8.52	12				

Connectors

See Our Website For Current Pricing & Real-Time Stock Availability!

* Fits MIL-C-17 and equivalent cable versions only

SMA Connectors











Connection Method	Product Image	Attachment Cable/Contact	Coax Type / Termination Type	Model No.	PRICE				ROW		
					1-24	25-49	50-99	100 +			
Female											
Cable Connectors		Solder/Solder	PE-SR402AL, PE-SR402FL, PE-SR402FLJ, PE-SR402TN, RG402	PE44695	\$9.55	\$9.07	\$8.60	\$8.21	13		
			SPP-250-LLPL	PE45432	\$14.59	\$13.86	\$13.13	\$12.55	14		
			RG178, RG196	PE4592	\$25.71	\$24.42	\$23.14	\$22.11	15		
			PE-034SR	PE4921	\$59.91	\$56.91	\$53.92	\$51.52	16		
			PE-020SR	PE4922	\$65.26	\$62.00	\$58.73	\$56.12	17		
			PE-SR401AL, PE-SR401FL, RG401	PE4930	\$29.92	\$28.42	\$26.93	\$25.73	18		
PCB Mount		Solder/Solder (Captive Contact)	1/8 inch Stripline	PE4190	\$46.56	\$44.23	\$41.90	\$40.04	19		
			1/16 inch Stripline	PE4534	\$44.25	\$42.04	\$39.83	\$38.06	20		
		Solder	Thru Hole with .200 inch x .067 inch Hole Spacing	PE4117	\$14.39	\$13.67	\$12.95	\$12.38	21		
			.042 inch End Launch	PE44204	\$25.42	\$24.15	\$22.88	\$21.86	22		
			.047 inch End Launch	PE44205	\$29.06	\$27.61	\$26.15	\$24.99	23		
			.031 inch End Launch	PE44206	\$20.52	\$19.49	\$18.47	\$17.65	24		
			.042 inch End Launch	PE44207	\$27.13	\$25.77	\$24.42	\$23.33	25		
			.047 inch End Launch	PE44208	\$28.24	\$26.83	\$25.42	\$24.29	26		
			End Launch	PE44235	\$22.93	\$21.78	\$20.64	\$19.72	27		
			.078 inch End Launch	PE44614	\$34.64	\$32.91	\$31.18	\$29.79	28		
			Thru Hole with .200 inch x .067 inch Hole Spacing	PE44827	\$10.85	\$10.31	\$9.77	\$9.33	29		
			.062 inch End Launch	PE4542	\$18.73	\$17.79	\$16.86	\$16.11	30		
			.062 inch End Launch	PE4543	\$20.03	\$19.03	\$18.03	\$17.23	31		
			Surface Mount	PE4910	\$17.00	\$16.15	\$15.30	\$14.62	32		
Female, Bulkhead Mount											
Cable Connectors		Crimp/Solder	RG55, RG142, RG223, RG141 with .235 inch D Hole	PE4419	\$21.64	\$20.56	\$19.48	\$18.61	33		
			RG58 with .235 inch D Hole	PE4420	\$19.17	\$18.21	\$17.25	\$16.49	34		
			RG178, RG196 with .235 inch D Hole	PE4422	\$24.70	\$23.47	\$22.23	\$21.24	35		
			RG188-DS, RG316-DS with .235 inch D Hole	PE4425	\$22.35	\$21.23	\$20.12	\$19.22	36		
			RG316, RG174, RG188, PE-B100, PE-C100, .100 inch, LMR-100 with .235 inch D Hole	PE4427	\$15.89	\$15.10	\$14.30	\$13.67	37		
			RG174, RG316, RG188, .100 inch, PE-B100, PE-C100, LMR-100 with .235 inch D Hole	PE44643	\$22.52	\$21.39	\$20.27	\$19.37	38		
			RG316, RG174, LMR-100	PE45136	\$15.55	\$14.77	\$14.00	\$13.37	39		
			RG58, RG303, LMR-195	PE45138	\$11.08	\$10.53	\$9.97	\$9.53	40		
			RG58, RG303, LMR-195, PE-P195	PE45141	\$12.48	\$11.86	\$11.23	\$10.73	41		
			RG178, RG196 with .235 inch D Hole	PE45292	\$19.75	\$18.76	\$17.78	\$16.99	42		
		Clamp/Solder	RG59*, RG62*, RG71 with .235 inch D Hole	PE4914	\$26.17	\$24.86	\$23.55	\$22.51	43		
			RG316, RG174, RG188, PE-B100, PE-C100, .100 inch, LMR-100 with .235 inch D Hole	PE4032	\$34.07	\$32.37	\$30.66	\$29.30	44		
			RG58, RG142, RG223, RG400, RG141, RG303, RG55, LMR-400, PE-C195, PE-P195 with .235 inch D Hole	PE4033	\$39.62	\$37.64	\$35.66	\$34.07	45		
			RG178, RG196 with .235 inch D Hole	PE4421	\$38.53	\$36.60	\$34.68	\$33.14	46		
			RG188-DS, RG316-DS with .235 inch D Hole	PE4424	\$41.17	\$39.11	\$37.05	\$35.41	47		
			PE-P160LL	PE45441	\$93.78	\$89.09	\$84.40	\$80.65	48		
				Solder/Solder	PE-SR405AL, PE-SR405FL, RG405 with .235 inch D Hole	PE4119	\$15.14	\$14.38	\$13.63	\$13.02	49
					RG316, RG174, RG188 with .235 inch D Hole	PE4188	\$17.81	\$16.92	\$16.03	\$15.32	50
					RG58, RG55, RG142, RG223 with .235 inch D Hole	PE4353	\$19.29	\$18.33	\$17.36	\$16.59	51
					RG178, RG196 with .235 inch D Hole	PE4423	\$24.31	\$23.09	\$21.88	\$20.91	52
RG188-DS, RG316-DS with .235 inch D Hole	PE4426	\$20.50			\$19.48	\$18.45	\$17.63	53			
PE-SR405AL, PE-SR405FL, PE-SR405FLJ, PE-SR405TN, RG405	PE44696	\$12.36			\$11.74	\$11.12	\$10.63	54			
PE-SR402AL, PE-SR402FL, PE-SR402FLJ, PE-SR402TN, RG402	PE44697	\$11.10			\$10.55	\$9.99	\$9.55	55			
PE-SR402AL, PE-SR402FL, PE-SR402FLJ, PE-SR402TN, RG402 with .235 inch D Hole	PE45554	\$16.59			\$15.76	\$14.93	\$14.27	56			
Terminal		Solder	Solder Cup with .235 inch D Hole	PE4101	\$17.64	\$16.76	\$15.88	\$15.17	60		
			Stub with .250 inch Diameter	PE4189	\$16.50	\$15.68	\$14.85	\$14.19	61		
			Solder Cup with .235 inch D Hole	PE4219	\$14.88	\$14.14	\$13.39	\$12.80	62		
			PCB Mount		Solder	.042 inch End Launch with .250 inch Diameter	PE44211	\$27.56	\$26.18	\$24.80	\$23.70
.062 inch End Launch with .250 inch Diameter	PE44212	\$25.05				\$23.80	\$22.55	\$21.54	64		
.042 inch End Launch with .250 inch Diameter	PE44213	\$25.11				\$23.85	\$22.60	\$21.59	65		
.062 inch End Launch with .250 inch Diameter	PE44214	\$26.56				\$25.23	\$23.90	\$22.84	66		

* Fits MIL-C-17 and equivalent cable versions only

Connectors

See Our Website For Current Pricing & Real-Time Stock Availability!

SMA Connectors







Connection Method	Product Image	Attachment Cable/Contact	Coax Type / Termination Type	Model No.	PRICE				ROW
					1-24	25-49	50-99	100 +	
Female, Bulkhead Mount									
Terminal		Solder	Stub with .250 inch Diameter	PE44591	\$30.04	\$28.54	\$27.04	\$25.83	67
PCB Mount			End Launch	PE45134	\$24.16	\$22.95	\$21.74	\$20.78	68
			Thru Hole with .235 inch D Hole	PE4524	\$19.43	\$18.46	\$17.49	\$16.71	69
Terminal			Stub with .235 inch D Hole	PE4528	\$40.51	\$38.48	\$36.46	\$34.84	70
			Solder Cup with .235 inch D Hole	PE4529	\$49.66	\$47.18	\$44.69	\$42.71	71
			Stub with .250 inch Diameter	PE4530	\$34.93	\$33.18	\$31.44	\$30.04	72
			Stub with .250 inch Diameter	PE4532	\$28.55	\$27.12	\$25.70	\$24.55	73
			Solder Cup with .350 inch D Hole	PE4536	\$42.59	\$40.46	\$38.33	\$36.63	74
			Solder Cup with .250 inch Diameter	PE4549	\$29.56	\$28.08	\$26.60	\$25.42	75
Female, 2 Hole Flange Mount									
Cable Connectors		Solder/Solder	PE-SR402AL, PE-SR402FL, RG402 with .481 inch Hole Spacing	PE4196	\$26.46	\$25.14	\$23.81	\$22.76	76
			PE-SR405AL, PE-SR405FL, PE-SR405FLJ, RG405 with .481 inch Hole Spacing	PE4197	\$24.22	\$23.01	\$21.80	\$20.83	77
			PE-047SR, PE-SR047AL, PE-SR047FL with .481 inch Hole Spacing	PE4547	\$27.53	\$26.15	\$24.78	\$23.68	78
Terminal		Solder	Solder Cup with .481 inch Hole Spacing	PE4004	\$16.98	\$16.13	\$15.28	\$14.60	79
			Stub with .481 inch Hole Spacing	PE4128	\$19.67	\$18.69	\$17.70	\$16.92	80
			Stub with .481 inch Hole Spacing	PE4128-SF	\$17.94	\$17.04	\$16.15	\$15.43	81
			Tab with .481 inch Hole Spacing	PE4370	\$24.62	\$23.39	\$22.16	\$21.17	82
			Solder Cup with .481 inch Hole Spacing	PE44341	\$60.41	\$57.39	\$54.37	\$51.95	83
			Stub	PE45039	\$16.36	\$15.71	\$15.21	\$14.89	84
			Stub	PE45067	\$16.11	\$15.30	\$14.50	\$13.85	85
Field Replaceable		Field Replaceable	.015 inch Pin	PE44024	\$33.23	\$31.57	\$29.91	\$28.58	86
			.018 inch Pin	PE44025	\$36.74	\$34.90	\$33.07	\$31.60	87
			.036 inch Pin	PE45055	\$29.09	\$27.64	\$26.18	\$25.02	88
			.012 inch Pin	PE45217	\$29.67	\$28.19	\$26.70	\$25.52	89
Terminal		Compression	Stub with .481 inch Hole Spacing	PE44340	\$63.25	\$60.09	\$56.93	\$54.40	90
Female, 4 Hole Flange Mount									
Cable Connectors		Clamp/Solder	.100 inch, RG316, RG174, RG188, LMR-100, LMR-100A, LMR-100A-FR, PE-C100, PE-B100 with .340 inch Hole Spacing	PE4034	\$58.67	\$55.74	\$52.80	\$50.46	91
		Solder/Solder	RG402, RG402 Tinned, PE-SR402FL, PE-SR402AL, PE-SR402FLJ, PE-SR402TN with .340 inch Hole Spacing	PE4121	\$37.48	\$35.61	\$33.73	\$32.23	92
	RG405, RG405 Tinned, PE-SR405FL, PE-SR405AL, PE-SR405FLJ, PE-SR405TN		PE44998	\$31.29	\$29.73	\$28.16	\$26.91	93	
	PE-047SR, PE-SR047AL, PE-SR047FL with .340 inch Hole Spacing	PE4548	\$43.44	\$41.27	\$39.10	\$37.36	94		
Terminal		Solder	Solder Cup with .340 inch Hole Spacing	PE4000	\$22.39	\$21.27	\$20.15	\$19.26	95
			Stub with .340 inch Hole Spacing	PE4099	\$19.54	\$18.56	\$17.59	\$16.80	96
			Tab with .340 inch Hole Spacing	PE4186	\$20.98	\$19.93	\$18.88	\$18.04	97
			Pin with .340 inch Hole Spacing	PE4217	\$25.42	\$24.15	\$22.88	\$21.86	98
			Solder Cup with .718 inch Hole Spacing	PE4218	\$28.38	\$26.96	\$25.54	\$24.41	99
			Solder Cup with .500 inch Hole Spacing	PE4527	\$27.56	\$26.18	\$24.80	\$23.70	1
			Stub with .500 inch Hole Spacing	PE4533	\$26.06	\$24.76	\$23.45	\$22.41	2
			Solder Cup with .340 inch Hole Spacing	PE4537	\$32.20	\$30.59	\$28.98	\$27.69	3
			Pin with .375 inch x .500 inch Hole Spacing	PE4538	\$41.99	\$39.89	\$37.79	\$36.11	4
			Tab with .375 inch x .500 inch Hole Spacing	PE4539	\$32.20	\$30.59	\$28.98	\$27.69	5
Pin with .340 inch Hole Spacing	PE4540	\$50.62	\$48.09	\$45.56	\$43.53	6			
Field Replaceable		Field Replaceable	.012 inch Pin	PE44000	\$38.28	\$36.37	\$34.45	\$32.92	7
			.015 inch Pin	PE44001	\$35.44	\$33.67	\$31.90	\$30.48	8
			.020 inch Pin	PE44003	\$35.80	\$34.01	\$32.22	\$30.79	9
			.036 inch Pin	PE44004	\$38.28	\$36.37	\$34.45	\$32.92	10
			.012 inch Pin	PE44010	\$36.57	\$34.74	\$32.91	\$31.45	11
			.036 inch Pin	PE45053	\$31.86	\$30.27	\$28.67	\$27.40	12
			.020 inch Pin	PE45215	\$19.72	\$18.73	\$17.75	\$16.96	13
			.015 inch Pin	PE45216	\$22.10	\$21.00	\$19.89	\$19.01	14

Connectors





See Our Website For Current Pricing & Real-Time Stock Availability!

* Fits MIL-C-17 and equivalent cable versions only

SMA Connectors





Connection Method	Product Image	Attachment Cable/Contact	Coax Type / Termination Type	Model No.	PRICE				ROW
					1-24	25-49	50-99	100 +	
Female, Press-In									
Terminal		Solder	Tab with .200 inch Diameter	PE44240	\$28.77	\$27.33	\$25.89	\$24.74	15
			Tab with .200 inch Diameter	PE44241	\$31.80	\$30.21	\$28.62	\$27.35	16
Female Right Angle									
PCB Mount		Solder	Thru Hole with .200 inch x .067 inch Hole Spacing	PE4118	\$20.90	\$19.86	\$18.81	\$17.97	17
			Surface Mount	PE4911	\$28.28	\$26.87	\$25.45	\$24.32	18
Female Right Angle, Bulkhead Mount									
Terminal		Solder	Solder Cup with .235 inch D Hole	PE4300	\$53.70	\$51.02	\$48.33	\$46.18	19
PCB Mount			Thru Hole with .235 inch D Hole	PE4545	\$28.86	\$27.42	\$25.97	\$24.82	20
Female Right Angle, 2 Hole Flange Mount									
Terminal		Solder	Pin with .481 inch Hole Spacing	PE44237	\$54.06	\$51.36	\$48.65	\$46.49	21
			Pin with .481 inch Hole Spacing	PE44238	\$50.77	\$48.23	\$45.69	\$43.66	22
			Pin with .481 inch Hole Spacing	PE44239	\$51.92	\$49.32	\$46.73	\$44.65	23
			Pin with .481 inch Hole Spacing	PE44593	\$50.77	\$48.23	\$45.69	\$43.66	24
Female Right Angle, 4 Hole Flange Mount									
Terminal		Solder	Solder Cup with .340 inch Hole Spacing	PE4123	\$38.33	\$36.41	\$34.50	\$32.96	25
			Pin with .340 inch Hole Spacing	PE44236	\$34.04	\$32.34	\$30.64	\$29.27	26
Field Replaceable		Field Replaceable	.012 inch Pin	PE44015	\$57.89	\$55.00	\$52.10	\$49.79	27

Reverse Polarity SMA Connectors

Connection Method	Product Image	Attachment Cable/Contact	Coax Type / Termination Type	Model No.	PRICE				ROW
					1-24	25-49	50-99	100 +	
Male									
Cable Connectors		Crimp/Solder	PE-C240, RG8X, .240 inch, LMR-240, LMR-240-DB, LMR-240-UF, B7808A	PE44664	\$24.89	\$23.65	\$22.40	\$21.41	28
			PE-C400, PE-B400, PE-B405, LMR-400, LMR-400-DB, LMR-400-UF, .400 inch	PE44666	\$29.67	\$28.19	\$26.70	\$25.52	29
			RG188-DS, RG316-DS	PE45183	\$18.47	\$17.55	\$16.62	\$15.88	30
			RG55, RG141, RG142, RG223, RG400	PE4767	\$21.78	\$20.69	\$19.60	\$18.73	31
			RG58	PE4769	\$21.87	\$20.78	\$19.68	\$18.81	32
			RG174, RG316, RG188, PE-B100, PE-C100, .100 inch, LMR-100	PE4771	\$20.30	\$19.29	\$18.27	\$17.46	33
			PE-B150, RG180, RG195	PE4777	\$14.83	\$14.09	\$13.35	\$12.75	34
		Clamp/Solder	RG55, RG58, RG141, RG142, RG223, RG303, RG400, PE-C195, PE-P195, LMR-195	PE4766	\$33.75	\$32.06	\$30.38	\$29.03	35
			RG174, RG316, RG188, PE-B100, PE-C100, .100 inch, LMR-100	PE4770	\$37.61	\$35.73	\$33.85	\$32.34	36
			RG178, RG196	PE4773	\$12.93	\$12.28	\$11.64	\$11.12	37
		Solder/Solder	PE-SR402AL, PE-SR402FL, PE-SR402FLJ, PE-SR402TN, RG402	PE44724	\$20.72	\$19.68	\$18.65	\$17.82	38
			RG58, RG55, RG141, RG142, RG223, RG400	PE4768	\$21.82	\$20.73	\$19.64	\$18.77	39
			RG174, RG316, RG188	PE4772	\$20.20	\$19.19	\$18.18	\$17.37	40
			RG178, RG196	PE4775	\$25.80	\$24.77	\$23.99	\$23.48	41
			PE-SR405AL, PE-SR405FL, RG405	PE4779	\$26.34	\$25.02	\$23.71	\$22.65	42
Male Right Angle									
Cable Connectors		Crimp/Solder	RG58, RG141, PE-C195, PE-P195	PE45012	\$34.11	\$32.40	\$30.70	\$29.33	43
			RG188-DS, RG316-DS	PE45185	\$42.95	\$40.80	\$38.66	\$36.94	44
			RG174, RG316, RG188, PE-B100, PE-C100, .100 inch, LMR-100	PE4785	\$54.93	\$52.18	\$49.44	\$47.24	45
			RG178, RG196	PE4788	\$37.73	\$35.84	\$33.96	\$32.45	46
			RG55, RG142, RG223, RG400	PE44975	\$39.57	\$37.59	\$35.61	\$34.03	47

* Fits MIL-C-17 and equivalent cable versions only

Reverse Polarity SMA Connectors



Connection Method	Product Image	Attachment Cable/Contact	Coax Type / Termination Type	Model No.	PRICE				ROW
					1-24	25-49	50-99	100 +	
Male Right Angle									
Cable Connectors		Clamp/Solder	RG58, RG55, RG141, RG142, RG223, RG400	PE4780	\$40.75	\$38.71	\$36.68	\$35.05	48
			RG174, RG316, RG188	PE4784	\$56.45	\$53.63	\$50.81	\$48.55	49
			RG178, RG196	PE4787	\$77.56	\$74.46	\$72.13	\$70.58	50
		Solder/Solder	RG58, RG55, RG141, RG142, RG223, RG400	PE4782	\$37.97	\$36.07	\$34.17	\$32.65	51
			RG174, RG316, RG188	PE4786	\$37.97	\$36.07	\$34.17	\$32.65	52
			PE-SR402AL, PE-SR402FL, RG402	PE4790	\$45.31	\$43.04	\$40.78	\$38.97	53
PE-SR405AL, PE-SR405FL, PE-SR405FLJ, PE-SR405TN, RG405			PE4791	\$47.79	\$45.40	\$43.01	\$41.10	54	
Female									
Cable Connectors		Crimp/Solder	PE-C240, RG8X, .240 inch, LMR-240, LMR-240-DB, LMR-240-UF, B7808A	PE44665	\$26.77	\$25.43	\$24.09	\$23.02	55
			RG188-DS, RG316-DS	PE45186	\$28.08	\$26.68	\$25.27	\$24.15	56
			RG55, RG141, RG142, RG223, RG400	PE4793	\$33.47	\$31.80	\$30.12	\$28.78	57
			RG58	PE4795	\$26.86	\$25.52	\$24.17	\$23.10	58
			RG174, RG316, RG188, PE-B100, PE-C100, .100 inch, LMR-100, RG179	PE4797	\$31.08	\$29.53	\$27.97	\$26.73	59
			RG178, RG196	PE4799	\$30.42	\$28.90	\$27.38	\$26.16	60
		Clamp/Solder	RG55, RG58, RG141, RG142, RG223, RG303, RG400, PE-C195, PE-P195, LMR-195	PE4792	\$32.59	\$30.96	\$29.33	\$28.03	61
			RG178, RG196	PE4850	\$12.25	\$11.76	\$11.39	\$11.15	62
		Solder/Solder	PE-SR402AL, PE-SR402FL, PE-SR402FLJ, PE-SR402TN, RG402	PE44723	\$26.18	\$24.87	\$23.56	\$22.51	63
			RG58, RG55, RG141, RG142, RG223, RG400	PE4794	\$24.38	\$23.16	\$21.94	\$20.97	64
			RG174, RG316, RG188	PE4798	\$26.86	\$25.52	\$24.17	\$23.10	65
			RG178, RG196	PE4851	\$23.24	\$22.08	\$20.92	\$19.99	66
PE-SR402AL, PE-SR402FL, RG402			PE4852	\$30.99	\$29.44	\$27.89	\$26.65	67	
PE-SR405AL, PE-SR405FL, PE-SR405FLJ, PE-SR405TN, RG405			PE4853	\$17.05	\$16.20	\$15.35	\$14.66	68	
PCB Mount		Solder	Thru Hole with .200 inch x .067 inch Hole Spacing	PE4869	\$24.61	\$23.38	\$22.15	\$21.16	69
			.062 inch End Launch	PE4874	\$28.31	\$26.89	\$25.48	\$24.35	70
Female, Bulkhead Mount									
Cable Connectors		Crimp/Solder	RG196, RG178	PE45004	\$17.63	\$16.92	\$16.40	\$16.04	71
			RG188-DS, RG316-DS with .235 inch D Hole	PE45189	\$26.64	\$25.31	\$23.98	\$22.91	72
			RG55, RG141, RG142, RG223, RG400 with .235 inch D Hole	PE4855	\$29.36	\$27.89	\$26.42	\$25.25	73
			RG58 with .235 inch D Hole	PE4857	\$23.41	\$22.24	\$21.07	\$20.13	74
			.100 inch, RG316, RG174, RG188, LMR-100, LMR-100A, LMR-100A-FR, PE-C100, PE-B100 with .235 inch D Hole	PE4859	\$29.26	\$27.80	\$26.33	\$25.16	75
			RG178, RG196 with .235 inch D Hole	PE4862	\$25.64	\$24.36	\$23.08	\$22.05	76
		Clamp/Solder	RG58, RG142, RG223, RG400, RG141, RG303, RG55, LMR-195, PE-C195, PE-P195 with .235 inch D Hole	PE4854	\$37.73	\$35.84	\$33.96	\$32.45	77
			RG174, RG316, RG188 with .235 inch D Hole	PE4858	\$41.95	\$39.85	\$37.76	\$36.08	78
			RG178, RG196 with .235 inch D Hole	PE4861	\$37.73	\$35.84	\$33.96	\$32.45	79
		Solder/Solder	RG58, RG55, RG141, RG142, RG223, RG400 with .235 inch D Hole	PE4856	\$25.10	\$23.85	\$22.59	\$21.59	80
			RG174, RG316, RG188 with .235 inch D Hole	PE4860	\$24.38	\$23.16	\$21.94	\$20.97	81
			RG178, RG196 with .235 inch D Hole	PE4863	\$24.52	\$23.29	\$22.07	\$21.09	82
PE-SR402AL, PE-SR402FL, RG402 with .235 inch D Hole			PE4864	\$35.60	\$33.82	\$32.04	\$30.62	83	
PE-SR405AL, PE-SR405FL, PE-SR405FLJ, PE-SR405TN, RG405 with .235 inch D Hole			PE4865	\$40.23	\$38.22	\$36.21	\$34.60	84	
Solder Cup with .235 inch D Hole			PE4868	\$24.22	\$23.01	\$21.80	\$20.83	85	
Terminal		Solder	Solder Cup with .235 inch D Hole	PE4871	\$24.02	\$22.82	\$21.62	\$20.66	86
			Thru Hole with .250 inch Diameter	PE4872	\$24.83	\$23.59	\$22.35	\$21.35	87
Female, 2 Hole Flange Mount									
Terminal		Solder	Solder Cup with .481 inch Hole Spacing	PE4867	\$29.30	\$27.84	\$26.37	\$25.20	88

Connectors







See Our Website For Current Pricing & Real-Time Stock Availability!

* Fits MIL-C-17 and equivalent cable versions only

Reverse Polarity SMA Connectors

Connection Method	Product Image	Attachment Cable/Contact	Coax Type / Termination Type	Model No.	PRICE				ROW
					1-24	25-49	50-99	100 +	
Female, 4 Hole Flange Mount									
Terminal		Solder	Solder Cup with .340 inch Hole Spacing	PE4866	\$20.29	\$19.28	\$18.26	\$17.45	89
Female Right Angle									
PCB Mount		Solder	Thru Hole with .200 inch x .067 inch Hole Spacing	PE4870	\$36.57	\$34.74	\$32.91	\$31.45	90
Female Right Angle, Bulkhead Mount									
PCB Mount		Solder	Thru Hole with .250 inch Diameter	PE4875	\$48.52	\$46.09	\$43.67	\$41.73	91

Reverse Thread SMA Connectors

Connection Method	Product Image	Attachment Cable/Contact	Coax Type / Termination Type	Model No.	PRICE				ROW
					1-24	25-49	50-99	100 +	
Male									
Cable Connectors		Crimp/Solder	RG55, RG141, RG142, RG223, RG400	PE44182	\$26.34	\$25.02	\$23.71	\$22.65	92
			RG58	PE44183	\$22.29	\$21.18	\$20.06	\$19.17	93
			RG174, RG316, RG188, PE-B100, PE-C100, .100 inch, LMR-100	PE44184	\$13.23	\$12.70	\$12.30	\$12.04	94
			RG178, RG196	PE44185	\$24.38	\$23.16	\$21.94	\$20.97	95
			RG188-DS, RG316-DS	PE45165	\$21.77	\$20.68	\$19.59	\$18.72	96
Male Right Angle									
Cable Connectors		Crimp/Solder	RG55, RG141, RG142, RG223, RG400	PE44186	\$44.04	\$41.84	\$39.64	\$37.87	97
			RG58	PE44187	\$37.24	\$35.38	\$33.52	\$32.03	98
			RG174, RG316, RG188	PE44188	\$47.13	\$44.77	\$42.42	\$40.53	99
			RG178, RG196	PE44189	\$47.13	\$44.77	\$42.42	\$40.53	1
Female									
Cable Connectors		Crimp/Solder	RG55, RG141, RG142, RG223, RG400	PE44190	\$31.08	\$29.53	\$27.97	\$26.73	2
			RG58	PE44191	\$25.60	\$24.32	\$23.04	\$22.02	3
			RG174, RG316, RG188	PE44192	\$27.70	\$26.32	\$24.93	\$23.82	4
			RG178, RG196	PE44193	\$31.73	\$30.14	\$28.56	\$27.29	5
PCB Mount		Solder	Thru Hole with .200 inch x .067 inch Hole Spacing	PE44198	\$31.08	\$29.53	\$27.97	\$26.73	6
			.062 inch End Launch	PE44201	\$31.08	\$29.53	\$27.97	\$26.73	7
			.062 inch End Launch	PE44202	\$31.08	\$29.53	\$27.97	\$26.73	8
Female, Bulkhead Mount									
Cable Connectors		Crimp/Solder	RG55, RG141, RG142, RG223, RG400 with .235 inch D Hole	PE44194	\$30.17	\$28.66	\$27.15	\$25.95	9
			RG58 with .235 inch D Hole	PE44195	\$27.06	\$25.71	\$24.35	\$23.27	10
			.100 inch, RG316, RG174, RG188, LMR-100, LMR-100A, LMR-100A-FR, PE-C100, PE-B100 with .235 inch D Hole	PE44196	\$25.78	\$24.49	\$23.20	\$22.17	11
			RG178, RG196 with .235 inch D Hole	PE44197	\$31.35	\$29.78	\$28.22	\$26.96	12
Female, 4 Hole Flange Mount									
Terminal		Solder	Solder Cup with .340 inch Hole Spacing	PE44200	\$34.78	\$33.04	\$31.30	\$29.91	13
Female Right Angle									
PCB Mount		Solder	Thru Hole with .200 inch x .067 inch Hole Spacing	PE44199	\$34.78	\$33.04	\$31.30	\$29.91	14

* Fits MIL-C-17 and equivalent cable versions only

Connectors

See Our Website For Current Pricing & Real-Time Stock Availability!

SMA, 2.92mm Torque Wrenches



Type	Bit Hex Size (in.)	Preset Torque (in.-lbs.)	Model No	1 Pc. Price	See Web for Volume Pricing			ROW
SMA, 2.92mm	5/16 inch	5 in.-lbs	PE5019-19	Call				
		8 in.-lbs	PE5011-1	\$228.23				

SMB Connectors



Connection Method	Product Image	Attachment Cable/Contact	Coax Type / Termination Type	Model No.	PRICE				ROW
					1-24	25-49	50-99	100 +	
Plug									
Cable Connectors		Crimp/Solder	RG174, RG316, RG188, LMR-100, PE-B100, PE-C100, .100 inch	PE4046	\$12.57	\$11.94	\$11.31	\$10.81	15
			RG178, RG196	PE4080	\$17.85	\$16.96	\$16.07	\$15.35	16
			RG316-DS, RG188-DS	PE44792	\$14.33	\$13.61	\$12.90	\$12.32	17
			RG58, RG303, RG141, PE-C195, PE-P195, LMR-195, .195 inch	PE4523	\$18.52	\$17.59	\$16.67	\$15.93	18
			RG55, RG142, RG223, RG400	PE4593	\$17.56	\$16.68	\$15.80	\$15.10	19
	Clamp/Solder	RG174, RG316, RG188, .100 inch, PE-B100, PE-C100, LMR-100	PE4200	\$17.23	\$16.37	\$15.51	\$14.82	20	
		RG178, RG196	PE4250	\$21.46	\$20.39	\$19.31	\$18.46	21	
		PE-SR405AL, PE-SR405FL, RG405	PE4356	\$17.05	\$16.37	\$15.86	\$15.52	22	
	Solder/Solder	RG405, PE-SR405FL, PE-SR405FLJ	PE45119	\$8.64	\$8.21	\$7.78	\$7.43	23	
PCB Mount		Solder	Thru Hole with .200 inch x .067 inch Hole Spacing	PE4366	\$24.86	\$23.62	\$22.37	\$21.38	24
Plug, Bulkhead Mount									
Terminal		Solder	Solder Cup with .177 inch D Hole	PE4288	\$34.80	\$33.06	\$31.32	\$29.93	25
Plug Right Angle									
Cable Connectors		Crimp/Solder	RG174, RG316, RG188, LMR-100, PE-B100, PE-C100, .100 inch	PE4052	\$9.69	\$9.21	\$8.72	\$8.33	26
			RG178, RG196	PE4159	\$20.15	\$19.14	\$18.14	\$17.33	27
			RG188-DS, RG316-DS	PE44818	\$15.61	\$14.83	\$14.05	\$13.42	28
			RG58, RG303, RG141, PE-C195, PE-P195, LMR-195, .195 inch	PE4522	\$22.39	\$21.27	\$20.15	\$19.26	29
			RG55, RG142, RG223, RG400	PE4595	\$20.83	\$19.79	\$18.75	\$17.91	30
	Clamp/Solder	RG174, RG316, RG188	PE4260	\$34.03	\$32.33	\$30.63	\$29.27	31	
		RG178, RG196	PE4261	\$39.25	\$37.29	\$35.33	\$33.76	32	
		PE-SR405AL, PE-SR405FL, PE-SR405FLJ, PE-SR405TN, RG405	PE4358	\$18.89	\$17.95	\$17.00	\$16.25	33	
	PCB Mount		Solder	Thru Hole with .200 inch x .067 inch Hole Spacing	PE4245	\$21.89	\$20.80	\$19.70	\$18.83
Jack									
Cable Connectors		Crimp/Solder	RG174, RG316, RG188, LMR-100, PE-B100, PE-C100, .100 inch	PE4096	\$14.83	\$14.09	\$13.35	\$12.75	35
			RG188-DS, RG316-DS	PE45158	\$12.67	\$12.04	\$11.40	\$10.90	36
			RG178, RG196	PE4926	\$26.53	\$25.20	\$23.88	\$22.82	37
			RG174, RG316, RG188, PE-B100, PE-C100, .100 inch, LMR-100	PE4268	\$31.52	\$30.26	\$29.31	\$28.68	38
			RG178, RG196	PE4269	\$26.78	\$25.44	\$24.10	\$23.03	39
	Clamp/Solder	PE-SR405AL, PE-SR405FL, RG405	PE4360	\$17.24	\$16.38	\$15.52	\$14.83	40	
		Thru Hole with .200 inch x .067 inch Hole Spacing	PE4174	\$7.46	\$7.09	\$6.71	\$6.42	41	
		Surface Mount	PE44119	\$10.02	\$9.52	\$9.02	\$8.62	42	
	PCB Mount		Solder	.062 inch End Launch	PE44129	\$22.55	\$21.42	\$20.30	\$19.39
.042 inch End Launch				PE44132	\$10.21	\$9.80	\$9.50	\$9.29	44
.062 inch End Launch				PE44135	\$20.21	\$19.20	\$18.19	\$17.38	45
.042 inch End Launch				PE44137	\$21.08	\$20.03	\$18.97	\$18.13	46

* Fits MIL-C-17 and equivalent cable versions only



Connectors

See Our Website For Current Pricing & Real-Time Stock Availability!

SMB Connectors

Connection Method	Product Image	Attachment Cable/Contact	Coax Type / Termination Type	Model No.	PRICE				ROW
					1-24	25-49	50-99	100 +	
Jack, Bulkhead Mount									
Cable Connectors		Crimp/Solder	RG174, RG316, RG188, LMR-100, PE-B100, PE-C100, .100 inch	PE4097	\$17.20	\$16.34	\$15.48	\$14.79	47
			RG178, RG196	PE4364	\$16.32	\$15.50	\$14.69	\$14.04	48
			RG55, RG141, RG142, RG223, RG400 with .177 inch D Hole	PE44048	\$34.58	\$32.85	\$31.12	\$29.74	49
			RG58	PE44094	\$27.87	\$26.48	\$25.08	\$23.97	50
			RG188-DS, RG316-DS	PE45159	\$13.98	\$13.28	\$12.58	\$12.02	51
	RG174, RG316, RG188 with .177 inch D Hole	PE4276	\$18.23	\$17.32	\$16.41	\$15.68	52		
		Clamp/Solder	PE-SR405AL, PE-SR405FL, RG405	PE4362	\$17.94	\$17.04	\$16.15	\$15.43	53
Terminal		Solder	Solder Cup with .177 inch D Hole	PE4167	\$7.81	\$7.42	\$7.03	\$6.72	54
			Solder Cup with .177 inch D Hole	PE4170	\$15.30	\$14.54	\$13.77	\$13.16	55
PCB Mount			Thru Hole with .177 inch D Hole	PE44123	\$21.10	\$20.26	\$19.62	\$19.20	56
Jack, 2 Hole Flange Mount									
Terminal		Solder	Solder Cup with .328 inch Hole Spacing	PE44139	\$31.52	\$29.94	\$28.37	\$27.11	57
Jack, 4 Hole Flange Mount									
Terminal		Solder	Solder Cup with .232 inch Hole Spacing	PE44142	\$27.37	\$26.00	\$24.63	\$23.54	58
Jack Right Angle									
PCB Mount		Solder	Thru Hole with .200 inch x .067 inch Hole Spacing	PE4177	\$12.46	\$11.84	\$11.21	\$10.72	59
			Surface Mount	PE44121	\$23.79	\$22.60	\$21.41	\$20.46	60
Jack Right Angle, Bulkhead Mount									
Terminal		Solder	Solder Cup with .177 inch D Hole	PE4284	\$29.13	\$27.67	\$26.22	\$25.05	61
PCB Mount			Thru Hole with .177 inch D Hole	PE44875	\$21.10	\$20.05	\$18.99	\$18.15	62

SMC Connectors













Connection Method	Product Image	Attachment Cable/Contact	Coax Type / Termination Type	Model No.	PRICE				ROW
					1-24	25-49	50-99	100 +	
Plug									
Cable Connectors		Crimp/Solder	RG174, RG316, RG188, LMR-100, PE-B100, PE-C100, .100 inch	PE4045	\$12.92	\$12.27	\$11.63	\$11.11	63
			RG178, RG196	PE4074	\$18.63	\$17.70	\$16.77	\$16.02	64
			RG188-DS, RG316-DS	PE45155	\$12.41	\$11.79	\$11.17	\$10.67	65
			RG55, RG142, RG223, RG400	PE45396	\$22.05	\$20.95	\$19.85	\$18.96	66
			PE-P195, PE-C195, RG58, RG141, RG303, .195 inch, LMR-195	PE4558	\$21.66	\$20.58	\$19.49	\$18.63	67
	RG174, RG316, RG188, LMR-100, PE-B100, PE-C100, .100 inch	PE4201	\$14.30	\$13.59	\$12.87	\$12.30	68		
	RG178, RG196	PE4202	\$18.28	\$17.37	\$16.45	\$15.72	69		
		Solder/Solder	PE-SR405AL, PE-SR405FL, PE-SR405FLJ, PE-SR405TN, RG405	PE44977	\$26.52	\$25.19	\$23.87	\$22.81	70
PCB Mount		Solder	Thru Hole with .200 inch x .067 inch Hole Spacing	PE4367	\$15.53	\$14.75	\$13.98	\$13.36	71

* Fits MIL-C-17 and equivalent cable versions only

Connectors

See Our Website For Current Pricing & Real-Time Stock Availability!

SMC Connectors

Connection Method	Product Image	Attachment Cable/Contact	Coax Type / Termination Type	Model No.	PRICE				ROW
					1-24	25-49	50-99	100 +	
Plug Right Angle									
Cable Connectors		Crimp/Solder	RG174, RG316, RG188, LMR-100, PE-B100, PE-C100, .100 inch	PE4051	\$16.93	\$16.08	\$15.24	\$14.56	72
			RG178, RG196	PE4160	\$17.62	\$16.74	\$15.86	\$15.15	73
			RG316-DS, RG188-DS	PE44876	\$15.77	\$14.98	\$14.19	\$13.56	74
			RG58, LMR-195	PE45193	\$19.88	\$18.89	\$17.89	\$17.10	75
		Clamp/Solder	RG55, RG142, RG223, RG400	PE4596	\$20.83	\$19.79	\$18.75	\$17.91	76
			RG174, RG316, RG188, LMR-100, PE-B100, PE-C100, .100 inch	PE4262	\$17.22	\$16.36	\$15.50	\$14.81	77
PCB Mount		Solder	RG178, RG196	PE4263	\$15.06	\$14.31	\$13.55	\$12.95	78
			PE-SR405AL, PE-SR405FL, RG405	PE4359	\$42.40	\$40.28	\$38.16	\$36.46	79
Jack									
Cable Connectors		Crimp/Solder	RG174, RG316, RG188, LMR-100, PE-B100, PE-C100, .100 inch	PE4094	\$18.23	\$17.32	\$16.41	\$15.68	81
			RG188-DS, RG316-DS	PE45156	\$16.30	\$15.49	\$14.67	\$14.02	82
			RG178, RG196	PE4927	\$35.31	\$33.54	\$31.78	\$30.37	83
PCB Mount		Solder	RG174, RG316, RG188	PE4270	\$32.87	\$31.23	\$29.58	\$28.27	84
			Thru Hole with .200 inch x .067 inch Hole Spacing	PE4175	\$9.89	\$9.40	\$8.90	\$8.51	85
			Surface Mount	PE44120	\$18.20	\$17.29	\$16.38	\$15.65	86
			.062 inch End Launch	PE44130	\$50.82	\$48.28	\$45.74	\$43.71	87
			.042 inch End Launch	PE44133	\$24.17	\$22.96	\$21.75	\$20.79	88
			.062 inch End Launch	PE44136	\$26.52	\$25.19	\$23.87	\$22.81	89
Jack, Bulkhead Mount									
Cable Connectors		Crimp/Solder	RG174, RG316, RG188, LMR-100, PE-B100, PE-C100, .100 inch with .177 inch D Hole	PE4095	\$17.20	\$16.34	\$15.48	\$14.79	91
			RG178, RG196	PE4365	\$32.20	\$30.59	\$28.98	\$27.69	92
			RG55, RG141, RG142, RG223, RG400	PE44047	\$25.74	\$24.45	\$23.17	\$22.14	93
			RG58	PE44095	\$25.74	\$24.45	\$23.17	\$22.14	94
			RG188-DS, RG316-DS with .177 inch D Hole	PE45157	\$15.38	\$14.61	\$13.84	\$13.23	95
		Clamp/Solder	RG174, RG316, RG188 with .177 inch D Hole	PE4278	\$31.35	\$29.78	\$28.22	\$26.96	96
RG178, RG196 with .177 inch D Hole			PE4279	\$31.35	\$29.78	\$28.22	\$26.96	97	
Terminal		Solder/Solder	RG405, PE-SR405FL, PE-SR405AL with .177 inch D Hole	PE45210	\$38.49	\$36.95	\$35.80	\$35.03	98
			Solder Cup with .177 inch D Hole	PE4107	\$14.56	\$13.83	\$13.10	\$12.52	99
PCB Mount		Solder	Solder Cup with .177 inch D Hole	PE4171	\$13.82	\$13.13	\$12.44	\$11.89	1
			Thru Hole with .177 inch D Hole	PE44124	\$32.47	\$30.85	\$29.22	\$27.92	2
			Thru Hole	PE45147	\$23.70	\$22.52	\$21.33	\$20.38	3
Jack, 4 Hole Flange Mount									
Terminal		Solder	Solder Cup with .232 inch Hole Spacing	PE44143	\$22.30	\$21.19	\$20.07	\$19.18	5
Jack Right Angle									
PCB Mount		Solder	Thru Hole with .200 inch x .067 inch Hole Spacing	PE4178	\$16.06	\$15.26	\$14.45	\$13.81	6
			Surface Mount	PE44122	\$7.91	\$7.51	\$7.12	\$6.80	7
Jack Right Angle, Bulkhead Mount									
Terminal		Solder	Solder Cup with .177 inch D Hole	PE4285	\$31.36	\$29.79	\$28.22	\$26.97	8

Connectors





See Our Website For Current Pricing & Real-Time Stock Availability!

* Fits MIL-C-17 and equivalent cable versions only

SMC Connectors











Connection Method	Product Image	Attachment Cable/Contact	Coax Type / Termination Type	Model No.	PRICE				ROW
					1-24	25-49	50-99	100 +	
Jack Right Angle, Bulkhead Mount									
PCB Mount		Solder	Thru Hole with .177 inch D Hole	PE44127	\$25.19	\$23.93	\$22.67	\$21.66	9

SMP Connectors

Connection Method	Product Image	Attachment Cable/Contact	Coax Type / Termination Type	Model No.	PRICE			ROW
					1 Pc.	See Web for Volume Pricing		
Male								
PCB Mount		Solder	.062 inch End Launch	PE44943	\$34.93	See Web for Volume Pricing		10
			.092 inch End Launch	PE44942	\$42.61			11
			Edge Launch	PE44955	\$32.29			12
			End Launch	PE44482	\$27.32			13
			End Launch	PE44777	\$13.50			14
			End Launch	PE44879	\$13.08			15
			End Launch	PE44880	\$13.08			16
			Surface Mount	PE44481	\$36.68			17
			Surface Mount	PE44944	\$53.32			18
			Surface Mount	PE44946	\$29.57			19
			Surface Mount	PE44947	\$82.53			20
			Surface Mount	PE44952	\$45.18			21
			Surface Mount	PE45278TR1	\$36.02			22
			Surface Mount	PE45278TR1500	\$28,600.56			23
			Thru Hole	PE44480	\$35.27			24
			Thru Hole	PE44775	\$15.30			25
			Thru Hole	PE44776	\$10.19			26
			Thru Hole	PE44840	\$10.19			27
			Thru Hole	PE44849	\$13.50			28
			Thru Hole	PE44910	\$33.72			29
			Thru Hole	PE44936	\$38.14			30
			Thru Hole	PE44937	\$40.07			31
			Thru Hole	PE44940	\$66.80			32
			Thru Hole	PE44941	\$34.72			33
			Thru Hole	PE44957	\$43.59			34
			Thru Hole	PE44958	\$49.54			35
Thru Hole	PE44959	\$52.65	36					
Thru Hole	PE44960	\$29.68	37					
Thru Hole	PE44965	\$30.86	38					
Thru Hole	PE44966	\$40.19	39					
Thru Hole	PE44967	\$32.14	40					
Thru Hole with .100 inch x .031 inch Hole Spacing	PE44348	\$33.62	41					
Terminal		Pin	PE44779	\$20.51			42	
		Pin	PE44780	\$20.89			43	
Male, Bulkhead Mount								
Cable Connectors		Solder/Solder	RG405, RG405 Tinned, PE-SR405FL, PE-SR405AL, PE-SR405FLJ, PE-SR405TN with 4.83 mm Diameter	PE44483	\$43.94	See Web for Volume Pricing		44
			PE-SR405AL, PE-SR405FL, PE-SR405FLJ, PE-SR405TN, RG405	PE44961	\$36.78			45
			RG405, PE-SR405FL, PE-SR405FLJ	PE45126	\$33.07			46
Male, 2 Hole Flange Mount								
Shroud		None	None	PE44935	\$17.79			47
			None	PE44907	\$17.61			48
			None	PE44916	\$18.48			49
			None	PE44948	\$19.01			50
			None	PE44949	\$18.85			51
			None	PE44950	\$19.20			52
Cable Connectors		Solder/Solder	RG405, PE-SR405FL, PE-SR405FLJ	PE45127	\$35.14			54

* Fits MIL-C-17 and equivalent cable versions only

SMP Connectors

Connection Method	Product Image	Attachment Cable/Contact	Coax Type / Termination Type	Model No.	PRICE				ROW
					1-24	25-49	50-99	100 +	
Male, 2 Hole Flange Mount									
Terminal		Solder	Pin	PE44938	\$44.94	\$42.69	\$40.45	\$38.65	55
Male, Press-In									
Shroud		None	None	PE44954	\$18.30	\$17.39	\$16.47	\$15.74	56
Male, Thread-In									
Shroud		None	None	PE44906	\$23.79	\$22.60	\$21.41	\$20.46	57
			None	PE44953	\$24.96	\$23.71	\$22.46	\$21.47	58
Terminal		Solder	Pin	PE44909	\$41.44	\$39.37	\$37.30	\$35.64	59
			Pin	PE44912	\$31.75	\$30.16	\$28.58	\$27.31	60
			Pin	PE44931	\$51.69	\$49.11	\$46.52	\$44.45	61
			Pin	PE44956	\$72.12	\$68.51	\$64.91	\$62.02	62
			Pin	PE44963	\$39.71	\$37.72	\$35.74	\$34.15	63
			Pin	PE44964	\$64.50	\$61.28	\$58.05	\$55.47	64
Male, Solder									
Shroud		None	None	PE44932	\$19.20	\$18.24	\$17.28	\$16.51	65
Terminal		Solder	Pin	PE44918	\$33.85	\$32.16	\$30.47	\$29.11	66
			Pin	PE44919	\$34.79	\$33.05	\$31.31	\$29.92	67
			Pin	PE44920	\$26.20	\$24.89	\$23.58	\$22.53	68
			Pin	PE44921	\$29.98	\$28.48	\$26.98	\$25.78	69
			Pin	PE44922	\$34.79	\$33.05	\$31.31	\$29.92	70
			Pin	PE44923	\$31.43	\$29.86	\$28.29	\$27.03	71
			Pin	PE44924	\$33.20	\$31.54	\$29.88	\$28.55	72
			Pin	PE44925	\$28.88	\$27.44	\$25.99	\$24.84	73
			Pin	PE44926	\$32.12	\$30.51	\$28.91	\$27.62	74
			Pin	PE44927	\$28.31	\$26.89	\$25.48	\$24.35	75
			Pin	PE44928	\$34.46	\$32.74	\$31.01	\$29.64	76
			Pin	PE44930	\$27.78	\$26.39	\$25.00	\$23.89	77
Pin	PE44933	\$40.86	\$38.82	\$36.77	\$35.14	78			
Pin	PE44945	\$48.57	\$46.14	\$43.71	\$41.77	79			
Male Right Angle									
PCB Mount		Solder	Thru Hole	PE44934	\$58.69	\$55.76	\$52.82	\$50.47	80
Female									
Cable Connectors		Solder/Solder	RG178, RG196	PE44655	\$51.08	\$48.53	\$45.97	\$43.93	81
			PE-047SR, PE-SR047AL, PE-SR047FL	PE44785	\$23.83	\$22.64	\$21.45	\$20.49	82
			PE-SR405AL, PE-SR405FL, PE-SR405FLJ, PE-SR405TN, RG405	PE44786	\$21.80	\$20.71	\$19.62	\$18.75	83
			.086 Microporous	PE44917	\$28.74	\$27.30	\$25.87	\$24.72	84
			RG405, PE-SR405AL, PE-SR405FL, PE-SR405FLJ	PE45285	\$9.63	\$9.15	\$8.67	\$8.28	85
			RG178, RG196	PE45287	\$9.85	\$9.36	\$8.87	\$8.47	86
PCB Mount		Solder	Thru Hole	PE44939	\$69.47	\$66.00	\$62.52	\$59.74	87
Cable Connectors			PE-047SR, PE-SR047AL, PE-SR047FL	PE45277	\$4.43	\$4.25	\$4.12	\$4.03	88
Female Right Angle									
Cable Connectors		Crimp/Crimp	RG178, RG196	PE45290	\$9.58	\$9.10	\$8.62	\$8.24	89

Connectors

See Our Website For Current Pricing & Real-Time Stock Availability!

* Fits MIL-C-17 and equivalent cable versions only

SMP Connectors

Connection Method	Product Image	Attachment Cable/Contact	Coax Type / Termination Type	Model No.	PRICE				ROW
					1-24	25-49	50-99	100 +	
Female Right Angle									
Cable Connectors		Crimp/Solder	RG316, RG174, LMR-100	PE45128	\$14.23	\$13.52	\$12.81	\$12.24	90
			PE-047SR, PE-SR047AL, PE-SR047FL	PE44274	\$52.94	\$50.29	\$47.65	\$45.53	91
		Solder/Solder	PE-SR405AL, PE-SR405FL, PE-SR405FLJ, PE-SR405TN, RG405	PE44275	\$33.74	\$32.05	\$30.37	\$29.02	92
			PE-SR405AL, PE-SR405FL, PE-SR405FLJ, PE-SR405TN, RG405	PE44908	\$33.71	\$32.02	\$30.34	\$28.99	93
			PE-047SR, PE-SR047FL, PE-SR047AL	PE44911	\$32.40	\$30.78	\$29.16	\$27.86	94
			RG405, PE-SR405FL, PE-SR405FLJ	PE44913	\$57.19	\$54.33	\$51.47	\$49.18	95
			RG178, RG196	PE44914	\$38.87	\$36.93	\$34.98	\$33.43	96
		Solder	RG405, PE-SR405FL, PE-SR405FLJ	PE44915	\$28.26	\$26.85	\$25.43	\$24.30	97
			RG405, PE-SR405AL, PE-SR405FL, PE-SR405FLJ	PE45248	\$10.32	\$9.80	\$9.29	\$8.88	98
PE-047SR, PE-SR047AL, PE-SR047FL			PE45249	\$12.52	\$11.89	\$11.27	\$10.77	99	

SSMA Connectors











Connection Method	Product Image	Attachment Cable/Contact	Coax Type / Termination Type	Model No.	PRICE				ROW
					1-24	25-49	50-99	100 +	
Male									
Cable Connectors		Crimp/Solder	RG174, RG316, RG188, LMR-100, PE-B100, PE-C100, .100 inch	PE44379	\$24.83	\$23.59	\$22.35	\$21.35	1
			RG178, RG196	PE44381	\$28.55	\$27.12	\$25.70	\$24.55	2
			RG188-DS, RG316-DS	PE44416	\$23.52	\$22.34	\$21.17	\$20.23	3
		Solder/Solder	RG174, RG316, RG188	PE4184	\$25.29	\$24.03	\$22.76	\$21.75	4
			RG178, RG196	PE4199	\$27.06	\$25.71	\$24.35	\$23.27	5
			PE-SR405AL, PE-SR405FL, PE-SR405FLJ, RG405	PE44383	\$35.22	\$33.46	\$31.70	\$30.29	6
			PE-034SR	PE44440	\$29.28	\$27.82	\$26.35	\$25.18	7
			PE-047SR, PE-SR047AL, PE-SR047FL	PE44441	\$34.83	\$33.09	\$31.35	\$29.95	8
PCB Mount		Solder	Thru Hole with .200 inch x .067 inch Hole Spacing	PE44430	\$26.42	\$25.10	\$23.78	\$22.72	10
Male, 2 Hole Flange Mount									
Terminal		Solder	Solder Cup with .328 inch Hole Spacing	PE44431	\$30.17	\$28.66	\$27.15	\$25.95	11
Male, 4 Hole Flange Mount									
Terminal		Solder	Solder Cup with .232 inch Hole Spacing	PE44432	\$26.90	\$25.56	\$24.21	\$23.13	12
Male Right Angle									
Cable Connectors		Crimp/Solder	RG174, RG316, RG188, PE-B100, PE-C100, .100 inch, LMR-100	PE44378	\$27.62	\$26.24	\$24.86	\$23.75	13
			RG178, RG196	PE44380	\$56.81	\$53.97	\$51.13	\$48.86	14
			RG188-DS, RG316-DS	PE44418	\$34.47	\$32.75	\$31.02	\$29.64	15
		Solder/Solder	PE-SR405AL, PE-SR405FL, PE-SR405FLJ, RG405	PE44384	\$41.02	\$38.97	\$36.92	\$35.28	16
			RG174, RG316, RG188	PE44401	\$35.04	\$33.29	\$31.54	\$30.13	17
			RG178, RG196	PE44402	\$33.75	\$32.40	\$31.39	\$30.71	18
			RG188-DS, RG316-DS	PE44419	\$29.96	\$28.46	\$26.96	\$25.77	19
			PE-034SR	PE44420	\$56.52	\$53.69	\$50.87	\$48.61	20
			PE-047SR, PE-SR047AL, PE-SR047FL	PE44421	\$46.99	\$44.64	\$42.29	\$40.41	21
			Female						
Cable Connectors		Crimp/Solder	RG174, RG316, RG188, PE-B100, PE-C100, .100 inch, LMR-100	PE44385	\$29.52	\$28.04	\$26.57	\$25.39	22
			RG178, RG196	PE44386	\$46.86	\$44.52	\$42.17	\$40.30	23
			RG188-DS, RG316-DS	PE44422	\$27.77	\$26.38	\$24.99	\$23.88	24

* Fits MIL-C-17 and equivalent cable versions only

Connectors

See Our Website For Current Pricing & Real-Time Stock Availability!

SSMA Connectors

Connection Method	Product Image	Attachment Cable/Contact	Coax Type / Termination Type	Model No.	PRICE				ROW
					1-24	25-49	50-99	100 +	
Female									
Cable Connectors		Solder/Solder	PE-SR405AL, PE-SR405FL, PE-SR405FLJ, RG405	PE44387	\$29.39	\$27.92	\$26.45	\$25.28	25
			RG174, RG316, RG188	PE44403	\$26.26	\$24.95	\$23.63	\$22.58	26
			RG178, RG196	PE44404	\$29.18	\$27.72	\$26.26	\$25.09	27
			PE-034SR	PE44424	\$34.41	\$32.69	\$30.97	\$29.59	28
			PE-047SR, PE-SR047AL, PE-SR047FL	PE44425	\$32.81	\$31.17	\$29.53	\$28.22	29
PCB Mount		Solder	Thru Hole with .200 inch x .067 inch Hole Spacing	PE44391	\$34.64	\$32.91	\$31.18	\$29.79	30
Female, Bulkhead Mount									
Cable Connectors		Crimp/Solder	.100 inch, RG316, RG174, RG188, LMR-100, LMR-100A, LMR-100A-FR, PE-C100, PE-B100 with .177 inch D Hole	PE44388	\$43.71	\$41.52	\$39.34	\$37.59	31
			RG178, RG196 with .177 inch D Hole	PE44389	\$36.60	\$34.77	\$32.94	\$31.48	32
			RG188-DS, RG316-DS with .177 inch D Hole	PE44426	\$30.37	\$28.85	\$27.33	\$26.12	33
		Solder/Solder	PE-SR405AL, PE-SR405FL, RG405 with .177 inch D Hole	PE44390	\$34.78	\$33.04	\$31.30	\$29.91	34
			RG174, RG316, RG188 with .177 inch D Hole	PE44405	\$25.71	\$24.42	\$23.14	\$22.11	35
			RG178, RG196 with .177 inch D Hole	PE44406	\$27.77	\$26.38	\$24.99	\$23.88	36
			RG188-DS, RG316-DS with .177 inch D Hole	PE44427	\$24.52	\$23.29	\$22.07	\$21.09	37
			PE-034SR with .177 inch D Hole	PE44428	\$45.56	\$43.28	\$41.00	\$39.18	38
			PE-047SR, PE-SR047AL, PE-SR047FL with .177 inch D Hole	PE44429	\$48.30	\$45.89	\$43.47	\$41.54	39
	Terminal		Solder	Turret with .177 inch D Hole	PE44392	\$37.50	\$35.63	\$33.75	\$32.25
Solder Cup with .177 inch D Hole				PE44393	\$31.49	\$29.92	\$28.34	\$27.08	41
PCB Mount		Solder	.042 inch End Launch	PE45405	\$27.23	\$25.87	\$24.51	\$23.42	42
			.062 inch End Launch	PE45406	\$27.23	\$25.87	\$24.51	\$23.42	43
Female, 2 Hole Flange Mount									
Cable Connectors		Solder/Solder	PE-047SR, PE-SR047AL, PE-SR047FL with .328 inch Hole Spacing	PE44436	\$44.20	\$41.99	\$39.78	\$38.01	44
			PE-SR405AL, PE-SR405FL, PE-SR405FLJ, RG405 with .328 inch Hole Spacing	PE44437	\$23.31	\$22.14	\$20.98	\$20.05	45
Terminal		Solder	Solder Cup with .328 inch Hole Spacing	PE44395	\$48.29	\$45.88	\$43.46	\$41.53	46
			Pin with .328 inch Hole Spacing	PE44433	\$48.26	\$45.85	\$43.43	\$41.50	47
Female, 4 Hole Flange Mount									
Cable Connectors		Solder/Solder	PE-047SR, PE-SR047AL, PE-SR047FL with .232 inch Hole Spacing	PE44438	\$45.07	\$42.82	\$40.56	\$38.76	48
			PE-SR405AL, PE-SR405FL, RG405 with .232 inch Hole Spacing	PE44439	\$37.73	\$35.84	\$33.96	\$32.45	49
Terminal		Solder	Solder Cup with .232 inch Hole Spacing	PE44394	\$37.25	\$35.39	\$33.53	\$32.04	50
			Pin with .232 inch Hole Spacing	PE44434	\$43.86	\$41.67	\$39.47	\$37.72	51
Female Right Angle									
PCB Mount		Solder	Thru Hole with .200 inch x .067 inch Hole Spacing	PE44435	\$49.05	\$46.60	\$44.15	\$42.18	52

Connectors







See Our Website For Current Pricing & Real-Time Stock Availability!

SSMB Connectors







Connection Method	Product Image	Attachment Cable/Contact	Coax Type / Termination Type	Model No.	PRICE				ROW
					1-24	25-49	50-99	100 +	
Plug									
Cable Connectors		Crimp/Solder	RG174, RG316, RG188, LMR-100, PE-B100, PE-C100, .100 inch	PE4017	\$30.99	\$29.44	\$27.89	\$26.65	53
			RG178, RG196	PE4019	\$28.70	\$27.27	\$25.83	\$24.68	54
			RG188-DS, RG316-DS	PE45153	\$28.21	\$26.80	\$25.39	\$24.26	55

* Fits MIL-C-17 and equivalent cable versions only

SSMB Connectors

Connection Method	Product Image	Attachment Cable/Contact	Coax Type / Termination Type	Model No.	PRICE				ROW
					1-24	25-49	50-99	100 +	
Plug Right Angle									
Cable Connectors		Crimp/Solder	RG174, RG179, RG316, RG188, PE-B100, PE-C100, .100 inch, LMR-100	PE4334	\$53.86	\$51.17	\$48.47	\$46.32	56
			RG188-DS, RG316-DS	PE45162	\$27.77	\$26.66	\$25.83	\$25.27	57
			RG178, RG196	PE45195	\$19.23	\$18.27	\$17.31	\$16.54	58
Jack									
PCB Mount		Solder	Thru Hole with .100 inch x .031 inch Hole Spacing	PE4340	\$14.38	\$13.66	\$12.94	\$12.37	59
Jack, Bulkhead Mount									
Cable Connectors		Crimp/Solder	.100 inch, RG316, RG174, RG188, LMR-100, LMR-100A, LMR-100A-FR, PE-C100, PE-B100 with .126 inch D Hole	PE4336	\$39.34	\$37.37	\$35.41	\$33.83	60
			RG178, RG196 with .126 inch D Hole	PE4337	\$33.86	\$32.17	\$30.47	\$29.12	61
			RG316-DS, RG188-DS with .126 inch D Hole	PE44842	\$29.88	\$28.39	\$26.89	\$25.70	62
Terminal		Solder	Turret with .126 inch D Hole	PE4338	\$25.32	\$24.05	\$22.79	\$21.78	63
			Turret with .126 inch D Hole	PE4339	\$26.27	\$24.96	\$23.64	\$22.59	64
Jack, 4 Hole Flange Mount									
Terminal		Solder	Tab with .164 inch x .067 inch Hole Spacing	PE44455	\$25.52	\$24.24	\$22.97	\$21.95	65
Jack Right Angle									
PCB Mount		Solder	Thru Hole with .100 inch x .031 inch Hole Spacing	PE4341	\$25.92	\$24.62	\$23.33	\$22.29	66

SSMC Connectors









Connection Method	Product Image	Attachment Cable/Contact	Coax Type / Termination Type	Model No.	PRICE				ROW
					1-24	25-49	50-99	100 +	
Plug									
Cable Connectors		Crimp/Solder	RG316, RG174, RG188	PE45209	\$14.69	\$13.96	\$13.22	\$12.63	67
			RG178, RG196	PE45490	\$26.37	\$25.05	\$23.73	\$22.68	68
			LMR-100A, RG188, RG174, PE-C100-LSZH, PE-B100, LMR-100A-FR, RG316	PE45491	\$24.15	\$22.94	\$21.74	\$20.77	69
		Clamp/Solder	RG188-DS, RG316-DS	PE45492	\$25.77	\$23.97	\$22.16	\$20.62	70
			PE-SR405AL, PE-SR405FL, PE-SR405FLJ, PE-SR405TN, RG405	PE45365	\$23.48	\$22.31	\$21.13	\$20.19	71
			PE-047SR, PE-SR047AL, PE-SR047FL	PE45366	\$23.73	\$22.54	\$21.36	\$20.41	72
Plug Right Angle									
Cable Connectors		Crimp/Solder	RG178, RG196	PE45496	\$18.27	\$17.36	\$16.44	\$15.71	73
			RG316, RG188, RG174, PE-C100-LSZH, PE-B100, LMR-100A-FR, LMR-100A	PE45497	\$20.84	\$19.80	\$18.76	\$17.92	74
			RG316-DS, RG188-DS	PE45498	\$20.53	\$19.09	\$17.66	\$16.42	75
	Solder/Solder	PE-SR405AL, PE-SR405FL, PE-SR405FLJ, PE-SR405TN, RG405	PE45384	\$20.50	\$19.48	\$18.45	\$17.63	76	
		PE-047SR, PE-SR047AL, PE-SR047FL	PE45385	\$23.59	\$22.41	\$21.23	\$20.29	77	
PCB Mount		Solder	Thru Hole	PE45379	\$29.31	\$27.84	\$26.38	\$25.21	78
Jack									
PCB Mount		Solder	Surface Mount	PE45376	\$17.00	\$16.15	\$15.30	\$14.62	79
Jack, Bulkhead Mount									
Cable Connectors		Crimp/Solder	RG-178, RG-196	PE45493	\$22.54	\$21.41	\$20.29	\$19.38	80
			RG316, RG188	PE45494	\$22.27	\$21.16	\$20.04	\$19.15	81

* Fits MIL-C-17 and equivalent cable versions only

Connectors

See Our Website For Current Pricing & Real-Time Stock Availability!

SSMC Connectors

Connection Method	Product Image	Attachment Cable/Contact	Coax Type / Termination Type	Model No.	PRICE				ROW
					1 Pc.	See Web for Volume Pricing			
Jack, Bulkhead Mount									
Cable Connectors		Clamp/Solder	PE-SR405AL, PE-SR405FL, PE-SR405FLJ, PE-SR405TN, RG405	PE45370	\$16.92				82
			PE-047SR, PE-SR047AL, PE-SR047FL	PE45371	\$23.45				83
Terminal		Solder	Turret	PE45375	\$18.41				84
			Turret	PE45390	\$17.00				85
Jack, 2 Hole Flange Mount									
Terminal		Solder	Solder Cup	PE45380	\$109.65			See Web for Volume Pricing	86
Jack, 4 Hole Flange Mount									
Terminal		Solder	Solder Cup	PE45391	\$62.83				87
Jack Right Angle									
PCB Mount		Solder	Surface Mount	PE45377	\$27.69				88
Jack Right Angle, Bulkhead Mount									
Cable Connectors		Crimp/Solder	PE-SR405AL, PE-SR405FL, PE-SR405FLJ, PE-SR405TN, RG405	PE45387	\$32.86			See Web for Volume Pricing	89
			RG178, RG196	PE45499	\$20.19				90
		Solder/Solder	PE-047SR, PE-SR047AL, PE-SR047FL	PE45388	\$36.55				91
Terminal		Solder	Turret	PE45378	\$38.80				92
PCB Mount			Turret	PE45389	\$34.30				93

Connectors









See Our Website For Current Pricing & Real-Time Stock Availability!

TNC Connectors

Connection Method	Product Image	Attachment Cable/Contact	Coax Type / Termination Type	Model No.	PRICE				ROW
					1-24	25-49	50-99	100 +	
Male									
Cable Connectors		Crimp/Crimp	RG55, RG142, RG223, RG400, RG141	PE4047	\$12.75	\$12.11	\$11.48	\$10.97	94
			RG174, RG316, RG188, LMR-100, PE-B100, PE-C100, .100 inch	PE4302	\$19.74	\$18.75	\$17.77	\$16.98	95
			PE-C200, LMR-200	PE44804	\$9.82	\$9.33	\$8.84	\$8.45	96
			RG188-DS, RG316-DS	PE45161	\$19.97	\$18.97	\$17.97	\$17.17	97
			RG59*, RG62*, RG71	PE4071	\$12.62	\$11.99	\$11.36	\$10.85	98
		Crimp/Solder	RG58, RG303, RG141, PE-C195, PE-P195, LMR-195, .195 inch	PE4156	\$7.56	\$7.18	\$6.80	\$6.50	99
			PE-C200	PE44062	\$17.56	\$16.68	\$15.80	\$15.10	1
			PE-C400, PE-B400, PE-B405, LMR-400, LMR-400-DB, LMR-400-UF, .400 inch	PE44293	\$33.74	\$32.05	\$30.37	\$29.02	2
			RG213, RG8	PE4446	\$18.82	\$17.88	\$16.94	\$16.19	3
			RG214, RG9, RG225, RG393	PE4447	\$28.36	\$26.94	\$25.52	\$24.39	4
			PE-C240, RG8X, .240 inch, LMR-240, LMR-240-DB, LMR-240-UF, B7808A	PE44634	\$13.32	\$12.65	\$11.99	\$11.46	5
			RG122, RG58 Plenum, RG58-P	PE45065	\$6.22	\$5.91	\$5.60	\$5.35	6
			LMR-100, PE-C100, RG174, RG188, RG316	TC-100-TM	\$18.50	\$18.50	\$18.50	\$18.50	7
			LMR-195, PE-C195	TC-195-TM-X	\$15.25	\$15.25	\$15.25	\$15.25	8
			LMR-240, PE-C240	TC-240-TM-X	\$9.25	\$9.25	\$9.25	\$9.25	9
LMR-400, PE-C400	TC-400-TM-X	\$11.25	\$11.25	\$11.25	\$11.25	10			

* Fits MIL-C-17 and equivalent cable versions only

TNC Connectors

Connection Method	Product Image	Attachment Cable/Contact	Coax Type / Termination Type	Model No.	PRICE			ROW
					1 Pc.	See Web for Volume Pricing		
Male								
Cable Connectors		Clamp/Solder	RG58, RG55, RG141, RG142, RG223, RG400, RG303, PE-C195, PE-P195, LMR-195	PE4067	\$25.40	See Web for Volume Pricing		11
			RG213, RG214, RG8, RG9, RG11*, RG225, RG393, RG144*, RG215, RG216*	PE4088	\$19.46			12
			PE-SR405AL, PE-SR405FL, RG405	PE4142	\$19.96			13
			PE-SR402AL, PE-SR402FL, RG402	PE4143	\$21.96			14
			RG59*, RG62*, RG71	PE4154	\$16.02			15
			RG174, RG316, RG188	PE4303	\$15.21			16
			PE-C200	PE44061	\$15.96			17
			RG178, RG196	PE4448	\$19.17			18
			PE-C400, PE-B400, PE-B405, LMR-400, LMR-400-DB, LMR-400-UF, .400 inch	PE4449	\$19.64			19
			PE-P300LL	PE44810	\$100.73			20
			PE-P142LL	PE44815	\$60.95			21
			RG8X, PE-C240, .240 inch, B7808A, LMR-240	PE45437	\$16.30			22
			PE-P160LL	PE45443	\$80.44			23
		Solder/Solder	PE-SR405AL, PE-SR405FL, PE-SR405FLJ, PE-SR405TN, RG405	PE44708	\$14.69			24
			PE-SR402AL, PE-SR402FL, PE-SR402FLJ, PE-SR402TN, RG402	PE44709	\$14.69			25
			PE-SR402AL, PE-SR402FL, PE-SR402FLJ, PE-SR402TN, RG402 with .480 inch D Hole	PE4648	\$31.48			26
			PE-SR405AL, PE-SR405FL, RG405	PE4649	\$29.00			27
			PE-SR401AL, PE-SR401FL, RG401	PE4909	\$66.44			28
			PE-047SR, PE-SR047AL, PE-SR047FL	PE4975	\$28.27			29
		Crimp/Non-Solder Contact	LMR-200, PE-C200	EZ-200-TM-X	\$20.75			30
			LMR-240, PE-C240	EZ-240-TM-X	\$13.50			31
			LMR-400, PE-C400, PE-B400, PE-B405	EZ-400-TM-X	\$12.75			32
			LMR-600, PE-C600	EZ-600-TM-X	\$19.00			33
Male, 4 Hole Flange Mount								
Terminal		Solder	Pin with .531 inch Hole Spacing	PE44654	\$74.06			34
			Solder Cup with .531 inch Hole Spacing	PE4470	\$22.42			35
Male Right Angle								
Cable Connectors		Crimp/Crimp	RG58, RG303, RG141, PE-C195, PE-P195, LMR-195, .195 inch	PE4451	\$25.28	See Web for Volume Pricing		36
				Crimp/Solder	RG55, RG141, RG142, RG223, RG400			PE4450
	RG174, RG316, RG188, .100 inch, PE-B100, PE-C100, LMR-100	PE4455			\$26.47			38
	PE-C240, RG8X, .240 inch, LMR-240, LMR-240-DB, LMR-240-UF, B7808A	PE44635			\$24.99			39
	PE-C200, LMR-200	PE44846			\$19.14			40
	RG188-DS, RG316-DS	PE45174			\$22.72			41
	LMR-400, PE-C400	TC-400-TM-RA-D			\$24.25			42
		Clamp/Solder	RG58, RG55, RG141, RG142, RG223, RG400, RG303, PE-C195, PE-P195, LMR-195	PE4054	\$26.81			43
			RG213, RG214, RG8, RG9, RG11*, RG225, RG393, RG144*, RG216*, RG215	PE4146	\$35.95			44
			RG59*, RG62*	PE4452	\$46.62			45
			RG174, RG316, RG188	PE4454	\$20.32			46
			PE-P142LL	PE44812	\$146.16			47
		Solder/Solder	PE-SR405AL, PE-SR405FL, PE-SR405FLJ, PE-SR405TN, RG405	PE44710	\$16.03			49
PE-SR402AL, PE-SR402FL, PE-SR402FLJ, PE-SR402TN, RG402			PE44711	\$15.74	50			
Female								
Cable Connectors		Crimp/Solder	RG55, RG142, RG223, RG400	PE4457	\$14.75			51
			RG58, RG303, RG141, PE-C195, PE-P195, LMR-195, .195 inch	PE4458	\$15.84			52
			RG59*, RG62*, RG71	PE4459	\$17.05			53
			RG174, RG316, RG188, PE-B100, PE-C100, .100 inch, LMR-100	PE4462	\$20.30			54
			PE-C240, RG8X, .240 inch, LMR-240, LMR-240-DB, LMR-240-UF, B7808A	PE44636	\$18.66			55
			RG316, RG174, LMR-100	PE45143	\$9.92			56

* Fits MIL-C-17 and equivalent cable versions only

Connectors

See Our Website For Current Pricing & Real-Time Stock Availability!

TNC Connectors





Connection Method	Product Image	Attachment Cable/Contact	Coax Type / Termination Type	Model No.	PRICE			ROW
					1 Pc.	See Web for Volume Pricing		
Female								
Cable Connectors		Clamp/Solder	RG58, RG55, RG141, RG142, RG223, RG400, RG303, PE-C195, PE-P195, LMR-195	PE4068	\$13.83			57
			PE-SR405AL, PE-SR405FL, RG405	PE4144	\$21.95			58
			PE-SR402AL, PE-SR402FL, RG402	PE4145	\$21.95			59
			RG213, RG214, RG8, RG9, RG11*, RG225, RG393, RG144*, RG216*, RG215	PE4155	\$37.98			60
			RG59*, RG62*, RG71	PE4460	\$15.49			61
			RG174, RG316, RG188	PE4461	\$15.64			62
			RG178, RG196	PE4463	\$17.56			63
		Solder/Solder	PE-SR405AL, PE-SR405FL, PE-SR405FLJ, PE-SR405TN, RG405	PE44712	\$12.60			64
			PE-SR402AL, PE-SR402FL, PE-SR402FLJ, PE-SR402TN, RG402	PE44713	\$14.69			65
Female, Bulkhead Mount								
Cable Connectors		Crimp/Solder	RG58, RG303, RG141, PE-C195, PE-P195, LMR-195, .195 inch with .480 inch D Hole	PE4151	\$20.77	See Web for Volume Pricing		66
			RG55, RG142, RG223, RG400 with .480 inch D Hole	PE4153	\$19.16		67	
			RG59*, RG62* with .480 inch D Hole	PE4465	\$23.90		68	
			RG174, RG316, RG188, LMR-100, PE-B100, PE-C100, .100 inch with .480 inch D Hole	PE4466	\$25.22		69	
			RG174, RG316, RG188, .100 inch, PE-B100, PE-C100, LMR-100	PE44899	\$60.76		70	
			RG174, RG316, RG188, .100 inch, PE-B100, PE-C100, LMR-100	PE44900	\$60.76		71	
			RG188-DS, RG316-DS with .480 inch D Hole	PE45177	\$22.28		72	
			PE-SR405AL, PE-SR405FL, RG405 with .480 inch D Hole	PE4149	\$26.26		73	
			PE-SR402AL, PE-SR402FL, RG402 with .480 inch D Hole	PE4150	\$26.26		74	
		Clamp/Solder	RG58, RG142, RG223, RG400, RG141, RG303, RG55, PE-C195, PE-P195 with .480 inch D Hole	PE4152	\$20.79	75		
			RG174, RG316, RG188 with .480 inch D Hole	PE4304	\$21.56	76		
			RG59*, RG62*, RG71 with .480 inch D Hole	PE4464	\$31.64	77		
			RG178, RG196 with .480 inch D Hole	PE4467	\$20.32	78		
			PE-P142LL	PE44811	\$98.29	79		
			PE-047SR, PE-SR047AL, PE-SR047FL	PE44897	\$33.02	80		
			PE-P160LL	PE45444	\$102.71	81		
				Solder/Solder	PE-SR405AL, PE-SR405FL, PE-SR405FLJ, RG405 with .480 inch D Hole	PE4147	\$76.60	82
					PE-SR402AL, PE-SR402FL, RG402 with .480 inch D Hole	PE4148	\$70.81	83
PE-SR405AL, PE-SR405FL, PE-SR405FLJ, PE-SR405TN, RG405	PE44714	\$17.64			84			
Terminal		Solder	Solder Cup with .410 inch D Hole	PE4063	\$24.61	See Web for Volume Pricing	87	
			Solder Cup with .350 inch D Hole	PE4065	\$14.86		88	
			Eyelet with .350 inch D Hole	PE4305	\$33.44		89	
			Solder Cup with .350 inch D Hole	PE4306	\$13.35		90	
			Solder Cup with .480 inch D Hole	PE4468	\$18.65		91	
			Eyelet with .480 inch D Hole	PE4469	\$43.85		92	
PCB Mount		Solder	Edge Mount	PE44894	\$67.67		93	
Terminal		Solder	None	PE45130	\$12.67		94	
Cable Connectors		Solder	RG178, RG196	PE45132	\$22.25		95	
Female, 4 Hole Flange Mount								
Cable Connectors		Clamp/Solder	RG316-DS, RG188-DS	PE44901	\$35.66			96

Connectors

See Our Website For Current Pricing & Real-Time Stock Availability!

* Fits MIL-C-17 and equivalent cable versions only

TNC Connectors



Connection Method	Product Image	Attachment Cable/Contact	Coax Type / Termination Type	Model No.	PRICE				ROW
					1-24	25-49	50-99	100 +	
Female, 4 Hole Flange Mount									
Terminal		Solder	Solder Cup with .500 inch Threaded Hole Spacing	PE4064	\$14.63	\$13.90	\$13.17	\$12.58	97
			Solder Cup with .500 inch Hole Spacing	PE4064SP	\$21.79	\$20.70	\$19.61	\$18.74	98
Female Right Angle									
PCB Mount		Solder/Solder	Thru Hole with .380 inch x .083 inch Hole Spacing	PE44659	\$16.03	\$15.23	\$14.43	\$13.79	99
Female Right Angle, Bulkhead Mount									
Cable Connectors		Crimp/Solder	PE-C200, LMR-200 with .480 inch D Hole	PE44847	\$22.89	\$21.75	\$20.60	\$19.69	1
Terminal		Solder	Solder Cup with .361 inch D Hole	PE4471	\$32.20	\$30.59	\$28.98	\$27.69	2
PCB Mount			Surface Mount	PE44892	\$70.57	\$67.04	\$63.51	\$60.69	3

TNC Torque Wrenches



Type	Bit Hex Size (in.)	Preset Torque (in.-lbs.)	Model No	1-9	10-24	25-49	50+	ROW
TNC	5/8 inch	14 in-lbs	PE5011-4	\$333.13	\$316.47	\$299.82	\$286.49	
	9/16 inch	13 in-lbs	PE5011-8	\$314.28	\$298.57	\$282.85	\$270.28	
	5/8 inch	12 in-lbs	PE5019-10	\$222.15	\$211.04	\$199.94	\$191.05	

Reverse Polarity TNC Connectors











Connection Method	Product Image	Attachment Cable/Contact	Coax Type / Termination Type	Model No.	PRICE				ROW
					1-24	25-49	50-99	100 +	
Male									
Cable Connectors		Crimp/Crimp	LMR-200, PE-C200	PE45283	\$19.33	\$18.36	\$17.40	\$16.62	4
				Crimp/Solder	PE-C240, RG8X, .240 inch, LMR-240, LMR-240-DB, LMR-240-UF, B7808A	PE44670	\$11.97	\$11.37	\$10.77
	PE-C400, PE-B400, PE-B405, LMR-400, LMR-400-DB, LMR-400-UF, .400 inch	PE44672			\$22.37	\$21.25	\$20.13	\$19.24	6
	RG188-DS, RG316-DS	PE45180			\$22.17	\$21.28	\$20.62	\$20.17	7
	RG213, RG8	PE4660			\$21.77	\$20.68	\$19.59	\$18.72	8
	RG214, RG9, RG225, RG393	PE4661			\$25.43	\$24.16	\$22.89	\$21.87	9
	RG55, RG141, RG142, RG223, RG400	PE4663			\$15.11	\$14.35	\$13.60	\$12.99	10
	RG58	PE4664			\$12.82	\$12.18	\$11.54	\$11.03	11
	RG59*, RG62*, RG71	PE4666			\$15.20	\$14.44	\$13.68	\$13.07	12
	RG174, RG316, RG188, LMR-100, PE-B100, PE-C100, .100 inch	PE4668	\$24.11	\$23.15	\$22.42	\$21.94	13		
		Clamp/Solder	RG213, RG55, RG141, RG142, RG223, RG400, RG303, PE-C195, PE-P195, LMR-195	PE4659	\$23.91	\$22.71	\$21.52	\$20.56	14
			RG58, RG55, RG141, RG142, RG223, RG400, RG303, PE-C195, PE-P195, LMR-195	PE4662	\$13.41	\$12.74	\$12.07	\$11.53	15
			RG59*, RG62*, RG71	PE4665	\$14.70	\$13.97	\$13.23	\$12.64	16
			RG174, RG316, RG188	PE4667	\$21.66	\$20.58	\$19.49	\$18.63	17
			RG178, RG196	PE4669	\$19.37	\$18.40	\$17.43	\$16.66	18
PE-SR402AL, PE-SR402FL, RG402			PE4670	\$22.81	\$21.67	\$20.53	\$19.62	19	
PE-SR405AL, PE-SR405FL, RG405			PE4672	\$23.48	\$22.31	\$21.13	\$20.19	20	
PE-B400, PE-B405	PE4674	\$22.31	\$21.19	\$20.08	\$19.19	21			

* Fits MIL-C-17 and equivalent cable versions only

Connectors

See Our Website For Current Pricing & Real-Time Stock Availability!

Reverse Polarity TNC Connectors



Connection Method	Product Image	Attachment Cable/Contact	Coax Type / Termination Type	Model No.	PRICE				ROW
					1-24	25-49	50-99	100 +	
Male									
Cable Connectors		Solder/Solder	PE-SR402AL, PE-SR402FL, RG402	PE4671	\$32.39	\$30.77	\$29.15	\$27.86	22
			PE-SR405AL, PE-SR405FL, RG405	PE4673	\$48.03	\$45.63	\$43.23	\$41.31	23
Male, 4 Hole Flange Mount									
Terminal		Solder	Solder Cup with .531 inch Hole Spacing	PE4708	\$25.05	\$23.80	\$22.55	\$21.54	24
Male Right Angle									
Cable Connectors		Crimp/Solder	RG55, RG141, RG142, RG223, RG400	PE4677	\$24.57	\$23.34	\$22.11	\$21.13	25
			RG58, RG303, RG141, PE-C195, PE-P195, LMR-195, .195 inch	PE4678	\$26.81	\$25.47	\$24.13	\$23.06	26
			RG316, RG174, RG188, LMR-100, PE-B100, PE-C100, .100 inch	PE4681	\$28.96	\$27.51	\$26.06	\$24.91	27
		Clamp/Solder	RG58, RG55, RG141, RG142, RG223, RG400	PE4676	\$34.41	\$32.69	\$30.97	\$29.59	28
			RG59*, RG62*	PE4679	\$29.69	\$28.21	\$26.72	\$25.53	29
			RG316, RG174, RG188	PE4680	\$24.64	\$23.41	\$22.18	\$21.19	30
			RG178, RG196	PE4682	\$27.06	\$25.71	\$24.35	\$23.27	31
Female									
Cable Connectors		Crimp/Solder	PE-C240, RG8X, .240 inch, LMR-240, LMR-240-DB, LMR-240-UF, B7808A	PE44671	\$21.71	\$20.62	\$19.54	\$18.67	32
			PE-C400, PE-B400, PE-B405, LMR-400, LMR-400-DB, LMR-400-UF, .400 inch	PE44673	\$16.93	\$16.08	\$15.24	\$14.56	33
			RG55, RG142, RG223, RG400	PE4685	\$15.91	\$15.11	\$14.32	\$13.68	34
			RG58, RG303, RG141, PE-C195, PE-P195, LMR-195, .195 inch	PE4686	\$17.62	\$16.74	\$15.86	\$15.15	35
			RG59*, RG62*	PE4687	\$19.01	\$18.06	\$17.11	\$16.35	36
			RG316, RG174, RG188, LMR-100, PE-B100, PE-C100, .100 inch	PE4690	\$22.50	\$21.38	\$20.25	\$19.35	37
		Clamp/Solder	RG213, RG8, RG215, RG225, RG214, RG393	PE4683	\$44.00	\$41.80	\$39.60	\$37.84	38
			RG58, RG55, RG141, RG142, RG223, RG400	PE4684	\$19.05	\$18.10	\$17.15	\$16.38	39
			RG59*, RG62*	PE4688	\$22.62	\$21.49	\$20.36	\$19.45	40
			RG316, RG174, RG188	PE4689	\$17.10	\$16.25	\$15.39	\$14.71	41
			RG178, RG196	PE4691	\$17.75	\$16.86	\$15.98	\$15.27	42
			PE-SR402AL, PE-SR402FL, RG402	PE4692	\$22.08	\$20.98	\$19.87	\$18.99	43
				PE-SR405AL, PE-SR405FL, RG405	PE4693	\$22.81	\$21.67	\$20.53	\$19.62
		Crimp/Non-Solder Contact	LMR-200, PE-C200	EZ-200-TFRP	\$17.86	\$17.86	\$17.86	\$17.86	45
Female, Bulkhead Mount									
Cable Connectors		Crimp/Solder	RG174, RG316, RG188, .100 inch, PE-B100, PE-C100, LMR-100	PE44902	\$50.63	\$48.10	\$45.57	\$43.54	46
			RG174, RG316, RG188, .100 inch, PE-B100, PE-C100, LMR-100	PE44903	\$57.87	\$54.98	\$52.08	\$49.77	47
			RG188-DS, RG316-DS with .480 inch D Hole	PE45181	\$23.46	\$22.29	\$21.11	\$20.18	48
			RG55, RG141, RG142, RG223, RG400 with .480 inch D Hole	PE4695	\$20.45	\$19.43	\$18.41	\$17.59	49
			.195 inch, RG58, RG141, RG303, LMR-195, LMR-195-FR, PE-C195, PE-P195 with .480 inch D Hole	PE4696	\$27.51	\$26.13	\$24.76	\$23.66	50
			RG59*, RG62* with .480 inch D Hole	PE4698	\$25.19	\$23.93	\$22.67	\$21.66	51
		Clamp/Solder	.100 inch, RG316, RG174, RG188, LMR-100, LMR-100A, LMR-100A-FR, PE-C100, PE-B100 with .480 inch D Hole	PE4700	\$27.58	\$26.20	\$24.82	\$23.72	52
			RG58, RG142, RG223, RG400, RG141, RG303, RG55, PE-C195, PE-P195 with .480 inch D Hole	PE4694	\$22.76	\$21.62	\$20.48	\$19.57	53
			RG316, RG174, RG188 with .480 inch D Hole	PE4699	\$24.64	\$23.41	\$22.18	\$21.19	54
			RG178, RG196 with .480 inch D Hole	PE4701	\$23.17	\$22.01	\$20.85	\$19.93	55
			PE-SR402AL, PE-SR402FL, RG402 with .480 inch D Hole	PE4702	\$26.79	\$25.45	\$24.11	\$23.04	56
			PE-SR405AL, PE-SR405FL, RG405 with .480 inch D Hole	PE4703	\$27.06	\$25.71	\$24.35	\$23.27	57
Terminal		Solder	Solder Cup with .410 inch D Hole	PE4704	\$19.79	\$18.80	\$17.81	\$17.02	58
			Solder Cup with .350 inch D Hole	PE4706	\$19.79	\$18.80	\$17.81	\$17.02	59
			Solder Cup with .480 inch D Hole	PE4707	\$23.80	\$22.61	\$21.42	\$20.47	60

Connectors









See Our Website For Current Pricing & Real-Time Stock Availability!

* Fits MIL-C-17 and equivalent cable versions only

Reverse Polarity TNC Connectors

Connection Method	Product Image	Attachment Cable/Contact	Coax Type / Termination Type	Model No.	PRICE				ROW
					1-24	25-49	50-99	100 +	
Female, 4 Hole Flange Mount									
Terminal		Solder	Solder Cup with .500 inch Threaded Hole Spacing	PE4705	\$25.72	\$24.43	\$23.15	\$22.12	61
Female Right Angle, Bulkhead Mount									
PCB Mount		Solder	Surface Mount	PE44893	\$70.57	\$67.04	\$63.51	\$60.69	62

UHF Connectors

Connection Method	Product Image	Attachment Cable/Contact	Coax Type / Termination Type	Model No.	PRICE				ROW
					1-24	25-49	50-99	100 +	
Male									
Cable Connectors		Crimp/Solder	RG58, RG303, RG141, PE-C195, PE-P195, LMR-195, .195 inch	PE4069	\$10.65	\$10.12	\$9.59	\$9.16	63
			RG59*, RG62*, RG71	PE4073	\$8.55	\$8.12	\$7.70	\$7.35	64
			RG213, RG215, RG8	PE4295	\$16.49	\$15.67	\$14.84	\$14.18	65
			RG214, RG9, RG225, RG393	PE44051	\$14.42	\$13.70	\$12.98	\$12.40	66
			RG55, RG141, RG142, RG223, RG400	PE44053	\$9.60	\$9.12	\$8.64	\$8.26	67
			PE-B400, PE-B405, PE-C400, LMR-400, .400 inch	PE44054	\$13.34	\$12.67	\$12.01	\$11.47	68
		Clamp/Solder	RG213, RG214, RG8, RG9, RG11*, RG225, RG393, RG144*, RG215, RG216*	PE44050	\$12.80	\$12.16	\$11.52	\$11.01	69
			RG58, RG55, RG141, RG142, RG223, RG400, RG303, PE-C195, PE-P195, LMR-195	PE44052	\$12.37	\$11.75	\$11.13	\$10.64	70
			RG213, RG55, RG141, RG142, RG223, RG400, RG303, PE-C195, PE-P195, LMR-195	PE4020	\$15.51	\$14.73	\$13.96	\$13.34	71
			RG59*, RG62*, RG71	PE44828	\$13.91	\$13.21	\$12.52	\$11.96	72
Female									
Cable Connectors		Crimp/Solder	RG55, RG141, RG142, RG223, RG400	PE44057	\$13.11	\$12.45	\$11.80	\$11.27	73
			RG58, RG303, RG141, PE-C195, PE-P195, LMR-195, .195 inch	PE44058	\$17.05	\$16.20	\$15.35	\$14.66	74
		Clamp/Solder	RG213, RG214, RG8, RG9, RG11*, RG225, RG393, RG144*, RG216*, RG215	PE44055	\$16.17	\$15.36	\$14.55	\$13.91	75
			RG58, RG55, RG141, RG142, RG223, RG400, RG303, PE-C195, PE-P195, LMR-195	PE44056	\$17.05	\$16.20	\$15.35	\$14.66	76
Female, Bulkhead Mount									
Terminal		Solder	Solder Cup with .575 inch D Hole	PE44059	\$12.74	\$12.10	\$11.47	\$10.96	77
			Solder Cup with .575 inch D Hole	PE44060	\$10.96	\$10.41	\$9.86	\$9.43	78
Female, 4 Hole Flange Mount									
Terminal		Solder	Solder Cup with .718 inch Hole Spacing	PE45478	\$9.10	\$8.46	\$7.83	\$7.28	79
		Field Replaceable	Slotted Contact	PE44719	\$55.14	\$52.38	\$49.63	\$47.42	80
Sexless									
Cable Connectors		Accessories	RG59*, RG62*, RG71	PE4021	\$1.87	\$1.78	\$1.68	\$1.61	81
			RG58, RG303, RG141, PE-C195, PE-P195, LMR-195, .195 inch	PE4022	\$2.08	\$1.98	\$1.87	\$1.79	82

UMCX Connectors



Connection Method	Product Image	Attachment Cable/Contact	Coax Type / Termination Type	Model No.	PRICE				ROW
					1-24	25-49	50-99	100 +	
Jack									
PCB Mount		Solder	Surface Mount	PE44594	\$1.80	\$1.71	\$1.62	\$1.55	83

* Fits MIL-C-17 and equivalent cable versions only



Connectors

See Our Website For Current Pricing & Real-Time Stock Availability!







D-Subminiature Connectors

Connection Method	Product Image	Attachment Cable/Contact	Coax Type / Termination Type	Model No.	PRICE				ROW
					1-24	25-49	50-99	100 +	
Plug Right Angle									
Cable Connectors		Solder/Solder	RG55, RG142, RG223, RG400	PE44036	\$13.53	\$12.85	\$12.18	\$11.64	84
Receptacle Right Angle									
Cable Connectors		Solder/Solder	PE-SR405AL, PE-SR405FL, RG405	PE44033	\$14.60	\$14.02	\$13.58	\$13.29	85

75 Ohm 1.0/2.3 Connectors

Connection Method	Product Image	Attachment Cable/Contact	Coax Type / Termination Type	Model No.	PRICE				ROW
					1-24	25-49	50-99	100 +	
Plug									
Cable Connectors		Crimp/Crimp	BELDEN 735A1	PE45227	\$11.15	\$10.59	\$10.04	\$9.59	86
			BELDEN 1855A	PE45228	\$11.15	\$10.59	\$10.04	\$9.59	87
			RG179-DS	PE45233	\$11.15	\$10.59	\$10.04	\$9.59	88
			RG59*	PE45234	\$11.15	\$10.59	\$10.04	\$9.59	89
			RG6-CATV	PE45235	\$16.74	\$15.90	\$15.07	\$14.40	90
Jack, Bulkhead Mount									
PCB Mount		Solder	Thru Hole	PE45229	\$15.23	\$14.47	\$13.71	\$13.10	91
			Thru Hole	PE45231	\$17.02	\$16.17	\$15.32	\$14.64	92
			End Launch	PE45232	\$18.97	\$18.02	\$17.07	\$16.31	93
Jack Right Angle, Bulkhead Mount									
PCB Mount		Solder	Thru Hole	PE45230	\$14.66	\$13.93	\$13.19	\$12.61	94
			Thru Hole	PE45237	\$17.33	\$16.46	\$15.60	\$14.90	95

75 Ohm 1.6/5.6 Connectors











Connection Method	Product Image	Attachment Cable/Contact	Coax Type / Termination Type	Model No.	PRICE				ROW
					1-24	25-49	50-99	100 +	
Plug									
Cable Connectors		Crimp/Solder	RG179, RG187	PE44262	\$17.05	\$16.20	\$15.35	\$14.66	96
			RG59*, RG62*, RG71	PE44263	\$16.17	\$15.36	\$14.55	\$13.91	97
Plug Right Angle									
Cable Connectors		Clamp/Solder	RG179, RG187	PE44264	\$17.28	\$16.42	\$15.55	\$14.86	98
			RG59*	PE44265	\$17.28	\$16.42	\$15.55	\$14.86	99
Jack, Bulkhead Mount									
Cable Connectors		Crimp/Solder	RG179, RG187 with .362 inch DD Hole	PE44266	\$14.82	\$14.08	\$13.34	\$12.75	1
			RG59* with .362 inch DD Hole	PE44267	\$15.74	\$14.95	\$14.17	\$13.54	2
PCB Mount		Solder	Thru Hole with .362 inch Diameter	PE44270	\$15.01	\$14.26	\$13.51	\$12.91	3
Jack Right Angle									
PCB Mount		Solder	Thru Hole with .200 inch x .052 inch Hole Spacing	PE44271	\$17.28	\$16.42	\$15.55	\$14.86	4
Jack Right Angle, Bulkhead Mount									
Cable Connectors		Crimp/Solder	RG179, RG187 with .362 inch DD Hole	PE44268	\$17.28	\$16.42	\$15.55	\$14.86	5

* Fits MIL-C-17 and equivalent cable versions only

Connectors

See Our Website For Current Pricing & Real-Time Stock Availability!

75 Ohm BNC Connectors









Connection Method	Product Image	Attachment Cable/Contact	Coax Type / Termination Type	Model No.	PRICE				ROW	
					1-24	25-49	50-99	100 +		
Male										
Cable Connectors		Crimp/Crimp	RG59*, RG62*, RG71	PE4602	\$10.83	\$10.29	\$9.75	\$9.31	6	
		Crimp/Solder	PE-B159, 1855A, Mini 59	PE44584	\$15.11	\$14.35	\$13.60	\$12.99	7	
			PE-B159, 1855A, Mini 59	PE44625	\$11.76	\$11.17	\$10.58	\$10.11	8	
			1505A	PE44626	\$11.24	\$10.68	\$10.12	\$9.67	9	
			1694A	PE44627	\$5.31	\$5.04	\$4.78	\$4.57	10	
			7731A	PE44628	\$9.73	\$9.24	\$8.76	\$8.37	11	
			1505A	PE44631	\$5.63	\$5.35	\$5.07	\$4.84	12	
			1694A	PE44632	\$15.11	\$14.35	\$13.60	\$12.99	13	
			735A	PE44686	\$27.47	\$26.10	\$24.72	\$23.62	14	
			Belden 1694A	PE45116	\$11.83	\$11.24	\$10.65	\$10.17	15	
			Belden 150A	PE45117	\$8.94	\$8.49	\$8.05	\$7.69	16	
			RG6	PE4598	\$6.84	\$6.50	\$6.16	\$5.88	17	
			RG11*, RG216*, RG144*	PE4600	\$21.58	\$20.50	\$19.42	\$18.56	18	
			RG179, RG187	PE4604	\$13.44	\$12.77	\$12.10	\$11.56	19	
			PE-B150, RG180, RG195	PE4633	\$14.35	\$13.63	\$12.92	\$12.34	20	
	PE-B305	PE4634	\$15.50	\$14.73	\$13.95	\$13.33	21			
		Clamp/Solder	RG6	PE4597	\$24.32	\$23.10	\$21.89	\$20.92	22	
			RG11*, RG144*, RG216*	PE4599	\$34.74	\$33.00	\$31.27	\$29.88	23	
			RG59*, RG62*, RG71	PE4601	\$16.58	\$15.75	\$14.92	\$14.26	24	
			RG179, RG187	PE4603	\$15.30	\$14.54	\$13.77	\$13.16	25	
		Compression	PE-B159, 1855A, Mini 59	PE44577	\$13.67	\$12.99	\$12.30	\$11.76	26	
			Mini 59, PE-B159	PE44578	\$15.84	\$15.05	\$14.26	\$13.62	27	
	Male, Bulkhead Mount									
	Terminal		Solder	Solder Cup with .350 inch D Hole	PE4627	\$21.64	\$20.56	\$19.48	\$18.61	28
	Male, 4 Hole Flange Mount									
	Terminal		Solder	Solder Cup with .531 inch Hole Spacing	PE4625	\$20.13	\$19.12	\$18.12	\$17.31	29
Male Right Angle										
Cable Connectors		Crimp/Solder	RG59*, RG62*, RG71	PE4608	\$30.89	\$29.35	\$27.80	\$26.57	30	
			RG179, RG187	PE4610	\$24.66	\$23.43	\$22.19	\$21.21	31	
		Clamp/Solder	RG6	PE4605	\$36.30	\$34.49	\$32.67	\$31.22	32	
			RG59*, RG62*, RG71	PE4607	\$45.41	\$43.14	\$40.87	\$39.05	33	
			RG179, RG187	PE4609	\$51.23	\$48.67	\$46.11	\$44.06	34	
Female										
Cable Connectors		Crimp/Solder	735A	PE44688	\$26.44	\$25.12	\$23.80	\$22.74	35	
			RG179, RG187	PE4616	\$18.55	\$17.62	\$16.70	\$15.95	36	
		Clamp/Solder	RG6	PE4611	\$45.83	\$43.54	\$41.25	\$39.41	37	
			RG59*	PE4613	\$20.67	\$19.64	\$18.60	\$17.78	38	
			RG179, RG187	PE4615	\$27.69	\$26.58	\$25.75	\$25.20	39	
PCB Mount		Solder	End Launch	PE44619	\$10.31	\$9.79	\$9.28	\$8.87	40	

* Fits MIL-C-17 and equivalent cable versions only

Connectors

See Our Website For Current Pricing & Real-Time Stock Availability!





75 Ohm BNC Connectors

Connection Method	Product Image	Attachment Cable/Contact	Coax Type / Termination Type	Model No.	PRICE				ROW
					1-24	25-49	50-99	100 +	
Female, Bulkhead Mount									
Cable Connectors		Crimp/Solder	PE-B159, 1855A, Mini 59 with .480 inch D Hole	PE44587	\$22.29	\$21.18	\$20.06	\$19.17	41
			735A with .480 inch D Hole	PE44687	\$28.27	\$26.86	\$25.44	\$24.31	42
			RG59*, RG62*, RG71 with .480 inch D Hole	PE4638	\$29.47	\$28.00	\$26.52	\$25.34	43
			RG179, RG187 with .480 inch D Hole	PE4640	\$22.54	\$21.41	\$20.29	\$19.38	44
			PE-B150, RG180, RG195 with .480 inch D Hole	PE4641	\$27.47	\$26.10	\$24.72	\$23.62	45
		Clamp/Solder	PE-B305 with .480 inch D Hole	PE4642	\$31.46	\$29.89	\$28.31	\$27.06	46
			RG6 with .480 inch D Hole	PE4635	\$50.82	\$48.28	\$45.74	\$43.71	47
			RG59*, RG62*, RG71 with .480 inch D Hole	PE4637	\$35.38	\$33.61	\$31.84	\$30.43	48
			RG179, RG187 with .480 inch D Hole	PE4639	\$33.75	\$32.40	\$31.39	\$30.71	49
PCB Mount		Solder	End Launch with .500 inch Diameter	PE44620	\$16.89	\$16.05	\$15.20	\$14.53	50
Terminal			Solder Cup with .410 inch D Hole	PE4619	\$10.57	\$10.04	\$9.51	\$9.09	51
		Solder Cup with .350 inch D Hole	PE4620	\$14.80	\$14.06	\$13.32	\$12.73	52	
		Turret with .480 inch D Hole	PE4621	\$44.64	\$42.41	\$40.18	\$38.39	53	
		Turret with .350 inch D Hole	PE4624	\$36.27	\$34.46	\$32.64	\$31.19	54	
		Solder Cup with .350 inch D Hole	PE4626	\$12.84	\$12.20	\$11.56	\$11.04	55	
Female, 4 Hole Flange Mount									
Cable Connectors		Clamp/Solder	RG179, RG187 with .500 inch Threaded Hole Spacing	PE44652	\$34.70	\$32.97	\$31.23	\$29.84	56
			RG59*, RG62*, RG71 with .500 inch Threaded Hole Spacing	PE4623	\$36.20	\$34.39	\$32.58	\$31.13	57
Terminal		Solder	Solder Cup with .500 inch Threaded Hole Spacing	PE4617	\$15.79	\$15.00	\$14.21	\$13.58	58
			Turret with .531 inch Hole Spacing	PE4618	\$44.11	\$41.90	\$39.70	\$37.93	59
			Solder Cup with .500 inch Hole Spacing	PE4630	\$19.79	\$18.80	\$17.81	\$17.02	60
			Solder Cup with .718 inch Hole Spacing	PE4631	\$27.35	\$25.98	\$24.62	\$23.52	61
Female Right Angle, Bulkhead Mount									
Terminal		Solder	Solder Cup with .361 inch D Hole	PE4622	\$54.99	\$52.24	\$49.49	\$47.29	62
Female Right Angle, 4 Hole Flange Mount									
Terminal		Solder	Solder Cup with .531 inch Hole Spacing	PE4628	\$25.79	\$24.50	\$23.21	\$22.18	63

Connectors











See Our Website For Current Pricing & Real-Time Stock Availability!

75 Ohm F Connectors



Connection Method	Product Image	Attachment Cable/Contact	Coax Type / Termination Type	Model No.	PRICE				ROW
					1-24	25-49	50-99	100 +	
Male									
Cable Connectors		Crimp/Crimp	RG6	PE44312	\$2.24	\$2.13	\$2.02	\$1.93	64
			RG59*, RG62*, RG71	PE44317	\$5.28	\$5.02	\$4.75	\$4.54	65
		Crimp/Solder	RG6-CATV	PE44313	\$5.23	\$4.97	\$4.71	\$4.50	66
			RG11*, RG216*, RG144*	PE44315	\$6.52	\$6.19	\$5.87	\$5.61	67
			RG59*, RG62*, RG71	PE44316	\$1.37	\$1.30	\$1.23	\$1.18	68
			RG6-CATV	PE44452	\$2.68	\$2.55	\$2.41	\$2.30	69
			PE-B159, 1855A, Mini 59	PE44582	\$5.61	\$5.33	\$5.05	\$4.82	70
		Compression	RG179, RG187	PE45520	\$3.85	\$3.66	\$3.47	\$3.31	71
			PE-B159, 1855A, Mini 59	PE44572	\$6.25	\$5.94	\$5.63	\$5.38	72
			PE-B159, 1855A, Mini 59	PE44573	\$5.44	\$5.17	\$4.90	\$4.68	73
		Twist	RG6	PE44314	\$2.46	\$2.34	\$2.21	\$2.12	74
			RG59*, RG62*, RG71	PE44318	\$1.58	\$1.50	\$1.42	\$1.36	75
		Crimp/Non-Solder Contact	LMR-400-75	EZ-400-FM-75	\$27.50	\$27.50	\$27.50	\$27.50	76

* Fits MIL-C-17 and equivalent cable versions only

75 Ohm F Connectors

Connection Method	Product Image	Attachment Cable/Contact	Coax Type / Termination Type	Model No.	PRICE				ROW
					1-24	25-49	50-99	100 +	
Male Right Angle									
Cable Connectors		Crimp/Solder	RG6-CATV	PE44320	\$9.34	\$8.87	\$8.41	\$8.03	77
			RG59*, RG62*, RG71	PE44322	\$7.60	\$7.22	\$6.84	\$6.54	78
		Compression	PE-B159, 1855A, Mini 59	PE44579	\$12.88	\$12.24	\$11.59	\$11.08	79
		Twist	RG59*, RG62*, RG71	PE44323	\$5.80	\$5.51	\$5.22	\$4.99	80
Female									
PCB Mount		Solder	Thru Hole with .320 inch x .091 inch Hole Spacing	PE44331	\$2.15	\$2.04	\$1.94	\$1.85	81
Female, Bulkhead Mount									
Cable Connectors		Crimp/Solder	RG6-CATV	PE44324	\$8.42	\$8.00	\$7.58	\$7.24	82
			PE-B159, 1855A, Mini 59 with .480 inch D Hole	PE44585	\$6.94	\$6.59	\$6.25	\$5.97	83
			RG179, RG187 with .380 inch DD Hole	PE45504	\$6.49	\$6.23	\$6.04	\$5.91	84
			RG59*, RG62*, RG71	PE45552	\$5.04	\$4.79	\$4.54	\$4.33	85
Terminal		Solder	Tab with .380 inch DD Hole	PE44327	\$1.64	\$1.56	\$1.48	\$1.41	86
PCB Mount			Thru Hole with .340 inch x .091 inch Hole Spacing	PE44332	\$5.58	\$5.30	\$5.02	\$4.80	87
Female, 4 Hole Flange Mount									
Terminal		Solder	Pin with .500 inch Hole Spacing	PE44329	\$9.40	\$8.93	\$8.46	\$8.08	88
Female, Thread-In									
Terminal		Solder	Pin with .380 inch Diameter	PE44330	\$2.58	\$2.45	\$2.32	\$2.22	89
Female Right Angle									
PCB Mount		Solder	Thru Hole with .320 inch x .091 inch Hole Spacing	PE44333	\$6.68	\$6.35	\$6.01	\$5.74	90
Female Right Angle, Bulkhead Mount									
PCB Mount		Solder	Thru Hole with .350 inch D Hole	PE44334	\$8.17	\$7.76	\$7.35	\$7.03	91
			Surface Mount	PE44895	\$14.69	\$13.96	\$13.22	\$12.63	92

75 Ohm MCX Connectors





Connection Method	Product Image	Attachment Cable/Contact	Coax Type / Termination Type	Model No.	PRICE				ROW
					1-24	25-49	50-99	100 +	
Plug									
Cable Connectors		Crimp/Solder	RG179, RG187	PE44298	\$14.02	\$13.32	\$12.62	\$12.06	93
PCB Mount		Solder	Thru Hole with .200 inch x .055 inch Hole Spacing	PE44307	\$19.62	\$18.64	\$17.66	\$16.87	94

* Fits MIL-C-17 and equivalent cable versions only







Connectors

See Our Website For Current Pricing & Real-Time Stock Availability!

75 Ohm MCX Connectors

Connection Method	Product Image	Attachment Cable/Contact	Coax Type / Termination Type	Model No.	PRICE				ROW
					1-24	25-49	50-99	100 +	
Plug Right Angle									
Cable Connectors		Crimp/Solder	RG179, RG187	PE45086	\$17.13	\$16.27	\$15.42	\$14.73	95
Jack									
Cable Connectors		Crimp/Solder	RG179, RG187	PE44300	\$26.34	\$25.02	\$23.71	\$22.65	96
PCB Mount		Solder	.072 inch End Launch	PE45211	\$12.05	\$11.45	\$10.85	\$10.36	97
Jack Right Angle									
PCB Mount		Solder	Thru Hole with .200 inch x .055 inch Hole Spacing	PE44304	\$17.29	\$16.43	\$15.56	\$14.87	98

75 Ohm Mini SMB Connectors









Connection Method	Product Image	Attachment Cable/Contact	Coax Type / Termination Type	Model No.	PRICE				ROW
					1-24	25-49	50-99	100 +	
Plug									
Cable Connectors		Crimp/Solder	PE-B159, 1855A, Mini 59	PE44588	\$21.76	\$20.67	\$19.58	\$18.71	99
			RG179, RG187	PE4993	\$17.63	\$16.75	\$15.87	\$15.16	1
			RG59*, RG62*, RG71	PE4994	\$28.80	\$27.65	\$26.78	\$26.21	2
Plug Right Angle									
Cable Connectors		Crimp/Solder	RG179, RG187	PE4995	\$20.84	\$19.80	\$18.76	\$17.92	3
			RG59*, RG62*, RG71	PE4996	\$25.64	\$24.36	\$23.08	\$22.05	4
Jack									
Cable Connectors		Crimp/Solder	Mini 59, PE-B159	PE44590	\$26.57	\$25.24	\$23.91	\$22.85	5
PCB Mount		Solder	.062 inch End Launch	PE44131	\$24.82	\$23.58	\$22.34	\$21.35	6
			.042 inch End Launch	PE44134	\$19.62	\$18.64	\$17.66	\$16.87	7
			Thru Hole with .200 inch x .055 inch Hole Spacing	PE4997	\$16.80	\$15.96	\$15.12	\$14.45	8
Jack, Bulkhead Mount									
PCB Mount		Solder	Thru Hole with .177 inch D Hole	PE44125	\$53.94	\$51.24	\$48.55	\$46.39	9
Jack, 2 Hole Flange Mount									
Terminal		Solder	Solder Cup with .328 inch Hole Spacing	PE44141	\$23.79	\$22.60	\$21.41	\$20.46	10
Jack Right Angle									
PCB Mount		Solder	Thru Hole with .200 inch x .055 inch Hole Spacing	PE4998	\$23.91	\$22.71	\$21.52	\$20.56	11
Jack Right Angle, Bulkhead Mount									
PCB Mount		Solder	Thru Hole with .177 inch D Hole	PE44128	\$25.16	\$23.90	\$22.64	\$21.64	12

Connectors





See Our Website For Current Pricing & Real-Time Stock Availability!

* Fits MIL-C-17 and equivalent cable versions only

75 Ohm N Connectors

Connection Method	Product Image	Attachment Cable/Contact	Coax Type / Termination Type	Model No.	PRICE				ROW
					1-24	25-49	50-99	100 +	
Male									
Cable Connectors		Crimp/Solder	RG6	PE4508	\$23.89	\$22.70	\$21.50	\$20.55	13
			RG11*, RG144*, RG216*	PE4510	\$24.34	\$23.12	\$21.91	\$20.93	14
			RG59*, RG62*, RG71	PE4512	\$24.11	\$22.90	\$21.70	\$20.73	15
			RG179, RG187	PE4656	\$37.33	\$35.46	\$33.60	\$32.10	16
		Clamp/Solder	RG6	PE4507	\$22.60	\$21.47	\$20.34	\$19.44	17
			RG11*, RG144*, RG216*	PE4509	\$35.78	\$34.35	\$33.28	\$32.56	18
			RG59*, RG62*, RG71	PE4511	\$23.01	\$21.86	\$20.71	\$19.79	19
			RG179, RG187	PE4513	\$20.50	\$19.48	\$18.45	\$17.63	20
		Crimp/Non-Solder Contact	LMR-400-75	EZ-400-NMH-75-X	\$36.99	\$36.99	\$36.99	\$36.99	21
	Male, 4 Hole Flange Mount								
Terminal		Solder	Solder Cup with .718 inch Hole Spacing	PE4504	\$24.82	\$23.58	\$22.34	\$21.35	22
Male Right Angle									
Cable Connectors		Clamp/Solder	RG11*, RG144*, RG216*	PE4502	\$52.70	\$50.59	\$49.01	\$47.96	23
Female									
Cable Connectors		Clamp/Solder	RG6	PE4514	\$43.14	\$41.41	\$40.12	\$39.26	24
			RG11*, RG144*, RG216* with .480 inch D Hole	PE4515	\$33.35	\$31.68	\$30.02	\$28.68	25
			RG59*, RG62*, RG71	PE4516	\$36.86	\$35.02	\$33.17	\$31.70	26
Female, Bulkhead Mount									
Terminal		Solder	Solder Cup with .640 inch DD Hole	PE4505	\$28.17	\$26.76	\$25.35	\$24.23	27
			Solder Cup with .380 inch Diameter	PE4506	\$18.13	\$17.22	\$16.32	\$15.59	28
Female, 4 Hole Flange Mount									
Terminal		Solder	Solder Cup with .718 inch Hole Spacing	PE4503	\$16.98	\$16.13	\$15.28	\$14.60	29

75 Ohm RCA Connectors















Connection Method	Product Image	Attachment Cable/Contact	Coax Type / Termination Type	Model No.	PRICE				ROW
					1-24	25-49	50-99	100 +	
Male									
Cable Connectors		Crimp/Solder	PE-B159	PE44583	\$13.56	\$12.88	\$12.20	\$11.66	30
			Mini 59, PE-B159	PE44622	\$14.35	\$13.63	\$12.92	\$12.34	31
			1694A	PE44623	\$11.71	\$11.12	\$10.54	\$10.07	32
			1505A	PE44624	\$14.35	\$13.63	\$12.92	\$12.34	33
		Compression	PE-B159, 1855A, Mini 59	PE44574	\$12.67	\$12.04	\$11.40	\$10.90	34
			Mini 59, PE-B159	PE44576	\$6.68	\$6.35	\$6.01	\$5.74	35
Male Right Angle									
Cable Connectors		Compression	Mini 59, PE-B159	PE44580	\$17.28	\$16.42	\$15.55	\$14.86	36
Female, Bulkhead Mount									
Cable Connectors		Crimp/Solder	PE-B159, 1855A, Mini 59 with .480 inch D Hole	PE44586	\$17.43	\$16.56	\$15.69	\$14.99	37

* Fits MIL-C-17 and equivalent cable versions only

Connectors

See Our Website For Current Pricing & Real-Time Stock Availability!

75 Ohm SMB Connectors



Connection Method	Product Image	Attachment Cable/Contact	Coax Type / Termination Type	Model No.	PRICE				ROW
					1-24	25-49	50-99	100 +	
Plug									
Cable Connectors		Crimp/Solder	PE-B150, RG180, RG195	PE4157	\$25.70	\$24.42	\$23.13	\$22.10	38
			RG179, RG187	PE4248	\$19.74	\$18.75	\$17.77	\$16.98	39
			RG59*, RG62*, RG71	PE4472	\$24.32	\$23.10	\$21.89	\$20.92	40
		Clamp/Solder	RG59*, RG62*, RG71	PE4203	\$18.94	\$17.99	\$17.05	\$16.29	41
			RG179, RG187	PE4257	\$24.97	\$23.72	\$22.47	\$21.47	42
PCB Mount		Solder	Thru Hole with .200 inch x .067 inch Hole Spacing	PE4368	\$19.06	\$18.30	\$17.73	\$17.34	43
Plug, Bulkhead Mount									
Terminal		Solder	Solder Cup with .295 inch D Hole	PE4290	\$62.19	\$59.08	\$55.97	\$53.48	44
Plug Right Angle									
Cable Connectors		Crimp/Solder	PE-B150, RG180, RG195	PE4161	\$47.87	\$45.96	\$44.52	\$43.56	45
			RG179, RG187	PE4251	\$27.25	\$25.89	\$24.53	\$23.44	46
		Clamp/Solder	RG59*, RG62*	PE4264	\$39.25	\$37.29	\$35.33	\$33.76	47
			RG180, RG195	PE4265	\$21.57	\$20.49	\$19.41	\$18.55	48
PCB Mount		Solder	Thru Hole with .200 inch x .067 inch Hole Spacing	PE4292	\$49.42	\$46.95	\$44.48	\$42.50	49
Jack									
Cable Connectors		Crimp/Solder	PE-B150, RG180, RG195	PE4163	\$20.46	\$19.44	\$18.41	\$17.60	50
			RG179, RG187	PE44872	\$35.28	\$33.52	\$31.75	\$30.34	51
		Clamp/Solder	RG59*, RG62*	PE4272	\$33.86	\$32.17	\$30.47	\$29.12	52
			RG180, RG195	PE4273	\$43.13	\$40.97	\$38.82	\$37.09	53
PCB Mount		Solder	RG179, RG187	PE4928	\$44.04	\$41.84	\$39.64	\$37.87	54
			Thru Hole with .200 inch x .067 inch Hole Spacing	PE4110	\$22.06	\$20.96	\$19.85	\$18.97	55
Jack, Bulkhead Mount									
Cable Connectors		Crimp/Solder	RG179, RG187 with .285 inch D Hole	PE4255	\$47.13	\$44.77	\$42.42	\$40.53	56
		Clamp/Solder	RG59*, RG62* with .177 inch D Hole	PE4280	\$43.38	\$41.21	\$39.04	\$37.31	57
			RG180, RG195 with .285 inch D Hole	PE4281	\$26.81	\$25.47	\$24.13	\$23.06	58
Terminal		Solder	Solder Cup with .317 inch Diameter	PE4168	\$16.35	\$15.53	\$14.72	\$14.06	59
			Solder Cup with .295 inch D Hole	PE4172	\$17.16	\$16.30	\$15.44	\$14.76	60
Jack Right Angle									
PCB Mount		Solder	Thru Hole with .200 inch x .067 inch Hole Spacing	PE4179	\$23.91	\$22.71	\$21.52	\$20.56	61
Jack Right Angle, Bulkhead Mount									
Terminal		Solder	Solder Cup with .295 inch D Hole	PE4286	\$60.51	\$57.48	\$54.46	\$52.04	62

Connectors













See Our Website For Current Pricing & Real-Time Stock Availability!

* Fits MIL-C-17 and equivalent cable versions only

75 Ohm SMB Positive Snap Connectors

Connection Method	Product Image	Attachment Cable/Contact	Coax Type / Termination Type	Model No.	PRICE				ROW
					1-24	25-49	50-99	100 +	
Plug									
Cable Connectors		Crimp/Solder	RG59*, RG62*	PE44442	\$21.57	\$20.49	\$19.41	\$18.55	63
			RG179, RG187	PE44443	\$31.35	\$29.78	\$28.22	\$26.96	64
Plug Right Angle									
Cable Connectors		Crimp/Solder	RG179, RG187	PE44445	\$34.48	\$32.76	\$31.03	\$29.65	65
			RG180, RG195	PE44446	\$47.43	\$45.06	\$42.69	\$40.79	66

75 Ohm SMC Connectors

Connection Method	Product Image	Attachment Cable/Contact	Coax Type / Termination Type	Model No.	PRICE				ROW
					1-24	25-49	50-99	100 +	
Plug									
Cable Connectors		Crimp/Solder	PE-B150, RG180, RG195	PE4158	\$26.36	\$25.04	\$23.72	\$22.67	67
			RG179, RG187	PE4249	\$21.26	\$20.20	\$19.13	\$18.28	68
		Clamp/Solder	RG59*, RG62*, RG71	PE4658	\$27.40	\$26.03	\$24.66	\$23.56	69
			RG59*, RG62*, RG71	PE4258	\$46.88	\$44.54	\$42.19	\$40.32	70
			RG179, RG187	PE4259	\$44.04	\$41.84	\$39.64	\$37.87	71
Plug, Bulkhead Mount									
Terminal		Solder	Solder Cup with .295 inch D Hole	PE4291	\$45.36	\$43.09	\$40.82	\$39.01	72
Plug Right Angle									
Cable Connectors		Crimp/Solder	RG180, RG195	PE4162	\$36.57	\$34.74	\$32.91	\$31.45	73
			RG179, RG187	PE4252	\$33.31	\$31.64	\$29.98	\$28.65	74
			Clamp/Solder	RG59*, RG62*	PE4266	\$30.17	\$28.66	\$27.15	\$25.95
PCB Mount		Solder	Thru Hole with .200 inch x .067 inch Hole Spacing	PE4293	\$45.00	\$42.75	\$40.50	\$38.70	76
Jack									
Cable Connectors		Crimp/Solder	RG180, RG195	PE4164	\$29.54	\$28.36	\$27.47	\$26.88	77
			RG179, RG187	PE4254	\$38.64	\$37.09	\$35.94	\$35.16	78
		Clamp/Solder	RG59*, RG62*	PE4274	\$38.37	\$36.45	\$34.53	\$33.00	79
			RG180, RG195	PE4275	\$32.20	\$30.59	\$28.98	\$27.69	80
PCB Mount		Solder	Thru Hole with .200 inch x .067 inch Hole Spacing	PE4176	\$20.29	\$19.48	\$18.87	\$18.46	81
Jack, Bulkhead Mount									
Cable Connectors		Crimp/Solder	RG179, RG187 with .285 inch D Hole	PE4256	\$34.14	\$32.43	\$30.73	\$29.36	82
			RG180, RG195 with .285 inch D Hole	PE4283	\$28.69	\$27.26	\$25.82	\$24.67	83
			Clamp/Solder	RG179, RG187	PE4906	\$41.25	\$39.19	\$37.13	\$35.48
Terminal		Solder	Solder Cup with .295 inch D Hole	PE4169	\$45.05	\$42.80	\$40.55	\$38.74	85
			Solder Cup with .295 inch D Hole	PE4173	\$31.47	\$29.90	\$28.32	\$27.06	86

* Fits MIL-C-17 and equivalent cable versions only







Connectors

See Our Website For Current Pricing & Real-Time Stock Availability!



75 Ohm SMC Connectors

Connection Method	Product Image	Attachment Cable/Contact	Coax Type / Termination Type	Model No.	PRICE				ROW
					1-24	25-49	50-99	100 +	
Jack Right Angle									
PCB Mount		Solder	Thru Hole with .200 inch x .067 inch Hole Spacing	PE4180	\$39.79	\$37.80	\$35.81	\$34.22	87

75 Ohm TNC Connectors





Connection Method	Product Image	Attachment Cable/Contact	Coax Type / Termination Type	Model No.	PRICE				ROW
					1-24	25-49	50-99	100 +	
Male									
Cable Connectors		Crimp/Solder	RG6	PE44162	\$20.67	\$19.64	\$18.60	\$17.78	88
			RG11*, RG144*	PE44164	\$42.14	\$40.03	\$37.93	\$36.24	89
			RG59*, RG62*	PE44166	\$17.89	\$17.00	\$16.10	\$15.39	90
			RG179, RG187	PE44168	\$18.22	\$17.31	\$16.40	\$15.67	91
		Clamp/Solder	RG6	PE44161	\$26.00	\$24.96	\$24.18	\$23.66	92
			RG11*, RG144*, RG216*	PE44163	\$58.56	\$55.63	\$52.70	\$50.36	93
			RG59*	PE44165	\$17.89	\$17.00	\$16.10	\$15.39	94
			RG179, RG187	PE44167	\$17.89	\$17.00	\$16.10	\$15.39	95
Male Right Angle									
Cable Connectors		Clamp/Solder	RG59*, RG62*, RG71	PE44171	\$57.69	\$54.81	\$51.92	\$49.61	96
			RG179, RG187	PE44172	\$54.94	\$52.19	\$49.45	\$47.25	97
Female, Bulkhead Mount									
Cable Connectors		Clamp/Solder	RG6 with .480 inch D Hole	PE44173	\$43.53	\$41.35	\$39.18	\$37.44	98
			RG11*, RG216* with .480 inch D Hole	PE44174	\$45.56	\$43.28	\$41.00	\$39.18	99
			RG59*, RG62*, RG71 with .480 inch D Hole	PE44175	\$51.35	\$48.78	\$46.22	\$44.16	1
			RG179, RG187 with .480 inch D Hole	PE44176	\$46.61	\$44.28	\$41.95	\$40.08	2
Terminal		Solder	Solder Cup with .410 inch D Hole	PE44177	\$21.26	\$20.20	\$19.13	\$18.28	3
			Solder Cup with .480 inch D Hole	PE44181	\$27.37	\$26.00	\$24.63	\$23.54	4
Female, 4 Hole Flange Mount									
Terminal		Solder	Solder Cup with .500 inch Threaded Hole Spacing	PE44178	\$19.79	\$18.80	\$17.81	\$17.02	5

BNC Twinax Connectors





Connection Method	Product Image	Attachment Cable/Contact	Coax Type / Termination Type	Model No.	PRICE				ROW
					1-24	25-49	50-99	100 +	
Plug									
Cable Connectors		Crimp/Solder	RG108, 78 Ohm Twinax	PE4234	\$21.30	\$20.24	\$19.17	\$18.32	6
		Clamp/Solder	RG108, 78 Ohm Twinax	PE4236	\$28.16	\$26.75	\$25.34	\$24.22	7
Jack									
Cable Connectors		Crimp/Solder	RG108, 78 Ohm Twinax	PE4235	\$40.64	\$38.61	\$36.58	\$34.95	8
		Clamp/Solder	RG108, 78 Ohm Twinax	PE4237	\$35.24	\$33.48	\$31.72	\$30.31	9
PCB Mount		Solder	Thru Hole with .687 inch x .500 inch Hole Spacing	PE44115	\$31.73	\$30.46	\$29.51	\$28.87	10

* Fits MIL-C-17 and equivalent cable versions only

BNC Twinax Connectors

Connection Method	Product Image	Attachment Cable/Contact	Coax Type / Termination Type	Model No.	PRICE				ROW
					1-24	25-49	50-99	100 +	
Jack, Bulkhead Mount									
Cable Connectors		Clamp/Solder	RG108, 78 Ohm Twinax with .480 inch D Hole	PE44114	\$48.96	\$46.51	\$44.06	\$42.11	11
Terminal		Solder	Solder Cup with .350 inch D Hole	PE4238	\$19.91	\$18.91	\$17.92	\$17.12	12
Jack, 4 Hole Flange Mount									
Terminal		Solder	Solder Cup with .500 inch Threaded Hole Spacing	PE4324	\$33.39	\$31.72	\$30.05	\$28.72	13
Jack Right Angle									
PCB Mount		Solder	Thru Hole with .687 inch x .500 inch Hole Spacing	PE44116	\$48.75	\$46.31	\$43.88	\$41.93	14

3/4" -20 Twinax Connectors

Connection Method	Product Image	Attachment Cable/Contact	Coax Type / Termination Type	Model No.	PRICE				ROW
					1-24	25-49	50-99	100 +	
Male									
Cable Connectors		Clamp/Solder	PE-S330	PE4104	\$24.87	\$23.63	\$22.38	\$21.39	15
Female									
Cable Connectors		Clamp/Solder	PE-S330	PE4346	\$25.82	\$24.53	\$23.24	\$22.21	16
Female, Bulkhead Mount									
Terminal		Solder	Solder Cup with .720 inch D Hole	PE4105	\$26.83	\$25.49	\$24.15	\$23.07	17
Female, 4 Hole Flange Mount									
Terminal		Solder	Solder Cup with .718 inch Hole Spacing	PE4347	\$31.90	\$30.31	\$28.71	\$27.43	18

Banana Connectors

Connection Method	Product Image	Attachment Cable/Contact	Coax Type / Termination Type	Model No.	PRICE				ROW
					1-24	25-49	50-99	100 +	
Plug									
Cable Connectors		Crimp/Solder	RG188-DS, RG316-DS	PE45164	\$14.70	\$13.97	\$13.23	\$12.64	19
			RG65, RG142, RG223, RG400	PE4089	\$9.96	\$9.46	\$8.96	\$8.57	20

Double Banana Connectors

Connection Method	Product Image	Attachment Cable/Contact	Coax Type / Termination Type	Model No.	PRICE				ROW
					1-24	25-49	50-99	100 +	
Plug									
Cable Connectors		Crimp/Solder	RG174, RG316, RG188, .100 inch, PE-B100, PE-C100, LMR-100	PE44145	\$13.59	\$12.91	\$12.23	\$11.69	21
			PE-C195, PE-P195, RG58, RG141, RG303, LMR-195, .195 inch	PE4301	\$10.44	\$9.92	\$9.40	\$8.98	22

* Fits MIL-C-17 and equivalent cable versions only

CONNECTOR DUST CAPS

Non-Shorting Caps



Connector	Gender	Compatible With	Chain	Model No	1-24	25-49	50-99	100+	R O W	
7/16 DIN	Male	50 Ohm	Yes	PE6057	\$43.25	\$41.09	\$38.93	\$37.20	1	
	Female		Yes	PE6058	\$53.20	\$50.54	\$47.88	\$45.75	2	
BNC	Male		Yes	PE6013	\$8.90	\$8.46	\$8.01	\$7.65	3	
			No	PE6014	\$4.98	\$4.73	\$4.48	\$4.28	4	
	Female		Yes	PE6015	\$7.26	\$6.90	\$6.53	\$6.24	5	
			No	PE6108	\$10.68	\$10.15	\$9.61	\$9.18	6	
C	Male		Yes	PE6046	\$22.52	\$21.39	\$20.27	\$19.37	7	
			No	PE6109	\$28.89	\$27.45	\$26.00	\$24.85	8	
	Female		Yes	PE6110	\$28.93	\$27.48	\$26.04	\$24.88	9	
			No	PE6111	\$21.69	\$20.61	\$19.52	\$18.65	10	
F	50 Ohm		No	PE6240	\$3.61	\$3.43	\$3.25	\$3.10	11	
HN			Male	Yes	PE6059	\$29.39	\$27.92	\$26.45	\$25.28	12
				No	PE6113	\$21.01	\$19.96	\$18.91	\$18.07	13
			Female	Yes	PE6114	\$28.78	\$27.34	\$25.90	\$24.75	14
		No		PE6115	\$29.36	\$27.89	\$26.42	\$25.25	15	
N		Male	Yes	PE6016	\$7.36	\$6.99	\$6.62	\$6.33	16	
			No	PE6017	\$8.00	\$7.60	\$7.20	\$6.88	17	
		Female	Yes	PE6018	\$11.30	\$10.74	\$10.17	\$9.72	18	
			No	PE6116	\$9.77	\$9.28	\$8.79	\$8.40	19	
SC		Male	Yes	PE6117	\$42.14	\$40.03	\$37.93	\$36.24	20	
			Female	Yes	PE6118	\$33.06	\$31.41	\$29.75	\$28.43	21
		Female	Yes	PE6019	\$11.79	\$11.20	\$10.61	\$10.14	22	
			No	PE6024	\$3.83	\$3.64	\$3.45	\$3.29	23	
SMA		Male	Yes	PE6119	\$23.42	\$22.25	\$21.08	\$20.14	24	
	No		PE6120	\$9.25	\$8.79	\$8.33	\$7.96	25		
	Female	Yes	PE6121	\$24.90	\$23.66	\$22.41	\$21.41	26		
		Yes	PE6125	\$39.16	\$37.20	\$35.24	\$33.68	27		
SMB	Plug	75 Ohm	Yes	PE6122	\$20.82	\$19.78	\$18.74	\$17.91	28	
		50 Ohm	Yes	PE6123	\$17.87	\$16.98	\$16.08	\$15.37	29	
	Jack	75 Ohm	Yes	PE6126	\$36.02	\$34.22	\$32.42	\$30.98	30	
		50 Ohm	Yes	PE6124	\$16.24	\$15.43	\$14.62	\$13.97	31	
SSMA	Male	50 Ohm	No	PE6020	\$16.84	\$16.00	\$15.16	\$14.48	32	
			Yes	PE6023	\$10.27	\$9.76	\$9.24	\$8.83	33	
			No	PE6144	\$9.40	\$8.93	\$8.46	\$8.08	34	
			Yes	PE6021	\$12.55	\$11.92	\$11.30	\$10.79	35	
TNC	Female	50 Ohm	No	PE6143	\$12.09	\$11.49	\$10.88	\$10.40	36	

Shorting Caps



Connector	Gender	Compatible With	Chain	Model No	1-24	25-49	50-99	100+	R O W
2.4mm	Male	50 Ohm	Yes	PE6194	\$62.86	\$60.35	\$58.46	\$57.20	37
	Female		Yes	PE6195	\$75.70	\$71.92	\$68.13	\$65.10	38
BNC	Male		No	PE6193	\$68.64	\$65.21	\$61.78	\$59.03	39
			Yes	PE6127	\$23.67	\$22.49	\$21.30	\$20.36	40
	Female		No	PE6012	\$7.88	\$7.49	\$7.09	\$6.78	41
			Yes	PE6128	\$25.68	\$24.40	\$23.11	\$22.08	42
N	Male		No	PE6030	\$15.15	\$14.39	\$13.64	\$13.03	43
			Yes	PE6129	\$30.31	\$28.79	\$27.28	\$26.07	44
	Female		No	PE6022	\$21.93	\$20.83	\$19.74	\$18.86	45
			Yes	PE6130	\$48.43	\$46.01	\$43.59	\$41.65	46
SMA	Male		No	PE6031	\$10.78	\$10.24	\$9.70	\$9.27	47
			Yes	PE6131	\$29.62	\$28.14	\$26.66	\$25.47	48
	Female		No	PE6006	\$22.63	\$21.50	\$20.37	\$19.46	49
			Yes	PE6132	\$34.03	\$32.33	\$30.63	\$29.27	50
TNC	Male	Yes	PE6251	\$24.40	\$23.42	\$22.69	\$22.20	51	
		No	PE6007	\$25.05	\$23.80	\$22.55	\$21.54	52	
	Female	No	PE6133	\$23.87	\$22.68	\$21.48	\$20.53	53	
		Yes	PE6136	\$30.63	\$29.10	\$27.57	\$26.34	54	
		No	PE6135	\$22.55	\$21.42	\$20.30	\$19.39	55	

* Fits MIL-C-17 and equivalent cable versions only

Connectors

See Our Website For Current Pricing & Real-Time Stock Availability!

COUPLERS AND HYBRIDS

Single Directional

1.85mm Connectors



Frequency Range (MHz.)	Coupling (dB)	Maximum Power	Directivity (dB)	Model No	1	2-4	5-9	10+	ROW
1,000-67,000	10	20 Watt	8	PE2CP1127-10	\$5,999.00	\$5,759.04	\$5,519.08	\$5,279.12	1
	20			PE2CP1127-20	\$5,999.00	\$5,759.04	\$5,519.08	\$5,279.12	

2.4mm Connectors



Frequency Range (MHz.)	Coupling (dB)	Maximum Power	Directivity (dB)	Model No	1	2-4	5-9	10+	ROW
2,000-52,000	10	20 Watt	10	PE2CP1134-10	\$3,200.00	\$3,072.00	\$2,944.00	\$2,816.00	2
18,000-50,000	20		8	PE2CP1135-20	\$3,082.37	\$2,959.08	\$2,835.78	\$2,712.49	3

2.92mm Connectors



Frequency Range (MHz.)	Coupling (dB)	Maximum Power	Directivity (dB)	Model No	1	2-4	5-9	10+	ROW
1,000-40,000	20	30 Watt	10	PE2CP1122-20	\$2,076.96	\$1,993.88	\$1,910.80	\$1,827.72	4
	30			PE2CP1122-30	\$2,076.96	\$1,993.88	\$1,910.80	\$1,827.72	
2,000-40,000	20			PE2CP1133-20	\$1,699.00	\$1,631.04	\$1,563.08	\$1,495.12	5
	30			PE2CP1133-30	\$1,765.26	\$1,694.65	\$1,624.04	\$1,553.43	
6,000-40,000	20		PE2CP1124-20	\$1,599.00	\$1,535.04	\$1,471.08	\$1,407.12	6	
8,000-40,000			PE2CP1125-20	\$1,566.67	\$1,504.00	\$1,441.34	\$1,378.67	7	
18,000-40,000	30		PE2CP1125-30	\$1,566.67	\$1,504.00	\$1,441.34	\$1,378.67	8	
	6		PE2CP1126-6	\$1,399.00	\$1,343.04	\$1,287.08	\$1,231.12		

4.1/9.5 Mini DIN Connectors



Frequency Range (MHz.)	Coupling (dB)	Maximum Power	Directivity (dB)	Model No	1 Pc. Price	See Web for Volume Pricing	ROW	
698-2,700	6	200 Watt	20	PE2CP1059	\$479.32	See Web for Volume Pricing	9	
	10			PE2CP1063	\$475.84			10
	15			PE2CP1067	\$549.35			11
	20			PE2CP1071	\$475.84			12
	30			PE2CP1075	\$475.84			13

4.3-10 Connectors



Frequency Range (MHz.)	Coupling (dB)	Maximum Power	Directivity (dB)	Model No	1-4	5-9	10-24	25+	ROW
698-2,700	6	200 Watt	20	PE2CP1060	\$521.00	\$494.95	\$468.90	\$448.06	14
	10			PE2CP1064	\$521.00	\$494.95	\$468.90	\$448.06	15
	15			PE2CP1068	\$521.00	\$494.95	\$468.90	\$448.06	16
	20			PE2CP1072	\$521.00	\$494.95	\$468.90	\$448.06	17
	30			PE2CP1076	\$521.00	\$494.95	\$468.90	\$448.06	18

Couplers & Hybrids

7/16 DIN Connectors



Frequency Range (MHz.)	Coupling (dB)	Maximum Power	Directivity (dB)	Model No	1-4	5-9	10-24	25+	ROW
698-2,700	6	200 Watt	20	PE2CP1058	\$503.63	\$478.45	\$453.27	\$433.12	19
	10			PE2CP1062	\$581.42	\$552.35	\$523.28	\$500.02	20
	15			PE2CP1066	\$581.42	\$552.35	\$523.28	\$500.02	21
	20			PE2CP1070	\$523.27	\$497.11	\$470.94	\$450.01	22
	30			PE2CP1074	\$523.27	\$497.11	\$470.94	\$450.01	23

N Connectors



Frequency Range (MHz.)	Coupling (dB)	Maximum Power	Directivity (dB)	Model No	1 Pc. Price	See Web for Volume Pricing			ROW		
500-2,000	30	600 Watt	18	PE2240-30	\$1,166.67	See Web for Volume Pricing			24		
698-2,700	6	200 Watt	20	PE2CP1057	\$469.14				25		
	10			PE2CP1061	\$521.29				26		
	15			PE2CP1065	\$521.29				27		
	20			PE2CP1069	\$540.28				28		
	30			PE2CP1073	\$540.28				29		
800-2,500	6	60 Watt	20	PE2CP1023-6	\$507.76				30		
	10			PE2CP1023-10	\$509.26						
	20			PE2CP1023-20	\$508.84						
1,000-2,000	30	600 Watt	28	PE2226-30	\$1,260.24				31		
1,000-4,000				PE2228A-30	\$1,759.02				32		
1,000-8,000				PE2239-30	\$1,898.35				33		
1,000-11,000				35	20				PE2236-35	\$2,537.44	34
2,000-4,000					18				PE2227-30	\$1,470.65	35
4,000-8,000	30	600 Watt	15	PE2230-30	\$1,305.46				36		
4,000-12,000				PE2235-30	\$1,627.26	37					
5,000-11,000				PE2234-30	\$1,031.46	38					

SMA Connectors



Frequency Range (MHz.)	Coupling (dB)	Maximum Power	Directivity (dB)	Model No	1 Pc. Price	See Web for Volume Pricing			ROW	
500-1,000	10		25	PE2200-10	\$396.54	See Web for Volume Pricing			39	
	20			PE2200-20	\$441.11				40	
	30			PE2200-30	\$443.91				41	
500-2,000	6	50 Watt	20	PE2CP003-6	\$396.33				42	
				PE2208-6	\$505.13				43	
				PE2CP003-10	\$274.55				44	
	10			PE2208-10	\$519.71				45	
				20	PE2CP003-20				\$291.49	46
				23	PE2208-20				\$534.69	47
500-3,000	10	30 Watt	18	PE2242-10	\$279.00				48	
				PE2242-20	\$279.00				49	
	20			PE2242A-20	\$279.00				50	
				PE2242-30	\$279.00				51	
500-18,000	30	50 Watt	18	PE2242A-30	\$269.97				52	
				PE2243-10	\$1,426.60				53	
	10			PE2243-16	\$1,405.51	54				
				PE2243-20	\$1,483.00	55				
600-4,000	10			PE2243-30	\$1,426.60					
700-2,700	6	50 Watt	20	PE2213-10	\$747.00					
	10			PE2CP002-6	\$259.16					
	20			PE2CP002-10	\$259.16					
800-2,200	10			PE2CP002-20	\$269.35					
	6			PE2CP025-10	\$216.31					
800-2,500	10			PE2CP1024-6	\$496.93					
	6			PE2CP1025-10	\$521.29					

Couplers & Hybrids

Single Directional SMA Connectors



Couplers & Hybrids

Frequency Range (MHz.)	Coupling (dB)	Maximum Power	Directivity (dB)	Model No	1 Pc. Price	See Web for Volume Pricing	ROW	
800-2,500	20	50 Watt	20	PE2CP1025-20	\$465.53	See Web for Volume Pricing	55	
	30			PE2CP1024-30	\$509.26		56	
1,000-2,000	10		25	PE2201-10	\$364.01		57	
	20			PE2CP1108	\$173.17		58	
1,000-4,000	30		20	PE2201-30	\$369.88		59	
	6			PE2CP005-6	\$215.45		60	
				PE2209-6	\$516.82		61	
	10			PE2CP005-10	\$208.19		62	
				PE2CP1102	\$159.31		63	
	20			PE2CP005-20	\$221.08		64	
2,000-4,000	6		22	PE2209-20	\$554.89		65	
				PE2202-6	\$363.65		66	
				PE2202-20	\$375.25			
2,000-8,000	20		PE2202-30	\$381.70	20		67	
			PE2CP004-6	\$283.95				
	10		PE2210-6	\$492.03				68
			PE2CP004-10	\$300.80				69
	20		PE2210-10	\$494.47				70
		PE2CP004-20	\$295.02	71				
2,000-18,000	6	50 Watt	PE2210-20	\$507.95	72			
			PE2215-6	\$1,799.00	73			
			10	PE2CP000-10	\$618.32	74		
				PE2CP1103	\$443.31	75		
2,000-18,400	20	25 Watt	PE2215-10	\$2,029.30	76			
			PE2CP000-20	\$651.82	77			
2,600-5,200	10	50 Watt	PE2CP000-30	\$633.54	78			
			PE2215-20	\$1,734.07	79			
			20	PE2203-10	\$522.25	80		
				PE2CP1109	\$180.09	81		
4,000-8,000	6	50 Watt	PE2203-20	\$533.01	82			
			PE2203-30	\$546.71				
			PE2204-6	\$374.36				
			PE2204-10	\$370.69				
			PE2204-20	\$375.35				
			PE2204-30	\$409.93				
4,000-12,400	10	17	PE2211-6	\$540.28	83			
			PE2211-10	\$494.29				
			PE2211-20	\$521.06				
4,000-18,000	6	12	PE2CP1100	\$380.97	84			
			PE2CP1104	\$380.97	85			
			PE2CP1110	\$380.97	86			
6,000-18,000	10	10	PE2CP001-10	\$478.94	87			
			PE2CP001-20	\$478.94				
6,000-26,500	30	30 Watt	13	PE2CP1120-30	\$999.00	88		
6,000-26,600	20			PE2CP1120-20	\$1,037.96			
7,000-12,400	6	50 Watt	17	PE2CP1101	\$304.77	89		
				PE2CP1105	\$304.77	90		
				PE2205-20	\$489.88	91		
				PE2205-30	\$489.00			
7,000-16,000	30	12	PE2CP1112	\$342.87	92			
7,000-18,000	10		PE2CP1106	\$311.70	93			
		PE2212-10	\$644.18	94				
7,500-16,000	6	12	PE2206-6	\$471.02	95			
			PE2CP1107	\$293.33				
12,400-18,000	10	4 Watt	15	PE2207-6	\$557.35	96		
				PE2207-10	\$482.40	97		
	20	PE2CP1111	\$339.41	98				
		PE2207-20	\$476.90	99				
	30			PE2207-30	\$498.72			

Dual Directional

N Connectors



Frequency Range (MHz.)	Coupling (dB)	Maximum Power	Directivity (dB)	Model No	1	2-4	5-9	10+	ROW
2-30	50	2500 Watt	22	PE2CP1000	\$3,009.65	\$2,889.26	\$2,768.88	\$2,648.49	1
20-500		500 Watt		PE2CP1002	\$1,752.16	\$1,682.07	\$1,611.99	\$1,541.90	2
20-1,000		1000 Watt		PE2CP1003	\$2,341.43	\$2,247.77	\$2,154.12	\$2,060.46	3
		500 Watt		PE2CP1005	\$1,740.27	\$1,670.66	\$1,601.05	\$1,531.44	4
80-1,000	40	1000 Watt	20	PE2CP1007	\$1,704.76	\$1,636.57	\$1,568.38	\$1,500.19	5
		1000 Watt		PE2CP1008	\$2,430.78	\$2,333.55	\$2,236.32	\$2,139.09	6
200 Watt		PE2CP1021		\$1,424.73	\$1,367.74	\$1,310.75	\$1,253.76	7	
500 Watt		PE2CP1010		\$1,598.24	\$1,534.31	\$1,470.38	\$1,406.45	8	
100-500	20	1000 Watt	18	PE2CP1020	\$2,278.86	\$2,187.71	\$2,096.55	\$2,005.40	9
500-2,500		200 Watt		PE2CP1011	\$1,102.16	\$1,058.07	\$1,013.99	\$969.90	10
		500 Watt		PE2CP1012	\$1,649.86	\$1,583.87	\$1,517.87	\$1,451.88	11
500-3,000		200 Watt		PE2CP1013	\$1,775.83	\$1,704.80	\$1,633.76	\$1,562.73	12
800-2,500	20	500 Watt	20	PE2CP1015	\$1,709.49	\$1,641.11	\$1,572.73	\$1,504.35	13
800-4,200		200 Watt		PE2CP1016	\$2,035.23	\$1,953.82	\$1,872.41	\$1,791.00	14
2,000-6,000				PE2CP1019	\$1,435.34	\$1,377.93	\$1,320.51	\$1,263.10	15

SC Connectors



Frequency Range (MHz.)	Coupling (dB)	Maximum Power	Directivity (dB)	Model No	1	2-4	5-9	10+	ROW
20-1,000	50	1000 Watt	20	PE2CP1006	\$2,708.65	\$2,600.30	\$2,491.96	\$2,383.61	16
800-4,200	40	600 Watt	18	PE2CP1017	\$2,785.27	\$2,673.86	\$2,562.45	\$2,451.04	17

SMA Connectors



Frequency Range (MHz.)	Coupling (dB)	Maximum Power	Directivity (dB)	Model No	1 Pc. Price	See Web for Volume Pricing			ROW		
20-520	50	200 Watt	20	PE2CP1001	\$1,120.55				18		
20-1,000				PE2CP1004	\$1,405.85				19		
100-500				PE2CP1009	\$1,286.62				20		
500-1,000	10	10 Watt	22	PE2217-10	\$753.26				21		
	20			PE2217-20	\$765.40				21		
	30			PE2217-30	\$735.95				21		
800-2,500	40	200 Watt	20	PE2CP1014	\$1,069.49				22		
	10			PE2218-10	\$735.95				23		
	20			PE2218-20	\$735.95						
1,000-2,000	30	50 Watt	22	PE2218-30	\$745.94				23		
	10			10 Watt	20				PE2219-10	Call	24
	20								PE2219-20	\$847.59	
2,000-4,000	20	50 Watt	16	PE2CP1018	\$1,058.65				25		
2,000-6,000		100 Watt		20	PE2CP1113				\$616.47	26	
2,000-8,000					50 Watt				PE2220-10		\$771.83
2,600-5,200	10	10 Watt	18	PE2220-20	\$681.08				27		
	20			PE2220-30	\$693.91						
	30			PE2221-10	\$749.83						
4,000-8,000	30	10 Watt	16	PE2222-30	\$735.95				28		
7,000-12,400				10 Watt	15				PE2223-10	\$735.95	30
8,000-16,000									20	PE2223-20	
	12,400-18,000	30	50 Watt	15	PE2223-30	\$764.53				30	
20		PE2224-20			\$758.69						
30		PE2224-30			\$811.57						

90 Degree Hybrids

2.92mm Connectors



Frequency Range (MHz.)	Coupling (dB)	Maximum Power	Minimum Isolation (dB)	Model No	1-4	5-9	10-24	25+	ROW
2,000-40,000	3	20 Watt	10	PE2CP1150	\$1,875.00	\$1,781.25	\$1,687.50	\$1,612.50	32
5,000-26,500			14	PE2CP1147	\$937.50	\$890.63	\$843.75	\$806.25	33
8,000-43,500			12	PE2CP1149	\$1,406.25	\$1,335.94	\$1,265.63	\$1,209.38	34
10,000-26,500			15	PE2CP1146	\$937.50	\$890.63	\$843.75	\$806.25	35
20,000-40,000			12	PE2CP1148	\$1,406.25	\$1,335.94	\$1,265.63	\$1,209.38	36

Pin Connectors

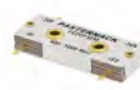

Frequency Range (MHz.)	Coupling (dB)	Maximum Power	Minimum Isolation (dB)	Model No	1 Pc. Price	See Web for Volume Pricing	ROW	
20-1,000		50 Watt	16	PE2CP1026	\$807.84	See Web for Volume Pricing	37	
		150 Watt		PE2CP1027	\$914.41		38	
80-1,000		250 Watt	16	PE2CP1028	\$641.79		39	
		150 Watt		PE2CP1029	\$300.03		40	
100-500		200 Watt	20	PE2CP1032	\$92.01		41	
		800 Watt		PE2CP1033	\$395.33		42	
225-400		250 Watt	18	PE2CP1034	\$109.30		43	
		400 Watt		PE2CP1035	\$152.41		44	
225-450		800 Watt	20	PE2CP1036	\$395.33		45	
		200 Watt		PE2CP1037	\$81.39		46	
		400 Watt		PE2CP1038	\$117.71		47	
400-1,000		800 Watt	20	PE2CP1039	\$460.43		48	
		150 Watt		PE2CP1040	\$184.87		49	
		200 Watt		PE2CP1041	\$281.34		50	
500-2,500		300 Watt	17	PE2CP1042	\$400.50		51	
		125 Watt		PE2CP1043	\$184.87		52	
		200 Watt		PE2CP1044	\$335.89		53	
500-3,000		200 Watt	17	PE2CP1045	\$90.63		54	
				18	PE2CP1046		\$144.44	55
				17	PE2CP1047		\$678.65	56
800-1,600		400 Watt	17	PE2CP1048	\$81.39		57	
				200 Watt	PE2CP1049		\$81.39	58
800-2,500		400 Watt	20	PE2CP1050	\$108.46		59	
				1000 Watt	PE2CP1051		\$460.43	60
800-2,700		150 Watt	18	PE2CP1052	\$95.35		61	
				450 Watt	PE2CP1053		\$174.41	62
960-1,220		80 Watt	16	PE2CP1054	\$159.07		63	
				100 Watt	PE2CP1055		\$81.39	64
1,000-2,000		100 Watt	18	PE2CP1056	\$85.54	65		

SMA Connectors



Frequency Range (MHz.)	Coupling (dB)	Maximum Power	Minimum Isolation (dB)	Model No	1 Pc. Price	See Web for Volume Pricing	ROW
500-1,000	3	50 Watt	22	PE2CP011	\$248.00	See Web for Volume Pricing	66
		100 Watt	28	PE2CP1140	\$468.75		67
800-3,000		50 Watt	20	PE2050	\$522.91		68
		50 Watt	22	PE2CP021	\$367.80		69
1,000-2,000		100 Watt	22	PE2CP013	\$248.00		70
		100 Watt	28	PE2051	\$462.87		71
1,000-18,000	3	50 Watt	15	PE2CP1144	\$596.88		72
			23	PE2CP1145	\$521.88		73
2,000-4,000		50 Watt	22	PE2CP017	\$248.00		74
			22	PE2052	\$453.53		75
2,000-8,000		30 Watt	17	PE2058	\$515.30		76
2,000-18,000		50 Watt	15	PE2CP023	\$1,014.03		77
			18	PE2CP019	\$248.00		78

Couplers & Hybrids

SMA Connectors



Frequency Range (MHz.)	Coupling (dB)	Maximum Power	Minimum Isolation (dB)	Model No	1 Pc. Price	See Web for Volume Pricing			R O W
4,000-12,400	4	100 Watt		PE2059	\$782.12				79
4,000-18,000	3	50 Watt	16	PE2CP1143	\$521.88	See Web for Volume Pricing			80
5,000-10,000			20	PE2CP1141	\$468.75				81
6,000-18,000		30 Watt	16	PE2CP1142	\$550.00				82
6,000-12,400		100 Watt	17	PE2055	\$569.65				83
7,000-18,000		30 Watt	18	PE2CP1022	\$664.74				84
7,500-16,000		100 Watt		PE2056A	\$553.80				85
12,000-18,000		40 Watt	15	PE2057	\$500.00				86

180 Degree Hybrids

2.92mm Connectors



Frequency Range (MHz.)	Coupling (dB)	Maximum Power	Minimum Isolation (dB)	Model No	1-4	5-9	10-24	25+	R O W
26,500-40,000	3	20 Watt	15	PE2CP1161	\$1,956.25	\$1,858.44	\$1,760.63	\$1,682.38	87

SMA Connectors



Frequency Range (MHz.)	Coupling (dB)	Maximum Power	Minimum Isolation (dB)	Model No	1-4	5-9	10-24	25+	R O W
500-1,000	3	50 Watt	22	PE2CP1151	\$646.88	\$614.53	\$582.19	\$556.31	88
1,000-2,000				PE2CP1152	\$646.88	\$614.53	\$582.19	\$556.31	89
1,300-2,600		100 Watt	20	PE2CP1153	\$646.88	\$614.53	\$582.19	\$556.31	90
1,400-6,000		30 Watt	22	PE2CP1154	\$1,262.50	\$1,199.38	\$1,136.25	\$1,085.75	91
2,000-4,000		50 Watt	20	PE2CP1155	\$646.88	\$614.53	\$582.19	\$556.31	92
2,000-8,000				PE2CP1157	\$843.75	\$801.56	\$759.38	\$725.63	93
2,000-18,000		50 Watt	16	PE2CP1158	\$1,312.50	\$1,246.88	\$1,181.25	\$1,128.75	94
4,000-8,000		80 Watt	18	PE2CP1159	\$718.75	\$682.81	\$646.88	\$618.13	95
4,000-18,000		50 Watt		PE2CP1160	\$978.13	\$929.22	\$880.31	\$841.19	96

RF DIPLEXERS

75 Ohm Diplexer F Female with 5 MHz to 390 MHz Low Pass and 650 MHz to 1,000 MHz High Pass [PE8DP1001](#)

- 5 - 1000 MHz
- 75 Ohms Impedance
- Typical Return loss 18 dB
- Bidirectional design
- EN 50083-2 Class A Standard



In-stock and available to ship today!

FILTERS

NEW

Low Pass Harmonic Filters: [PEHFL0000](#) - [PEHFL0001](#)

- Passband frequency: DC - 6000Hz
- 50 Ohms impedance
- Broadband design: C, L & S Band
- RF input power passband: 50 W
- VSWR: 1.5:1



In-stock and available to ship today!

SMA Connectors

Bandpass Filters



Bandpass Frequency (MHz)	Rejection (MHz)	Max. Insertion Loss (dB)	Model No	1 Pc. Price	See Web for Volume Pricing	ROW
824 - 849	50 dB at 736.5 50 dB at 936.5	2	PE8705	\$474.42	See Web for Volume Pricing	6
869 - 894	50 dB at 781.5 50 dB at 981.5		PE8706	\$488.10		7
902 - 928	50 dB at 815 50 dB at 1,015		PE8700	\$492.92		8
1,000 - 2,000	55 dB at 650 55 dB at 3,000		PE87FL1012	\$423.68		9
1,217 - 1,237	50 dB at 1,127 50 dB at 1,327	1	PE8704	\$449.00		10
1,565 - 1,585	50 dB at 1,475 50 dB at 1,675	2	PE8703	\$492.92		11
1,710 - 1,770	50 dB at 1,490 50 dB at 1,990		PE8710	\$488.10		12
1,850 - 1,910	50 dB at 1,630 50 dB at 2,130		PE8707	\$493.40		13
1,920 - 1,980	50 dB at 1,700 50 dB at 2,200	2	PE8709	\$518.46		14
1,930 - 1,990	50 dB at 1,710 50 dB at 2,210	1	PE8708	\$585.72		15
2,000 - 4,000	55 dB at 1,300 55 dB at 6,000		PE87FL1013	\$440.20		16
2,110 - 2,170	50 dB at 1,890 50 dB at 2,390		PE8711	\$726.32		17
2,400 - 2,500	50 dB at 2,050 50 dB at 2,850	1	PE8701	\$491.93		18
2,500 - 2,700	50 dB at 1,700 50 dB at 3,500	2	PE8712	\$562.80		19
3,300 - 3,700	50 dB at 1,600 50 dB at 5,400		PE8713	\$517.29		20
4,400 - 4,950	30 dB at 5,250 30 dB at 5,850	1	PE8739	\$364.70		21
4,900 - 5,900	50 dB at 400 50 dB at 10,400	1	PE8714	\$465.29		22
5,250 - 5,850	30 dB at 4,400 30 dB at 4,950		PE8740	\$367.45		23
5,725 - 5,875	50 dB at 5,200 50 dB at 6,400		PE8702	\$478.70		24
7,250 - 7,750	30 dB at 7,900 30 dB at 8,400	2	PE8741	\$391.55		25
7,900 - 8,400	30 dB at 7,250 30 dB at 7,750		PE8742	\$391.55		26
9,900 - 10,800	50 dB at 8,350 50 dB at 12,350	1	PE87FL1000	\$500.41		27
10,550 - 11,800	50 dB at 8,425 50 dB at 13,925		PE87FL1001	\$500.41		28
10,700 - 12,200	50 dB at 8,450 50 dB at 14,450		PE87FL1003	\$500.41		29
11,700 - 12,800	50 dB at 9,750 50 dB at 14,750		PE87FL1002	\$500.41		30

SMA Connectors

Bandpass Filters



Bandpass Frequency (MHz)	Rejection (MHz)	Max. Insertion Loss (dB)	Model No	1 Pc. Price	See Web for Volume Pricing			ROW
12,200 - 12,700	50 dB at 11,450 50 dB at 13,450	2	PE87FL1004	\$500.41	See Web for Volume Pricing			31
14,000 - 14,800	50 dB at 12,850 50 dB at 15,950		PE87FL1005	\$467.67				32
17,200 - 18,200	35 dB at 16,200 35 dB at 19,200	1	PE87FL1008	\$467.67				33
17,200 - 21,200	50 dB at 13,450 50 dB at 24,950		PE87FL1007	\$450.12				34
17,300 - 18,100	50 dB at 16,200 50 dB at 19,200	2	PE87FL1006	\$500.41				35
17,700 - 21,200	50 dB at 16,000 50 dB at 24,000		PE8743	\$427.01				36
18,200 - 19,200	35 dB at 17,200 35 dB at 20,200	2	PE87FL1009	\$467.67				37
19,200 - 20,200	35 dB at 18,200 35 dB at 21,200		PE87FL1010	\$467.67				38
20,200 - 21,200	35 dB at 19,200 35 dB at 22,200	3	PE87FL1011	\$450.12				39
27,500 - 31,000	50 dB at 25,000 50 dB at 32,750		PE8747	\$431.97				40

Highpass Filters



Bandpass Frequency (MHz)	Rejection (MHz)	Max. Insertion Loss (dB)	Model No	1 Pc. Price	See Web for Volume Pricing			ROW
100 - 300	60 dB at 15	1	PE8717	\$382.85	See Web for Volume Pricing			41
100 - 750	60 dB at 50		PE8716	\$610.58				42
100 - 2,500	60 dB at 500		PE8715	\$382.85				43
300 - 1,000	60 dB at 150	PE8718	\$364.99	44				
1,000 - 13,000	40 dB at 0	2	PE87FL1018	\$785.11				45
2,000 - 18,000			PE87FL1019	\$770.01	46			

Lowpass Filters



Bandpass Frequency (MHz)	Rejection (MHz)	Max. Insertion Loss (dB)	Model No	1 Pc. Price	See Web for Volume Pricing			ROW
DC - 30	60 dB at 60	1	PE8723	\$347.72	See Web for Volume Pricing			47
DC - 100	60 dB at 200		PE8719	\$341.35				48
DC - 225	60 dB at 450		PE8722	\$328.54				49
DC - 300	60 dB at 600		PE8724	\$548.25				50
DC - 400	60 dB at 800		PE8726	\$251.13				51
DC - 700	60 dB at 1,400		PE8727	\$363.63				52
DC - 1,000	60 dB at 2,000		PE8720	\$331.78				53
DC - 2,000	60 dB at 4,000		PE8721	\$331.78				54
DC - 3,000	60 dB at 6,000		PE8725	\$387.62				55
DC - 4,400	50 dB at 12,000		2	PE87FL1014				\$440.20
DC - 7,000	50 dB at 15,000	PE87FL1015		\$440.20	57			
DC - 9,500	50 dB at 18,000	PE87FL1016		\$440.20	58			
DC - 11,000		PE87FL1017		\$440.20	59			

N Connectors

Band Pass



Bandpass Frequency (MHz)	Rejection (MHz)	Max. Insertion Loss (dB)	Model No	1	2-4	5-9	10+	ROW
125 - 250			PE8728	\$2,234.57	\$2,156.36	\$2,078.15	\$2,011.11	60
250 - 500			PE8729	\$2,279.90	\$2,200.10	\$2,120.31	\$2,051.91	61
500 - 1 GHz			PE8730	\$2,437.90	\$2,352.57	\$2,267.25	\$2,194.11	62
750 - 1.5 GHz			PE8731	\$2,414.53	\$2,330.02	\$2,245.51	\$2,173.08	63
1 GHz - 2 GHz			PE8732	\$2,193.06	\$2,116.30	\$2,039.55	\$1,973.75	64
1.5 GHz - 3 GHz			PE8733	\$2,421.28	\$2,336.54	\$2,251.79	\$2,179.15	65

Band Reject



Bandpass Frequency (MHz)	Rejection (MHz)	Max. Insertion Loss (dB)	Model No	1	2-4	5-9	10+	ROW
100 - 200			PE8734	\$2,478.62	\$2,391.87	\$2,305.12	\$2,230.76	66
200 - 400			PE8735	\$2,235.68	\$2,157.43	\$2,079.18	\$2,012.11	67
250 - 500			PE8736	\$2,643.87	\$2,551.33	\$2,458.80	\$2,379.48	68
1 GHz - 2 GHz			PE8738	\$2,390.09	\$2,306.44	\$2,222.78	\$2,151.08	69

FREQUENCY DIVIDERS



Input Frequency (GHz)	Divide-By Prescaler	CW Input Power (CW) (dBm)	Typ Power Out (dBm)	Phase Noise @100 kHz (dBc/Hz)	DC Bias (Volts/mA)	Model No	1	2-4	5-9	10+	ROW
0.1 - 7	3	-12	-1	-150	+12 / 70	PE88D3000	\$942.03	\$885.51	\$838.41	\$800.73	70
	5				+12 / 80	PE88D25000	\$906.67	\$852.27	\$806.94	\$770.67	71
	15				+12 / 150	PE88D15000	\$1,000.00	\$940.00	\$890.00	\$850.00	72
0.1 - 12	8		-6	-153	+12 / 70	PE88D8003	\$1,003.33	\$943.13	\$892.96	\$852.83	73
	24				+12 / 140	PE88D24000	\$1,160.00	\$1,090.40	\$1,032.40	\$986.00	74
	40				+12 / 150	PE88D40000	\$1,160.00	\$1,090.40	\$1,032.40	\$986.00	75
0.1 - 12.5	10			-144	+12 / 185	PE88D1001	\$1,205.24	\$1,132.93	\$1,072.66	\$1,024.45	76
0.1 - 13	4		5	-151	+12 / 120	PE88D4003	\$1,073.63	\$1,009.21	\$955.53	\$912.59	77
	12				+12 / 185	PE88D12000	\$1,160.00	\$1,090.40	\$1,032.40	\$986.00	78
	20				+12 / 195	PE88D20000	\$1,160.00	\$1,090.40	\$1,032.40	\$986.00	79
0.1 - 15	5		5	-153	+5 / 205	PE88D5001	\$1,503.33	\$1,413.13	\$1,337.96	\$1,277.83	80
	6				+5 / 205	PE88D6000	\$1,503.33	\$1,413.13	\$1,337.96	\$1,277.83	81
	7				+5 / 205	PE88D7000	\$1,503.33	\$1,413.13	\$1,337.96	\$1,277.83	82
	9				+5 / 205	PE88D9000	\$1,503.33	\$1,413.13	\$1,337.96	\$1,277.83	83
0.1 - 20	2				+5 / 160	PE88D2002	\$1,561.96	\$1,468.24	\$1,390.14	\$1,327.67	84
	4				+5 / 170	PE88D4002	\$1,503.33	\$1,413.13	\$1,337.96	\$1,277.83	85
	8				+5 / 175	PE88D8002	\$1,503.33	\$1,413.13	\$1,337.96	\$1,277.83	86
0.2 - 6	10		-2		+12 / 100	PE88D1002	\$813.33	\$764.53	\$723.86	\$691.33	87
	20				+12 / 95	PE88D20001	\$813.33	\$764.53	\$723.86	\$691.33	88
0.4 - 4	16		-1		+12 / 75	PE88D16000	\$720.00	\$676.80	\$640.80	\$612.00	89
	32				+12 / 75	PE88D32000	\$720.00	\$676.80	\$640.80	\$612.00	90
0.5 - 8	5	-20	-1		+5 / 80	PE88D5000	\$2,751.07	\$2,641.03	\$2,530.98	\$2,420.94	91
0.5 - 18	2	-15	-4	-147	+12 / 85	PE88D2001	\$1,376.67	\$1,294.07	\$1,225.24	\$1,170.17	92
	4	-20			+5 / 93	PE88D4000	\$3,864.98	\$3,710.38	\$3,555.78	\$3,401.18	93
					+12 / 110	PE88D4001	\$1,376.67	\$1,294.07	\$1,225.24	\$1,170.17	94
					+12 / 110	PE88D8001	\$1,430.36	\$1,344.54	\$1,273.02	\$1,215.81	95
	8	-15			+5 / 152	PE88D1000	\$4,220.73	\$3,967.49	\$3,756.45	\$3,587.62	96

MIXERS

Double Balanced



RF Range (GHz)	LO Range (GHz)	IF Range (GHz)	LO Power (dBm)	Conv. Loss (dB)	Connector	Model No	1 Pc. Price	See Web for Volume Pricing			ROW
0.5 MHz- 500 MHz	0.5 MHz- 500 MHz	DC - 500 MHz	10	6.8	SMA	PE86X1013	\$322.84				1
1 MHz- 2.7	1 MHz- 2.7	1 MHz - 2	10	7	SMA	PE86X1020	\$411.89				2
1 MHz- 2.7			PE86X1021			\$504.66	3				
5 MHz- 1	5 MHz- 1	DC - 1	7	7	SMA	PE86X1014	\$322.84				4
5 MHz- 1			PE86X1016			\$310.72	5				
5 MHz- 1.5	5 MHz- 1.5	DC - 1	7	7.5	SMA	PE86X1018	\$322.84				6
5 MHz- 3.5	5 MHz- 3.5	5 MHz - 2.5	13	8	SMA	PE86X1022	\$378.58				7
5 MHz- 4.2	5 MHz- 4.2	5 MHz - 3.5	13	9.8	SMA	PE86X1023	\$411.89				8
10 MHz- 1	10 MHz- 1	DC - 800 MHz	4	7.2	SMA	PE86X1015	\$322.84				9
10 MHz- 1.2	10 MHz- 1.2	DC - 1.2	13	8	SMA	PE86X1017	\$328.58				10
40 MHz- 2.5	40 MHz- 2.5	DC - 1	13	8	SMA	PE86X1019	\$449.00				11
800 MHz- 4.2	800 MHz- 4.2	DC - 800 MHz	13	9	SMA	PE86X1024	\$359.94				12
2 - 8	2 - 8	DC - 1.5	10	5.5	SMA	PE8650	\$701.00				13
2 - 18	2 - 18	DC - 600 MHz	10	6.5	SMA	PE8652	\$908.92				14
2.25 - 18	2.25 - 18	DC - 3	13	11	SMA	PE86X1026	\$1,150.33				15
2.5 - 6	2.5 - 6	DC - 1.5	17	8.7	SMA	PE86X1025	\$467.55				16
3 - 10	3 - 10	DC - 4	17	9	SMA	PE86X1027	\$1,150.33				17
5 - 18	5 - 18	DC - 4	10	6.2	SMA	PE8653	\$999.43				18
5 - 20	5 - 20	DC - 3	20	10	SMA	PE86X1006	\$1,424.08				19
5 - 20						PE86X1008	\$1,420.59	20			
6 - 18	6 - 18	DC - 3	6	7.5	SMA	PE86X1007	\$1,476.18				21
6 - 26	6 - 26	DC - 8	13	10	SMA	PE86X1028	\$1,257.94				22
7 - 14	7 - 14	DC - 5	13		SMA	PE86X1003	\$4,601.37				23
7 - 34	7 - 34	DC - 8	13	11	2.92mm	PE86X1029	\$1,350.00				24
7 - 43	7 - 43	DC - 10	13	9	2.92mm	PE86X1009	\$2,930.00				25
11 - 20	11 - 20	DC - 6	13		2.92mm	PE86X1004	\$2,859.67				26
16 - 30	16 - 30	DC - 8	13	9	2.92mm	PE86X1030	\$1,402.65				27
16 - 32	16 - 32	DC - 8	13		2.92mm	PE86X1000	\$3,402.00				28
23 - 37	23 - 37	DC - 13	13	9	2.92mm	PE86X1002	\$4,265.00				29
24 - 32	24 - 32	DC - 8	13	10.5	2.92mm	PE86X1031	\$1,350.00				30
24 - 38	24 - 38	DC - 8	13	9	2.92mm	PE86X1001	\$4,581.99				31
24 - 40	24 - 40	DC - 18	13	8	2.92mm	PE86X1010	\$2,392.63				32

See Web for Volume Pricing

IQ



RF Range (GHz)	LO Range (GHz)	IF Range (GHz)	LO Power (dBm)	Conv. Loss (dB)	Connector	Model No	1	2-4	5-9	10+	ROW
4 - 8.5	4 - 8.5	DC - 3.5	15		SMA	PE86X9000	\$3,114.79	\$3,005.77	\$2,896.75	\$2,803.31	33
6 - 10	6 - 10	DC - 3.5	19	7.5	SMA	PE86X9001	\$3,114.79	\$2,990.20	\$2,865.61	\$2,741.02	34
8.5 - 13.5	8.5 - 13.5	DC - 2	19	8	SMA	PE86X9002	\$3,419.09	\$3,282.33	\$3,145.56	\$3,008.80	35
11 - 16	11 - 16	DC - 3.5	19	9	SMA	PE86X9003	\$3,737.05	\$3,587.57	\$3,438.09	\$3,288.60	36
15 - 23	15 - 23	DC - 3.5	17	8	SMA	PE86X9004	\$4,051.61	\$3,889.55	\$3,727.48	\$3,565.42	37
20 - 31	20 - 31	DC - 4.5	17	10	2.92mm	PE86X9005	\$5,147.79	\$4,941.88	\$4,735.97	\$4,530.06	38
30 - 38	30 - 38	DC - 3.5	17		2.92mm	PE86X9006	\$5,179.26	\$4,972.09	\$4,764.92	\$4,557.75	39

Triple Balanced



RF Range (GHz)	LO Range (GHz)	IF Range (GHz)	LO Power (dBm)	Conv. Loss (dB)	Connector	Model No	1-4	5-9	10-24	25+	ROW
6 - 18	6 - 18	1.5 - 8	10	7	SMA	PE8654	\$999.43	\$949.46	\$899.49	\$859.51	40

See Our Website For Current Pricing & Real-Time Stock Availability!

Frequency Conversion Components

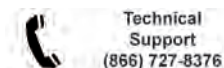

Technical Support
(866) 727-8376



Same-Day Shipping,
Even Custom Cable Assemblies

MODULATOR

BiPhase



Freq. Band (GHz)	Insertion Loss (dB)	Switching Speed (nsec)	Phase State (On/Off)	VSWR	RF Input Power (CW) (dBm)	Max Peak RF Input Power (1usec)	RF Conn.	Model No	1	2-4	5-9	10+	ROW
0.5 MHz to 1	1.5	50	0°/180°	1.5:1	+20	0.5	SMA Female	PE86GM2000	\$3,483.33	\$3,361.41	\$3,239.50	\$3,135.00	41
1 to 2	3	30						PE86GM2001	\$3,716.67	\$3,586.59	\$3,456.50	\$3,345.00	42
2 to 4	2.5	75						PE86GM2002	\$3,950.00	\$3,811.75	\$3,673.50	\$3,555.00	43
2 to 6	1.7	50		1.6:1	+27			PE86GM2003	\$4,183.33	\$4,036.91	\$3,890.50	\$3,765.00	44
4 to 8	2.5	30		2.0:1	PE86GM2004			\$4,416.67	\$4,262.09	\$4,107.50	\$3,975.00	45	
6 to 12		15			PE86GM2005			\$4,650.00	\$4,487.25	\$4,324.50	\$4,185.00	46	
8 to 18	3	75			PE86GM2006			\$4,883.33	\$4,712.41	\$4,541.50	\$4,395.00	47	
2 to 18	3.5	35			1.9:1			PE86GM2007	\$5,816.67	\$5,613.09	\$5,409.50	\$5,235.00	48
26.5 to 40	5.5	50		2.0:1	PE86GM2008		\$6,983.33	\$6,738.91	\$6,494.50	\$6,285.00	49		

FREQUENCY MULTIPLIERS

Active



Input Freq. (GHz)	Output Freq. (GHz)	Input Drive Power (dBm)	Out Pwr Typ (dBm)	Fund. Iso. Typ (dB)	3rd Harmonics (dBc)	CW Pwr In (dBm)	Female In/Out Conn.	Model No	1	2-4	5-9	10+	ROW
4 - 10.5	8 - 21	6	14				SMA	PE88X2003	\$4,684.14	\$4,496.77	\$4,309.41	\$4,122.04	50
9 - 14.5	18 - 29		16				2.92mm	PE88X2000	\$4,508.47	\$4,328.13	\$4,147.79	\$3,967.45	51
12 - 16.5	24 - 33		17				PE88X2001	\$4,433.24	\$4,255.91	\$4,078.58	\$3,901.25	52	
16 - 23	32 - 46		13				PE88X2002	\$4,946.53	\$4,748.67	\$4,550.81	\$4,352.95	53	

*Field Replaceable Connectors

Passive



Input Freq. (GHz)	Output Freq. (GHz)	Input Drive Power (dBm)	Out Pwr Typ (dBm)	Fund. Iso. Typ (dB)	3rd Harmonics (dBc)	CW Pwr In (dBm)	Female In/Out Conn.	Model No	1-4	5-9	10-24	25+	ROW
1.5 - 5	3 - 10			25		13	SMA	PE8600	\$684.16	\$649.95	\$615.74	\$588.38	54
2 - 6	4 - 12							PE8601	\$720.09	\$684.09	\$648.08	\$619.28	55
4 - 9	8 - 18							PE8602	\$728.63	\$692.20	\$655.77	\$626.62	56
9 - 13	18 - 26							PE8603	\$728.70	\$692.27	\$655.83	\$626.68	57

*Field Replaceable Connectors

LIMITERS

High Rel



Frequency Range (GHz.)	Insertion Loss Max. (dB)	Input VSWR Typ.	Leakage Power Max. (dBm)	Recovery Time Typ. (ns)	Input Power (CW) Max. (W)	Peak Power Max. (W)	Limiting Threshold Typ. (dBm)	Model No	1	2-4	5-9	10+	ROW
20 MHz - 4	0.8	1.8:1	13	15,000	2	100	10	PE80L2003	\$1,252.27	\$1,202.18	\$1,152.09	\$1,102.00	58
500 MHz - 18	1.5	1.5:1	10	10	1		14	PE80L1000	\$3,981.43	\$3,822.17	\$3,662.92	\$3,503.66	59
	2	1.8:1	18	15,000	5		PE80L2005	\$1,739.45	\$1,669.87	\$1,600.29	\$1,530.72	60	
2 - 8	1	2:1	13	40	1	200	6	PE80L1001	\$4,801.17	\$4,609.12	\$4,417.08	\$4,225.03	61
2 - 18	2	2:1	14	100			PE80L2001	\$4,557.14	\$4,374.85	\$4,192.57	\$4,010.28	62	
		2:1		100			PE80L3000	\$4,721.47	\$4,532.61	\$4,343.75	\$4,154.89	63	
6 - 18	2.5	2:1	15	15,000	5	100	6	PE80L2006	\$1,465.17	\$1,406.56	\$1,347.96	\$1,289.35	64
8 - 12	1.2	1.8:1	18	12	10	100	15	PE80L2000	\$3,641.75	\$3,496.08	\$3,350.41	\$3,204.74	65
12 - 18	1.5	1.5:1	10	10	3		1	PE80L2004	\$1,441.43	\$1,383.77	\$1,326.12	\$1,268.46	66
18 - 40	4	2.1:1	12	10	1		20	5	PE80L4000	\$3,911.04	\$3,754.60	\$3,598.16	\$3,441.72
	4.5	3:1	13	15,000		100	6	PE80L2002	\$5,047.83	\$4,845.92	\$4,644.00	\$4,442.09	68
26.5 - 40	3	2:1	13	15,000	1	100	6	PE80L2007	\$2,114.75	\$2,030.16	\$1,945.57	\$1,860.98	69
								PE80L2008	\$1,799.20	\$1,727.23	\$1,655.26	\$1,583.30	70

PIN-PIN



Frequency Range (GHz.)	Limiting Threshold Typ. (dBm)	Leakage @1W CW Input Max. (dBm)	Insertion Loss Max. (dBm)	Input VSWR Typ.	In Power (CW) Max. (W)	In Peak Power Max. (W)	Model No	1 Pc. Price	See Web for Volume Pricing	ROW
500 MHz - 1	12	20	0.4	1.4:1	1	100	PE8017	\$488.87	See Web for Volume Pricing	71
500 MHz - 2		19	0.5	1.4:1			PE8018	\$503.82		72
1 - 2	9	19	0.2	1.2:1			PE8019	\$531.48		73
2 - 4	12	19	0.8	1.5:1			PE8020	\$469.72		74
2 - 8	9	16	1.2	1.6:1			PE8021	\$603.39		75
2 - 18	12	18	2.5	2.2:1			PE8022	\$608.41		76
4 - 8	9	16	1	1.3:1			PE8023	\$563.38		77
6 - 18	12	16	2.2	2:1			PE8024	\$586.93		78
7 - 12		16	1.8	1.8:1			PE8025	\$560.36		79
8 - 16		16	2	2:1			PE8026	\$533.67		80
11 - 18	9	16	2	2:1			PE8027	\$640.44		81

PIN-Schottky



Frequency Range (GHz.)	Limiting Threshold Typ. (dBm)	Leakage @1W CW Input Max. (dBm)	Insertion Loss Max. (dBm)	Input VSWR Typ.	In Power (CW) Max. (W)	In Peak Power Max. (W)	Model No	1 Pc. Price	See Web for Volume Pricing	ROW	
500 MHz - 1	12	14	0.5	1.4:1	1	100	PE8028	\$463.58	See Web for Volume Pricing	82	
500 MHz - 2	9	14	0.4	1.25:1		200	PE8029	\$512.36		83	
						100	PE8030	\$628.88		84	
1 - 2	4	14	0.6	1.4:1		200	PE8031	\$590.60		85	
2 - 4	9	14	1.2	1.4:1			PE8032	\$543.79		86	
2 - 8							PE8033	\$597.14		87	
2 - 18	4	18	2.5	2.2:1		100	PE8034	\$612.47		88	
4 - 8		13	1.4	1.5:1			PE8035	\$325.54		89	
6 - 18		13	2.5	2.2:1			PE8036	\$592.43		90	
7 - 12		16	1.6	1.6:1			200	PE8037		\$738.24	91
8 - 16		9	12	2				1.5:1			

See Our Website For Current Pricing & Real-Time Stock Availability!

Limiters & Detectors

DETECTORS

Biased Detectors



Frequency Range (GHz.)	Polarity	Voltage Sensitivity (mV/mW)	Flatness (dB)	Input Power (dBm)	TSS (dBm)	Model No	1 Pc. Price	See Web for Volume Pricing		R O W
500 MHz - 1	Negative	1,800	0.25	23	-54	PE8001	\$645.68	See Web for Volume Pricing		92
	Positive		0.5			PE8001-P	\$636.89			93
1 - 2	Negative	2,000	0.25			PE8002	\$488.87			94
	Positive		PE8002-P			\$801.52	95			
2 - 4	Negative		PE8003			\$714.49	96			
	Positive		PE8003-P			\$712.46	97			
4 - 8	Negative		PE8044		\$551.98	98				
	Positive		PE8004-P		\$546.85	99				
6 - 18	Negative	1,600	0.8		-52	PE8005	\$686.29			1
	Positive	PE8005-P	\$601.53			2				
8 - 12	Negative	1,800	0.5			PE8006	\$745.18			3
	Positive		PE8006-P			\$711.48	4			
8 - 16	Negative		PE8007	\$527.94		5				
	Positive		PE8007-P	\$677.09		6				
8 - 18	Negative		1,600	0.7	PE8008	\$628.88	7			
	Positive		PE8008-P	\$631.61	8					
18 - 26	Negative	1,500	1	PE8009	\$593.00	9				
	Positive			PE8009-P	\$764.30	10				

Finline Detectors



Frequency Range (GHz.)	Output Polarity	Input Power (dBm)	Video Output Typ. (V)	Voltage Sensitivity (mV/mW)	Model No	1	2-4	5-9	10+	R O W
100 MHz - 12.4	Positive	27	+10.5	800	PE80T1004	\$1,075.42	\$1,032.40	\$989.39	\$946.37	11
100 MHz - 18	Positive		+10		PE80T1005	\$1,277.81	\$1,226.70	\$1,175.59	\$1,124.47	12

Log Detectors



Frequency Range (GHz.)	Imp. (Ohm)	Slope (mV/dB)	Input Power Max. (dBm)	Output Voltage Max. (dB)	Slew Rate (V/us)	Model No	1-4	5-9	10-24	25+	R O W
10 MHz - 3	50	40	10	2	1	PE8040	\$554.22	\$526.51	\$498.80	\$476.63	13

Phase Detectors



Frequency Range (GHz.)	Input Power Max. (dBm)	VSWR Max.	DC Voltage	Model No	1	2-4	5-9	10+	R O W
3 MHz - 300 MHz	17	17	15	PE80T4000	\$1,335.99	\$1,282.55	\$1,229.11	\$1,175.67	14
5 MHz - 25 MHz				PE80T4002	\$1,116.44	\$1,071.78	\$1,027.12	\$982.47	15
200 MHz - 800 MHz	10	10		PE80T4001	\$1,461.56	\$1,403.10	\$1,344.64	\$1,286.17	16

Power Detectors



Frequency Range (GHz.)	Dynamic Range (dB)	True RMS Output Voltage Typ (V)	Output Slope	VSWR	Max RF Input Power (dBm)	RF Connectors	Model No	1	2-4	5-9	10+	ROW
30 MHz - 4	80	0.62 - 1.89	Positive	1.5:1	20	SMA Female	PE80P1001	\$684.74	\$643.66	\$609.42	\$582.03	17
50 MHz - 3	60	0.12 - 2.1		1.3:1	10		PE80P1002	\$684.74	\$643.66	\$609.42	\$582.03	18
50 MHz - 5	30	0.15 - 4.95		1.4:1	15		PE80P1000	\$684.74	\$643.66	\$609.42	\$582.03	19

Schottky Zero Bias Detectors



Frequency Range (GHz.)	Imp. (Ohm)	Polarity	Voltage Sensitivity (mV/mW)	VSWR Max	Video Capacitance (pF)	Signal Level & Level Min Input (dBm)	Model No	1 Pc. Price	See Web for Volume Pricing			ROW	
10 MHz - 2	50	Negative	500	1.2:1	470	-30	PE8010	\$617.93	See Web for Volume Pricing			20	
10 MHz - 4				1.3:1			PE8011	\$567.43				21	
10 MHz - 12.4				Positive			1.6:1	PE8012				\$539.24	22
							PE8012P	\$555.83				23	
10 MHz - 18		Negative	450	1.7:1	PE8012-P		Call	24					
10 MHz - 18.5				PE8012P3	\$857.92		25						
10 MHz - 26.5			500	1.45:1	20		PE8013	\$655.14				26	
2 - 4							PE8014	\$714.56				27	
2 - 8							PE8015	\$620.39				28	
							PE8016	\$628.88				29	

Threshold Detectors



Frequency Range (GHz.)	Imp. (Ohm)	Signal Level & Input Level Min. (dBm)	Input Power Max. (dBm)	Propagation Delay Typ. (ns)	DC Voltage	Model No	1	2-4	5-9	10+	ROW
2 - 18	50	-20	10	15	15	PE80T1000	\$4,382.77	\$4,207.46	\$4,032.15	\$3,856.84	30
		-45		20	12	PE80T1001	\$7,162.21	\$6,875.72	\$6,589.23	\$6,302.74	31
16 - 40		-20	17	15	PE80T1002	\$5,670.33	\$5,443.52	\$5,216.70	\$4,989.89	32	

Tunnel Diode Zero Bias Detectors



Frequency Range (GHz.)	Output Polarity	VSWR Max	Pulse Video Response Risettime Typ. (ns)	Voltage Sensitivity Typ. (mV/mW)	Flatness Max. (dB)	Input Power Max. (dBm)	Video Capacitance Typ. (pF)	Model No	1 Pc. Price	See Web for Volume Pricing			ROW					
100 MHz - 2	Negative	2:1	5	800	0.75	17	470	PE80T6000	\$481.40	See Web for Volume Pricing			33					
	Positive							PE80T6001	\$481.40				34					
100 MHz - 4	Negative	2.2:1						17	1,000				0.5	17	100	PE80T6002	\$510.00	35
	Positive															PE80T6003	\$510.00	36
500 MHz - 1	Negative	2:1						400	1				17	17	50	PE80T6010	\$383.33	37
	Positive															PE80T6011	\$383.33	38
500 MHz - 18	Negative	3.5:1		17	1,000	0.5	17	20	PE80T6004				\$1,163.33	39				
	Positive								PE80T6005				\$1,163.33	40				
1 - 2	Negative	2:1		17	1,000	0.5	17	50	PE80T6012				\$476.67	41				
	Positive								PE80T6013				\$476.67	42				
2 - 4	Negative	2.5:1	17	1,000	0.5	17	20	PE80T6014	\$490.00	43								
	Positive							PE80T6015	\$490.00	44								
2 - 6	Negative	2.5:1	17	1,000	0.5	17	20	PE80T6016	\$500.00	45								
	Positive							PE80T6017	\$500.00	46								
2 - 18	Negative	3.5:1	17	500	1	17	20	PE80T6006	\$704.37	47								
	Positive							PE80T6007	\$703.06	48								

Tunnel Diode Zero Bias Detectors



Frequency Range (GHz.)	Output Polarity	VSWR Max	Pulse Video Response Rise Time Typ. (ns)	Voltage Sensitivity Typ. (mV/mW)	Flatness Max. (dB)	Input Power Max. (dBm)	Video Capacitance Typ. (pF)	Model No	1-4	5-9	10-24	25+	ROW			
4 - 8	Negative	2.5:1	5	900	0.7	17	10	PE80T6018	\$529.89	\$503.40	\$476.90	\$455.71	49			
	Positive							PE80T6019	\$529.89	\$503.40	\$476.90	\$455.71	50			
6 - 12	Negative	2.7:1						800	0.6	17	PE80T6020	\$590.00	\$560.50	\$531.00	\$507.40	51
	Positive										PE80T6021	\$613.01	\$582.36	\$551.71	\$527.19	52
6 - 18	Negative	3:1						700	0.75	17	PE80T6008	\$656.67	\$623.84	\$591.00	\$564.74	53
	Positive										PE80T6009	\$682.28	\$648.17	\$614.05	\$586.76	54
12 - 18	Negative			0.7	17	PE80T6022					\$683.33	\$649.16	\$615.00	\$587.66	55	
	Positive					PE80T6023					\$709.98	\$674.48	\$638.98	\$610.58	56	
18 - 26	Negative			4:1	400	1		17	5	PE80T6024	\$793.33	\$753.66	\$714.00	\$682.26	57	
	Positive									PE80T6025	\$793.33	\$753.66	\$714.00	\$682.26	58	

NOISE SOURCES



Frequency Range (MHz.)	Design	Noise Output (ENR dB)	Connector	Model No	1	2-4	5-9	10+	ROW	
100 - 60,000	Calibrated	15.5	1.85mm Male	PE85N1009	\$17,714.00	\$17,005.44	\$16,296.88	\$15,588.32	59	
100 - 40,000			2.92mm Male	PE85N1008	\$8,336.31	\$8,002.86	\$7,669.41	\$7,335.95	60	
10 - 26,000			3.5mm Male	PE85N1007	\$5,272.93	\$5,062.01	\$4,851.10	\$4,640.18	61	
10 - 18,000	Calibrated		SMA Male	SMA Male	PE85N1006	\$3,771.19	\$3,620.34	\$3,469.49	\$3,318.65	62
2,000 - 4,000				PE8501	\$1,709.32	\$1,640.95	\$1,572.57	\$1,504.20	63	
8,000 - 12,000				PE8503	\$1,819.56	\$1,746.78	\$1,674.00	\$1,601.21	64	
12,000 - 18,000				PE8504	\$2,099.50	\$2,015.52	\$1,931.54	\$1,847.56	65	
1,000 - 2,000				PE8505	\$1,390.12	\$1,334.52	\$1,278.91	\$1,223.31	66	
2,000 - 4,000				PE8506	\$1,514.30	\$1,453.73	\$1,393.16	\$1,332.58	67	
4,000 - 8,000				PE8507	\$1,712.46	\$1,643.96	\$1,575.46	\$1,506.96	68	
8,000 - 12,000				PE8508	\$2,014.38	\$1,933.80	\$1,853.23	\$1,772.65	69	
12,000 - 18,000				PE8509	\$1,779.12	\$1,707.96	\$1,636.79	\$1,565.63	70	
1 - 2,000		Calibrated, Amplified, Bench Top		SMA Female	PE85N1017	\$16,564.36	\$15,901.79	\$15,239.21	\$14,576.64	71
10 - 3,000	PE85N1018		\$18,409.02		\$17,672.66	\$16,936.30	\$16,199.94	72		
0.01 - 2,000	Calibrated	SMA Female	PE85N1019	\$2,417.89	\$2,321.17	\$2,224.46	\$2,127.74	73		
10 - 6,000			PE85N1020	\$2,448.70	\$2,350.75	\$2,252.80	\$2,154.86	74		
1,000 - 18,000			PE85N1021	\$3,031.39	\$2,910.13	\$2,788.88	\$2,667.62	75		
3,700 - 4,200			PE85N1022	\$3,508.42	\$3,368.08	\$3,227.75	\$3,087.41	76		
7,200 - 8,400			PE85N1014	\$3,508.42	\$3,368.08	\$3,227.75	\$3,087.41	77		
10,700 - 12,700			PE85N1015	\$3,629.63	\$3,484.44	\$3,339.26	\$3,194.07	78		
0.01 - 2,000	Calibrated	SMA Female	PE85N1016	\$4,115.90	\$3,951.26	\$3,786.63	\$3,621.99	79		
0.1 - 500			PE85N1000	\$2,508.10	\$2,407.78	\$2,307.45	\$2,207.13	80		
10 - 2,000			PE85N1001	\$2,544.20	\$2,442.43	\$2,340.66	\$2,238.90	81		
10 - 3,000			PE85N1010	\$3,127.74	\$3,002.63	\$2,877.52	\$2,752.41	82		
10 - 2,000			Calibrated, Amplified	PE85N1011	\$3,284.00	\$3,152.64	\$3,021.28	\$2,889.92	83	
				PE85N1012	\$3,900.42	\$3,744.40	\$3,588.39	\$3,432.37	84	
10 - 6,000			Calibrated	PE85N1002	\$3,031.39	\$2,910.13	\$2,788.88	\$2,667.62	85	
				PE85N1003	\$3,428.72	\$3,291.57	\$3,154.42	\$3,017.27	86	
				PE85N1013	\$4,956.03	\$4,757.79	\$4,559.55	\$4,361.31	87	
1,000 - 18,000			Calibrated	PE85N1004	\$3,645.25	\$3,499.44	\$3,353.63	\$3,207.82	88	
	PE85N1005	\$3,789.23		\$3,637.66	\$3,486.09	\$3,334.52	89			

PHASE SHIFTERS AND TRIMMERS

Adjustable Phase Trimmers



Connector	Gender	Frequency Range (MHz.)	Deg. Phase Adjustment per GHz	Max. Insertion Loss (dB)	Model No	1-9	10-24	25-49	50+	ROW
SMA	Male	DC - 18,000	10	3.4	PE8203	\$193.12	\$183.46	\$173.81	\$166.08	90

8 Bit Programmable Phase Shifter



Connector	Gender	Frequency Range (MHz.)	Deg. Phase Adjustment per GHz	Max. Insertion Loss (dB)	Model No	1	2-4	5-9	10+	ROW
2.92mm	Female	32,000 - 37,000	13	12	PE82P5003	\$14,477.64	\$13,898.53	\$13,319.43	\$12,740.32	91
		500 - 2,000			PE82P5000	\$8,563.01	\$8,220.49	\$7,877.97	\$7,535.45	92
		6,000 - 18,000			PE82P5002	\$14,723.68	\$14,134.73	\$13,545.79	\$12,956.84	93
		8,500 - 11,000			PE82P5001	\$9,053.03	\$8,690.91	\$8,328.79	\$7,966.67	94

Adjustable Phase Shifter



Connector	Gender	Frequency Range (MHz.)	Deg. Phase Adjustment per GHz	Max. Insertion Loss (dB)	Model No	1 Pc. Price	See Web for Volume Pricing			ROW
2.92mm	Female	18,000 - 40,000	60	2.5	PE82P1000	\$2,842.79	See Web for Volume Pricing			95
		DC - 2,300			PE8243	\$905.52				96
		DC - 4,300			PE8244	\$1,068.59				97
		DC - 8,200			PE8245	\$1,051.34				98
		DC - 12,700			PE8246	\$1,151.24				99
		DC - 18,000			PE8247	\$1,183.89				1
		18,000 - 26,500			PE8255	\$1,537.34				2
					PE8253	\$1,298.75				3

Analog Phase Shifter



Connector	Gender	Frequency Range (MHz.)	Deg. Phase Adjustment per GHz	Max. Insertion Loss (dB)	Model No	1	2-4	5-9	10+	ROW
SMA	Female	5,000 - 18,000	40	12	PE82P2000	\$5,940.99	\$5,703.35	\$5,465.71	\$5,228.07	4
		6,000 - 15,000	120	10	PE82P2001	\$5,491.06	\$5,271.42	\$5,051.78	\$4,832.13	5

POWER DIVIDERS

50 Ohm



Ports	Freq. Range (MHz.)	Connector	Gender	Maximum Power (W)	Model No	1-9	10-24	25-49	50+	ROW
2 WAY	Female	350-6,000	SMA	30	PE20DV1053	\$277.07	\$263.22	\$249.36	\$238.28	6

See Our Website For Current Pricing & Real-Time Stock Availability!

Phase Shifters & Trimmers
Power Dividers & RF Combiners



Technical Support
(866) 727-8376



Same-Day Shipping,
Even Custom Cable Assemblies

50 Ohm



Ports	Freq. Range (MHz.)	Connector	Gender	Maximum Power (W)	Model No	1 Pc. Price	See Web for Volume Pricing			ROW		
2 WAY	Female	2,000-18,000	N	30	PE20DV1049	\$619.94	See Web for Volume Pricing			7		
			SMA		PE20DV1044	\$332.48				8		
					PE20DV1045	\$131.61				9		
4 WAY	Female	1,000-4,000	N	30	PE20DV1051	\$306.67				10		
			SMA		PE20DV1046	\$193.95				11		
					PE20DV1047	\$193.95				12		
					PE20DV1048	\$443.31				13		
					PE20DV1050	\$436.38				14		
8 WAY	Female	5-500	N	10	PE20DV1052	\$512.57						

Resistive



Ports	Freq. Range (MHz.)	Connector	Gender	Maximum Power	Model No	1 Pc. Price	See Web for Volume Pricing			ROW
2 WAY	Male	0-6,000	SMA	2	PE2082	\$310.42	See Web for Volume Pricing			16
			2.92mm		PE2063	\$475.74				17
			SMA		PE2067	\$459.24				18
			2.92mm		PE2064	\$551.27				19
			N		PE2066	\$512.88				20
	Female	0-18,000	SMA	1	PE2068	\$504.01				21
					PE2084	\$340.47				22
					PE2065	\$725.44				23
	Male	0-26,500	2.92mm		PE2083	\$693.88				24
	Female									

Reactive



Ports	Freq. Range (MHz.)	Connector	Gender	Maximum Power (W)	Model No	1 Pc. Price	See Web for Volume Pricing			ROW				
2 WAY	Female	2-500	BNC	1	PE2000	\$241.30	See Web for Volume Pricing			25				
			N	1	PE2044	\$523.87				26				
			SMA	1	PE2070	\$463.64				27				
			N	1	PE2047	\$518.46				28				
			Male	10-1,000	7/16 DIN					3	PE20DV1041	\$195.60	29	
										10	PE2032	\$605.78	30	
				500-1,000	SMA						30	PE20DV019	\$121.86	31
											20	PE20DV009	\$217.70	32
											20	PE20DV008	\$110.99	33
											30	PE20DV014	\$121.86	34
	20	PE20DV013									\$217.70	35		
	30	PE20DV016									\$121.86	36		
	30	PE20DV000									\$268.40	37		
	20	PE20DV005									\$378.77	38		
	30	PE2028	\$586.73	39										
	10	PE2081	\$393.41	40										
	Female	7,000-12,400	N		10	PE2036				\$681.48	41			
					10	PE2078				\$1,968.02	42			
		10,000-40,000	2.92mm			12				PE2077	\$1,745.17	43		
						10				PE2079A	\$2,165.06	44		
10						PE2037	\$977.80	45						
10						PE2037	\$977.80	45						
3 WAY	Female	376-2,200	N	500	PE20DV1040	\$267.75	46							
					SMA	30	PE20DV017	\$199.80	47					
						30	PE20DV001	\$335.87	48					

Reactive



Ports	Freq. Range (MHz.)	Connector	Gender	Maximum Power (W)	Model No	1 Pc. Price	See Web for Volume Pricing	R O W
4 WAY	Female	2-500	BNC	1	PE2001	\$431.94	See Web for Volume Pricing	49
			N	1	PE2045	\$781.49		50
		10-1,000	BNC	1	PE2004	\$688.44		51
			N	10	PE2038	\$958.73		52
		500-1,000	SMA	30	PE20DV020	\$193.67		53
				30	PE20DV010	\$232.65		54
		800-2,500	SMA	20	PE20DV012	\$138.20		55
				10	PE2039	\$1,002.07		56
		1,000-2,000	SMA	30	PE20DV015	\$193.67		57
				30	PE2040	\$961.88		58
2,000-4,000	SMA	30	PE20DV018	\$186.40	59			
		30	PE20DV002	\$341.06	60			
2,000-8,000	SMA	30	PE20DV006	\$799.76	61			
		30	PE2043	\$817.25	62			
12,000-18,000	SMA	30	PE2024	\$728.92	63			
		1	PE2006	\$615.68	64			
6 WAY	Female	1-175	BNC	1	PE2006	\$615.68	See Web for Volume Pricing	64
		2,000-8,000	SMA	30	PE20DV003	\$459.64		65
8 WAY	Female	2-500	BNC	1	PE2002	\$903.93	See Web for Volume Pricing	66
			SMA	30	PE20DV011	\$287.39		67
				30	PE20DV004	\$632.75		68
12 WAY	Female	2-500	BNC	1	PE2005	\$827.96		69

Wilkinson



Ports	Freq. Range (MHz.)	Connector	Gender	Maximum Power (W)	Model No	1 Pc. Price	See Web for Volume Pricing	R O W
2 WAY	Female	10-1,000	BNC	1	PE2003	\$456.12	See Web for Volume Pricing	70
			SMA	10	PE2008	\$405.10		71
				30	PE20S0022	\$409.11		72
		500-2,000	SMA	10	PE2092	\$135.87		73
				10	PE2088	\$115.45		74
		690-2,700	SMA	50	PE20S0025	\$439.12		75
				10	PE2074	\$275.99		76
		800-2,500	SMA	50	PE2033	\$630.01		77
				10	PE2011	\$349.37		78
		1,000-2,000	SMA	10	PE2034	\$561.60		79
				10	PE2014	\$293.62		80
		2,000-4,000	SMA	10	PE2026	\$425.56		81
				30	PE2035	\$659.39		82
		2,000-8,000	N	10	PE2080	\$403.86		83
				10	PE2020	\$386.17		84
Male	4,000-8,000	SMA	10	PE2027	\$663.63	85		
			10	PE2023	\$422.45	86		
			10	PE2027	\$663.63	87		
3 WAY	Female	2-200	BNC	1	PE2007	\$412.68	See Web for Volume Pricing	87
			N	10	PE2093	\$218.27		88
		SMA	10	PE2090	\$205.90	89		
			30	PE20DV1034A	\$295.92	90		
		698-2,700	N	50	PE20S0019	\$490.41		91
4 WAY	Female	800-2,500	SMA	30	PE2009	\$505.13	See Web for Volume Pricing	92
				30	PE20S0024	\$436.35		93
		500-1,000	N	10	PE2094	\$255.44		94
				10	PE2089	\$226.92		95
		500-2,000	SMA	30	PE20S0020	\$413.18		96
				10	PE2012	\$519.50		97
		690-2,700	SMA	30	PE2031	\$597.41		98
				10	PE2029	\$1,114.34		99
4,000-8,000	N	10	PE2041	\$861.86	1			
7,000-12,400	SMA	10	PE2021	\$519.70	2			

Wilkinson



Ports	Freq. Range (MHz.)	Connector	Gender	Maximum Power (W)	Model No	1 Pc. Price	See Web for Volume Pricing			R O W
8 WAY	Female	500-2,000	SMA	30	PE20S0023	\$567.64	See Web for Volume Pricing			3
		690-2,700	N	10	PE2095	\$419.60				4
		698-2,700	SMA	10	PE2091	\$287.46				5
		800-2,500	N	30	PE20DV1038A	\$685.67				6
			SMA	30	PE20S0021	\$701.98				7

75 Ohm

Reactive



Ports	Freq. Range (MHz.)	Connector	Gender	Maximum Power (W)	Model No	1 Pc. Price	See Web for Volume Pricing			R O W
2 WAY	Female	2-500	BNC	1	PE2048	\$489.33	See Web for Volume Pricing			8
		10-1,000		1	PE2062	\$242.00				9
4 WAY	Female	2-500	BNC	1	PE2049	\$439.07				10
8 WAY	Female	2-500	BNC	1	PE2061	\$735.95				11

RF COMBINERS

Broadband



Frequency Range (GHz)	Ports	Connector 1	Connector 2	Power Rating	Isolation (dB)	Model No	1 Pc. Price	See Web for Volume Pricing			R O W
20 MHz - 1	2	N Female	N Female	500 W	10	PE20S0004	\$2,327.19	See Web for Volume Pricing			12
		SMA Female	SMA Female	100 W	15	PE20S0001	\$1,183.40				13
80 MHz - 1	4	N Female	N Female	300 W	12	PE20S0003	\$2,338.50				14
		SMA Female	SMA Female	200 W		PE20S0002	\$1,637.54				15
500 MHz - 2.5	2	SMA Female	N Female	500 W	-12	PE20S0006	\$2,432.04				16
			SMA Female	200 W		PE20S0005	\$1,637.54				17
800 MHz - 2.5	2	N Female	N Female	600 W	13	PE20S0007	\$1,684.20				18
			SC Female	800 W		PE20S0011	\$2,188.84				19
800 MHz - 4.2	4	SMA Female	N Female	600 W	8	PE20S0010	\$2,236.20				20
			N Female	200 W		PE20S0009	\$2,385.27				21
1 - 6	2	SMA Female	SMA Female	200 W	12	PE20S0008	\$1,927.41				22
			N Female	200 W		PE20S0012	\$2,218.33				23
2 - 6	4	SMA Female	N Female	200 W	8	PE20S0013	\$2,180.39				24
			SMA Female	100 W		PE20S0014	\$1,825.76				25
2 - 6	2	SMA Female	N Female	100 W	12	PE20S0015	\$819.94				26
			N Female	400 W		PE20S0017	\$2,444.90				27
			SMA Female	100 W	10	PE20S0016	\$994.95	28			

ROTARY JOINTS



Connector A	Connector B	Max. Frequency (MHz.)	Input Power	VSWR	Model No	1-9	10-24	25-49	50+	R O W
2.92mm	2.92mm	DC - 18,000	30 WATT	1.4:1	PE1400	\$175.49	\$166.72	\$157.94	\$150.92	29
					PE1402	\$163.79	\$157.24	\$152.32	\$149.05	30
SMA	PCB	DC - 6,000		1.15:1	PE1401	\$146.24	\$138.93	\$131.62	\$125.77	31

SURGE PROTECTORS

In-Line Surge Protectors



See Our Website For Current Pricing & Real-Time Stock Availability!

Impedance	Connector	Gender	Frequency Range (MHz.)	Mount Type	Maximum Power	Model No	1 Pc. Price	See Web for Volume Pricing	ROW	
50 Ohm	4.3-10	Female to Female	698 - 2,700	Bulkhead	500 Watt	PE73SP1051	\$153.77	See Web for Volume Pricing	32	
		Female to Male		PE73SP1061		\$173.84	33			
		Male to Female		PE73SP1062		\$173.84	34			
	7/16 DIN	Female to Female	100 - 512	None	750 Watt	PE73SP1037	\$168.32		35	
			698 - 2,700	Bulkhead	1000 Watt	PE73SP1004	\$147.86		36	
			800 - 2,250	Bulkhead	500 Watt	PE73SP1063	\$111.52		37	
			698 - 2,160		1000 Watt	PE73SP1008	\$159.06		38	
		Female to Male	698 - 2,700	500 Watt	PE73SP1006	\$147.28	39			
				500 Watt	PE73SP1007	\$159.06	40			
		Male to Female	100 - 512	None	750 Watt	PE73SP1034	\$168.32		41	
				800 - 2,250	None	300 Watt	PE73SP1017		\$153.11	42
		N	Female to Female	DC - 2,400	Bulkhead	50 Watt	PE73SP1040		\$83.38	43
						2000 Watt	PE7301-4		\$188.53	44
				DC - 3,000	None	200 Watt	PE7301-1		\$168.23	45
					Bulkhead	200 Watt	PE7301-3		\$181.44	46
					None	2000 Watt	PE7301-2		\$174.94	47
				DC - 7,000	Bulkhead	40 Watt	PE73SP1039		\$64.80	48
	90 Watt					PE73SP1038	\$49.56		49	
	1.5 - 700			None	2000 Watt	PE73SP1021	\$70.22		50	
					2000 Watt	PE73SP1025	\$70.22		51	
	10 - 1,000			Bulkhead	3000 Watt	PE73SP1030	\$84.94		52	
			500 Watt		PE73SP1027	\$114.51	53			
	40 - 400		None	1500 Watt	PE73SP1024	\$77.43	54			
				100 Watt	PE73SP1015	\$161.42	55			
	Female to Male		100 - 512	Bulkhead	750 Watt	PE73SP1018	\$161.42		56	
					750 Watt	PE73SP1033	\$117.82		57	
			125 - 1,000	Bulkhead	200 Watt	PE73SP1035	\$117.82		58	
					200 Watt	PE73SP1029	\$114.51		59	
			400 - 1,200	Bulkhead	500 Watt	PE73SP1022	\$84.94		60	
					300 Watt	PE73SP1019	\$141.39		61	
			698 - 2,700	Bulkhead	300 Watt	PE73SP1000	\$105.61		62	
		500 Watt			PE73SP1065	\$95.37	63			
		800 - 2,250	None	300 Watt	PE73SP1010	\$141.39	64			
				300 Watt	PE73SP1013	\$141.39	65			
	Female to Male	2,000 - 6,000	Bulkhead	300 Watt	PE73SP1014	\$141.39	66			
				10 Watt	PE73SP1050	\$107.59	67			
		DC - 2,400	Bulkhead	10 Watt	PE73SP1048	\$61.21	68			
				50 Watt	PE73SP1042	\$83.38	69			
		DC - 7,000	Bulkhead	90 Watt	PE73SP1041	\$49.56	70			
				500 Watt	PE73SP1001	\$105.61	71			
		698 - 2,700	Bulkhead	500 Watt	PE73SP1002	\$116.73	72			
				500 Watt	PE73SP1003	\$121.43	73			
		2,000 - 6,000	None	10 Watt	PE73SP1049	\$61.21	74			
				1500 Watt	PE73SP1028	\$77.43	75			
	Male to Female	100 - 512	Bulkhead	750 Watt	PE73SP1036	\$117.82	76			
				375 Watt	PE73SP1023	\$70.22	77			
		125 - 1,000	Bulkhead	500 Watt	PE73SP1031	\$84.94	78			
				500 Watt	PE73SP1066	\$95.37	79			
	800 - 2,250	None	300 Watt	PE73SP1011	\$141.39	80				
			300 Watt	PE73SP1069	\$44.06	81				
SMA	Female RP to Male RP	DC - 5,800				PE73SP1068	\$44.06	82		
	Female to Female					PE73SP1067	\$44.06	83		
TNC	Female to Male	800 - 2,500	None	300 Watt	PE73SP1016	\$141.39	84			
UHF	Female to Female	1.5 - 700	Bulkhead	2000 Watt	PE73SP1026	\$74.75	85			
					PE73SP1032	\$82.05	86			

Surge Protectors

Surge Protector Replacement Cartridges

Cartridge For	Maximum Power	Model No	1-24	25-49	50-99	100+	ROW
PE7301	2,000 Watt	PE7301-2000CART	\$30.09	\$28.59	\$27.08	\$25.88	90
	200 Watt	PE7301-200CART	\$33.44	\$31.77	\$30.10	\$28.76	91
PE7139 & PE7140	1,500 Watt	PE7139-CART	\$20.37	\$19.56	\$18.94	\$18.54	92

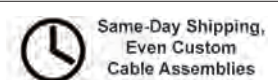

INDEX GUIDE TO SWITCHES

SWITCHES.....	288
ELECTROMECHANICAL RELAY SWITCHES.....	288
1M Life Cycles.....	288
2M Life Cycles.....	291
2.5M Life Cycles.....	292
5M Life Cycles.....	293
10M Life Cycles.....	294
Special Applications.....	294
GaN HIGH POWER SWITCHES.....	299
HIGH ISOLATION SWITCHES.....	299
HIGH ISOLATION USB SWITCHES.....	299
MANUAL SWITCHES.....	295
PIN DIODE SWITCHES.....	295
SPST.....	295
SPDT.....	295
SP3T.....	296
SP4T.....	297
SP5T.....	298
SP6T.....	298
SP8T.....	298
SP12T.....	298
Transfer.....	298
SMT PACKAGED ELECTROMECHANICAL SWITCHES.....	294

Electromechanical Relay Switches

1M Life Cycles



Features:
A: Absorptive
AR: Auto Reset
F: Failsafe
D: Diode
GR: Global Reset
H: Hot Switches
I: Indicators
L: Latching
NO: Normally Open
NT: Non-Terminated
P: Pulse
Latching
R: Reflective
RS: Reset
S: Self Cut Off
T: Terminated
TTL: TTL Logic

Max Frequency (GHz)	Switch Type	Connector Type	Features	Min Isolation (dB)	Max IL (dB)	Voltage (V)	RF Power (W CW)	Model No	1 Pc. Price	See Web for Volume Pricing	R O W
8 GHz	SP6T	TNC Female	NO/NT	60	0.6	28	50	PE71S6207	\$1,823.50	See Web for Volume Pricing	1
				70		12		PE71S6206	\$1,823.50		2
10 GHz	SPDT	TNC Female	F/I, TTL, D, NT	60	0.6	12	50	PE71S6200	\$1,094.10		3
						28		PE71S6201	\$1,094.10		4
			12			PE71S6198		\$920.24	5		
			28			PE71S6199		\$1,362.64	6		
	SP4T	N Female	NO/I, TTL, D, NT	60	0.6	12	160	PE71S6184	\$1,735.98		7
						28		PE71S6185	\$1,735.98		8
						12		PE71S6193	\$2,942.86		9
						28		PE71S6190	\$2,298.88		10
						12		PE71S6183	\$1,336.89		11
						28		PE71S6191	\$1,713.82		12
	SP6T	N Female	NO/I, TTL, D, NT	60	0.6	12	50	PE71S6188	\$1,984.48		13
						160		PE71S6196	\$2,344.50		14
						28		PE71S6189	\$1,909.99		15
						160		PE71S6197	\$2,435.94		16
12						PE71S6186		\$1,579.68	17		
160						PE71S6194		\$1,875.60	18		
10 GHz	SPDT	N Female	NO/NT	60	0.6	12	50	PE71S6187	\$1,579.68		19
28						PE71S6195		Call	20		
12.4 GHz	SPDT	N Female	F/I, TTL, D, NT	60	0.6	12	45	PE71S6152	\$1,118.37	21	

Switches

1M Life Cycles



Features:
 A: Absorptive
 AR: Auto Reset
 F: Failsafe
 D: Diode
 GR: Global Reset

H: Hot Switches
 I: Indicators
 L: Latching
 NO: Normally Open
 NT: Non-Terminated
 P: Pulse

Latching Reflective
 R: Reflective
 RS: Reset
 S: Self Cut Off
 T: Terminated
 TTL: TTL Logic

Max Frequency (GHz)	Switch Type	Connector Type	Features	Min Isolation (dB)	Max IL (dB)	Voltage (V)	RF Power (W CW)	Model No	1 Pc. Price	See Web for Volume Pricing	ROW			
12.4 GHz	SPDT	N Female	F/I, TTL, D, NT	60	0.6	12	160	PE71S6160	\$1,280.76	See Web for Volume Pricing	23			
						28		PE71S6161	\$1,280.76		24			
					0.5	12	200	PE71S6059	\$627.58		25			
			28				PE71S6058	\$724.13	26					
			0.6		F/NT	12	50	PE71S6150	\$703.71		27			
							160	PE71S6158	\$974.37		28			
						28	50	PE71S6151	\$703.71		29			
			Transfer		N Female	L/I, TTL, D, S, NT	60	0.5	12		50	PE71S6156	\$1,353.30	30
									160		PE71S6164	\$1,515.69	31	
								28	50		PE71S6157	\$1,302.50	32	
						160			PE71S6165		\$1,458.80	33		
						0.6		L/S, D, NT	12		50	PE71S6154	\$1,172.50	34
	160	PE71S6162		\$1,364.12							35			
	28	50		PE71S6155					\$1,128.49		36			
	Transfer	TNC Female		F/I, TTL, D, NT		60		0.4	12		50	PE71S6168	\$1,578.63	37
											160	PE71S6176	\$1,840.48	38
								28	50		PE71S6169	\$1,642.37	39	
				160					PE71S6177		\$1,771.40	40		
				0.6				F/NT	12		50	PE71S6166	\$1,276.45	41
			160		PE71S6174		\$1,550.34				42			
			28		50		PE71S6167		\$1,327.32		43			
			Transfer	TNC Female	L/I, TTL, S, D, NT		60	0.4	12		50	PE71S6172	\$1,964.99	44
											160	PE71S6180	\$2,225.91	45
								28	50		PE71S6173	Call	46	
160					PE71S6181				\$2,142.36	47				
0.6					L/S, D, NT			12	50	PE71S6170	\$1,655.74	48		
	160	PE71S6178				\$1,891.23			49					
	28	50				PE71S6171		\$1,720.31	50					
18 GHz	SPDT	SMA Female			F/I, TTL, D, NT	70		0.6	12	50	PE71S6179	\$1,966.08	51	
										160	PE71S6204	\$1,528.62	52	
								28	50	PE71S6205	\$1,695.42	53		
					160				PE71S6202	\$1,354.60	54			
					0.4			F/NT	12	50	PE71S6203	\$1,407.43	55	
			160	PE71S6206			\$1,528.62			56				
	28	50	PE71S6207	\$1,407.43			57							
	Transfer	SMA Female	F/NT	60	0.4		12	20	PE71S6326	\$322.68	58			
								28	PE71S6327	\$340.14	59			
					0.5		P/I, H, NT	24	35	PE71S6328	\$674.31	60		
			28						PE71S6329	\$674.31	61			
			35					PE71S6330	\$674.31	62				
22 GHz			SPDT		SMA Female	F/T	60	0.6	20	12	PE71S6293	\$1,237.14	63	
	28	PE71S6294								\$1,096.72	64			
	12	PE71S6295								\$1,370.63	65			
	F/TTL, I, T	28				PE71S6296				\$2,008.73	66			
						12				PE71S6299	Call	67		
		L/S, D, TTL, I, T				28				PE71S6300	\$1,476.16	68		
	12		PE71S6297		\$1,877.13					69				
	L/S, D, TTL, T		28	PE71S6298	\$1,389.33	70								
		12		PE71S6307	\$2,573.74	71								
		SP4T	SMA Female	L/I, TTL, S, D, T	60	0.6				28	28	PE71S6308	\$2,365.34	72
	12										PE71S6305	\$2,392.63	73	
	L/S, D, T										28	PE71S6306	\$2,302.82	74
12				PE71S6309			\$2,302.82	75						
28				L/S, D, T			28	PE71S6310	\$2,302.82		76			
	12							PE71S6311	\$2,302.82		77			
	28	PE71S6312	\$2,302.82				78							

See Our Website For Current Pricing & Real-Time Stock Availability!

Switches

1M Life Cycles



Features:
 A: Absorptive
 AR: Auto Reset
 F: Failsafe
 D: Diode
 GR: Global Reset

H: Hot Switches
 I: Indicators
 L: Latching
 NO: Normally Open
 NT: Non-Terminated
 P: Pulse
 Latching
 R: Reflective
 RS: Reset
 S: Self Cut Off
 T: Terminated
 TTL: TTL Logic

Max Frequency (GHz)	Switch Type	Connector Type	Features	Min Isolation (dB)	Max IL (dB)	Voltage (V)	RF Power (W CW)	Model No	1 Pc. Price	See Web for Volume Pricing	ROW
22 GHz	SP4T	SMA Female	NO/I, T	60	0.6	28	20	PE71S6302	\$1,927.10	See Web for Volume Pricing	74
			NO/I, TTL, D, NT					PE71S6128	\$1,524.55		75
			NO/I, TTL, D, T					PE71S6129	\$1,424.80		76
			NO/NT					PE71S6303	\$2,522.55		77
			NO/T					PE71S6304	\$2,427.86		78
			L/I, TTL, S, D, T					PE71S6126	\$1,254.98		79
	SP6T		L/S, D, T					PE71S6127	\$1,291.33		80
			NO/I, TTL, D, NT					PE71S6301	\$1,927.10		81
			NO/I, TTL, D, T					PE71S6315	\$3,049.13		82
			NO/NT					PE71S6316	\$3,049.13		83
			NO/T					PE71S6313	\$2,761.30		84
			NO/I, TTL, D, NT					PE71S6314	\$2,761.30		85
			NO/I, TTL, D, T					PE71S6132	\$1,823.03		86
			NO/NT					PE71S6133	\$1,696.11		87
			NO/T					PE71S6311	\$2,774.85		88
								PE71S6312	\$2,774.85		89
								PE71S6130	\$1,544.59		90
								PE71S6131	\$1,443.53		91
26.5 GHz	SPDT	SMA Female	F/NT	50	0.5	12	20	PE71S6094	\$412.38	See Web for Volume Pricing	94
			F/TTL, D, I, NT					PE71S6328	Call		95
			L/I, TTL, S, D, NT					PE71S6096	\$742.15		96
			L/S, D, NT					PE71S6097	\$553.02		97
								PE71S6100	\$1,263.33		98
								PE71S6101	\$912.92		99
	Transfer		F/I, TTL, D, NT					PE71S6098	\$561.09		1
			F/NT					PE71S6099	\$582.97		2
			L/I, TTL, S, D, NT					PE71S6112	\$1,095.82		3
			L/S, D, NT					PE71S6113	\$1,065.59		4
								PE71S6110	\$757.10		5
								PE71S6111	\$805.42		6
								PE71S6116	\$1,265.59		7
								PE71S6117	\$1,406.99		8
40 GHz	SPDT	2.92mm Female	F/I, TTL, D, NT	50	0.8	12	10	PE71S6104	\$2,918.17		11
			F/NT					PE71S6105	\$2,715.01		12
			L/I, TTL, S, D, NT					PE71S6102	\$2,089.95		13
			L/S, D, NT					PE71S6103	\$2,089.95		14
								PE71S6108	\$3,666.43		15
	SP4T		L/S, D, NT	PE71S6109		\$3,923.09	16				
			L/I, TTL, S, D, NT	PE71S6106		\$3,086.54	17				
			L/I, TTL, S, D, T	PE71S6107		\$2,970.68	18				
			L/S, D, RS, T	PE71S6141		\$6,390.95	19				
			L/S, D, T	PE71S6140		\$6,916.87	20				
40 GHz				50	1	12	3	PE71S6319	\$7,960.88	21	
40 GHz											PE71S6320
								PE71S6318	\$7,224.53		23
								PE71S6317	\$7,224.53		24

1M Life Cycles



Features:
 A: Absorptive
 AR: Auto Reset
 F: Failsafe
 D: Diode
 GR: Global Reset
 H: Hot Switches
 I: Indicators
 L: Latching
 NO: Normally Open
 NT: Non-Terminated
 P: Pulse
 R: Latching Reflective
 RS: Reset
 S: Self Cut Off
 T: Terminated
 TTL: TTL Logic

Max Frequency (GHz)	Switch Type	Connector Type	Features	Min Isolation (dB)	Max IL (dB)	Voltage (V)	RF Power (W CW)	Model No	1	2-4	5-9	10+	ROW				
40 GHz	SP4T	2.92mm Female	L/S, RS, D, NT	50	0.9	12	3	PE71S6138	\$5,783.10	\$5,551.78	\$5,320.45	\$5,089.13	25				
								PE71S6139	\$5,783.10	\$5,551.78	\$5,320.45	\$5,089.13	26				
								PE71S6136	\$4,421.33	\$4,244.48	\$4,067.62	\$3,890.77	27				
								PE71S6137	\$4,274.56	\$4,103.58	\$3,932.60	\$3,761.61	28				
			SP6T	2.92mm Female	NO/I, TTL, D, NT	50	0.9	12	3	PE71S6134	\$2,952.35	\$2,834.26	\$2,716.16	\$2,598.07	29		
										PE71S6135	\$3,067.49	\$2,944.79	\$2,822.09	\$2,699.39	30		
										PE71S6148	\$7,120.35	\$6,835.54	\$6,550.72	\$6,265.91	31		
										PE71S6149	\$7,120.35	\$6,835.54	\$6,550.72	\$6,265.91	32		
					Transfer	2.92mm Female	L/S, I, RS, T	60	1	12	5	PE71S6321	\$8,012.98	\$7,692.46	\$7,371.94	\$7,051.42	33
												PE71S6322	\$8,012.98	\$7,692.46	\$7,371.94	\$7,051.42	34
												PE71S6146	\$6,460.40	\$6,201.98	\$5,943.57	\$5,685.15	35
												PE71S6147	\$6,712.36	\$6,443.87	\$6,175.37	\$5,906.88	36
	L/S, RS, D, NT	50					0.9	12	1	5	PE71S6323	\$8,770.18	\$8,419.37	\$8,068.57	\$7,717.76	37	
											PE71S6324	\$6,133.92	\$5,919.23	\$5,704.55	\$5,520.53	38	
											PE71S6144	\$6,985.71	\$6,706.28	\$6,426.85	\$6,147.42	39	
											PE71S6145	\$5,105.80	\$4,901.57	\$4,697.34	\$4,493.10	40	
	NO/I, TTL, D, NT	60	0.9	12	1	5	PE71S6142	\$3,369.15	\$3,234.38	\$3,099.62	\$2,964.85	41					
							PE71S6143	\$3,500.55	\$3,360.53	\$3,220.51	\$3,080.48	42					
							PE71S6120	\$3,781.78	\$3,630.51	\$3,479.24	\$3,327.97	43					
							PE71S6121	\$3,518.50	\$3,377.76	\$3,237.02	\$3,096.28	44					
	F/I, TTL, D, NT	50	0.9	12	1	5	PE71S6119	\$2,742.62	\$2,632.92	\$2,523.21	\$2,413.51	45					
							PE71S6124	\$5,016.09	\$4,815.45	\$4,614.80	\$4,414.16	46					
							PE71S6125	\$5,016.09	\$4,815.45	\$4,614.80	\$4,414.16	47					
							PE71S6122	\$3,243.26	\$3,113.53	\$2,983.80	\$2,854.07	48					
L/S, D, NT	50	0.9	12	1	5	PE71S6123	\$3,121.52	\$2,996.66	\$2,871.80	\$2,746.94	49						

2M Life Cycles



Features:
 A: Absorptive
 AR: Auto Reset
 F: Failsafe
 D: Diode
 GR: Global Reset
 H: Hot Switches
 I: Indicators
 L: Latching
 NO: Normally Open
 NT: Non-Terminated
 P: Pulse
 R: Latching Reflective
 RS: Reset
 S: Self Cut Off
 T: Terminated
 TTL: TTL Logic

Max Frequency (GHz)	Switch Type	Connector Type	Features	Min Isolation (dB)	Max IL (dB)	Voltage (V)	RF Power (W CW)	Model No	1 Pc. Price	See Web for Volume Pricing	ROW	
3 GHz	SPDT	SMA Female	L/NT	30		12		PE71S8001	\$465.44			
	SP4T							PE71S8002	\$586.99			
12 GHz	SPDT	N Female	F/NT	70	0.5	12	200	PE71S6348	\$696.76	See Web for Volume Pricing		
								PE71S6398	\$420.10			
								PE71S6397	\$420.10			
	Transfer			60	0.7	28	120	PE71S6385	\$1,028.38			
								PE71S6403	\$752.80			
								PE71S6386	\$1,138.81			
12.4 GHz	SP6T	N Female	L/I, RS, NT	60	0.5	12	200	PE71S6072	\$3,571.79			
	SP12T	SMA Female	L/S, AR, I, D, T					60	0.6			28
18 GHz	SPDT	SMA Female	F/I, NT	65	0.35	12	60			PE71S6351	\$336.81	
								F/NT	PE71S6347	\$266.90		
									PE71S6392	\$267.30		
			F/T	60	0.5	28	100		PE71S6391	\$267.30		
								PE71S6060	\$1,125.62			
								PE71S6354	\$1,140.79			

See Our Website For Current Pricing & Real-Time Stock Availability!

Switches

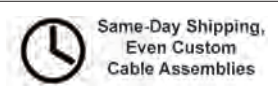
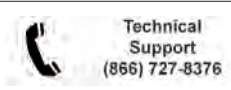

2M Life Cycles



Features:
 A: Absorptive
 AR: Auto Reset
 F: Failsafe
 D: Diode
 GR: Global Reset
 H: Hot Switches
 I: Indicators
 L: Latching
 NO: Normally Open
 NT: Non-Terminated
 P: Pulse
 Latching
 R: Reflective
 RS: Reset
 S: Self Cut Off
 T: Terminated
 TTL: TTL Logic

Max Frequency (GHz)	Switch Type	Connector Type	Features	Min Isolation (dB)	Max IL (dB)	Voltage (V)	RF Power (W CW)	Model No	1 Pc. Price	See Web for Volume Pricing	ROW	
18 GHz	SPDT	SMA Female	F/T	65	0.35	28	60	PE71S6355	\$1,185.28	See Web for Volume Pricing	67	
								PE71S6404	\$1,051.46		68	
			F/TTL, NT	60	0.5	28	100	PE71S6350	\$408.60		69	
			L/I, S, T					PE71S6062	\$1,461.80		70	
			L/I, T					PE71S6061	\$1,287.01		71	
	L/TTL, T		PE71S6063	\$1,408.27	72							
	SP4T		SMA Female	NO/NT	80	0.4	12	60	PE71S6363		\$1,127.30	73
									PE71S6408		\$805.70	74
				NO/T	PE71S6368	\$2,347.11	75					
					PE71S6369	\$2,438.65	76					
	NO/NT	PE71S6373		\$1,252.15	77							
		PE71S6409		\$1,024.73	78							
	NO/T	PE71S6380		\$2,855.50	79							
		PE71S6381		\$2,855.50	80							
	NO/TTL, NT	PE71S6374	\$1,379.76	81								
		PE71S6375	\$1,379.76	82								
	SP8T	SMA Female	L/I, RS, T	60	0.6	28	100	PE71S6080	\$6,745.06		83	
								L/S, AR, I, D, T	PE71S6081		\$6,565.37	84
NO/NT	PE71S6384		\$2,233.13	85								
	PE71S6076		\$4,035.49	86								
SP10T	PE71S6083		\$8,176.95	87								
	SP12T		PE71S6388	\$766.44	88							
Transfer			SMA Female	F/NT	60	0.5	12	60	PE71S6389	\$766.44	89	
	24								90	PE71S6400	\$661.14	90
										PE71S6410	\$2,950.95	91
20 GHz	SP10T		SMA Female	NO/NT	70	0.7	28	60	PE71S6356	\$1,218.73	92	
26.5 GHz	SPDT	SMA Female	F/T	50	0.6	12	50	PE71S6357	\$1,218.73	93		
								PE71S6370	\$2,753.07	94		
	SP4T		NO/T	70	0.7	28	40	PE71S6371	\$2,649.73	95		
								PE71S6079	\$4,395.95	96		
	SP6T		L/S, RS, D, T	50	70	12	50	PE71S6382	\$2,986.00	97		
								PE71S6383	\$2,986.00	98		
40 GHz	SPDT	2.92mm Female	L/I, TTL, S, T	50	0.8	28	10	PE71S6064	\$2,781.83	99		
								PE71S6089	\$3,054.81	1		
	SP6T		L/I, RS, T	45	1.1	5	PE71S6084	\$4,969.96	2			
							PE71S6078	\$2,977.38	3			
50 GHz	SPDT	2.4mm Female	F/NT	60	0.3	28	80	PE71S6329	\$1,438.18	4		
								PE71S6330	\$1,438.18	5		

2.5M Life Cycles



Features:
 A: Absorptive
 AR: Auto Reset
 F: Failsafe
 D: Diode
 GR: Global Reset
 H: Hot Switches
 I: Indicators
 L: Latching
 NO: Normally Open
 NT: Non-Terminated
 P: Pulse
 Latching
 R: Reflective
 RS: Reset
 S: Self Cut Off
 T: Terminated
 TTL: TTL Logic

Max Frequency (GHz)	Switch Type	Connector Type	Features	Min Isolation (dB)	Max IL (dB)	Voltage (V)	RF Power (W CW)	Model No	1 Pc. Price	See Web for Volume Pricing	ROW
12.4 GHz	Transfer	N Female	F/I, NT	60	0.5	28	200	PE71S6070	\$1,010.51	See Web for Volume Pricing	6
18 GHz	Transfer	SMA Female	F/NT	60	0.5	12	100	PE71S6066	\$878.70		7
								PE71S6065	\$878.70		8
								PE71S6069	\$1,343.93		9
			L/I, NT								

2.5M Life Cycles



Features:
 A: Absorptive
 AR: Auto Reset
 F: Failsafe
 D: Diode
 GR: Global Reset
 H: Hot Switches
 I: Indicators
 L: Latching
 NO: Normally Open
 NT: Non-Terminated
 P: Pulse
 R: Latching Reflective
 RS: Reset
 S: Self Cut Off
 T: Terminated
 TTL: TTL Logic

Max Frequency (GHz)	Switch Type	Connector Type	Features	Min Isolation (dB)	Max IL (dB)	Voltage (V)	RF Power (W CW)	Model No	1	2-4	5-9	10+	ROW
18 GHz	Transfer	SMA Female	L/I, S, NT	60	0.5	28	100	PE71S6067	\$1,085.64	\$1,042.21	\$998.79	\$955.36	10
			L/I, TTL, S, NT					PE71S6068	\$1,243.60	\$1,193.86	\$1,144.11	\$1,094.37	11
40 GHz	Transfer	2.92mm Female	L/I, S, NT	50	0.8	28	10	PE71S6071	\$1,834.86	\$1,761.47	\$1,688.07	\$1,614.68	12

5M Life Cycles



Features:
 A: Absorptive
 AR: Auto Reset
 F: Failsafe
 D: Diode
 GR: Global Reset
 H: Hot Switches
 I: Indicators
 L: Latching
 NO: Normally Open
 NT: Non-Terminated
 P: Pulse
 R: Latching Reflective
 RS: Reset
 S: Self Cut Off
 T: Terminated
 TTL: TTL Logic

Max Frequency (GHz)	Switch Type	Connector Type	Features	Min Isolation (dB)	Max IL (dB)	Voltage (V)	RF Power (W CW)	Model No	1 Pc. Price	See Web for Volume Pricing			ROW
12 GHz	SPDT	N Female	L/I, NT	70	0.5	28	200	PE71S6399	\$832.05	See Web for Volume Pricing			13
			L/NT					PE71S6349	\$754.60				14
	Transfer	SMA Female	L/NT	60	0.7	12	PE71S6387	\$1,029.64	15				
							PE71S6390	\$798.91	16				
18 GHz	SPDT	SMA Female	L/I, NT	65	0.35	12	60	PE71S6353	\$333.18	See Web for Volume Pricing			17
			L/I, T					PE71S6396	\$508.29				18
			L/I, TTL, T					PE71S6395	\$423.80				19
			L/NT					PE71S6406	\$1,071.29				20
			L/S, I, NT					PE71S6407	\$1,223.25				21
			L/T					PE71S6352	\$301.31				22
			L/T					PE71S6394	\$420.14				23
			L/T					PE71S6393	\$572.91				24
	DP3T	SMA Female	L/I, NT	80	0.4	12	28	PE71S6358	\$1,209.97				25
								PE71S6359	\$1,164.55				26
								PE71S6405	\$1,400.51				27
								PE71S6362	\$1,884.66				28
	SP3T	SMA Female	L/NT	80	0.4	12	28	PE71S6364	\$2,149.69				29
								PE71S6365	\$2,149.69				30
	SP4T	SMA Female	L/T	60	0.5	28	100	PE71S6074	\$1,686.91				31
								NO/NT	PE71S6077				\$2,864.74
L/NT								PE71S6372	\$2,392.63	33			
L/T								PE71S6376	\$2,966.86	34			
SP6T	SMA Female	L/T	80	0.4	12	60	PE71S6377	\$2,855.50	35				
							NO/NT	PE71S6075	\$2,010.17	36			
							L/I, NT	PE71S6402	\$724.79	37			
							L/S, I, NT	PE71S6401	\$897.52	38			
26.5 GHz	SPDT	SMA Female	L/T	50	0.6	12	50	PE71S6360	\$1,244.12	See Web for Volume Pricing			39
								PE71S6361	\$1,244.12				40
	SP4T							PE71S6366	\$2,596.73				41
								PE71S6367	\$2,753.07				42
								PE71S6378	\$2,986.00				43
SP6T	PE71S6379	\$2,986.00	44										
40 GHz	SP4T	2.92mm Female	L/I, S, RS, T 0.05	80	0.5	24	5	PE71S6334	\$6,819.82	See Web for Volume Pricing			45
			L/I, S, TTL, RS, T 0.05					PE71S6342	\$7,229.06				46
	L/I, S, RS, T 0.05		PE71S6332					\$7,274.49	47				
	L/I, S, TTL, RS, T 0.05		PE71S6340					\$7,510.99	48				

See Our Website For Current Pricing & Real-Time Stock Availability!

Switches

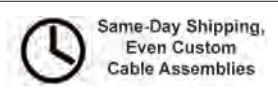

10M Life Cycles



Features:
 A: Absorptive
 AR: Auto Reset
 F: Failsafe
 D: Diode
 GR: Global Reset
 H: Hot Switches
 I: Indicators
 L: Latching
 NO: Normally Open
 NT: Non-Terminated
 P: Pulse
 Latching
 R: Reflective
 RS: Reset
 S: Self Cut Off
 T: Terminated
 TTL: TTL Logic

Max Frequency (GHz)	Switch Type	Connector Type	Features	Min Isolation (dB)	Max IL (dB)	Voltage (V)	RF Power (W CW)	Model No	1 Pc. Price	See Web for Volume Pricing			ROW
6 GHz	SP6T	SMA Female	L/GR, NT	70	0.3	28	70	PE71S6086	\$1,517.37	See Web for Volume Pricing			49
			NO/NT					PE71S6085	\$1,358.04				50
18 GHz	SPDT	SMA Female	F/NT	60	0.35	28	100	PE71S6052	\$315.41				51
			L/I, S, NT					PE71S6053	\$315.41				52
								PE71S6055	\$461.74				53
								PE71S6054	\$486.04				54
20 GHz	SPDT	SMA Female	L/I, S, NT 0.03	65	0.5	24	1	PE71S6335	\$1,430.68				55
			L/I, S, T 0.03					PE71S6337	\$2,074.85				56
			L/I, S, TTL, NT 0.03					PE71S6336	\$1,770.08				57
			L/I, S, TTL, T 0.03					PE71S6338	\$2,305.99				58
	SP4T		L/I, S, RS, T 0.03	80	0.6	70	PE71S6333	\$4,859.13	59				
			L/I, S, TTL, RS, T 0.03				PE71S6341	\$5,150.68	60				
			L/I, S, RS, T 0.03				PE71S6331	\$5,399.02	61				
			L/I, S, TTL, RS, T 0.03				PE71S6339	\$5,722.95	62				
26.5 GHz	SP6T	SMA Female	L/GR, NT	55	0.6	28	40	PE71S6087	\$2,319.45	63			
			NO/TTL, NT					PE71S6088	\$2,405.12	64			
40 GHz	SPDT	2.92mm Female	F/I, NT	50	0.8	28	10	PE71S6056	\$912.53	65			
			L/I, S, NT					PE71S6057	\$912.53	66			

Special Applications



Max Frequency (GHz)	Switch Type	Connector Type	Features	Min Isolation (dB)	Max IL (dB)	Voltage (V)	RF Power (W CW)	Model No	1 Pc. Price	See Web for Volume Pricing			ROW
1 GHz	A/B Coaxial	BNC Female		50	0.7	12	5	PE7100	\$569.49	See Web for Volume Pricing			67
	A/B Coaxial 75 Ohm	N Female						PE7102	\$436.68				68
								PE7103	\$389.21				69

SMT Packaged Electromechanical Switches



Features:
 A: Absorptive
 AR: Auto Reset
 F: Failsafe
 D: Diode
 GR: Global Reset
 H: Hot Switches
 I: Indicators
 L: Latching
 NO: Normally Open
 NT: Non-Terminated
 P: Pulse
 Latching
 R: Reflective
 RS: Reset
 S: Self Cut Off
 T: Terminated
 TTL: TTL Logic

Max Frequency (GHz)	Switch Type	Connector Type	Features	Min Isolation (dB)	Max IL (dB)	Voltage (V)	RF Power (W CW)	Model No	1-9	10-24	25-49	50+	ROW
3 GHz	SPDT	SMT	F/H, Non-T	40	0.3	12	175	PE71S6345	\$239.04	\$227.09	\$215.14	\$205.57	70
			L/H, Non-T					PE71S6346*	\$239.04	\$227.09	\$215.14	\$205.57	71
8 GHz			F/H, Non-T	30	0.8	24	35	PE71S6092	\$291.45	\$276.88	\$262.31	\$250.65	72
			L/H, Non-T					PE71S6093	\$280.51	\$266.48	\$252.46	\$241.24	73

*Available SMA Connectorized Application PWB Option. Model PE71S8001 PWB supports connectorized SPDT. Model PE71S8002 PWB supports Connectorized SP4T.

Waveguide Electromechanical Relay Switches, See Page 340

Manual Switches



Impedance	Connector	Gender	Number of Output Ports	Frequency Range (MHz.)	Maximum Power	Model No	1 Pc. Price	See Web for Volume Pricing		R O W
50 Ohm	N	Female to		DC - 1,300	500 Watt	PE7139	\$241.54	See Web for Volume Pricing		74
	SMA			DC - 22,000	50 Watt	PE7140	\$384.06			75
						PE7SM1000A	\$830.16			76

PIN Diode Switches

SPST



Switch Design	Freq. (GHz.)	Typ Iso (dB)	Typ IL (dB)	Switch Time (ns)	Max Input Power (dB)	TTL Control	Conn. Type	Model No	1	2-4	5-9	10+	R O W	
Absorptive	10 MHz - 1	80	1.3	200	0.1	Solder Pin	SMA Female	PE71S6230	\$1,678.09	\$1,610.97	\$1,543.84	\$1,476.72	77	
	50 MHz - 26.5	30	5	150	0.5		SMA Female	PE71S2008	\$5,556.99	\$5,334.71	\$5,112.43	\$4,890.15	78	
	50 MHz - 40	25	7.5		1		2.92mm Female	PE71S2012	\$5,905.02	\$5,668.82	\$5,432.62	\$5,196.42	79	
	50 MHz - 67		9.5	0.5	1.85mm Female		PE71S2024	\$7,468.02	\$7,169.30	\$6,870.58	\$6,571.86	80		
	500 MHz - 18	55	3.5	100	0.1		SMA Female	PE71S6209	\$2,746.31	\$2,636.46	\$2,526.61	\$2,416.75	81	
	500 MHz - 40		5.5				2.92mm Female	PE71S6214	\$3,980.86	\$3,821.63	\$3,662.39	\$3,503.16	82	
	1 - 2	80	0.9	50	0.1		SMA Female	PE71S6231	\$1,880.20	\$1,804.99	\$1,729.78	\$1,654.58	83	
	1 - 18	65	3					PE71S6236	\$2,601.94	\$2,497.86	\$2,393.78	\$2,289.71	84	
	2 - 4	75	1.1	150	1		SMA Female	PE71S6232	\$1,962.43	\$1,883.93	\$1,805.44	\$1,726.94	85	
	2 - 26.5	25	4.5					PE71S2016	\$5,323.34	\$5,110.41	\$4,897.47	\$4,684.54	86	
	2 - 40	30	5	50	0.1		SMA Female	2.92mm Female	PE71S2020	\$5,384.02	\$5,168.66	\$4,953.30	\$4,737.94	87
	4 - 8	75	1.8					PE71S6233	\$2,241.06	\$2,151.42	\$2,061.78	\$1,972.13	88	
	8 - 12	70	2.8	150	0.1		SMA Female	PE71S6234	\$2,327.67	\$2,234.56	\$2,141.46	\$2,048.35	89	
	12 - 18	65						PE71S6235	\$2,399.86	\$2,303.87	\$2,207.87	\$2,111.88	90	
	Reflective	10 MHz - 1	80	1	200		0.1	Solder Pin	SMA Female	PE71S6258	\$1,605.91	\$1,541.67	\$1,477.44	\$1,413.20
50 MHz - 26.5		20	5	150	1	SMA Female	PE71S2007		\$4,793.20	\$4,601.47	\$4,409.74	\$4,218.02	92	
50 MHz - 40		25	6.5		0.5	2.92mm Female	PE71S2011		\$5,140.19	\$4,934.58	\$4,728.97	\$4,523.37	93	
50 MHz - 67		20	8.5	0.1	1.85mm Female	PE71S2023	\$6,339.53		\$6,085.95	\$5,832.37	\$5,578.79	94		
500 MHz - 18		55	3	100	0.1	SMA Female	PE71S6220		\$2,573.74	\$2,470.79	\$2,367.84	\$2,264.89	95	
500 MHz - 40			5			2.92mm Female	PE71S6225		\$3,004.43	\$2,884.25	\$2,764.08	\$2,643.90	96	
1 - 2		80	0.75	50	0.1	SMA Female	PE71S6259		\$1,740.14	\$1,670.53	\$1,600.93	\$1,531.32	97	
1 - 18		65	2.5				PE71S6264		\$2,529.78	\$2,428.59	\$2,327.40	\$2,226.21	98	
2 - 4		75	0.85	150	1	SMA Female	PE71S6260		\$1,892.98	\$1,817.26	\$1,741.54	\$1,665.82	99	
2 - 26.5		20	4.5				PE71S2015		\$4,511.36	\$4,330.91	\$4,150.45	\$3,970.00	1	
2 - 40			4	0.1	2.92mm Female	PE71S2019	\$4,689.00		\$4,501.44	\$4,313.88	\$4,126.32	2		
4 - 8		75	1.5	50	0.1	SMA Female	PE71S6261		\$2,087.47	\$2,003.97	\$1,920.47	\$1,836.97	3	
8 - 12		70	1.8				PE71S6262		\$2,170.83	\$2,084.00	\$1,997.16	\$1,910.33	4	
12 - 18		65	2.5				PE71S6263		\$2,240.30	\$2,150.69	\$2,061.08	\$1,971.46	5	

SPDT



Switch Design	Freq. (GHz.)	Typ Iso (dB)	Typ IL (dB)	Switch Time (ns)	Max Input Power (dB)	TTL Control	Conn. Type	Model No	1	2-4	5-9	10+	R O W
Absorptive	5 MHz - 2.15	70	2.5	100,000	0.1	D-Sub	F Female	PE71S2043	\$1,332.23	\$1,278.94	\$1,225.65	\$1,172.36	6

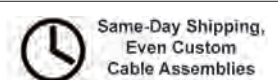

SPDT



See Our Website For Current Pricing & Real-Time Stock Availability!

Switch Design	Freq. (GHz.)	Typ Iso (dB)	Typ IL (dB)	Switch Time (ns)	Max Input Power (dB)	TTL Control	Conn. Type	Model No	1 Pc. Price	See Web for Volume Pricing			ROW	
Absorptive	5 MHz - 3	80	3.5	10,000	1	D-Sub	SMA Female	PE71S2036	\$1,137.48	See Web for Volume Pricing			7	
	10 MHz - 1		1.3	200	0.1	Solder Pin		PE71S6237	\$1,952.35				8	
	20 MHz - 4.3		3	10,000	1	D-Sub		PE71S2035	\$1,137.48				9	
	70 MHz - 26.5	55	5	100	0.5	SMA Female	PE71S2010	\$8,682.99	10					
	70 MHz - 40		7			2.92mm Female	PE71S2014	\$8,943.49	11					
	100 MHz - 67	40	10.5			SMA Female	PE71S2026	Call	12					
	500 MHz - 18	55	3.75			SMA Female	PE71S6210	\$3,121.60	13					
	500 MHz - 40	60	6	50	100	Solder Pin	2.92mm Female	PE71S6215	\$5,145.65				14	
	800 MHz - 2.7	75	0.8	10,000		100	PE71S2041	\$3,310.10	15					
	1 - 18	65	3.5	100	0.1	Solder Pin	SMA Female	PE71S6241	\$2,868.99				16	
	2 - 4	75	1.2					Pin	PE71S6208				\$2,237.47	17
	2 - 26.5	60	4					SMA Female	PE71S2018				\$7,999.44	18
	2 - 40	55	5.5			2.92mm Female	PE71S2022	\$8,336.00	19					
	4 - 8	70	1.9			0.1	Solder Pin	SMA Female	PE71S6238				\$2,508.13	20
	8 - 12		2.2						PE71S6239				\$2,601.94	21
	12 - 18		3.5	PE71S6240	\$2,674.12				22					
10 MHz - 1	80	1.1	200	0.1	Solder Pin	SMA Female	PE71S6265	\$1,809.62	23					
20 MHz - 500 MHz	50	0.5	40,000	150			PE71S2039	\$3,176.39	24					
20 MHz - 1	40	0.75	10,000	25			PE71S2040	\$3,176.39	25					
20 MHz - 2.5	50	1					PE71S2042	\$2,896.21	26					
30 MHz - 530 MHz	60	1	200	5			PE71S2047	\$711.44	27					
50 MHz - 1.5	4		PE71S2048	\$711.44			28							
70 MHz - 26.5	30	3.5	100	0.5			SMA Female	PE71S2009	\$6,773.00	29				
70 MHz - 40		5.5					2.92mm Female	PE71S2013	\$7,119.99	30				
100 MHz - 500 MHz	55	0.5	40,000	250			Solder Pin	SMA Female	PE71S2038	\$3,057.16	31			
500 MHz - 18		3.2	100	PE71S6221					\$2,934.98	32				
500 MHz - 40		5.5	50	0.1	2.92mm Female	PE71S6226			\$3,247.58	33				
1 - 18	65	2.5	100	0.1	Solder Pin	SMA Female	PE71S6269	\$2,796.81	34					
2 - 4	75	0.9					PE71S6219	\$2,084.00	35					
2 - 26.5	30	3					PE71S2017	\$7,480.79	36					
2 - 40	4	0.5			2.92mm Female	PE71S2021	\$7,822.50	37						
4 - 8	70	1.6			0.1	Solder Pin	SMA Female	PE71S6266	\$2,344.50	38				
8 - 12		1.9						PE71S6267	\$2,529.78	39				
12 - 18		2.5	PE71S6268	\$2,504.27				40						

SP3T



Switch Design	Freq. (GHz.)	Typ Iso (dB)	Typ IL (dB)	Switch Time (ns)	Max Input Power (dB)	TTL Control	Conn. Type	Model No	1	2-4	5-9	10+	ROW	
Absorptive	10 MHz - 1	60	1.4	200	0.1	Solder Pin	SMA Female	PE71S6242	\$2,136.10	\$2,050.66	\$1,965.21	\$1,879.77	41	
	500 MHz - 18	55	3.8	100				PE71S6211	\$3,482.85	\$3,343.54	\$3,204.22	\$3,064.91	42	
	500 MHz - 40	60	6	50				2.92mm Female	PE71S6216	\$5,527.60	\$5,306.50	\$5,085.39	\$4,864.29	43
	1 - 2		1.25	100				SMA Female	PE71S6243	\$2,330.62	\$2,237.40	\$2,144.17	\$2,050.95	44

Switches

SP3T



Switch Design	Freq. (GHz.)	Typ Iso (dB)	Typ IL (dB)	Switch Time (ns)	Max Input Power (dB)	TTL Control	Conn. Type	Model No	1 Pc. Price	See Web for Volume Pricing	ROW
Absorptive	1 - 18	65	3.75	100	0.1	Solder Pin	SMA Female	PE71S6248	\$3,004.43	See Web for Volume Pricing	45
	2 - 4	75	1.5					PE71S6244	\$2,483.43		46
	4 - 8		2.5					PE71S6245	\$2,782.38		47
	8 - 12	70	2.8					PE71S6246	\$2,868.99		48
	12 - 18		3.75					PE71S6247	\$2,830.78		49
Reflective	10 MHz - 1	60	1	200	0.1	Solder Pin	SMA Female	PE71S6270	\$2,147.23	See Web for Volume Pricing	50
	500 MHz - 18	55	3.2					PE71S6222	\$3,282.30		51
	500 MHz - 40		5.5					PE71S6227	\$5,142.53		52
	1 - 2	60	1	100	0.5	Solder Pin	SMA Female	PE71S6271	\$2,261.14		53
	1 - 18	65	3.3					PE7120D	Call		54
			2.75					PE71S6276	\$2,935.32		55
	2 - 4	75	1.2	100	0.1	Solder Pin	SMA Female	PE71S6272	\$2,413.98		56
	4 - 8		2					PE71S6273	\$2,608.47		57
	8 - 12	70	2.4	100	0.1	Solder Pin	SMA Female	PE71S6274	\$2,796.81		58
	12 - 18		2.75					PE71S6275	\$2,761.30		59

SP4T



Switch Design	Freq. (GHz.)	Typ Iso (dB)	Typ IL (dB)	Switch Time (ns)	Max Input Power (dB)	TTL Control	Conn. Type	Model No	1 Pc. Price	See Web for Volume Pricing	ROW
Absorptive	5 MHz - 2.15	70	2.5	100,000	0.1	D-Sub	F Female	PE71S2044	\$1,823.06	See Web for Volume Pricing	60
	5 MHz - 3		3.5	10,000	1		SMA Female	PE71S2037	\$1,560.01		61
	10 MHz - 1	60	1.5	200	0.1	Solder Pin	SMA Female	PE71S6249	\$2,400.07		62
	500 MHz - 18	55	3.8	100				PE71S6212	\$4,853.82		63
	500 MHz - 40	60	8	50			2.92mm Female	PE71S6217	\$7,199.54		64
	1 - 2		1.2	100			SMA Female	PE71S6250	\$2,587.63		65
	1 - 18	70	3.75					PE71S6255	\$3,268.42		66
	2 - 4	75	1.5	50			PE71S6251	\$2,747.42	67		
	2 - 6	70	2.5	100			PE71S6256	Call	68		
	4 - 8		2.2	50			PE71S6252	\$2,934.98	69		
	6 - 12	3	50	PE71S6257			Call	70			
	8 - 12	70	2.6	100			PE71S6253	\$3,143.26	71		
12 - 18	3.75		100	PE71S6254			\$3,094.74	72			
Reflective	10 MHz - 1	60	1.2	200			0.1	Solder Pin	SMA Female	PE71S6277	\$2,330.96
	500 MHz - 18	55	3.2	100	PE71S6223	\$4,602.18				74	
	500 MHz - 40		7.5	50	2.92mm Female	PE71S6228			\$6,865.04	75	
	1 - 2	60	1	100	SMA Female	PE71S6278			\$2,518.52	76	
	1 - 18	70	3			PE71S6283			\$3,198.94	77	
	2 - 4	75	1.1	50	PE71S6279	\$2,677.94			78		
	2 - 6	70	2	100	PE71S6284	\$2,587.63			79		
	4 - 8		1.8	50	PE71S6280	\$2,865.50			80		
	6 - 12	2.5	100	PE71S6285	\$2,657.10	81					
	8 - 12	70	2.2	50	PE71S6281	\$2,955.82			82		
	12 - 18		3	100	PE71S6282	\$3,025.27			83		

See Our Website For Current Pricing & Real-Time Stock Availability!

Switches

SP5T



Switch Design	Freq. (GHz.)	Typ Iso (dB)	Typ IL (dB)	Switch Time (ns)	Max Input Power (dB)	TTL Control	Conn. Type	Model No	1	2-4	5-9	10+	R O W
Absorptive	100 MHz - 20	65	3.9	75	0.5	Solder Pin	SMA Female	PE71S2045	\$4,289.58	\$4,118.00	\$3,946.41	\$3,774.83	84

SP6T



Switch Design	Freq. (GHz.)	Typ Iso (dB)	Typ IL (dB)	Switch Time (ns)	Max Input Power (dB)	TTL Control	Conn. Type	Model No	1 Pc. Price	See Web for Volume Pricing			R O W
Absorptive	100 MHz - 20	65	4.2	75	0.5	Solder Pin	SMA Female	PE71S2032	Call				85
								PE71S2046	\$4,761.94				86

SP8T



Switch Design	Freq. (GHz.)	Typ Iso (dB)	Typ IL (dB)	Switch Time (ns)	Max Input Power (dB)	TTL Control	Conn. Type	Model No	1	2-4	5-9	10+	R O W
Absorptive	100 MHz - 20	65	6	100	0.5	Solder Pin	SMA Female	PE71S2033	\$7,957.39	\$7,639.09	\$7,320.80	\$7,002.50	87
	500 MHz - 18	55	4.5	50	0.1		2.92mm Female	PE71S6213	\$7,740.86	\$7,431.23	\$7,121.59	\$6,811.96	88
	500 MHz - 40	50	10				2.92mm Female	PE71S6218	\$9,725.69	\$9,336.66	\$8,947.63	\$8,558.61	89
Reflective	500 MHz - 18	55	4	100	0.1	Solder Pin	SMA Female	PE71S6224	\$7,668.68	\$7,361.93	\$7,055.19	\$6,748.44	90
	500 MHz - 40	45	9	50			2.92mm Female	PE71S6229	\$9,653.54	\$9,267.40	\$8,881.26	\$8,495.12	91

SP12T



Switch Design	Freq. (GHz.)	Typ Iso (dB)	Typ IL (dB)	Switch Time (ns)	Max Input Power (dB)	TTL Control	Conn. Type	Model No	1	2-4	5-9	10+	R O W
Absorptive	100 MHz - 20	65	6	100	0.5	Solder Pin	SMA Female	PE71S2034	\$10,458.28	\$10,039.95	\$9,621.62	\$9,203.29	92

Transfer



Switch Design	Freq. (GHz.)	Typ Iso (dB)	Typ IL (dB)	Switch Time (ns)	Max Input Power (dB)	TTL Control	Conn. Type	Model No	1	2-4	5-9	10+	R O W
Absorptive	10 MHz - 1	80	1.3	100	2	Solder Pin	SMA Female	PE71S6286	\$2,962.83	\$2,844.32	\$2,725.80	\$2,607.29	93
	1 - 2		1		1			PE71S6287	\$3,121.60	\$2,996.74	\$2,871.87	\$2,747.01	94
	1 - 18	65	3.1		0.5			PE71S6292	\$5,380.71	\$5,165.48	\$4,950.25	\$4,735.02	95
	2 - 4	75	1.2		1			PE71S6288	\$3,323.70	\$3,190.75	\$3,057.80	\$2,924.86	96
	4 - 8		1.9		PE71S6289			\$3,351.78	\$3,217.71	\$3,083.64	\$2,949.57	97	
	8 - 12	70	2.2		0.5			PE71S6290	\$3,546.27	\$3,404.42	\$3,262.57	\$3,120.72	98
	12 - 18	65	3					PE71S6291	\$4,046.43	\$3,884.57	\$3,722.72	\$3,560.86	99

High Isolation PIN Diode Switches



Switch Design	Freq. (GHz.)	Typ Iso (dB)	Typ IL (dB)	Switch Time (ns)	TTL Control	Conn. Type	Model No	1	2-4	5-9	10+	ROW
SPST	0 - 20	65	6	8.5	Solder Pin	SMA Female	PE71S5001	\$6,338.99	\$6,085.43	\$5,831.87	\$5,578.31	1
SPDT	0 - 18		3	12			PE71S5005	\$6,297.94	\$6,046.02	\$5,794.10	\$5,542.19	2
	0 - 20	35	4	5	PE71S5000		\$4,226.00	\$4,056.96	\$3,887.92	\$3,718.88	3	
	1 - 2	90	1	75	Solder Terminals		PE71S5002	\$1,862.89	\$1,788.37	\$1,713.86	\$1,639.34	4
SP4T	0 - 20	38	3.8		Solder Pin		PE71S5006	\$7,249.51	\$6,959.53	\$6,669.55	\$6,379.57	5
	2 - 6	80	1.8	35	Solder Terminals		PE71S5003	\$2,435.94	\$2,338.50	\$2,241.06	\$2,143.63	6
	6 - 12	75	2.5	40			PE71S5004	\$2,623.58	\$2,518.64	\$2,413.69	\$2,308.75	7

High Isolation USB PIN Diode Switches



Switch Type	Frequency Band (GHz.)	Insertion Loss (dB)	Isolation (dB)	Switching Speed (µs)	Model No	1	2-4	5-9	10+	ROW
USB	0.5 - 18.0	6	60	6,000	PE71S3900	\$3,391.37	\$3,255.72	\$3,120.06	\$2,984.41	8
	0.5 - 40.0				PE71S3901	\$4,626.00	\$4,440.96	\$4,255.92	\$4,070.88	9

GaN High Power Switches



Switch Design	Freq. (GHz.)	Typ Iso (dB)	Typ IL (dB)	Switch Time (ns)	Max Input Power (dB)	TTL Control	Conn. Type	Model No	1	2-4	5-9	10+	ROW
Reflective	DC - 6	33	0.9	100	46	Solder Pin	SMA	PE71S1100	Call	Call	Call	Call	10
	DC - 12	32	1.5		44		SMA	PE71S1101	Call	Call	Call	Call	11
	DC - 18	30	1.3	50	40		N Type	PE71S1102	Call	Call	Call	Call	12
	0.5 - 6	43	1.2	100	50		N Type	PE71S1103	Call	Call	Call	Call	13
	DC - 6	36	1.3		46		SMA	PE71S1104	Call	Call	Call	Call	14
		33	0.9	44	SMA		PE71S1105	Call	Call	Call	Call	15	
	DC - 12	32	1.5	50	40		SMA	PE71S1106	Call	Call	Call	Call	16
	DC - 18	30	1.3	50	40		SMA	PE71S1107	Call	Call	Call	Call	17
	0.5 - 6	43	1.2	100	50		N Type	PE71S1108	Call	Call	Call	Call	18
DC - 6	36	1.3	46	SMA	PE71S1109	Call	Call	Call	Call	19			

INDEX GUIDE TO SYNTHESIZERS AND OSCILLATORS

SYNTHESIZERS.....	300
VOLTAGE CONTROLLED OSCILLATORS.....	301
<i>0.175" Ultra Small Commercial Surface Mount Packaged VCO.....</i>	<i>301</i>
<i>0.5" Commercial Surface Mount Packaged VCO.....</i>	<i>301</i>
<i>0.5" Commercial Surface Mount Packaged VCO w/ Integrated Buffer Amps.....</i>	<i>302</i>
<i>0.5" Commercial Surface Mount Packaged VCO w/ Low Noise.....</i>	<i>302</i>
<i>0.5" Commercial Surface Mount Packaged VCO w/ Modulation Input Port.....</i>	<i>302</i>
<i>0.5" Hermetically Sealed MIL Grade Surface Mount Packaged VCO.....</i>	<i>302</i>
<i>Connectorized Packaged VCO w/ Field Replaceable Connectors.....</i>	<i>303</i>
<i>Hi Rel Hermetic Buffer Amp.....</i>	<i>303</i>
<i>Commercial Standard.....</i>	<i>303</i>
<i>Phase Locked Oscillators.....</i>	<i>304</i>
<i>Phase Locked Crystal Oscillators.....</i>	<i>304</i>
<i>Reference Oscillators.....</i>	<i>303</i>
TCXO Oscillators.....	304

SYNTHESIZERS



Synthesizers & Oscillators

Type	Freq. Band (MHz.)	Typ Ref. Freq. (MHz.)	Ph. Noise @100kHz Offset (dBc/Hz)	Output Power (dBm)	2nd Harmonic	Output Connector	Model No	1	2-4	5-9	10+	R O W
Serial, TTL	2,000 - 6,000	10	-94	14 to 17	-22	SMA Female	PE11S1002	\$9,851.61	\$9,457.55	\$9,063.48	\$8,669.42	1
	5,500 - 10,500		-90	19 to 21	-20		PE11S1001	\$10,235.82	\$9,826.39	\$9,416.95	\$9,007.52	2
USB	25 - 6,000	50	-86	-40 to 20	-25		PE11S3901	\$6,237.48	\$5,987.98	\$5,738.48	\$5,488.98	3
	35 - 4,400		-103	-20 to 10	-30		PE11S3900	\$1,809.55	\$1,737.17	\$1,664.79	\$1,592.40	4
	5,000 - 10,000		-72	-15 to 18	-25		PE11S3902	\$7,374.55	\$7,079.57	\$6,784.59	\$6,489.60	5
	10,000 - 20,000		-80	-19 to 18	-15		PE11S3903	\$7,847.90	\$7,573.22	\$7,298.55	\$7,063.11	6
	21,000 - 24,000		-88	-17 to 17	-22		PE11S3904	\$5,936.43	\$5,698.97	\$5,461.52	\$5,224.06	7
	24,000 - 27,000		-75	14 to 17			PE11S3905	\$6,292.62	\$6,040.92	\$5,789.21	\$5,537.51	8

OSCILLATORS

0.175" Ultra Small Commercial Surface Mount Packaged VCO



Frequency (MHz.)	Tuning Voltage (Vdc)	Output Power Typ (dBm)	Supply Voltage (Vdc)	Phase Noise* (dBc/Hz)	2nd Harmonics Typ (dBc)	Pushing Typ (MHz.)	Pulling Typ (MHz.)	Model No	1-24	25-49	50-99	100+	R O W
125 - 250	DC - 18	8	5	-107	-10	0.5	3	PE2V000	\$99.34	\$94.37	\$89.41	\$85.43	9
200 - 400	DC - 5	6	3	-95	-14	4	7	PE2V001	\$103.21	\$98.05	\$92.89	\$88.76	10
250 - 500	DC - 20	8	5	-107	-8	1	3	PE2V002	\$99.34	\$94.37	\$89.41	\$85.43	11
500 - 1,000	DC - 19	6	10	-97	-10	4	10	PE2V003	\$103.21	\$98.05	\$92.89	\$88.76	12
800 - 1,600	DC - 18	11	5	-93	-17	4	20	PE2V004	\$99.34	\$94.37	\$89.41	\$85.43	13
1,000 - 2,000	DC - 20	10	12	-90	-7	2	20	PE2V005	\$99.34	\$94.37	\$89.41	\$85.43	14
2,000 - 2,750	DC - 10	11	11	-86	-17	6	22	PE2V006	\$99.34	\$94.37	\$89.41	\$85.43	15
2,000 - 3,000	DC - 20	9	12	-87	-14	2	24	PE2V007	\$103.21	\$98.05	\$92.89	\$88.76	16
3,120 - 3,920	DC - 11	8	10	-87	-22	10	22	PE2V008	\$99.34	\$94.37	\$89.41	\$85.43	17
3,570 - 4,580	DC - 11.5	8	12	-83	-17	4	15	PE2V009	\$103.21	\$98.05	\$92.89	\$88.76	18
4,400 - 5,000	DC - 4.5	1	5	-85	-17	5	18	PE2V010	\$99.34	\$94.37	\$89.41	\$85.43	19
4,800 - 5,200	DC - 3	1	3.3	-80	-20	4	25	PE2V011	\$99.34	\$94.37	\$89.41	\$85.43	20
4,800 - 5,700	DC - 11	8	12	-84	-20	2	20	PE2V012	\$103.21	\$98.05	\$92.89	\$88.76	21
5,180 - 5,805	DC - 10	6	11	-83	-20	5	25	PE2V013	\$103.21	\$98.05	\$92.89	\$88.76	22
5,400 - 5,900	DC - 10	8.5	11	-84	-25	5	25	PE2V014	\$103.21	\$98.05	\$92.89	\$88.76	23
6,100 - 7,000	DC - 10	5.5	5	-76	-30	5	15	PE2V015	\$103.21	\$98.05	\$92.89	\$88.76	24
7,390 - 8,060	DC - 9	4	5	-75	-22	10	40	PE2V016	\$103.21	\$98.05	\$92.89	\$88.76	25
8,300 - 9,100	DC - 10	1	5	-73	-25	5	20	PE2V017	\$103.21	\$98.05	\$92.89	\$88.76	26
9,000 - 10,000	DC - 11	7	12	-78	-30	15	50	PE2V018	\$103.21	\$98.05	\$92.89	\$88.76	27
10,000 - 11,000	DC - 11	4	12	-72	-40	15	70	PE2V019	\$103.21	\$98.05	\$92.89	\$88.76	28

0.5" Commercial Surface Mount Packaged VCO



Frequency (MHz.)	Tuning Voltage (Vdc)	Output Power Typ (dBm)	Supply Voltage (Vdc)	Phase Noise* (dBc/Hz)	2nd Harmonics Typ (dBc)	Pushing Typ (MHz.)	Pulling Typ (MHz.)	Model No	1-24	25-49	50-99	100+	R O W
10 - 20	DC - 20	10	15	-120	-11	0.02	0.05	PE1V11000	\$99.17	\$94.21	\$89.25	\$85.29	29
18 - 30	DC - 12	12	12	-120	-13	0.03	0.07	PE1V11001	\$99.17	\$94.21	\$89.25	\$85.29	30
25 - 50	DC - 15	11.5	15	-120	-12	0.05	0.03	PE1V11002	\$95.45	\$90.68	\$85.91	\$82.09	31
30 - 60	DC - 15	11	15	-119	-14	0.05	0.05	PE1V11003	\$95.45	\$90.68	\$85.91	\$82.09	32
40 - 80	DC - 20	12	15	-117	-14	0.05	0.05	PE1V11004	\$99.17	\$94.21	\$89.25	\$85.29	33
40 - 100	DC - 20	11.5	15	-118	-14	0.2	0.1	PE1V11005	\$95.45	\$90.68	\$85.91	\$82.09	34
50 - 100	DC - 20	12	15	-115	-12	0.05	0.1	PE1V11006	\$95.45	\$90.68	\$85.91	\$82.09	35
60 - 120	DC - 18.5	11	15	-114	-20	0.2	0.1	PE1V11007	\$95.45	\$90.68	\$85.91	\$82.09	36
75 - 150	DC - 18	11	15	-110	-20	0.2	0.4	PE1V11008	\$95.45	\$90.68	\$85.91	\$82.09	37
100 - 200	DC - 18	11	15	-113	-12	0.2	0.1	PE1V11009	\$95.45	\$90.68	\$85.91	\$82.09	38
150 - 300	DC - 20	11	15	-108	-14	1	2	PE1V11010	\$99.17	\$94.21	\$89.25	\$85.29	39
200 - 400	DC - 20	11	15	-106	-14	0.4	0.2	PE1V11011	\$99.17	\$94.21	\$89.25	\$85.29	40
300 - 400	DC - 9	11	15	-102	-18	0.6	0.5	PE1V11012	\$99.17	\$94.21	\$89.25	\$85.29	41
400 - 600	DC - 15	11	15	-102	-15	1	1.5	PE1V11013	\$95.45	\$90.68	\$85.91	\$82.09	42
400 - 800	DC - 9	8	5	-96	-14	3	1.3	PE1V11014	\$95.45	\$90.68	\$85.91	\$82.09	43
500 - 900	DC - 11.5	12	12	-95	-14	1.5	1.5	PE1V11015	\$95.45	\$90.68	\$85.91	\$82.09	44
600 - 1,000	DC - 20	12.5	15	-96	-15	0.8	0.7	PE1V11016	\$99.17	\$94.21	\$89.25	\$85.29	45
800 - 1,200	DC - 20	11.5	15	-95	-12	0.8	2.5	PE1V11017	\$99.17	\$94.21	\$89.25	\$85.29	46
1,200 - 1,800	DC - 20	11	15	-89	-12	0.5	3	PE1V11018	\$99.17	\$94.21	\$89.25	\$85.29	47
1,350 - 1,650	DC - 18	10	15	-	-12	1.5		PE1V11019	\$95.45	\$90.68	\$85.91	\$82.09	48
1,500 - 2,100	DC - 18	10	15	-	-12			PE1V11020	\$95.45	\$90.68	\$85.91	\$82.09	49
1,500 - 2,500	DC - 16	10	15	-	-12			PE1V11021	\$99.17	\$94.21	\$89.25	\$85.29	50
2,000 - 2,750	DC - 10	7	11	-	-12			PE1V11022	\$99.17	\$94.21	\$89.25	\$85.29	51
2,570 - 3,300	DC - 10	5	11	-	-15			PE1V11023	\$99.17	\$94.21	\$89.25	\$85.29	52
3,000 - 3,500	DC - 10	10	11	-81	-16	2.5	12	PE1V11024	\$95.45	\$90.68	\$85.91	\$82.09	53
3,120 - 3,870	DC - 10	5	11	-	-15			PE1V11025	\$99.17	\$94.21	\$89.25	\$85.29	54
4,000 - 5,000	DC - 15	8	15	-	-18			PE1V11026	\$99.17	\$94.21	\$89.25	\$85.29	55
4,260 - 5,000	DC - 10	7	11	-	-18			PE1V11027	\$95.45	\$90.68	\$85.91	\$82.09	56

* Phase Noise measured at 10 KHz offset frequency

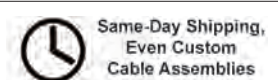

See Our Website For Current Pricing & Real-Time Stock Availability!

Synthesizers & Oscillators

0.5" Commercial Surface Mount Packaged VCO w/ Integrated Buffer Amps



Frequency (MHz.)	Tuning Voltage (Vdc)	Output Power Typ (dBm)	Supply Voltage (Vdc)	Phase Noise* (dBc/Hz)	2nd Harmonics Typ (dBc)	Pushing Typ (MHz.)	Pulling Typ (MHz.)	Model No	1-24	25-49	50-99	100+	R O W
510 - 550	DC - 3.5	6.5	5	-106	-22	1.5	0.8	PE1V14000	\$95.45	\$90.68	\$85.91	\$82.09	57
950 - 1,100	DC - 4.5	9	5	-104	-18	0.8	0.3	PE1V14001	\$95.45	\$90.68	\$85.91	\$82.09	58
1,570 - 1,850	DC - 4.5	5	5	-101	-18	1.8	0.2	PE1V14002	\$99.17	\$94.21	\$89.25	\$85.29	59
1,600 - 3,200	DC - 20	6	5	-89	-14	4	10	PE1V14003	\$99.17	\$94.21	\$89.25	\$85.29	60
1,700 - 1,850	DC - 4.5	3.5	5	-100	-40	0.8	0.2	PE1V14004	\$95.45	\$90.68	\$85.91	\$82.09	61
1,800 - 2,000	DC - 4.5	4.5	5	-100	-20	1.5	0.6	PE1V14005	\$95.45	\$90.68	\$85.91	\$82.09	62
1,900 - 2,100	DC - 4.5	4.5	5	-102	-40	3	0.3	PE1V14006	\$95.45	\$90.68	\$85.91	\$82.09	63
2,100 - 2,300	DC - 4.5	4.5	5	-101	-35	2.5	0.3	PE1V14007	\$99.17	\$94.21	\$89.25	\$85.29	64
2,800 - 3,000	DC - 4.5	-2	5	-93	-25	2	0.8	PE1V14008	\$95.45	\$90.68	\$85.91	\$82.09	65
4,130 - 4,350	DC - 8	7.5	8	-98	-30	4	6	PE1V14009	\$95.45	\$90.68	\$85.91	\$82.09	66
4,770 - 5,010	DC - 7.5	5	8	-98	-20	4	4	PE1V14010	\$95.45	\$90.68	\$85.91	\$82.09	67

0.5" Commercial Surface Mount Packaged VCO w/ Low Noise



Frequency (MHz.)	Tuning Voltage (Vdc)	Output Power Typ (dBm)	Supply Voltage (Vdc)	Phase Noise* (dBc/Hz)	2nd Harmonics Typ (dBc)	Pushing Typ (MHz.)	Pulling Typ (MHz.)	Model No	1-24	25-49	50-99	100+	R O W
305 - 425	DC - 19.5	8	5	-117	-40	1.5	4	PE1V15000	\$95.45	\$90.68	\$85.91	\$82.09	68
850 - 900	DC - 4.5	1.5	5	-113	-45	0.3	0.2	PE1V15001	\$99.17	\$94.21	\$89.25	\$85.29	69

0.5" Commercial Surface Mount Packaged VCO w/ Modulation Input Port



Frequency (MHz.)	Tuning Voltage (Vdc)	Output Power Typ (dBm)	Supply Voltage (Vdc)	Phase Noise* (dBc/Hz)	2nd Harmonics Typ (dBc)	Pushing Typ (MHz.)	Pulling Typ (MHz.)	Model No	1-9	10-24	25-49	50+	R O W
130 - 175	DC - 15	6.5	5	-125	-25	0.1	0.2	PE1V12000	\$114.55	\$108.82	\$103.10	\$98.51	70
195 - 240	DC - 15	8.5	5	-125	-15	0.2	0.05	PE1V12001	\$114.55	\$108.82	\$103.10	\$98.51	71
243 - 270	DC - 9.5	10	8	-120	-38	0.05	0.2	PE1V12002	\$119.02	\$113.07	\$107.12	\$102.36	72
260 - 280	DC - 10	8	5	-123	-15	0.1	0.1	PE1V12003	\$114.55	\$108.82	\$103.10	\$98.51	73
380 - 400	DC - 10	4.5	5	-124	-20	0.2	0.1	PE1V12004	\$114.55	\$108.82	\$103.10	\$98.51	74
400 - 430	DC - 10	3.5	5	-123	-25	0.1	0.05	PE1V12005	\$114.55	\$108.82	\$103.10	\$98.51	75
430 - 470	DC - 10	3.5	5	-122	-25	0.2	0.05	PE1V12006	\$114.55	\$108.82	\$103.10	\$98.51	76
465 - 525	DC - 15	3.5	5	-122	-18	0.1	0.2	PE1V12007	\$119.02	\$113.07	\$107.12	\$102.36	77
650 - 700	DC - 10	7.5	8	-121	-25	0.2	0.1	PE1V12008	\$114.55	\$108.82	\$103.10	\$98.51	78

0.5" Hermetically Sealed MIL Grade Surface Mount Packaged VCO



Frequency (MHz.)	Tuning Voltage (Vdc)	Output Power Typ (dBm)	Supply Voltage (Vdc)	Phase Noise* (dBc/Hz)	2nd Harmonics Typ (dBc)	Pushing Typ (MHz.)	Pulling Typ (MHz.)	Model No	1-9	10-24	25-49	50+	R O W
10 - 20	DC - 20	10	15	-120	-11	0.02	0.05	PE1V13000	\$426.88	\$405.54	\$384.19	\$367.12	79
18 - 30	DC - 12	12	12	-120	-13	0.03	0.07	PE1V13001	\$426.88	\$405.54	\$384.19	\$367.12	80
25 - 50	0.5 - 20	11.5	15	-114	-10	0.1	0.1	PE1V13002	\$426.88	\$405.54	\$384.19	\$367.12	81
30 - 60	DC - 15	11	15	-119	-14	0.05	0.05	PE1V13003	\$426.88	\$405.54	\$384.19	\$367.12	82
40 - 80	DC - 20	12	15	-117	-14	0.05	0.05	PE1V13004	\$426.88	\$405.54	\$384.19	\$367.12	83

* Phase Noise measured at 10 KHz offset frequency

0.5" Hermetically Sealed MIL Grade Surface Mount Packaged VCO



Frequency (MHz.)	Tuning Voltage (Vdc)	Output Power Typ (dBm)	Supply Voltage (Vdc)	Phase Noise* (dBc/Hz)	2nd Harmonics Typ (dBc)	Pushing Typ (MHz.)	Pulling Typ (MHz.)	Model No	1-9	10-24	25-49	50+	ROW
40 - 100	DC - 20	11.5	15	-118	-14	0.2	0.1	PE1V13005	\$426.88	\$405.54	\$384.19	\$367.12	84
50 - 100	DC - 20	12	15	-115	-12	0.05	0.1	PE1V13006	\$426.88	\$405.54	\$384.19	\$367.12	85
60 - 120	DC - 18.5	11	15	-114	-20	0.2	0.1	PE1V13007	\$426.88	\$405.54	\$384.19	\$367.12	86
75 - 150	DC - 18	11	15	-110	-20	0.2	0.4	PE1V13008	\$426.88	\$405.54	\$384.19	\$367.12	87
100 - 200	DC - 18	11	15	-113	-12	0.2	0.1	PE1V13009	\$426.88	\$405.54	\$384.19	\$367.12	88
150 - 300	DC - 20	11	15	-108	-14	1	2	PE1V13010	\$426.88	\$405.54	\$384.19	\$367.12	89
200 - 400	DC - 20	11	15	-106	-14	0.4	0.2	PE1V13011	\$443.53	\$421.35	\$399.18	\$381.44	90
400 - 800	DC - 9	8	5	-96	-14	3	1.3	PE1V13012	\$426.88	\$405.54	\$384.19	\$367.12	91
1,200 - 1,800	DC - 20	11	15	-89	-12	0.5	3	PE1V13013	\$426.88	\$405.54	\$384.19	\$367.12	92
3,000 - 3,500	DC - 10	10	11	-81	-16	2.5	12	PE1V13014	\$443.53	\$421.35	\$399.18	\$381.44	93
3,700 - 4,350	DC - 7.5	4	8	-83	-25	6	15	PE1V13015	\$443.53	\$421.35	\$399.18	\$381.44	94

Connectorized Packaged VCO w/ Field Replaceable Connectors

Commercial Standard



Frequency (MHz.)	Tuning Voltage (Vdc)	Output Power Typ (dBm)	Supply Voltage (Vdc)	Phase Noise* (dBc/Hz)	2nd Harmonics Typ (dBc)	Pushing Typ (MHz.)	Pulling Typ (MHz.)	Model No	1 Pc. Price	See Web for Volume Pricing			ROW
18 - 30	0.5 - 12	12	12	-120	-13	0.03	0.07	PE1V31000	\$389.75	See Web for Volume Pricing			95
25 - 50	0.5 - 15	11.5	15	-120	-12	0.05	0.03	PE1V31001	\$392.32				96
30 - 60	0.5 - 15	11	15	-119	-14	0.05	0.05	PE1V31002	\$392.32				97
40 - 80	0.5 - 20	12	15	-117	-14	0.05	0.05	PE1V31003	\$392.32				98
40 - 100	0.5 - 20	11.5	15	-118	-14	0.2	0.1	PE1V31004	\$377.59				99
50 - 100	0.5 - 20	12	15	-115	-12	0.05	0.1	PE1V31005	\$392.32				1
60 - 120	0.5 - 18.5	11	15	-114	-20	0.2	0.1	PE1V31006	\$392.32				2
75 - 150	0.5 - 18	11	15	-110	-20	0.2	0.4	PE1V31007	\$377.59				3
100 - 200	0.5 - 18	11	15	-113	-12	0.2	0.1	PE1V31008	\$392.32				4
200 - 400	0.5 - 20	11	15	-106	-14	0.4	0.2	PE1V31009	Call				5
400 - 800	0.5 - 13	12	10	-94	-20	0.6	0.7	PE1V31010	Call				6
1,200 - 1,800	0.5 - 20	11	15	-89	-12	0.5	3	PE1V31011	Call				7
3,000 - 3,500	0.5 - 10	10	11	-81	-16	2.5	12	PE1V31013	\$392.32	8			

Hi-REL Hermetic Buffer Amp



Frequency (MHz.)	Tuning Voltage (Vdc)	Output Power Typ (dBm)	Supply Voltage (Vdc)	Phase Noise* (dBc/Hz)	2nd Harmonics Typ (dBc)	Pushing Typ (MHz.)	Pulling Typ (MHz.)	Model No	1	2-4	5-9	10+	ROW
4,000 - 8,000	DC - 18	20	12	-75	-10	0.2	1	PE1V34000	\$4,887.05	\$4,716.00	\$4,544.96	\$4,398.35	9
5,000 - 10,000	DC - 20	20	12	-64	-15	0.2	1	PE1V34001	\$5,638.74	\$5,413.19	\$5,187.64	\$4,962.09	10
8,000 - 12,500	DC - 13	21	12	-59	-20	0.2	2	PE1V34002	\$6,281.25	\$6,030.00	\$5,778.75	\$5,527.50	11
38,400 - 43,200	DC - 13	13	5	-74	-30	40	0.01	PE1V34003	\$9,825.30	\$9,432.29	\$9,039.28	\$8,646.26	12

Reference Oscillators



Loop Type	Out Freq (MHz)	Ref. Type	Out Power Typ (dBm)	2nd Harmonics Typ (dBc)	Spurious Typ (dBc)	Ph Noise @100kHz Offset (dBc/Hz)	Package Type	Model No	1	2-4	5-9	10+	ROW
Free Running	10	Internal	7	-25		-150	Connectorized	PE19XR1003	\$1,796.12	\$1,724.28	\$1,652.43	\$1,580.59	13

* Phase Noise measured at 10 KHz offset frequency

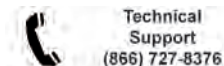

Technical Support
(866) 727-8376



Same-Day Shipping,
Even Custom
Cable Assemblies

See Our Website For Current Pricing & Real-Time Stock Availability!

Synthesizers & Oscillators

Reference Oscillators



Loop Type	Out Freq (MHz)	Ref. Type	Out Power Typ (dBm)	2nd Harmonics Typ (dBc)	Spurious Typ (dBc)	Ph Noise @ 100kHz Offset (dBc/Hz)	Package Type	Model No	1 Pc. Price	See Web for Volume Pricing	R O W
Free Running	10	Internal	7	-20		-145	Surface Mount	PE19XR1000	\$382.06	See Web for Volume Pricing	14
	50			Connectorized			PE19XR1004	\$1,970.25	15		
				Surface Mount			PE19XR1001	\$401.11	16		
	100			Connectorized			PE19XR1005	\$2,163.70	17		
				Surface Mount			PE19XR1002	\$463.64	18		

TCXO Oscillators

CMOS



Output Freq. (GHz)	High Level Out Voltage (V min)	Low Level Out Voltage (V max)	Temp Stability (+/- ppm)	Ph Noise @ 10kHz Offset (dBc/Hz)	Dimensions (in)	Model No	1-4	5-9	10-24	25+	R O W
10	4.9	0.1	2.5	-145	1.25x1.25x 0.563	PE19XL6000	\$711.44	\$675.87	\$640.30	\$611.84	19
20						PE19XL6001	\$684.74	\$650.50	\$616.27	\$588.88	20

Phase Locked Oscillators



Loop Type	Out Freq (MHz)	Ref. Type	Ref. Input Freq. (MHz.)	Out Power Typ (dBm)	2nd Harmonics Typ (dBc)	Spurious Typ (dBc)	Package Type	Model No	1 Pc. Price	See Web for Volume Pricing	R O W
Phase Locked	500	External	10	7	-35	-70	Connectorized	PE19XC7000	\$1,563.98	See Web for Volume Pricing	21
							Surface Mount	PE19XP5004	\$446.24		22
							Surface Mount	PE19XP5009	\$446.24		23
							Connectorized	PE19XC7005	\$1,505.27		24
							Connectorized	PE19XC7001	\$1,563.98		25
							Surface Mount	PE19XP5005	\$446.24		26
	Surface Mount				PE19XP5010		\$446.24	27			
	Connectorized				PE19XC7006		\$1,505.27	28			
	Surface Mount				PE19XP5006		\$625.53	29			
	Connectorized				PE19XC7002		\$1,791.29	30			
	Surface Mount				PE19XP5011		\$602.05	31			
	Connectorized				PE19XC7007		\$1,791.29	32			
	Connectorized				PE19XC7003		\$2,052.42	33			
	Surface Mount				PE19XP5007		\$685.58	34			
	Surface Mount				PE19XP5012		\$659.84	35			
	Connectorized				PE19XC7008		\$1,975.38	36			
	Connectorized				PE19XC7004		\$2,264.03	37			
	Surface Mount				PE19XP5008		\$724.83	38			
Surface Mount	PE19XP5013	\$724.83	39								
Connectorized	PE19XC7009	\$2,264.03	40								

Phase Locked Crystal Oscillators



Loop Type	Out Freq (MHz)	Ref. Type	Ref. Input Freq. (MHz)	Out Power Typ (dBm)	2nd Harmonics Typ (dBc)	Spurious Typ (dBc)	Package Type	Model No	1-4	5-9	10-24	25+	R O W
Phase-Locked Crystal	50	External	10	+7	-20	-70	Surface Mount	PE19XP5000	\$676.10	\$642.30	\$608.49	\$581.45	41

See Our Website For Current Pricing & Real-Time Stock Availability!

Synthesizers & Oscillators

Phase Locked Crystal Oscillators



Loop Type	Out Freq (MHz)	Ref. Type	Ref. Input Freq. (MHz)	Out Power Typ (dBm)	2nd Harmonics Typ (dBc)	Spurious Typ (dBc)	Package Type	Model No	1 Pc. Price	See Web for Volume Pricing	ROW
Phase-Locked Crystal	50	External	10	+7	-20	-70	Connectorized	PE19XP5002	\$2,420.04	See Web for Volume Pricing	42
	100						Surface Mount	PE19XP5001	\$799.98		43
							Connectorized	PE19XP5003	\$2,657.02		44

TAPPERS

Equal Split



Frequency Range (MHz.)	Maximum Power	Directivity (dB)	Model No	1-9	10-24	25-49	50+	ROW
376-2,200	500 Watt		PE-T1006	\$252.14	\$242.05	\$234.49	\$229.45	45
	700 Watt		PE-T1009	\$210.17	\$199.66	\$189.15	\$180.75	46
380-2,500	500 Watt		PE-T1013	\$274.54	\$263.56	\$255.32	\$249.83	47
			PE-T1000	\$196.37	\$188.52	\$182.62	\$178.70	48
600-2,700	300 Watt		PE20DV1026	\$208.40	\$197.98	\$187.56	\$179.22	49
			PE20DV1027	\$260.50	\$247.48	\$234.45	\$224.03	50
			PE20DV1028	\$236.20	\$224.39	\$212.58	\$203.13	51
			PE20DV1029	\$295.92	\$281.12	\$266.33	\$254.49	52
			PE20DV1030	\$257.04	\$244.19	\$231.34	\$221.05	53
			PE20DV1031	\$312.60	\$296.97	\$281.34	\$268.84	54
			PE-T1012	\$196.37	\$188.52	\$182.62	\$178.70	55
700-2,700	500 Watt		PE-T1003	\$176.41	\$167.59	\$158.77	\$151.71	56
			PE-T1008	\$240.93	\$228.88	\$216.84	\$207.20	57
			PE-T1010	\$201.69	\$191.61	\$181.52	\$173.45	58
			PE-T1011	\$263.34	\$250.17	\$237.01	\$226.47	59
			PE-T1002	\$206.76	\$198.49	\$192.29	\$188.15	60

Unequal Split



Frequency Range (MHz.)	Maximum Power	Directivity (dB)	Model No	1-9	10-24	25-49	50+	ROW		
350-5,850	300 Watt	2	PE-T2009	\$168.09	\$161.37	\$156.32	\$152.96	61		
			PE-T2013	\$192.23	\$182.62	\$173.01	\$165.32	62		
			PETP1001	\$243.13	\$230.97	\$218.82	\$209.09	63		
		3	PE-T2005	\$168.09	\$161.37	\$156.32	\$152.96	64		
			PE-T2014	\$151.36	\$143.79	\$136.22	\$130.17	65		
			PETP1002	\$201.45	\$191.38	\$181.31	\$173.25	66		
		4	PETP1003	\$243.13	\$230.97	\$218.82	\$209.09	67		
			PE-T2006	\$174.65	\$167.66	\$162.42	\$158.93	68		
			PETP1004	\$209.31	\$198.84	\$188.38	\$180.01	69		
			PETP1005	\$243.13	\$230.97	\$218.82	\$209.09	70		
		5	PE-T2003	\$174.65	\$167.66	\$162.42	\$158.93	71		
			PE-T2012	\$151.36	\$143.79	\$136.22	\$130.17	72		
			PETP1006	\$201.45	\$191.38	\$181.31	\$173.25	73		
		7	PETP1007	\$243.13	\$230.97	\$218.82	\$209.09	74		
			PE-T2002	\$168.09	\$161.37	\$156.32	\$152.96	75		
			PE-T2010	\$151.36	\$143.79	\$136.22	\$130.17	76		
			PETP1008	\$201.45	\$191.38	\$181.31	\$173.25	77		
					PETP1009	\$243.13	\$230.97	\$218.82	\$209.09	78

TAPPERS

Unequal Split



Frequency Range (MHz.)	Maximum Power	Directivity (dB)	Model No	1-9	10-24	25-49	50+	ROW
350-5,850	300 Watt	9	PE-T2007	\$254.32	\$241.60	\$228.89	\$218.72	79
			PETP1010	\$201.45	\$191.38	\$181.31	\$173.25	80
		12	PE-T2020	\$168.09	\$161.37	\$156.32	\$152.96	81
			PE-T2025	\$151.36	\$143.79	\$136.22	\$130.17	82
		15	PE-T2022	\$168.09	\$161.37	\$156.32	\$152.96	83
			PE-T2024	\$145.68	\$138.40	\$131.11	\$125.28	84
		19	PE-T2008	\$168.09	\$161.37	\$156.32	\$152.96	85
			PE-T2018	\$151.36	\$143.79	\$136.22	\$130.17	86
		24	PE-T2019	\$168.09	\$161.37	\$156.32	\$152.96	87
		30	PE-T2001	\$168.09	\$161.37	\$156.32	\$152.96	88
			PE-T2015	\$174.82	\$167.83	\$162.58	\$159.09	89
			PETP1012	\$201.45	\$191.38	\$181.31	\$173.25	90
			PETP1013	\$243.13	\$230.97	\$218.82	\$209.09	91
		39	PE-T2021	\$168.09	\$161.37	\$156.32	\$152.96	92
		100	PE-T2000	\$168.09	\$161.37	\$156.32	\$152.96	93
			PETP1014	\$201.45	\$191.38	\$181.31	\$173.25	94
			PETP1015	\$243.13	\$230.97	\$218.82	\$209.09	95
		1000	PE-T2004	\$168.09	\$161.37	\$156.32	\$152.96	96
			PE-T2023	\$236.45	\$224.63	\$212.81	\$203.35	97
			PETP1016	\$201.45	\$191.38	\$181.31	\$173.25	98
PETP1017	\$243.13		\$230.97	\$218.82	\$209.09	99		
380-6,000		100	PE-T2017	\$213.99	\$203.29	\$192.59	\$184.03	1
698-2,700		4	PE-T2011	\$151.36	\$143.79	\$136.22	\$130.17	2

INDEX GUIDE TO TERMINATIONS AND MATCHING PADS

Terminations & Matching Pads

TERMINATIONS AND MATCHING PADS.....307

MATCHING PADS.....311



Matching pads designed to mate with 50 ohm connectors on one end and 75 ohm connectors on the opposite end are available in a range of connector options.

Resistive Impedance Transformers.....311

TERMINATIONS.....307



RF Coaxial Terminations are available in a number of connector options and frequency ranges. Power ratings for these terminations range from 1/2 watt to 500 watts of continuous power. 50 ohm and 75 ohm options are available as well.

RF Load.....307 Feed-Thru Load.....310

TERMINATIONS

RF Load

50 Ohm



Max. Power (Watts)	Connector	Maximum Frequency.	Construction Material	VSWR Max.	Chain	Model No	1 Pc. Price	See Web for Volume Pricing	R O W	
0.25 W	Mini SMP Female	18 GHz	Gold Plated Beryllium Copper	1.35:1	No	PE6184	\$54.34	See Web for Volume Pricing	1	
		40 GHz		1.45:1	No	PE6182	\$154.55		2	
0.5 W	2.92mm Male	40 GHz	Passivated Stainless Steel	1.2:1	Yes	PE6086	\$396.98		3	
	2.92mm Female				No	PE6085	\$289.94		4	
	7/16 DIN Male	1,000 MHz	Tri-Metal Plated Brass	1.35:1	Yes	PE6088	\$434.50		5	
					No	PE6087	\$434.92		6	
	Mini SMP Male	40 GHz	Gold Plated Beryllium Copper	1.35:1	No	PE6146	\$129.65		7	
					Mini SMP Female	Gold over Nickel Plated Beryllium Copper	No		PE6163	\$251.14
	SMA Male	12.4 GHz	Passivated Stainless Steel	1.17:1	No	PE6162	\$285.50		9	
	SMA Female				Yes	PE6002	\$38.22		10	
	1 W	SMP Female	18 GHz	Gold Plated Beryllium Copper	1.35:1	No	PE6070		\$84.51	11
			26.5 GHz		1.3:1	No	PE6183		\$39.86	12
1.85mm Male		65 GHz	Passivated Stainless Steel	1.6:1	Yes	PE6181	\$104.71		13	
					No	PE6236	\$587.19		14	
2.4mm Male		50 GHz	Passivated Stainless Steel	1.45:1	Yes	PE6235	\$516.33		15	
					No	PE6179	\$552.75		16	
2.92mm Male		40 GHz	Passivated Stainless Steel	1.25:1	Yes	PE6178	\$499.60		17	
					No	PE6174	\$298.07		18	
2.92mm Female		18 GHz	Passivated Stainless Steel	1.25:1	Yes	PE6173	\$237.67		19	
BMA Plug					No	PE6175	\$332.10		20	
BMA Jack	6 GHz	Gold Plated Brass	1.2:1	No	PE6TR1041	\$170.34	21			
Mini SMP Male				1.3:1	PE6TR1042	\$182.94	22			
Mini SMP Female	4 GHz	Gold Plated Brass	1.2:1	No	PE6TR1043	\$55.94	23			
MMCX Male				Yes	PE6TR1044	\$55.94	24			
2 W	QMA Male	6 GHz	Gold Plated Brass	1.35:1	No	PE6199	\$28.42		25	
	QN Male				Yes	PE6TR1050	\$15.70		26	
	SMA Male	4 GHz	Gold Plated Brass	1.2:1	Yes	PE6TR1051	\$22.62		27	
					No	PE6TR1038	\$50.53		28	
	SMA Male	6 GHz	Tri-Metal Plated Brass	1.1:1	No	PE6150	\$6.76		29	
					No	PE6241	\$15.53		30	
	SMA Male	8 GHz	Gold Plated Brass	1.2:1	No	PE6TR1014	\$8.62		31	
					Yes	PE6151	\$43.51		32	
	SMA Male	18 GHz	Passivated Stainless Steel	1.25:1	Yes	PE6069	\$61.65		33	
					No	PE6072	\$91.89		34	
SMA Female	26.5 GHz	Passivated Stainless Steel	1.25:1	Yes	PE6071	\$56.27	35			
				No	PE6078	\$114.73	36			
SMA Female	18 GHz	Passivated Stainless Steel	1.35:1	Yes	PE6077	\$105.98	37			
				No	PE6073	\$88.33	38			
SMA Female	26.5 GHz	Passivated Stainless Steel	1.35:1	Yes	PE6073	\$88.33	39			
				No	PE6080	\$165.35	40			
SMB Plug	4 GHz	Gold Plated Brass	1.2:1	No	PE6079	\$137.29	41			
SMB Jack				No	PE6TR1037	\$26.05	42			
SMC Plug	10 GHz	Gold Plated Brass	1.3:1	No	PE6TR002	\$11.54	43			
SMC Jack				No	PE6TR006	\$21.42	44			
SMP Male	18 GHz	Gold over Nickel Plated Brass	1.35:1	No	PE6TR005	\$9.22	45			
				Yes	PE6TR1039	\$55.94	46			
SMP Female	18 GHz	Gold over Nickel Plated Brass	1.2:1	No	PE6161	\$216.04	47			
				Yes	PE6TR1040	\$55.94	48			
SSMC Plug	10 GHz	Gold Plated Brass	1.2:1	No	PE6160	\$166.20	49			
				Yes	PE6243	\$27.10	50			
2.4mm Male	50 GHz	Passivated Stainless Steel	1.45:1	No	PE6227	\$324.17	51			
				No	PE6242	\$533.20	52			
2.4mm Female	40 GHz	Passivated Stainless Steel	1.25:1	Yes	PE6180	\$601.10	53			
				No	PE6177	\$402.89	54			
2.92mm Male	40 GHz	Passivated Stainless Steel	1.25:1	Yes	PE6176	\$355.22	55			
				No	PE6TR1045	\$46.92	56			
4.3-10 Male	6 GHz	Passivated Stainless Steel	1.15:1	Yes	PE6TR1046	\$45.16	57			
				No	PE6TR1047	\$52.10	58			
4.3-10 Female	6 GHz	Passivated Stainless Steel	1.15:1	Yes	PE6TR1048	\$52.10	59			
				No	PE6TR1049	\$50.53	60			
7/16 DIN Male	3 GHz	Silver Plated Brass	1.1:1	No	PE6190	\$66.34	61			
				Aluminum	Yes	PE6TR1013	\$68.97	61		

Terminations & Matching Pads

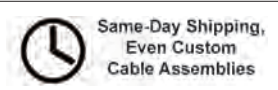
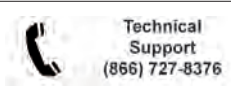

RF Load

50 Ohm



Max. Power (Watts)	Connector	Maximum Frequency.	Construction Material	VSWR Max.	Chain	Model No	1 Pc. Price	See Web for Volume Pricing	R O W	
2 W	7/16 DIN Male	6 GHz	Tri-Metal Plated Brass	1.2:1	No	PE6196	\$36.20	See Web for Volume Pricing	62	
	BNC Male	3 GHz		1.15:1	No	PE6TR007	\$18.55		63	
		4 GHz	Nickel Plated Brass	1.1:1	Yes	PE6TR008	\$20.16		64	
	No				PE6156	\$27.44	65			
	N Male	6 GHz	Tri-Metal Plated Brass	1.2:1	No	PE6154	\$38.02		66	
					Yes	PE6TR010	\$23.97		67	
					No	PE6248	\$27.89		68	
					No	PE6249	\$20.55		69	
		18 GHz	Nickel Plated Brass	1.3:1	No	PE6TR009	\$14.85		70	
					Yes	PE6TR012	\$23.21		71	
					No	PE6075	\$90.08		72	
					No	PE6009	\$57.49		73	
	N Female	6 GHz	Tri-Metal Plated Brass	1.2:1	No	PE6TR011	\$21.99		74	
		18 GHz	Nickel Plated Brass	1.3:1	Yes	PE6076	\$146.67		75	
	QMA Male	3 GHz			No	PE6032	\$83.47		76	
		6 GHz		1.1:1	No	PE6TR1052	\$16.31		77	
	SMA Male	18 GHz	Passivated Stainless Steel	1.3:1	No	PE6TR1036	\$35.93		78	
					Yes	PE6082	\$74.71		79	
		26.5 GHz	Gold Plated Stainless Steel	1.35:1	Yes	PE6081	\$54.65		80	
					No	PE6TR675	\$92.55		81	
					Yes	PE6TR677	\$89.08		82	
					No	PE6TR671	\$72.88		83	
		SMA Female	18 GHz	Passivated Stainless Steel	1.3:1	No	PE6TR673		\$75.78	84
						Yes	PE6084		\$102.86	85
		TNC Male	6 GHz	Tri-Metal Plated Brass	1.2:1	No	PE6083		\$74.62	86
						Yes	PE6TR014		\$13.45	87
	No					PE6172	\$19.40		88	
	18 GHz		Passivated Stainless Steel	1.25:1	No	PE6TR013	\$15.77		89	
Yes					PE6TR016	\$13.79	90			
No					PE6090	\$137.67	91			
TNC Female	6 GHz	Tri-Metal Plated Brass	1.3:1	No	PE6089	\$134.23	92			
				Yes	PE6229	\$31.00	93			
	18 GHz	Passivated Stainless Steel	1.25:1	No	PE6TR015	\$25.24	94			
				Yes	PE6092	\$219.56	95			
				No	PE6091	\$152.88	96			
				No						
5 W	2.92mm Male	40 GHz	Black Anodized Aluminum Heatsink	1.35:1	No	PE6TR028	\$752.86	97		
	7/16 DIN Male	7 GHz	Tri-Metal Plated Brass	1.25:1	No	PE6100	\$215.00	98		
	7/16 DIN Female				No	PE6139	\$213.74	99		
	N Male	3 GHz	Aluminum	1.15:1	No	PE6187	\$37.48	1		
		6 GHz			No	PE6186	\$83.29	2		
	N Female	18 GHz	Black Anodized Aluminum Heatsink	1.25:1	No	PE6097	\$144.75	3		
					No	PE6098	\$174.77	4		
					No	PE6095	\$122.84	5		
					No	PE6096	\$188.40	6		
					No	PE6099	\$178.29	7		
No					PE6138	\$206.76	8			
10 W	7/16 DIN Male	7 GHz		1.25:1	No	PE6105	\$334.71	9		
	7/16 DIN Female				No	PE6141	\$324.19	10		
	BNC Male	4 GHz		1.25:1	No	PE6034	\$179.47	11		
	BNC Female				No	PE6101	\$240.45	12		
	N Male	6 GHz	Black Anodized Aluminum Heatsink	1.15:1	No	PE6185	\$99.65	13		
					No	PE6035	\$261.18	14		
	N Female	18 GHz	Black Anodized Aluminum Heatsink	1.4:1	No	PE6102	\$293.74	15		
					No	PE6036	\$202.03	16		
					No	PE6103	\$271.56	17		
					No	PE6104	\$275.99	18		
No					PE6140	\$343.37	19			
No										
20 W	4.1/9.5 Mini DIN Male	2.7 GHz	Black Anodized Aluminum	1.33:1		PE6TR1022	\$451.09	20		
	4.3-10 Male				PE6TR1023	\$469.14	21			
	7/16 DIN Male				PE6TR1021	\$416.80	22			
	N Male				PE6TR1020	\$433.06	23			
25 W	7/16 DIN Male	7 GHz	Black Anodized Aluminum Heatsink	1.25:1	No	PE6107	\$444.80	24		
		8 GHz		1.6:1	No	PE6209	\$329.28	25		

Terminations & Matching Pads

RF Load

50 Ohm



Max. Power (Watts)	Connector	Maximum Frequency.	Construction Material	VSWR Max.	Chain	Model No	1 Pc. Price	See Web for Volume Pricing	ROW	
25 W	7/16 DIN Female	8 GHz	Black Anodized Aluminum Heatsink	1.6:1		PE6210	\$329.28	See Web for Volume Pricing	26	
	N Male	3 GHz		1.2:1	No	PE6228	\$140.03		27	
		1.6:1		PE6205	\$442.67	28				
	N Female	18 GHz		1.4:1	No	PE6106	\$475.62		29	
				1.6:1	PE6206	\$428.83	30			
				1.4:1	No	PE6037	\$569.58		31	
				1.6:1	PE6203	\$436.77	32			
				1.4:1	No	PE6204	\$397.71		33	
1.6:1			PE6038	\$515.35	34					
SMA Male	18 GHz	1.6:1	PE6207	\$469.00	35					
		1.4:1	No	PE6208	\$426.86	36				
30 W	SMA Female	4.2 GHz	Chem Film Plated Aluminum	1.25:1		PE6TR1000	\$360.77		37	
40 W	4.1/9.5 Mini DIN Male	2.7 GHz	Black Anodized Aluminum	1.15:1		PE6TR1026	\$627.93		38	
	4.3-10 Male					PE6TR1027	\$640.93		39	
	7/16 DIN Male					PE6TR1025	\$486.26		40	
	N Male					PE6TR1024	\$486.26		41	
50 W	7/16 DIN Male	2.7 GHz	Aluminum	1.2:1	No	PE6238	\$797.74		42	
		3 GHz	Black Anodized Aluminum Heatsink	1.15:1		PE6191	\$363.16		43	
		4 GHz		1.25:1	No	PE6169	\$488.77		44	
		8 GHz		1.6:1		PE6217	\$506.20		45	
	7/16 DIN Female	1.6:1			PE6218	\$579.08	46			
	N Male	3 GHz	1.1:1		PE6189	\$243.23	47			
		4 GHz	1.2:1		PE6188	\$353.76	48			
		8.5 GHz	1.3:1	No	PE6TR029	\$290.18	49			
		18 GHz	1.6:1		PE6213	\$510.17	50			
	N Female	3 GHz	1.25:1	Aluminum	1.25:1		PE6233		\$278.74	51
			1.1:1		PE6234	\$193.35	52			
		18 GHz	1.6:1	Black Anodized Aluminum Heatsink	1.6:1		PE6214		\$502.74	53
			1.45:1	No	PE6039	\$614.99	54			
		SMA Male	18 GHz	1.6:1		PE6211	\$517.62		55	
		SMA Female	3 GHz	Nickel Plated Brass	1.25:1		PE6232		\$209.59	56
	6 GHz		Chem Film Plated Aluminum	PE6TR1001		\$420.67	57			
18 GHz	1.6:1			PE6212		\$488.81	58			
	1.45:1		No	PE6040		\$685.78	59			
TNC Male	18 GHz	1.6:1		PE6215	\$476.00	60				
TNC Female	18 GHz	1.6:1		PE6216	\$516.52	61				
60 W	4.1/9.5 Mini DIN Male	2.7 GHz	Black Anodized Aluminum	1.15:1		PE6TR1030	\$555.73	62		
	7/16 DIN Male					PE6TR1029	\$671.24	63		
	N Male					PE6TR1028	\$538.36	64		
	4.3-10 Male					PE6TR1035A	\$902.19	65		
100 W	4.3-10 Female	2.7 GHz	Black Anodized Aluminum			PE6TR1035F	\$902.19	66		
						PE6TR1033A	\$781.50	67		
	7/16 DIN Male	3 GHz	Black Anodized Aluminum Heatsink	1.2:1	No	PE6197	\$358.68	68		
		8 GHz		1.5:1		PE6225	Call	69		
	7/16 DIN Female	2 GHz	1.35:1	No	PE6137	\$900.09	70			
		2.7 GHz	Black Anodized Aluminum		PE6TR1033F	\$781.50	71			
			Aluminum	1.2:1	No	PE6239	\$1,139.63	72		
		8 GHz	Black Anodized Aluminum Heatsink	1.5:1		PE6226	Call	73		
	BNC Female	2 GHz	1.2:1	No	PE6041	\$884.78	74			
	N Male	2.7 GHz	Black Anodized Aluminum		PE6TR1032A	\$781.50	75			
		4 GHz	Black Anodized Aluminum Heatsink		No	PE6168	\$546.41	76		
		8 GHz	1.5:1		PE6221	Call	77			
N Female	2.7 GHz	Black Anodized Aluminum		PE6TR1032F	\$811.98	78				
		Aluminum		PE6222	\$689.91	79				
SMA Male	8 GHz	Black Anodized Aluminum Heatsink	1.5:1		PE6219	\$726.32	80			
	2 GHz	1.3:1	No	PE6043	\$934.06	81				
SMA Female	6 GHz	Chem Film Plated Aluminum	1.25:1		PE6TR1002	\$436.88	82			
	8 GHz	Black Anodized Aluminum Heatsink	1.5:1		PE6220	\$648.50	83			
		1.5:1		PE6223	Call	84				
	TNC Female	8 GHz	Black Anodized Aluminum Heatsink	1.5:1		PE6224	Call	85		
								86		

See Web for Volume Pricing

Terminations & Matching Pads

RF Load

50 Ohm



Max. Power (Watts)	Connector	Maximum Frequency.	Construction Material	VSWR Max.	Chain	Model No	1 Pc. Price	See Web for Volume Pricing			ROW
150 W	SMA Female	3 GHz	Chem Film Plated Aluminum	1.3:1		PE6TR1003	\$368.32	See Web for Volume Pricing			87
200 W	N Male	3 GHz	Black Anodized Aluminum Heatsink	1.25:1	No	PE6230	\$589.92				88
	N Female					PE6231	\$611.37				89
300 W	N Female	3 GHz	Chem Film Plated Aluminum	1.3:1		PE6TR1004	\$546.17				90
500 W	N Female	1.2 GHz	Chem Film Plated Aluminum	1.25:1		PE6TR1005	\$539.68				91
800 W	N Female	500 MHz	Chem Film Plated Aluminum	1.5:1		PE6TR1006	\$672.33				92

75 Ohm



Max. Power (Watts)	Connector	Maximum Frequency.	Construction Material	VSWR Max.	Chain	Model No	1-24	25-49	50-99	100+	ROW
0.25 W	F Male	3 GHz	Nickel Plated Zinc			PE6202-100PK	\$72.44	\$68.82	\$65.20	\$62.30	93
						PE6202-25PK	\$20.84	\$19.80	\$18.76	\$17.92	94
						No	PE6202	\$1.18	\$1.12	\$1.06	\$1.01
1 W	BNC Male	1,000 MHz	Nickel Plated Brass		No	PE6165	\$16.32	\$15.50	\$14.69	\$14.04	96
		2 GHz	Tri-Metal Plated Brass	1.35:1	No	PE6TR004	\$62.72	\$59.58	\$56.45	\$53.94	97
2 W	BNC Female	2 GHz		1.15:1	No	PE6TR003	\$62.72	\$59.58	\$56.45	\$53.94	98

Feed-Thru Load

50 Ohm



Max. Power (Watts)	Connector Input	Connector Output	Maximum Frequency.	Construction Material	VSWR Max.	Chain	Model No	1 Pc. Price	See Web for Volume Pricing			ROW
2 W	BNC Male	BNC Female	1,000 MHz	Tri-Metal Plated Brass	1.3:1	No	PE6TR000	\$50.00	See Web for Volume Pricing			99
	N Male	N Female		Nickel Plated Brass	1.65:1	No	PE6033	\$146.67				1
	SMA Male	SMA Female		Passivated Stainless Steel	1.25:1	No	PE6026	\$89.13				2

75 Ohm



Max. Power (Watts)	Connector Input	Connector Output	Maximum Frequency.	Construction Material	VSWR Max.	Chain	Model No	1-24	25-49	50-99	100+	ROW
2 W	BNC Male	BNC Female	1,000 MHz	Tri-Metal Plated Brass	1.3:1	No	PE6TR001	\$35.47	\$33.70	\$31.92	\$30.50	3

Terminations & Matching Pads

Resistive Impedance Transformers



Model No	Connector A 50 Ω	Connector B 75 Ω	Max. Frequency (MHz.)	VSWR Max.	Attenuation Loss (dB)	Accuracy (dB)	1 Pc. Price	See Web for Volume Pricing			R O W
PE7006	BNC Male	BNC Female	2,000	1.2:1		±0.5	\$59.78	See Web for Volume Pricing			4
PE7007	BNC Male	BNC Female	2,000	1.2:1	6		\$58.18				5
PE7067	BNC Male	F Male	3,000	1.25:1	5.7	±0.5	\$119.78				6
PE7066	BNC Male	F Female	3,000	1.25:1		±0.5	\$136.12				7
PE7068	BNC Female	F Male	3,000	1.25:1		±0.5	\$129.83				8
PE7069	BNC Female	F Female	3,000	1.25:1	5.7	±0.5	\$126.76				9
PE7072	N Male	F Male	3,000	1.25:1		±0.5	\$139.79				10
PE70MP1002	N Male	F Female	3,000				\$97.05				11
PE7071	N Male	F Female	3,000	1.25:1		±0.5	\$105.16				12
PE7027	N Male	N Female	2,000	1.2:1		±0.5	\$119.58				13
PE7070	N Male	N Female	3,000	1.35:1		±0.5	\$119.97				14
PE7073	N Female	F Male	3,000	1.25:1		±0.5	\$109.79				15
PE70MP1001	N Female	F Female	3,000				\$159.00				16
PE7074	N Female	F Female	3,000	1.25:1		±0.5	\$143.69				17
PE7028	N Female	N Male	500	1.35:1		±0.5	\$26.97				18
PE7083	N Female	N Male	3,000	1.35:1		±0.5	\$159.32				19
PE70MP1007	SMA Male	F Male	3,000				\$97.05				20
PE7075	SMA Male	F Male	3,000	1.25:1		±0.5	\$128.95				21
PE70MP1006	SMA Male	F Female	3,000				\$97.05				22
PE7076	SMA Male	F Female	3,000	1.25:1		±0.5	\$109.71				23
PE70MP1005	SMA Female	F Male	3,000				\$97.05				24
PE7077	SMA Female	F Male	3,000	1.25:1		±0.5	\$106.11				25
PE70MP1004	SMA Female	F Female	3,000				\$97.05				26
PE7078	SMA Female	F Female	3,000	1.25:1		±0.5	\$119.79				27
PE7079	TNC Male	F Female	3,000	1.25:1	5.7	±0.5	\$159.00				28
PE7081	TNC Female	F Male	3,000	1.25:1	5.7	±0.5	\$159.00				29
PE7082	TNC Female	F Female	3,000	1.25:1	5.7	±0.5	\$109.00				30

Terminations &
Matching Pads

INDEX GUIDE TO TEST AND MEASUREMENT PRODUCTS

TEST AND MEASUREMENT PRODUCTS.....	312
<i>1.0MM FLEXIBLE VNA 110 GHZ PRECISION CABLES.....</i>	316
<i>26.5 GHZ & 40 GHZ TEST CABLES.....</i>	318
<i>4 - IN - 1 CALIBRATION KITS.....</i>	313
<i>40 GHZ SKEW MATCHED CABLES.....</i>	314
<i>50 GHZ & 67 GHZ TEST CABLE ASSEMBLIES.....</i>	315
<i>75 OHM TEST CABLE ASSEMBLIES.....</i>	318
<i>CALIBRATION KITS.....</i>	312
<i>COAXIAL RF PROBES & PROBE POSITIONING HARDWARE.....</i>	313
<i>HANDHELD RF ANALYZER RUGGED PHASE STABLE CABLE ASSEMBLIES.....</i>	314
<i>PE-TC151 SERIES PHASE STABLE TEST CABLE ASSEMBLIES.....</i>	317
<i>PE-TC195 SERIES PHASE STABLE TEST CABLE ASSEMBLIES.....</i>	317
<i>RUGGEDIZED VNA CABLE ASSEMBLIES.....</i>	315
<i>SEMI-RIGID PIGTAIL TEST PROBES.....</i>	318
<i>VNA TEST CABLES.....</i>	313

CALIBRATION KITS

Bench Type Calibration Kits



Connector Series	Impedance (Ohms)	Frequency Range (GHz)	Cal Type	Model No	1 Pc. Price	See Web for Volume Pricing	R O W
2.4mm	50	DC to 50	SOL	PE5CK1015	\$8,300.00	See Web for Volume Pricing	1
			SOLT	PE5CK1016	\$11,178.70		2
2.92mm		DC to 40	SOL	PE5CK1017	\$11,987.00		3
			SOLT	PE5CK1018	\$13,953.50		4
3.5mm		DC to 8.5	SOLT	PE5CK1001	\$3,475.58		5
			SOL	PE5500-KIT	Call		6
			SOLT	PE5CK1000	\$5,246.17		7
			SOL	PE5CK1019	\$6,792.00		8
			SOLT	PE5CK1020	\$7,406.70		9
7/16 DIN		DC to 7.5	SOL	PE5CK1021	\$8,864.50		10
			SOLT	PE5CK1022	\$13,091.00		11
7mm		DC to 18	SOL	PE5CK1023	\$6,122.57		12
BNC				PE5CK1024	\$7,362.32		13
N		DC to 18	SOLT	PE5501-KIT	Call		14
				PE5CK1025	\$5,070.79		15
	PE5CK1026			\$6,955.00	16		
F	75	DC to 3	SOLT	PE5CK1002	\$2,598.33	17	
				PE70MP5000	\$4,496.55	18	

Test & Measurement

VNA TEST CABLES

For Use With Interchangeable Connectors



Impedance (Ohms)	Connector Series	Frequency Range (GHz)	Type	Model No	1	2-4	5-9	10+	ROW
50	3.5mm NMD Female	DC - 26.5	Cable for Interchangeable Connectors	PE310-KIT	\$5,119.68	\$4,940.49	\$4,761.30	\$4,607.71	19

Interchangeable Connectors



Impedance (Ohms)	Connector Series	Frequency Range (GHz)	Gender	Polarity	Type	Model No	1 Pc. Price	See Web for Volume Pricing	ROW
50	3.5mm	DC - 26.5	Female	Standard	Connector	PE44488	Call	See Web for Volume Pricing	20
			Male			PE44487	\$686.25		21
	N	DC - 18	Female			PE44486	Call		22
			Male			PE44485	Call		23

4 - IN - 1 CALIBRATION KITS

Product Features

- Lightweight Portable 4-in-1 Package
- Precision 3.5mm Connectors
- Gold Plated Short Open Load Thru
- Supports 26.5 GHz SOLT Calibration
- Calibration Coefficients on Data Sheet



Connector 1	Impedance (Ohms)	Freq. Range (GHz)	Weight (lbs.)	Model No	1	2-4	5-9	10+	ROW
3.5mm Female Short Open Load Thru	50	DC to 26.5	2.752	PE5CK1012	\$3,890.73	\$3,735.10	\$3,579.47	\$3,423.84	24
3.5mm Male Short Open Load Thru				PE5CK1013	\$3,941.49	\$3,783.83	\$3,626.17	\$3,468.51	25

COAXIAL RF PROBES & PROBE POSITIONING HARDWARE

Product Features

PCB RF Probe Positioner (PE5TL1000): \$1,202.93

- RF PCB probe positioner holds coaxial probes
- Magnetic mounting plate
- On-Off positioner switch
- Articulated joints
- Multi-axis positioner control

Coaxial RF Microwave GS and GSG Probe Series (PE2PB1000-PE2PB1003):

- Max. Operating Frequency of 20 GHz
- RF probe Return Loss better than 10 dB
- GS and GSG Probes Feature Gold Plated Contacts
- Compliant coaxial GSG (or GS) pogo pins



RF MICROWAVE PROBES													ROW	
Probe Tip Config.	Number of Ground	Pitch 1 (µm)	Pitch 2 (µm)	Connector 1	Imp. (Ω)	Freq. Max (GHz)	RL Max (dB)	IL Max (dB)	Model No	1-4	5-9	10-24	25+	ROW
GS	1	800		2.92mm Female	50	10	10	0.5	PE2PB1006	\$843.90	\$801.71	\$759.51	\$725.75	26
				3.5mm Female					PE2PB1002	\$603.18	\$573.02	\$542.86	\$518.73	27
	2	1500	2,500	2.92mm Female					PE2PB1007	\$868.92	\$825.47	\$782.03	\$747.27	28
				3.5mm Female					PE2PB1003	\$621.06	\$590.01	\$558.95	\$534.11	29
GSG	2	800		2.92mm Female	50	10	0.5	PE2PB1004	\$906.62	\$861.29	\$815.96	\$779.69	30	
				3.5mm Female				PE2PB1000	\$647.87	\$615.48	\$583.08	\$557.17	31	
	4	1500	2,500	2.92mm Female				PE2PB1005	\$931.64	\$885.06	\$838.48	\$801.21	32	
				3.5mm Female				PE2PB1001	\$665.74	\$632.45	\$599.17	\$572.54	33	

40 GHZ SKEW MATCHED CABLES



Product Features

- 1 ps Delay match
- Excellent VSWR of 1.4:1
- 100% tested up to 40 GHz
- Extremely Flexible
- Polarity indicators on cable ends

Connector 1	Connector 2	Max Frequency (GHz)	Max VSWR	Typ Insertion Loss (dB/ft)	Model No	1	2-4	5-9	10+	ROW
2.92mm Male	2.92mm Male	40	1.4:1	1.4	PE3C4680-12	\$1,152.59	\$1,106.49	\$1,060.38	\$1,014.28	34
				2.8	PE3C4680-24	\$1,277.05	\$1,225.97	\$1,174.89	\$1,123.80	35
				5.6	PE3C4680-48	\$1,525.96	\$1,464.92	\$1,403.88	\$1,342.84	36

HANDHELD RF ANALYZER RUGGED PHASE STABLE CABLE ASSEMBLIES

Product Features

- Designed for in-field measurements with handheld or portable analyzers
- Excellent VSWR as low as 1.2:1
- Excellent Phase Stability with Flexure as low as 1.5 degrees
- Rugged Armor provides 1200 p.s.i crush resistance plus torque resistance
- UV resistance jacket
- Each assembly is serialized and includes test data



Connector 1	Connector 2	Freq. Max (GHz)	Imp (Ohm)	VSWR	IL @fmax (dB/ft)	Phase Stability with Flexure (Degrees)	Length (in)	Model No	1 Pc. Price	See Web for Volume Pricing	ROW			
N Male	7/16 DIN Male	7	50	1.2:1	2.16	1.5	60.0	PE3C4000-60	\$606.13	See Web for Volume Pricing	37			
	7/16 DIN Female				4.92		144.0	PE3C4000-144	\$794.81		38			
		N Male			2.16		60.0	PE3C4001-60	\$856.69		39			
	N Male Right Angle				4.92		144.0	PE3C4001-144	\$1,068.06					
		N Female			9		2.52	60.0	PE3C4002-60		\$494.77	40		
	5.74						144.0	PE3C4002-144	\$729.86					
	N Male	18			2.52		60.0	PE3C4003-60	\$760.79		41			
					5.74		144.0	PE3C4003-144	\$1,047.86					
	N Female	27			2.52		60.0	PE3C4004-60	\$494.77		42			
					5.74		144.0	PE3C4004-144	\$729.86					
	3.5mm Male	3.5mm Female			18		1.3:1	2.66	2.0		39.4	PE3C4005-100CM	\$637.06	43
											60.0	PE3C4006-100CM	\$804.09	
	3.5mm Female	27			3.89		3.89	3.89	4.0		39.4	PE3C4007-100CM	\$637.06	44
											60.0	PE3C4008-60	\$689.65	
	3.5mm Male	3.5mm Female			18		1.3:1	2.66	2.0		60.0	PE3C4009-60	\$689.65	45
											60.0	PE3C4010-60	\$964.95	
3.5mm Female	27	3.89	3.89	3.89	4.0	60.0	PE3C4011-60	\$964.95	46					
						60.0	PE3C4012-100CM	\$872.15						
3.5mm Male	3.5mm Female	18	1.3:1	2.66	2.0	39.4	PE3C4013-100CM	\$872.15	47					
						60.0	PE3C4014-100CM	\$872.15						

RUGGEDIZED VNA TEST CABLE ASSEMBLIES

See Our Website For Current Pricing & Real-Time Stock Availability!



Product Features

- Rugged VNA test port extenders
- Torsion resistant connector heads
- Max phase variation +/- 2° with flexure to 18 GHz
- Max phase variation +/- 3° with flexure to 26.5 GHz
- Max phase variation +/- 5° with flexure to 40 GHz
- 5,000 mating cycles minimum
- 75,000 flexure cycles minimum
- Each cable is serialized and comes with RF test data
- SMA, Type-N, 2.92mm and 2.4mm configurations available

Pasternack's ruggedized VNA test cables are designed to provide customers with repeatable accurate VNA measurements. These test cables have excellent electrical properties including low insertion loss, low VSWR and phase stability of +/- 2° to 18 GHz with flexure. Torsion resistant connector heads are directly attached to stainless steel conduit style armoring providing a rugged design for up to 5,000 mating cycles with proper care. The cable armoring enhances amplitude and phase stability by preventing stress due to over bending while maintaining the flexibility required for testing in a lab environment. When used with the appropriate calibration kit these test cables effectively extend the test port of the VNA allowing for accurate measurements of devices that cannot be directly connected to a Network Analyzer test port.

Connector 1	Connector 2	Freq. Max (GHz)	Imp (Ohm)	VSWR	IL (dB/ft)	IL (dB/m)	Phase Stability with Flexure (Degrees)	Flex Cycles	Model No	1 Pc. Price	See Web for Volume Pricing	ROW
2.4mm Male	2.4mm Female	40	50	1.38:1	0.83	2.72	5	---	PE3VNA4005-24	\$2,114.23	See Web for Volume Pricing	51
	2.4mm Male								PE3VNA4004-24	\$1,972.35		52
2.92mm Male	2.92mm Female	26.5	1.25:1	0.64	2.1	3	PE3VNA2606-24	\$1,521.23	53			
		40	1.38:1	0.83	2.72	5	PE3VNA4002-24	\$1,987.98	54			
	2.92mm Male	26.5	1.25:1	0.64	2.1	3	PE3VNA2605-24	\$1,491.45	55			
		40	1.38:1	0.83	2.72	5	PE3VNA4001-24	\$1,925.46	56			
3.5mm Male	3.5mm Female	26.5	50	1.3:1	0.64	2.1	3	---	PE3VNA2604-24	\$1,491.45		57
	3.5mm Male								PE3VNA2603-24	\$1,461.69		58
N Male	N Female	18	50	1.25:1	0.52	1.71	2	---	PE3VNA1804-24	\$806.69		59
	N Male								PE3VNA1803-24	\$791.80		60
SMA Male	SMA Female	18	50	1.25:1	0.52	1.71	2	---	PE3VNA1802-24	\$791.80		61
	SMA Male								PE3VNA1801-24	\$776.91		62

See Web for other lengths

50 AND 67 GHZ TEST CABLE ASSEMBLIES

Product Features

- Highly flexible VNA test cables up to 50 and 67 GHz
- Max phase variation +/- 6° to 50 GHz and +/- 8° to 67 GHz with flexure
- VSWR of 1.3:1 to 50 GHz and 1.4:1 to 67 GHz
- Rated up to 5,000 mating cycles
- Up to 100,000 flex cycles
- Swept right angle connector options available
- Highly flexible stainless steel braided armoring
- Designed for accurate and repeatable measurements



Test & Measurement

Connector 1	Connector 2	Freq. Max (GHz)	Imp (Ohm)	VSWR	IL @fmax (dB/ft)	Phase Stability with Flexure (Degrees)	Flex Cycles	Model No	1	2-4	5-9	10+	ROW
2.4mm Male	2.4mm Male	50	50	1.300	3.7	6.00	100,000	PE3TC0500-24	\$2,789.44	\$2,677.86	\$2,566.28	\$2,454.71	63
					7			PE3TC0500-48	\$2,932.19	\$2,814.90	\$2,697.61	\$2,580.33	

Continued on Next Page

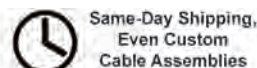
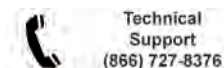

50 AND 67 GHZ TEST CABLE ASSEMBLIES

Product Features

- Highly flexible VNA test cables up to 50 and 67 GHz
- Max phase variation +/- 6° to 50 GHz and +/- 8° to 67 GHz with flexure
- VSWR of 1.3:1 to 50 GHz and 1.4:1 to 67 GHz
- Rated up to 5,000 mating cycles
- Up to 100,000 flex cycles
- Swept right angle connector options available
- Highly flexible stainless steel braided armoring
- Designed for accurate and repeatable measurements



Connector 1	Connector 2	Freq. Max (GHz)	Imp (Ohm)	VSWR	IL @fmax (dB/ft)	Phase Stability with Flexure (Degrees)	Flex Cycles	Model No	1	2-4	5-9	10+	ROW
2.4mm Male	2.4mm Female	50		1.300	3.7	6.00	100,000	PE3TC0600-24	\$2,789.44	\$2,677.86	\$2,566.28	\$2,454.71	64
					7			PE3TC0600-48	\$2,932.19	\$2,814.90	\$2,697.61	\$2,580.33	
	2.4mm Male Right Angle				3.7			PE3TC0700-24	\$3,262.51	\$3,132.01	\$3,001.51	\$2,871.01	65
					7			PE3TC0700-48	\$3,402.13	\$3,266.04	\$3,129.96	\$2,993.87	
1.85mm Male	1.85mm Male	67		1.400	4.3	8.00	100,000	PE3TC0800-24	\$2,884.71	\$2,769.32	\$2,653.93	\$2,538.54	66
					8.2			PE3TC0800-48	\$3,024.63	\$2,903.64	\$2,782.66	\$2,661.67	
	1.85mm Female				4.3			PE3TC0900-24	\$2,884.71	\$2,769.32	\$2,653.93	\$2,538.54	67
					8.2			PE3TC0900-48	\$3,024.63	\$2,903.64	\$2,782.66	\$2,661.67	
	1.85mm Male				4.3			PE3TC0800-500CM	Call	Call	Call	Call	68
					8.2			PE3TC1000-24	\$3,355.10	\$3,220.90	\$3,086.69	\$2,952.49	
	1.85mm Male Right Angle				8.2			PE3TC1000-48	\$3,498.00	\$3,358.08	\$3,218.16	\$3,078.24	69

1.0MM FLEXIBLE VNA 110 GHZ PRECISION CABLES

Product Features

- Operating to 110 GHz
- Lightweight, protective armoring
- Precision 1.0mm stainless steel connectors
- Non-conductive protective Nome® outer sleeve
- Easy assembly is serialized and includes test data



Connector 1	Connector 2	Freq. Max (GHz)	Imp (Ohm)	VSWR	IL @fmax (dB/ft)	Phase Stability with Flexure (Degrees)	Length (in)	Model No	1	2-4	5-9	10+	ROW
1.0mm Male	1.0mm Male	110	50	1.5	3.12	1.5	6.0	PE3TC1220-6	\$5,878.91	\$5,643.75	\$5,408.60	\$5,173.44	70
					5.62		PE3TC1220-12	\$7,867.15	\$7,552.46	\$7,237.78	\$6,923.09		
	1.0mm Female				3.12		PE3TC1221-6	\$5,878.91	\$5,673.15	\$5,467.39	\$5,291.02	71	
					5.62		PE3TC1221-12	\$6,136.39	\$5,921.62	\$5,706.84	\$5,522.75		

PE-TC195 SERIES PHASE STABLE TEST CABLE ASSEMBLIES

Product Features

- Phase and amplitude stability with flexure
- Small diameter, lighter weight and lower profile for high density test applications
- Phase change with flexure +/-2° to 18 GHz
- Excellent for multi-port test equipment
- Very flexible and durable cable with a min. bend radius of 1 inch
- Excellent VSWR and insertion loss
- Extra strain relief for extended connector body with booting to enhance stability and longevity
- Each serialized assembly comes with matching test data
- 5,000 mating cycles when properly mated
- In-Stock and ready to ship



See Our Website For Current Pricing & Real-Time Stock Availability!

Connector 1	Connector 2	Freq. Max (GHz)	Imp (Ohm)	VSWR	IL (dB/ft)	IL (dB/m)	Phase Stability with Flexure (Degrees)	Flex Cycles	Model No	1 Pc. Price	See Web for Volume Pricing	ROW
N Male	N Female	18	50	1.25:1	0.68	2.23	2	75,000	PE3TC0104-24	\$383.91	See Web for Volume Pricing	72
	N Male								PE3TC0103-24	\$340.60		73
SMA Male	SMA Female	27	2.06	6.76	3	PE3TC0105-24	\$329.78	74				
		18				PE3TC0102-24	\$356.84	75				
	SMA Male	27	0.68	2.23	2	PE3TC0202-24	\$553.52	76				
		18				PE3TC0101-24	\$313.54	77				
	27	2.06	6.76	3	PE3TC0201-24	\$454.28	78					

See Web for other lengths

PE-TC151 SERIES PHASE STABLE TEST CABLE ASSEMBLIES

Product Features

- Phase and amplitude stability with flexure
- Small diameter, lighter weight and lower profile for high density test applications
- Phase change with flexure +/-5° to 18 GHz
- Excellent for multi-port test equipment
- Very flexible and durable cable with a min. bend radius of 0.75 inches
- Excellent VSWR and insertion loss
- Extra strain relief for extended connector body with booting to enhance stability and longevity
- Each serialized assembly comes with matching test data
- 5,000 mating cycles when properly mated
- In-Stock and ready to ship



Connector 1	Connector 2	Freq. Max (GHz)	Imp (Ohm)	VSWR	IL (dB/ft)	IL (dB/m)	Phase Stability with Flexure (Degrees)	Flex Cycles	Model No	1-9	10-24	25+	ROW
N Male	N Male	18	50	1.3:1	0.85	2.79	5	75,000	PE3TC0302-24	\$278.24	\$264.33	\$250.42	79
									PE3TC0303-24	\$269.58	\$256.10	\$242.62	80
SMA Male	SMA Male	27	2.30	7.14	3.00	2.00	2	75,000	PE3TC0301-24	\$230.61	\$219.08	\$207.55	81
		18							PE3TC0401-24	\$390.84	\$371.30	\$351.76	82

See Web for other lengths

Test & Measurement

75 OHM TEST CABLE ASSEMBLIES



Product Features

- Phase and amplitude stability with flexure
- Small diameter, lighter weight and lower profile for high density test applications
- Very flexible and durable cable with a min. bend radius of 0.75 inches
- Each serialized assembly comes with matching test data

Connector 1	Connector 2	Freq. Max (GHz)	Imp (Ohm)	VSWR	IL (dB/ft)	IL (dB/m)	Phase Stability with Flexure (Degrees)	Flex Cycles	Model No	1-9	10-24	25+	ROW
N Male	F Male	3	75	1.16:1	0.193	0.63	5	100,000	PE3CA1031-60cm	\$262.32	\$249.20	\$236.09	83
	N Male								PE3CA1032-60cm	\$297.94	\$283.04	\$268.15	84

See Web for other lengths

SEMI-RIGID PIGTAIL TEST PROBES



Product Features

- Operating to 6 GHz
- SMA Female connectors
- Excellent VSWR of 1.3:1
- Straight-cut and pre-stripped probe ends available

Connector 1	Cable	Lead	Freq. Max (GHz)	Imp (Ohm)	VSWR	IL @fmax (dB/ft)	Length (in)	Model No	1-24	25-49	50-99	100+	ROW
SMA Female	PE-020SR	Straight Cut Lead	6	50	1.35:1	0.28	3.0	PE3CA1107-3	\$61.56	\$58.48	\$55.40	\$52.94	85
		Trimmed Lead						PE3CA1104-3	\$95.25	\$90.49	\$85.73	\$81.92	86
	PE-034SR	Straight Cut Lead						PE3CA1102-3	\$31.34	\$29.77	\$28.21	\$26.95	87
		Trimmed Lead						PE3CA1105-3	\$35.59	\$33.81	\$32.03	\$30.61	88
	PE-047SR	Straight Cut Lead						PE3CA1103-3	\$31.15	\$29.59	\$28.04	\$26.79	89
		Trimmed Lead						PE3CA1106-3	\$38.17	\$36.26	\$34.35	\$32.83	90

See Web for other lengths

26.5 GHZ & 40 GHZ TEST CABLES

Product Features



- Rugged Armored Jacket
- 1.38 Inch [3.5cm] Bend Radius
- RoHS Compliant



Connector 1	Connector 2	Freq. Max (GHz)	Imp (Ohm)	VSWR	IL @fmax (dB/ft)	Length (in)	Model No	1	2-4	5-9	10+	ROW
3.5mm Male	3.5mm Male	26.5	50	1.25	0.64	Various	PE3VNA2603	Call	Call	Call	Call	91
3.5mm Female	3.5mm Female			1.3			PE3VNA2604					92
2.92mm Male	2.92mm Male			1.25			PE3VNA2605					93
		40	1.38	0.83	PE3VNA2606	94						
PE3VNA4001	95											
PE3VNA4002	96											
PE3VNA4004	97											
2.4mm Male	2.4mm Male	40	50	1.38	0.83	Various	PE3VNA4005	98				
2.4mm Female	2.4mm Female											

INDEX GUIDE TO TOOLS

TOOLS.....	319
CABLE CUTTER.....	319
CRIMP TOOL DIES.....	321
CRIMP TOOLS.....	321
INSERTION / EXTRACTION TOOL.....	319
TORQUE WRENCHES.....	320

TOOLS							
Cable Cutter							
							
Type	Coax/Wire Type	Model No	1-24	25-49	50-99	100+	ROW
Cable Cutter	Coax	PE5200	\$103.09	\$97.94	\$92.78	\$88.66	1
Insertion/Extraction Tool							
							
Type	Connector Type	Model No	1-24	25-49	50-99	100+	ROW
Insertion/Extraction Tool	BNC	PE5014	Call	Call	Call	Call	2

Tools

Torque Wrenches



See Our Website For Current Pricing & Real-Time Stock Availability!

Type	Bit Hex Size	Preset Torque (in.-lbs)	Design	Model No	1-9	10-24	25-49	50+	R O W
1.0mm	15/64 inch	4	Break-Over	PE5019-16	\$224.24	\$213.03	\$201.82	\$192.85	3
3.5mm, 2.92mm	5/16 inch	8		PE5019-1	Call	Call	Call	Call	
		12		PE5019-2	Call	Call	Call	Call	
7mm	3/4 inch	14	Click Type	PE5011-3	\$364.86	\$346.62	\$328.37	\$313.78	4
N	20 mm	8.1	Break-Over	PE5019-5	\$224.24	\$213.03	\$201.82	\$192.85	3
		14	Click Type	PE5011-7	\$318.02	\$305.30	\$295.76	\$289.40	4
	25/32 inch		8.1	Break-Over	PE5019-6	\$222.15	\$211.04	\$199.94	\$191.05
3/4 inch	PE5019-3	\$222.15			\$211.04	\$199.94	\$191.05		
	N, 7mm	3/4 inch	14	Break-Over	PE5019-4	\$222.15	\$211.04	\$199.94	\$191.05
8.1			PE5019-7		\$222.15	\$211.04	\$199.94	\$191.05	
N, SC	13/16 inch	8.1	Click Type	PE5011-6	\$354.87	\$337.13	\$319.38	\$305.19	4
		14		Break-Over	PE5019-8	\$222.15	\$211.04	\$199.94	
SMA	5/16 inch	5	Break-Over		PE5019-19	Call	Call	Call	Call
SMA, 2.92mm		8		Click Type	PE5011-1	\$228.23	\$219.10	\$212.25	\$207.69
SMC	1/4 inch	3	Break-Over		PE5011-2	\$333.13	\$316.47	\$299.82	\$286.49
	15/64 inch			PE5019-11	\$224.24	\$213.03	\$201.82	\$192.85	
SSMA	1/4 inch	5	Click Type	PE5019-13	\$224.24	\$213.03	\$201.82	\$192.85	4
		8		PE5011-5	\$333.13	\$316.47	\$299.82	\$286.49	
		8.1		PE5019-14	\$224.24	\$213.03	\$201.82	\$192.85	
SSMC	5/32 inch	2	Break-Over	PE5019-12	\$222.15	\$211.04	\$199.94	\$191.05	3
TNC	5/8 inch	6.1		PE5019-18	\$239.94	\$227.94	\$215.95	\$206.35	
		12		PE5019-10	\$222.15	\$211.04	\$199.94	\$191.05	
		14	Click Type	PE5011-4	\$333.13	\$316.47	\$299.82	\$286.49	
9/16 inch	6.1	12	Break-Over	PE5019-17	\$224.24	\$213.03	\$201.82	\$192.85	3
				PE5019-9	\$222.15	\$211.04	\$199.94	\$191.05	
		13	Click Type	PE5011-8	\$314.28	\$298.57	\$282.85	\$270.28	4

Tools

Crimp Tools



Type	Hex Size (in.)	Compatible Dies	Cable Type	Model No	1 Pc. Price	See Web for Volume Pricing			ROW
Crimp Tools	0.068, 0.100, 0.128, 0.178	---	RG174, RG179, RG180, RG187, RG188, RG195, RG316	PE5006	Call				5
	0.068, 0.213, 0.255		RG55, RG58, RG59, RG62, RG142, RG223 RG400	PE5001	Call				6
	0.100, 0.429		RG9, RG11, RG87A, RG149, RG165, RG213, RG214, RG216, RG225, RG393	PE5007	\$169.45				7
Crimp Tool Kit	0.042, 0.068, 0.080, 0.100, 0.128, 0.151, 0.178, 0.213, 0.255, 0.324, 0.429	---	RG5, RG6, RG8, RG9, RG11, RG21, RG55, RG58, RG59, RG62, RG87A, RG140, RG141, RG142, RG143, RG165, RG174, RG179, RG180, RG187, RG188, RG195, RG210, RG212, RG213, RG214, RG216, RG222, RG223, RG225, RG303, RG304, RG316, RG393, RG400	PE5004-KIT	\$386.07				8
Crimp Tool, Scissor style, No Die	---	PE5010-1, PE5010-2, PE5010-3, PE5010-4, PE5010-5 and PE5010-6	---	PE5008	Call				9
Crimp Tool, Straight Style, No Die	---	PE5010-1, PE5010-2, PE5010-3, PE5010-4, PE5010-5 and PE5010-6	---	PE5009	Call				10
Crimp Tool for Compression Connectors	---	---	RG6, RG11, RG59	PE5012	\$151.70				11

Crimp Tool Dies



Type	Hex Size (in.)	Compatible Crimp Tools	Cable Type	Model No	1 Pc. Price	See Web for Volume Pricing			ROW
Dies, Crimp Tool	0.128, 0.100	PE5008 and PE5009	RG174, RG178, RG179, RG188, RG196, RG316	PE5010-2	Call				12
	0.213, 0.068		RG58, RG142, RG223, RG400	PE5010-1	Call				
	0.255, 0.068		RG8X, RG59, RG62, PE-C240	PE5010-3	Call				
	0.429, 0.100		RG8, RG213, RG214, PE-B400, PE-B405, PE-C400	PE5010-5	Call				

Tools

INDEX GUIDE TO WAVEGUIDE PRODUCTS

WAVEGUIDE ANTENNAS.....324

WAVEGUIDE ANTENNAS.....324 | **WG ANTENNA ACCESSORIES.....329**

Pasternack offers a large selection of waveguide antennas from WR-284 to WR-15 (2.6 GHz to 75 GHz) in a variety of flanges and gain. Both UG and CPR/CMR style flanges are available. Most of the gain horn antennas can be purchased already assembled with a waveguide to coax adapter.



WAVEGUIDE BENDS.....332



Pasternack offers a selection of E and H plane waveguide bends of various flanges and interfaces, covering the frequency range from 5.85 GHz to 18 GHz with VSWR as low as 1.08:1.

WAVEGUIDE FILTERS.....332

BANDPASS.....332

Pasternack offers a selection of high performance waveguide bandpass filters, covering the frequency range from 20.2 GHz to 40 GHz with WR-28 and WR-42 interfaces. These filters exhibit excellent out-of-band rejection making them ideally suited to receiver front-end or transmitter applications.



WAVEGUIDE BULKHEAD ADAPTERS.....333



The Pasternack series of rectangular waveguide bulkhead flange mount adapters are mounted to the panel of equipment with screws. Once mounted, waveguides flanges can be attached to the adapter on both sides of the bulkhead adapter to allow a signal path through the panel.

WAVEGUIDE CONVERTERS.....333

MIXER DOWN CONVERTERS.....333 | **MIXER UP CONVERTERS.....334**

Pasternack offers a series of Millimeter Wave Up and Down Converter Mixers that cover popular Ka, Q, U, V, E, and W Bands up to 110 GHz with an IF frequency of DC to 18 GHz. L and R ports support popular waveguide sizes from WR-28 to WR-10, and the IF port utilize Female SMA connectors.



WAVEGUIDE COUPLERS.....334

ASSEMBLIES.....339 | **BROADWALL.....334** | **CROSSGUIDE.....335**



Pasternack offers a brand new family of instrumentation grade directional waveguide couplers boasting accurate performance up to 110 GHz in seven popular frequency bands including K, Ka, Q, U, V, E and W bands. These waveguide couplers boast high directivity of 30 dB typical and insertion loss is as low as 0.6 dB in some models.

WAVEGUIDE DETECTORS.....339

Waveguide detectors consists of 6 unique models covering a broad frequency range of 26.5 GHz to 110 GHz. The input ports use popular waveguide sizes ranging from WR-28 to WR-10, while the video output ports utilize SMA female connectors. The detector circuits use high performance GaAs Schottky Barrier Beam lead diodes with extremely low junction capacitance.



WAVEGUIDE DIRECT READ ATTENUATORS.....340



These continuously variable attenuators have "direct read" capability which allows the user to dial-in the amount of attenuation needed to within 2% accuracy over most of the attenuation range. The attenuation level is stable, highly repeatable and accurate across the full frequency and attenuation range. These attenuators are ideal for precision measurements in demanding applications like instrumentation and system calibration.

WAVEGUIDE ELECTROMECHANICAL RELAY SWITCHES.....340

Pasternack offers a series of 28 waveguide electromechanical relay switch models that offer full waveguide performance covering C, X, Ku, K and Ka frequency bands from 5.85 GHz 40 GHz. These switches re configured for single-pole double-throw (SPDT) operation with latching self-cut-off actuators, TTL logic and position indicators with manual override.



FLEXIBLE WAVEGUIDES.....341

SEAMLESS.....341

TWISTABLE.....342

This family of flexible, seamless waveguides or flexible, twistable waveguides that can be bent in both the E and H planes without impairing VSWR or attenuation. These waveguides are covered by a neoprene jacket which protect the waveguide and provides mechanical support.



WAVEGUIDE ISOLATORS.....342



Pasternack Enterprises offers a wide variety of waveguide isolators from WR-10 to WR-112. These are two-port devices that transmit microwave or radio frequency power in one direction only and block the signal in the opposite direction.

WAVEGUIDE LOW NOISE AMPLIFIERS.....343

Pasternack Waveguide Low Noise Amplifiers are ruggedly built 50 ohm designs and unconditionally stable with impressive performance across broadband waveguide frequency bands



WAVEGUIDE MAGIC TEES.....343



Pasternack's magic, or hybrid tees are 4 port device that is internally tuned to optimize matching, balance, and isolation. A signal applied to the H port will be equally divided between the two collinear ports. A signal applied to the E port will be divided between the two collinear ports but with a 180 degree phase difference. Similarly, when two in-phase signals of equal amplitude are applied to the collinear ports, these will be added together at the H-plane (sum) port and subtracted from one another at the E-plane (difference) port.

WAVEGUIDE ORTHOMODE TRANSDUCERS.....343

These Orthomode Transducers are used for separating signals into two linear orthogonal signals. The OMT supports circular, elliptical and linear polarized waves. Pasternack's OMT line support from 8.2 to 90 GHz with 30-35 dB of isolation between ports.



WAVEGUIDE PHASE SHIFTERS.....343 WAVEGUIDE TERMINATIONS.....346



These waveguide variable phase shifters are built using low loss dielectric material, which offers minimum insertion loss..



Pasternack has a large family of high performance loads from WR-112 to WR-10. These standard terminations can dissipate up to 300 Watts of power depending on the specific band.

WAVEGUIDE PIN DIODE SWITCHES.....344 WAVEGUIDE TRANSITIONS.....347

Waveguide PIN Diode Switches consist of 4 models that cover 60 GHz to 110 GHz, in both SPST and SPDT configurations.



Pasternack's family of Waveguide Transitions/Adapters are used as a means of propagating RF/Microwave energy from one waveguide size to another.



WAVEGUIDE POLARIZERS.....344 WAVEGUIDE TWISTS.....348



Pasternack's Waveguide Polarizers transform polarized signals from circular to linear and vice versa. They can operate as either right hand or left hand polarization. Waveguide Polarizers currently cover Ku, Ka, and V bands.



Pasternack offers waveguide twists in 45 degree left and right hand waveguide versions as well at 90 degree. These twists are designed and constructed to prevent unwanted distortion to the signal's transmission.

WAVEGUIDE POWER AMPLIFIERS.....344 WAVEGUIDE VARIABLE ATTEN.....348

Waveguide Power Amplifiers consist of 2 models that cover 70.5 GHz to 86.5 GHz (E Band) and support WR-12 waveguide ports. Performance includes small signal gain that ranges from 20 to 22 dB.



The Continuously Variable attenuators are equipped with a micrometer, which enables rapid re-setting. With calibrated charts, attenuators can be used as direct reading attenuator for bench top test set use.



WAVEGUIDE SECTIONS.....345 WAVEGUIDE ACCESSORIES.....348



Pasternack offers a standard product line of waveguide straight section of various length and flanges, covering the frequency range from 5.85 GHz to 12.4 GHz with VSWR as low as 1.03:1.



Pasternack Enterprises offers a variety of waveguide accessories from WR-10 to WR-430.

WAVEGUIDE ANTENNAS

Waveguide Antennas With Coax Adapters

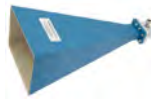

Waveguide Type	RF Frequency (GHz.)	Gain (dB)	Flange Type - Connector	ECCN	Model No	1	2-4	5-9	10+	R O W
WR-28	26.5 - 40	10	WR-28 - 2.92mm Female	EAR99	PE9850/2F-10	\$1,678.81	\$1,611.66	\$1,544.51	\$1,477.35	1
		15		EAR99	PE9850/2F-15	\$1,739.67	\$1,670.08	\$1,600.50	\$1,530.91	2
		20		EAR99	PE9850/2F-20	\$1,776.41	\$1,705.35	\$1,634.30	\$1,563.24	3
WR-34	22 - 33	10	WR-34 - 2.92mm Female	EAR99	PE9851/2F-10	\$1,710.56	\$1,642.14	\$1,573.72	\$1,505.29	4
		15		EAR99	PE9851/2F-15	\$1,864.00	\$1,789.44	\$1,714.88	\$1,640.32	5
		20		EAR99	PE9851/2F-20	\$1,991.00	\$1,911.36	\$1,831.72	\$1,752.08	6
WR-42	18 - 26.5	10	WR-42 - 2.92mm Female	EAR99	PE9852/2F-10	\$1,504.32	\$1,444.15	\$1,383.97	\$1,323.80	7
		15		EAR99	PE9852/2F-15	\$1,495.73	\$1,435.90	\$1,376.07	\$1,316.24	8
		20		EAR99	PE9852/2F-20	\$1,527.56	\$1,466.46	\$1,405.36	\$1,344.25	9
		15		EAR99	Call	Call	Call	Call	10	
WR-51	15 - 22	10	WR-51 - SMA Female	EAR99	PE9853/SF-10	\$1,321.51	\$1,268.65	\$1,215.79	\$1,162.93	11
		15		EAR99	PE9853/SF-15	\$1,635.27	\$1,569.86	\$1,504.45	\$1,439.04	12
		20		EAR99	PE9853/SF-20	\$1,621.76	\$1,556.89	\$1,492.02	\$1,427.15	13
WR-62	12.4 - 18	10	WR-62 - N Female	EAR99	PE9854/NF-10	\$1,225.45	\$1,176.43	\$1,127.41	\$1,078.40	14
		15		EAR99	PE9854/NF-15	\$1,313.05	\$1,260.53	\$1,208.01	\$1,155.48	15
		20		EAR99	PE9854/NF-20	\$1,350.22	\$1,296.21	\$1,242.20	\$1,188.19	16
		10	WR-62 - SMA Female	EAR99	PE9854/SF-10	\$1,312.81	\$1,260.30	\$1,207.79	\$1,155.27	17
		15		EAR99	PE9854/SF-15	\$1,355.59	\$1,301.37	\$1,247.14	\$1,192.92	18
		20		EAR99	PE9854/SF-20	\$1,293.72	\$1,241.97	\$1,190.22	\$1,138.47	19
WR-75	10 - 15	10	WR-75 - N Female	EAR99	PE9855/NF-10	\$1,332.60	\$1,279.30	\$1,225.99	\$1,172.69	20
		15		EAR99	PE9855/NF-15	\$1,243.95	\$1,194.19	\$1,144.43	\$1,094.68	21
		20		EAR99	PE9855/NF-20	\$1,354.17	\$1,300.00	\$1,245.84	\$1,191.67	22
		10	WR-75 - SMA Female	EAR99	PE9855/SF-10	\$1,306.04	\$1,253.80	\$1,201.56	\$1,149.32	23
		15		EAR99	PE9855/SF-15	\$1,306.09	\$1,253.85	\$1,201.60	\$1,149.36	24
		20		EAR99	PE9855/SF-20	\$1,315.58	\$1,262.96	\$1,210.33	\$1,157.71	25
WR-90	8.2 - 12.4	10	WR-90 - N Female	EAR99	PE9856/NF-10	Call	Call	Call	Call	26
		15		EAR99	PE9856/NF-15	\$1,248.74	\$1,198.79	\$1,148.84	\$1,098.89	27
		20		EAR99	PE9856/NF-20	\$1,334.35	\$1,280.98	\$1,227.60	\$1,174.23	28
		10	WR-90 - SMA Female	EAR99	PE9856/SF-10	\$1,276.43	\$1,225.37	\$1,174.32	\$1,123.26	29
		15		EAR99	PE9856/SF-15	\$1,181.12	\$1,133.88	\$1,086.63	\$1,039.39	30
		20		EAR99	PE9856/SF-20	\$1,273.12	\$1,222.20	\$1,171.27	\$1,120.35	31
WR-102	7 - 11	10	WR-102 - N Female	EAR99	PE9857/NF-10	\$1,327.50	\$1,274.40	\$1,221.30	\$1,168.20	32
		15		EAR99	PE9857/NF-15	\$1,267.83	\$1,217.12	\$1,166.40	\$1,115.69	33
		20		EAR99	PE9857/NF-20	\$1,492.80	\$1,433.09	\$1,373.38	\$1,313.66	34
		10	WR-102 - SMA Female	EAR99	PE9857/SF-10	\$1,487.44	\$1,427.94	\$1,368.44	\$1,308.95	35
		15		EAR99	PE9857/SF-15	\$1,303.36	\$1,251.23	\$1,199.09	\$1,146.96	36
		20		EAR99	PE9857/SF-20	\$1,514.49	\$1,453.91	\$1,393.33	\$1,332.75	37
WR-112	7.05 - 10	10	WR-112 - N Female	EAR99	PE9858/NF-10	\$1,438.95	\$1,381.39	\$1,323.83	\$1,266.28	38
		15		EAR99	PE9858/NF-15	\$1,191.44	\$1,143.78	\$1,096.12	\$1,048.47	39
		20		EAR99	PE9858/NF-20	\$1,368.99	\$1,314.23	\$1,259.47	\$1,204.71	40
		10	WR-112 - SMA Female	EAR99	PE9858/SF-10	\$1,429.87	\$1,372.68	\$1,315.48	\$1,258.29	41
		15		EAR99	PE9858/SF-15	\$1,271.97	\$1,221.09	\$1,170.21	\$1,119.33	42
		20		EAR99	PE9858/SF-20	\$1,414.53	\$1,357.95	\$1,301.37	\$1,244.79	43
WR-137	5.85 - 8.2	10	WR-137 - N Female	EAR99	PE9859/NF-10	\$1,389.55	\$1,333.97	\$1,278.39	\$1,222.80	44
		15		EAR99	PE9859/NF-15	\$1,344.20	\$1,290.43	\$1,236.66	\$1,182.90	45
		20		EAR99	PE9859/NF-20	\$1,451.65	\$1,393.58	\$1,335.52	\$1,277.45	46
		10	WR-137 - SMA Female	EAR99	PE9859/SF-10	\$1,484.29	\$1,424.92	\$1,365.55	\$1,306.18	47
		15		EAR99	PE9859/SF-15	\$1,465.18	\$1,406.57	\$1,347.97	\$1,289.36	48
		20		EAR99	PE9859/SF-20	\$1,522.76	\$1,461.85	\$1,400.94	\$1,340.03	49
WR-159	4.9 - 7.05	10	WR-159 - N Female	EAR99	PE9860/NF-10	\$1,462.63	\$1,404.12	\$1,345.62	\$1,287.11	50
		15		EAR99	PE9860/NF-15	\$1,579.57	\$1,516.39	\$1,453.20	\$1,390.02	51
		20		EAR99	PE9860/NF-20	\$1,759.65	\$1,689.26	\$1,618.88	\$1,548.49	52
		10	WR-159 - SMA Female	EAR99	PE9860/SF-10	\$1,800.39	\$1,728.37	\$1,656.36	\$1,584.34	53
		15		EAR99	PE9860/SF-15	\$1,624.35	\$1,559.38	\$1,494.40	\$1,445.67	54
		20		EAR99	PE9860/SF-20	\$1,752.95	\$1,682.83	\$1,612.71	\$1,542.60	55
WR-187	3.95 - 5.85	10	WR-187 - N Female	EAR99	PE9861/NF-10	\$1,710.56	\$1,642.14	\$1,573.72	\$1,505.29	56
		15		EAR99	PE9861/NF-15	\$1,473.93	\$1,414.97	\$1,356.02	\$1,297.06	57
		20		EAR99	PE9861/NF-20	\$1,949.39	\$1,871.41	\$1,793.44	\$1,715.46	58
		10	WR-187 - SMA Female	EAR99	PE9861/SF-10	\$2,033.26	\$1,951.93	\$1,870.60	\$1,789.27	59
		15		EAR99	PE9861/SF-15	\$1,829.16	\$1,755.99	\$1,682.83	\$1,609.66	60
		20		EAR99	PE9861/SF-20	\$2,006.37	\$1,926.12	\$1,845.86	\$1,765.61	61
WR-229	3.3 - 4.9	10	WR-229 - N Female	EAR99	PE9862/NF-10	\$1,964.54	\$1,885.96	\$1,807.38	\$1,728.80	62
		15		EAR99	PE9862/NF-15	\$1,677.01	\$1,609.93	\$1,542.85	\$1,475.77	63
		20		EAR99	PE9862/NF-20	\$2,209.42	\$2,121.04	\$2,032.67	\$1,944.29	64
		10	WR-229 - SMA Female	EAR99	PE9862/SF-10	\$2,022.75	\$1,941.84	\$1,860.93	\$1,780.02	65
		15		EAR99	PE9862/SF-15	\$2,257.95	\$2,167.63	\$2,077.31	\$1,987.00	66
		20		EAR99	PE-W229AN001/NF-10	Call	Call	Call	Call	67

Waveguide Antennas With Coax Adapters



Waveguide Type	RF Frequency (GHz.)	Gain (dB)	Flange Type - Connector	ECCN	Model No	1	2-4	5-9	10+	ROW
WR-229	3.3 - 4.9	10	WR-229 - SMA Female	EAR99	PE-W229AN001/SF-10	Call	Call	Call	Call	68
WR-284	2.6 - 3.95	10	WR-284 - N Female	EAR99	PE9863/NF-10	\$2,150.39	\$2,064.37	\$1,978.36	\$1,892.34	69
		20		EAR99	PE9863/NF-20	\$3,075.02	\$2,952.02	\$2,829.02	\$2,706.02	70
		10	WR-284 - SMA Female	EAR99	PE9863/SF-20	\$2,416.44	\$2,319.78	\$2,223.12	\$2,126.47	71
		20		EAR99	PE9863/SF-20	\$3,246.83	\$3,116.96	\$2,987.08	\$2,857.21	72
		15	WR-284 - N Female	EAR99	PEWAN1002	Call	Call	Call	Call	73
WR-430	1.7 - 2.6	10	WR-430 - N Female	EAR99	PE9864/NF-10	\$2,890.59	\$2,774.97	\$2,659.34	\$2,543.72	74
		15		EAR99	PE9864/NF-15	\$3,659.20	\$3,512.83	\$3,366.46	\$3,220.10	75
		20		EAR99	PE9864/NF-20	\$5,138.20	\$4,932.67	\$4,727.14	\$4,521.62	76
		10	WR-430 - SMA Female	EAR99	PE9864/SF-10	\$2,845.00	\$2,731.20	\$2,617.40	\$2,503.60	77
		15		EAR99	PE9864/SF-15	\$3,588.83	\$3,445.28	\$3,301.72	\$3,158.17	78
		20		EAR99	PE9864/SF-20	\$4,927.62	\$4,730.52	\$4,533.41	\$4,336.31	79

Standard Gain Horns



Waveguide Type	RF Frequency (GHz.)	Gain (dB)	Flange Type	ECCN	Model No	1 Pc. Price	See Web for Volume Pricing	ROW
WR-5	140 - 220	10	Round Cover UG-387/U-Mod	EAR99	PEWAN1029	\$2,062.50	See Web for Volume Pricing	80
		15		EAR99	PEWAN1030	\$2,062.50		81
		20		EAR99	PEWAN1031	\$2,062.50		82
		25		EAR99	PEWAN1032	\$2,131.25		83
WR-6	110 - 170	10		EAR99	PEWAN1025	\$1,687.50		84
		15		EAR99	PEWAN1026	\$1,712.50		85
		20		EAR99	PEWAN1027	\$1,737.50		86
		25		EAR99	PEWAN1028	\$2,013.06		87
WR-8	90 - 140	10		EAR99	PEWAN1021	\$1,437.50		88
		15		EAR99	PEWAN1022	\$1,462.50		89
		20		EAR99	PEWAN1023	\$1,487.50		90
		25		EAR99	PEWAN1024	\$1,875.00		91
WR-10	75 - 110	10	EAR99	PEWAN1017	\$1,187.50	92		
		15	EAR99	PEWAN1018	\$1,212.50	93		
		20	EAR99	PEWAN1019	\$1,285.76	94		
		25	EAR99	PEWAN1020	\$1,625.00	95		
WR-12	60 - 90	10	EAR99	PEWAN1013	\$1,233.81	96		
		15	EAR99	PEWAN1014	\$1,259.79	97		
		20	EAR99	PEWAN1015	\$1,285.76	98		
		25	EAR99	PEWAN1016	\$1,688.38	99		
WR-15	50 - 75	10	Round Cover UG-385/U-Mod	EAR99	PEWAN1009	\$1,187.50		1
		15		EAR99	PEWAN1010	\$1,259.79		2
		20		EAR99	PEWAN1011	\$1,237.50		3
		24	Round Cover UG-385/U	5A991	PE9881-24	\$1,479.18		4
		25	Round Cover UG-385/U-Mod	EAR99	PEWAN1012	\$1,688.38	5	
WR-19	40 - 60	10	Round Cover UG-383/U-Mod	EAR99	PEWAN1005	\$1,298.75	6	
		15		EAR99	PEWAN1006	\$1,350.00	7	
		20		EAR99	PEWAN1007	\$1,375.00	8	
		25		EAR99	PEWAN1008	\$1,625.00	9	
WR-28	26.5 - 40	10	Square Cover UG-599/U	EAR99	PE9850-10	\$866.19	10	
		15		EAR99	PE9850-15	\$1,039.00	11	
		20		EAR99	PE9850-20	\$980.59	12	
WR-34	22 - 33	10	Square Cover UG-1530/U	EAR99	PE9851-10	\$840.73	13	
		15		EAR99	PE9851A-15	\$967.00	14	
		20		EAR99	PE9851A-20	\$1,094.00	15	
WR-42	18 - 26.5	10	Square Cover UG-597/U	EAR99	PE9852-10	\$840.22	16	
		15		EAR99	PE9852A-15	\$845.04	17	
		20		EAR99	PE9852-20	\$1,069.57	18	
WR-51	15 - 22	10	Square Cover	EAR99	PE9853-10	\$756.23	19	
		15		EAR99	PE9853-15	\$994.61	20	
		20		EAR99	PE9853A-20	\$889.50	21	
WR-62	12.4 - 18	10	Square Cover	EAR99	PE9854-10	\$888.32	22	
		15		EAR99	PE9854-15	\$826.66	23	
		20		EAR99	PE9854-20	\$978.32	24	

See Our Website For Current Pricing & Real-Time Stock Availability!

Waveguides

Standard Gain Horns



See Our Website For Current Pricing & Real-Time Stock Availability!

Waveguide Type	RF Frequency (GHz.)	Gain (dB)	Flange Type	ECCN	Model No	1 Pc. Price	See Web for Volume Pricing	R O W
WR-75	10 - 15	10	Square Cover	EAR99	PE9855-10	\$888.32	See Web for Volume Pricing	25
		15		EAR99	PE9855-15	\$941.62		26
		20		EAR99	PE9855A-20	\$830.23		27
WR-90	8.2 - 12.4	10	Square Cover UG-135/U	EAR99	PE9856-10	\$852.45		28
		10	UG-135/U	EAR99	PE-W90AN001	Call		29
		15	Square Cover UG-135/U	EAR99	PE9856-15	\$966.84		30
20	EAR99	PE9856-20		\$1,038.70	31			
10	EAR99	PE9858-10		\$924.80	32			
WR-112	7.05 - 10	15	Square Cover	EAR99	PE9858-15	\$994.61		33
		20		EAR99	PE9858A-20	\$925.08		34
		10		EAR99	PE9857-10	\$840.73		35
WR-102	7 - 11	15		EAR99	PE9857-15	\$845.04		36
		20		EAR99	PE9857-20	\$856.11		37
		10		EAR99	PE9859-10	\$864.30		38
WR-137	5.85 - 8.2	15	CMR-137	EAR99	PE9859-15	\$920.71		39
		20		EAR99	PE9859-20	\$889.50		40
		10	CMR-159	EAR99	PE9860-10	\$914.71		41
WR-159	4.9 - 7.05	15	Square Cover UG-1731/U	EAR99	PE9860-15	\$983.44		42
		20	CMR-159	EAR99	PE9860-20	\$993.24		43
		10		EAR99	PE9861-10	\$856.11		44
WR-187	3.95 - 5.85	15	CMR-187	EAR99	PE9861-15	\$1,183.82		45
		20		EAR99	PE9861-20	\$1,209.93		46
		10		EAR99	PE-W229AN001	\$1,010.46		47
WR-229	3.3 - 4.9	15	CMR-229	EAR99	PE9862-15	\$1,265.10		48
		20		EAR99	PE9862-20	\$1,586.41		49
		10		EAR99	PE9863-10	\$1,296.57		50
WR-284	2.6 - 3.95	15	CMR-284	EAR99	PEWAN1001	\$1,284.21		51
		20		EAR99	PE9863-20	\$2,158.67		52
		10		EAR99	PE9864-10	\$1,700.25		53
WR-430	1.7 - 2.6	15	CPR-430F	EAR99	PE9864-15	\$2,309.74		54
		20		EAR99	PE9864-20	\$3,963.60	55	

Conical Gain Horns



Waveguide Type	RF Frequency (GHz.)	Gain (dB)	Flange Type	ECCN	Model No	1 Pc. Price	See Web for Volume Pricing	R O W
WR-5	140 - 220	10	Round Cover UG-387/U	EAR99	PEWAN1065	\$2,012.50	See Web for Volume Pricing	56
		15		EAR99	PEWAN1066	\$2,037.50		57
		20		EAR99	PEWAN1067	\$2,062.50		58
		25		EAR99	PEWAN1068	\$2,214.37		59
WR-6	100 - 112	10	Round Cover UG-387/U-Mod	EAR99	PEWAN1061	\$1,687.50		60
		15		EAR99	PEWAN1062	\$1,712.50		61
		20		EAR99	PEWAN1063	\$1,737.50		62
		25		EAR99	PEWAN1064	\$1,937.50		63
WR-8	100 - 112	10		EAR99	PEWAN1057	\$1,212.50		64
		15		EAR99	PEWAN1058	\$1,237.50		65
		20		EAR99	PEWAN1059	\$1,375.00		66
		25		EAR99	PEWAN1060	\$1,625.00		67
WR-10	87 - 100	10		EAR99	PEWAN1049	\$1,212.50		68
		15		EAR99	PEWAN1050	\$1,237.50		69
		20		EAR99	PEWAN1051	\$1,375.00		70
		25		EAR99	PEWAN1052	\$1,625.00		71
WR-12	77 - 87	10	Round Cover UG-387/U	EAR99	PEWAN1053	\$1,212.50		72
		15		EAR99	PEWAN1054	\$1,237.50		73
		20		EAR99	PEWAN1055	\$1,375.00		74
		25		EAR99	PEWAN1056	\$1,625.00		75
WR-12	68 - 77	10		EAR99	PEWAN1045	\$1,212.50		76
		15		EAR99	PEWAN1046	\$1,237.50		77
		20		EAR99	PEWAN1047	\$1,375.00		78
		25		EAR99	PEWAN1048	\$1,625.00		79
WR-12	68 - 77	10		EAR99	PEWAN1041	\$1,212.50		80
		15		EAR99	PEWAN1042	\$1,237.50		81

Waveguides

Conical Gain Horns



Waveguide Type	RF Frequency (GHz.)	Gain (dB)	Flange Type	ECCN	Model No	1	2-4	5-9	10+	ROW
WR-12	68 - 77	20	Round Cover UG-387/U	EAR99	PEWAN1043	\$1,375.00	\$1,326.88	\$1,278.75	\$1,237.50	82
		25		EAR99	PEWAN1044	\$1,625.00	\$1,568.13	\$1,511.25	\$1,462.50	83
WR-15	58 - 68	10	Round Cover UG-385/U	EAR99	PEWAN1037	\$1,212.50	\$1,170.06	\$1,127.63	\$1,091.25	84
		15		EAR99	PEWAN1038	\$1,237.50	\$1,194.19	\$1,150.88	\$1,113.75	85
		20		EAR99	PEWAN1039	\$1,375.00	\$1,326.88	\$1,278.75	\$1,237.50	86
		25		EAR99	PEWAN1040	\$1,625.00	\$1,568.13	\$1,511.25	\$1,462.50	87
WR-19	50 - 58	10	Round Cover UG-383/U-Mod	EAR99	PEWAN1033	\$1,100.00	\$1,061.50	\$1,023.00	\$990.00	88
		15		EAR99	PEWAN1034	\$1,237.50	\$1,194.19	\$1,150.88	\$1,113.75	89
		20		EAR99	PEWAN1035	\$1,375.00	\$1,326.88	\$1,278.75	\$1,237.50	90
		25		EAR99	PEWAN1036	\$1,625.00	\$1,568.13	\$1,511.25	\$1,462.50	91

Wide Angle Scalar Feed Horns



Waveguide Type	RF Frequency (GHz.)	Gain (dB)	Flange Type	ECCN	Model No	1	2-4	5-9	10+	ROW
WR-10	100 - 112	17	Round Cover UG-387/U-Mod	EAR99	PEWAN1109	\$5,125.00	\$4,945.63	\$4,766.25	\$4,612.50	92
		10	Round Cover UG-385/U-Mod	EAR99	PEWAN1073	\$4,725.00	\$4,559.63	\$4,394.25	\$4,252.50	93
		10		EAR99	PEWAN1074	\$3,325.00	\$3,208.63	\$3,092.25	\$2,992.50	94
WR-12	87 - 100	17	UG-387/U-Mod	EAR99	PEWAN1123	\$4,625.00	\$4,463.13	\$4,301.25	\$4,162.50	95
		17		EAR99	PEWAN1122	\$4,500.00	\$4,342.50	\$4,185.00	\$4,050.00	96
	72 - 82	10	Round Cover UG-385/U	EAR99	PEWAN1071	\$4,725.00	\$4,559.63	\$4,394.25	\$4,252.50	97
		10		EAR99	PEWAN1072	\$3,325.00	\$3,208.63	\$3,092.25	\$2,992.50	98
	68 - 77	17	UG-387/U-Mod	EAR99	PEWAN1120	\$4,500.00	\$4,342.50	\$4,185.00	\$4,050.00	99
		17	UG-385/U-Mod	EAR99	PEWAN1118	\$4,375.00	\$4,221.88	\$4,068.75	\$3,937.50	1
WR-15	55 - 65	10	Round Cover UG-385/U	EAR99	PEWAN1069	\$4,725.00	\$4,559.63	\$4,394.25	\$4,252.50	2
		10		EAR99	PEWAN1070	\$3,454.68	\$3,333.77	\$3,212.85	\$3,109.21	3
		17		UG-599/U	EAR99	PEWAN1115	\$4,000.00	\$3,860.00	\$3,720.00	\$3,600.00
17	EAR99	PEWAN1114	\$4,000.00		\$3,860.00	\$3,720.00	\$3,600.00	5		
WR-28	26 - 30	17	UG-599/U	EAR99	PEWAN1113	\$4,000.00	\$3,860.00	\$3,720.00	\$3,600.00	6
		16		Square Cover UG-1530/U	EAR99	PEWAN1110	\$4,000.00	\$3,860.00	\$3,720.00	\$3,600.00

Lens Gain Horns



Waveguide Type	RF Frequency (GHz.)	Gain (dB)	Flange Type	ECCN	Model No	1 Pc. Price	See Web for Volume Pricing			ROW
WR-10	89 - 99	34	Round Cover UG-387/U	EAR99	PEWAN1083	\$4,725.00				8
		34		EAR99	PEWAN1085	\$5,775.00				9
		40		EAR99	PEWAN1084	\$5,075.00				10
		40		EAR99	PEWAN1086	\$6,125.00				11
	88 - 100	48	Square Cover UG-387/U-Mod	EAR99	PEWAN1102	\$9,375.00				12
WR-12	72 - 82	32	Round Cover UG-387/U	EAR99	PEWAN1079	\$4,025.00	See Web for Volume Pricing			13
		32		EAR99	PEWAN1081	\$5,075.00				14
		37		EAR99	PEWAN1080	\$4,375.00				15
		37		EAR99	PEWAN1082	\$5,425.00				16
WR-15	55 - 65	32	Round Cover UG-385/U	EAR99	PEWAN1075	\$2,975.00				17
		32		EAR99	PEWAN1077	\$4,025.00				18
		37		EAR99	PEWAN1076	\$3,325.00				19
		37		EAR99	PEWAN1078	\$4,375.00				20

Omni Directional



Waveguide Type	RF Frequency (GHz.)	Gain (dB)	Flange Type	ECCN	Model No	1	2-4	5-9	10+	ROW
WR-10	90 - 100	0	Round Cover UG-387/U-Mod	EAR99	PEWAN1135	\$4,625.00	\$4,463.13	\$4,301.25	\$4,162.50	21
		6.5	Square Cover UG-387/U-Mod	EAR99	PEWAN1136	\$4,625.00	\$4,463.13	\$4,301.25	\$4,162.50	22
WR-12	89 - 99	2	Round Cover UG-387/U	EAR99	PEWAN1089	\$6,825.00	\$6,586.13	\$6,347.25	\$6,142.50	23
		2		EAR99	PEWAN1088	\$6,825.00	\$6,586.13	\$6,347.25	\$6,142.50	24
WR-15	75 - 79	2	Round Cover UG-387/U	EAR99	PEWAN1088	\$6,825.00	\$6,586.13	\$6,347.25	\$6,142.50	24
		2		EAR99	PEWAN1134	\$4,375.00	\$4,221.88	\$4,068.75	\$3,937.50	25
WR-15	58 - 62	3.5	Round Cover UG-385/U	EAR99	PEWAN1087	\$6,825.00	\$6,586.13	\$6,347.25	\$6,142.50	26
WR-28	26.5 - 40	7.5	Square Cover UG-599/U	EAR99	PEWAN1133	\$3,875.00	\$3,739.38	\$3,603.75	\$3,487.50	27

Probe Waveguide Antennas



Waveguide Type	RF Frequency (GHz.)	Gain (dB)	Flange Type	ECCN	Model No	1	2-4	5-9	10+	ROW
WR-6	110 - 170	6.5	Round Cover UG-387/U-Mod	EAR99	PEWAN1124	\$1,725.00	\$1,664.63	\$1,604.25	\$1,552.50	28
WR-8	90 - 140	6.5		EAR99	PEWAN1125	\$1,725.00	\$1,664.63	\$1,604.25	\$1,552.50	29
WR-10	75 - 110	6.5		EAR99	PEWAN1126	\$1,725.00	\$1,664.63	\$1,604.25	\$1,552.50	30
WR-12	60 - 90	6.5	Round Cover UG-387/U	EAR99	PEWAN1127	\$1,725.00	\$1,664.63	\$1,604.25	\$1,552.50	31
WR-15	50 - 75	6.5	Round Cover UG-385/U	EAR99	PEWAN1128	\$1,725.00	\$1,664.63	\$1,604.25	\$1,552.50	32
WR-19	40 - 60	6.5	Round Cover UG-383/U-Mod	EAR99	PEWAN1129	\$1,725.00	\$1,664.63	\$1,604.25	\$1,552.50	33
WR-22	33 - 50	6.5	Round Cover UG-383/U	EAR99	PEWAN1130	\$1,725.00	\$1,664.63	\$1,604.25	\$1,552.50	34
WR-28	26.5 - 40	6.5	Square Cover UG-599/U	EAR99	PEWAN1131	\$1,725.00	\$1,664.63	\$1,604.25	\$1,552.50	35
WR-34	22 - 33	6.5	Square Cover UG-1530/U	EAR99	PEWAN1132	\$1,725.00	\$1,664.63	\$1,604.25	\$1,552.50	36

Sector Waveguide Antennas



Waveguide Type	RF Frequency (GHz.)	Gain (dB)	Flange Type	ECCN	Model No	1	2-4	5-9	10+	ROW
WR-28	30 - 40	0	Square Cover UG-599/U-Mod	EAR99	PEWAN1144	\$3,200.00	\$3,088.00	\$2,976.00	\$2,880.00	37
	27.5 - 29.5	6	Square Cover UG-599/U	EAR99	PEWAN1143	\$3,200.00	\$3,088.00	\$2,976.00	\$2,880.00	38

Dual Polarized Scalar Feed Horns



Waveguide Type	RF Frequency (GHz.)	Gain (dB)	Flange Type	ECCN	Model No	1	2-4	5-9	10+	ROW
WR-10	75 - 110	13	UG-387/U-Mod	EAR99	PEWAN1121	\$18,875.00	\$18,214.38	\$17,553.75	\$16,987.50	39
		15	Square Cover UG-387/U-Mod	EAR99	PEWAN1137	\$8,625.00	\$8,323.13	\$8,021.25	\$7,762.50	40
		20		EAR99	PEWAN1141	\$8,625.00	\$8,323.13	\$8,021.25	\$7,762.50	41
WR-12	60 - 90	13	UG-387/U	EAR99	PEWAN1119	\$18,375.00	\$17,731.88	\$17,088.75	\$16,537.50	42
		15	Square Cover UG-387/U	EAR99	PEWAN1138	\$8,125.00	\$7,840.63	\$7,556.25	\$7,312.50	43
		15	Square Cover UG-385/U	EAR99	PEWAN1139	\$7,500.00	\$7,237.50	\$6,975.00	\$6,750.00	44
WR-15	50 - 75	13	UG-385/U-Mod	EAR99	PEWAN1117	\$18,875.00	\$18,214.38	\$17,553.75	\$16,987.50	45
WR-19	40 - 60	13	UG-383/U-Mod	EAR99	PEWAN1116	\$15,375.00	\$14,836.88	\$14,298.75	\$13,837.50	46
WR-22	33 - 50	15	Square Cover UG-383/U	EAR99	PEWAN1140	\$7,000.00	\$6,755.00	\$6,510.00	\$6,300.00	47
WR-28	24 - 42	10	Square Choke UG-599/U	EAR99	PEWAN1142	\$10,000.00	\$9,650.00	\$9,300.00	\$9,000.00	48
		15	UG-599/U	EAR99	PEWAN1112	\$12,750.00	\$12,303.75	\$11,857.50	\$11,475.00	49
	15	EAR99		PEWAN1111	\$11,500.00	\$11,097.50	\$10,695.00	\$10,350.00	50	

See Our Website For Current Pricing & Real-Time Stock Availability!

Waveguides

Specialty Waveguide Antennas



Waveguide Type	RF Frequency (GHz.)	Gain (dB)	Flange Type	ECCN	Model No	1	2-4	5-9	10+	ROW
Broadband	1 - 18		Round Cover - UG-385/U	EAR99	PE9887-11	\$3,531.52	\$3,407.92	\$3,284.31	\$3,178.37	51
		EAR99		PE9888-11	\$3,565.14	\$3,440.36	\$3,315.58	\$3,208.63	52	
WR-15	50 - 75	42	Round Cover - UG-385/U	5A991	PE9881-42	\$2,366.43	\$2,271.77	\$2,177.12	\$2,082.46	53
		20		EAR99	PE9881A-20	\$1,083.69	\$1,040.34	\$996.99	\$953.65	54
		56.5 - 67		5A991	PE9881-34	\$1,552.93	\$1,498.58	\$1,444.22	\$1,397.64	55

WAVEGUIDE ANTENNA ACCESSORIES

Waveguide to Coax Adapters



WG Type	RF Freq. (GHz.)	IL (dB)	Max VSWR	Flange Type	Connector	ECCN	Model No	1 Pc. Price	See Web for Volume Pricing	ROW
WR-10	75-110	1	1.32:1	Round Cover UG-387/U-Mod	1.0mm Female	EAR99	PE-W10CA003	\$5,210.00		56
			1.9:1		1.0mm Female	EAR99	PE-W10CA001	Call		57
WR-12	60-90	1.67:1	1.44:1	Round Cover UG-387/U	1.0mm Female	EAR99	PE-W10CA002	\$5,210.00		58
					1.0mm Male	EAR99	PE-W12CA001	\$5,199.79		59
WR-15	50-65	0.5	1.44:1	Round Cover UG-385/U	1.85mm Female	EAR99	PE-W12CA002	\$5,036.33		60
					1.85mm Male	EAR99	PE-W15CA001	\$1,403.93		61
WR-19	40-60	0.4	1.38:1	Round Cover UG-383/U-Mod	1.85mm Female	EAR99	PE-W15CA002	\$1,446.42		62
					1.85mm Male	EAR99	PE-W19CA001	\$1,509.18		63
WR-22	33-50	1.33:1	1.44:1	Round Cover UG-383/U	2.4mm Female	EAR99	PE-W19CA002	\$1,371.98		64
					2.4mm Male	EAR99	PE-W22CA001	\$1,564.80		65
					2.4mm Female	EAR99	PE-W22CA002	\$1,319.88		66
WR-28	26.5-40	0.3	1.25:1	Square Cover UG-599/U	2.92mm Female	EAR99	PEW22CA100	\$1,564.80	See Web for Volume Pricing	67
					2.92mm Male	EAR99	PEWCA1078	Call		68
					2.92mm Female	EAR99	PEWCA1079	\$762.91		69
					2.92mm Female	EAR99	PEWCA1000	\$856.89		70
					2.92mm Female	EAR99	PEWCA1020	\$719.45		71
WR-34	22-33	0.3	1.25:1	Square Cover	2.92mm Female	EAR99	PE9826	\$479.20		72
					2.92mm Female	EAR99	PEWCA1001	\$708.58		73
WR-42	18-26.5	0.75	1.25:1	Square Cover UG-597/U	2.92mm Female	EAR99	PEWCA1021	\$653.55		74
					2.92mm Female	EAR99	PE9827	\$844.10		75
					2.92mm Female	EAR99	PEWCA1026	\$658.03		76
WR-51	15-22	1.25:1	1.03:1	Square Cover UG-597/U	2.92mm Female	EAR99	PEWCA1019	\$522.59		77
					SMA Female	EAR99	PEWCA1018	\$741.91		78
					2.92mm Female	EAR99	PE-W42CA001	\$762.91		79
					2.92mm Male	EAR99	PEWCA1017	\$873.33		80
					2.92mm Female	EAR99	PEWCA1022	\$569.90		81
					SMA Female	EAR99	PEWCA1021	\$572.46		82
					2.92mm Male	EAR99	PE9878	\$572.46		83
					2.92mm Male	EAR99	PE9813A	\$610.70		84
					2.92mm Female	EAR99	PE9812	\$459.34		85
					SMA Female	EAR99	PEWCA1002A	\$527.96		86
WR-62	12.4-18	0.3	1.25:1	Square Cover UG-1665/U	SMA Female	EAR99	PEWCA1027	\$736.36		87
					SMA Female	EAR99	PE9828	\$564.89		88
					SMA Female	EAR99	PE9879	\$757.71		89
					SMA Male	EAR99	PE9809	\$377.25		90
					N Female	EAR99	PEWCA1028	\$649.58		91
	11.9-18	0.2	1.25:1	Square Cover UG-419/U	SMA Female	EAR99	PEWCA1023	\$536.99		92
					SMA Female	EAR99	PEWCA1003	\$498.01		93
					N Female	EAR99	PEWCA1097	Call		94
					SMA Female	EAR99	PEWCA1098	Call		95
					N Female	EAR99	PEWCA1072	\$849.00		96
12.4-18	0.3	1.3:1	Square Cover UG-1665/U	SMA Female	EAR99	PEWCA1071	\$750.00		97	
				SMA Female	EAR99	PE9803	\$381.14		98	
				N Male	EAR99	PE9806	\$619.41		99	
				N Female	EAR99	PE9866	\$669.91		1	
				N Female	EAR99	PE9875	\$360.83		2	
WR-75	10-15	1.25:1	Square Cover	SMA Female	EAR99	PE9846	\$558.27		3	
				N Female	EAR99	PEWCA1005	\$666.91		4	
				N Female	EAR99	PEWCA1029	\$682.06		5	
										6

See Our Website For Current Pricing & Real-Time Stock Availability!

Waveguides

Waveguide to Coax Adapters



See Our Website For Current Pricing & Real-Time Stock Availability!

WG Type	RF Freq. (GHz.)	IL (dB)	Max VSWR	Flange Type	Connector	ECCN	Model No	1 Pc. Price	See Web for Volume Pricing	ROW	
WR-75	10-15	0.3	1.25:1	Square Cover	SMA Female	EAR99	PEWCA1024	\$491.82	See Web for Volume Pricing	7	
	9.84-15	0.2		UBR120	N Female	EAR99	PEWCA1095	Call		8	
					SMA Female	EAR99	PEWCA1096	Call		9	
	10-15			1.3:1	Square Cover	N Female	EAR99	PEWCA1074		\$819.77	10
						SMA Female	EAR99	PEWCA1073		\$749.00	11
						N Female	EAR99	PE9874		\$466.93	12
				1.4:1	Square Type	SMA Female	EAR99	PE9819		\$368.09	13
						N Female	EAR99	PE9867		\$679.08	14
						SMA Female	EAR99	PE9847		\$626.60	15
	WR-90	8.2-12.4	0.25	1.25:1	CMR-90	N Female	EAR99	PEWCA1033		\$767.96	16
						SMA Female	EAR99	PEWCA1032		\$767.96	17
						N Female	EAR99	PEWCA1009		\$562.97	18
						N Female	EAR99	PEWCA1036		\$692.89	19
						N Male	EAR99	PEWCA1035		\$649.00	20
						SMA Female	EAR99	PEWCA1007		\$523.27	21
0.3			Square Cover UG-135/U		SMA Female	EAR99	PEWCA1034	\$639.09	22		
					N Female	EAR99	PE9868	\$769.00	23		
					N Female	EAR99	PEWCA1031	\$776.04	24		
					Square Cover UG-39/U	N Female	EAR99	PEWCA1008	\$650.21	25	
					SMA Female	EAR99	PEWCA1025	\$498.01	26		
					SMA Female	EAR99	PEWCA1075	\$759.00	27		
0.2		Square Cover UG-135/U	SMA Male	EAR99	PEWCA1030	\$664.66	28				
			SMA Female	EAR99	PEWCA1006	\$627.93	29				
			Square Cover UG-39/U	N Female	EAR99	PEWCA1092	Call	30			
			UBR100	SMA Female	EAR99	PEWCA1093	Call	31			
			UDR100	N Female	EAR99	PE9883	\$368.51	32			
			CPR-90G	N Female	EAR99	PE9873	\$457.04	33			
8.2-12.4		0.3	1.3:1	1.4:1	Square Type	N Female	EAR99	PE9801	\$379.39	34	
						N Male	EAR99	PE9889	\$442.08	35	
						SMA Female	EAR99	PE9804	\$359.58	36	
						SMA Male	EAR99	PE9810	\$457.47	37	
						SMA Female	EAR99	PE9848	\$562.88	38	
						SMA Female	EAR99	PE9869	\$441.19	39	
WR-102	7-11	1.25:1	1.25:1	Square Cover	N Female	EAR99	PEWCA1038	\$780.00	40		
					N Male	EAR99	PEWCA1039	\$780.00	41		
					SMA Female	EAR99	PE9805	\$616.47	42		
					SMA Female	EAR99	PEWCA1037	\$726.67	43		
					Square Cover UG-1493/U	SMA Male	EAR99	PE9811	\$325.83	44	
					SMA Male	EAR99	PE9802	\$490.14	45		
	7-10	1.3:1	1.3:1	1.4:1	Square Type	N Male	EAR99	PE9890	\$449.00	46	
						SMA Female	EAR99	PE9871	\$435.56	47	
						N Female	EAR99	PEWCA1043	\$685.67	48	
						SMA Female	EAR99	PEWCA1042	\$659.93	49	
						N Female	EAR99	PEWCA1013	\$548.80	50	
						N Female	EAR99	PEWCA1045	\$700.12	51	
WR-112	7.05-10	1.25:1	1.25:1	CPR-112G	SMA Female	EAR99	PEWCA1011	\$641.88	52		
					SMA Female	EAR99	PEWCA1044	\$656.46	53		
					Square Cover UG-138/U	N Female	EAR99	PEWCA1041	\$646.67	54	
					Square Cover UG-51/U	N Female	EAR99	PEWCA1012	\$658.56	55	
					Square Cover UG-138/U	SMA Female	EAR99	PEWCA1040	\$699.00	56	
					Square Cover UG-51/U	SMA Female	EAR99	PEWCA1010	\$666.91	57	
	6.57-9.99	0.2	1.3:1	1.4:1	UBR84	N Female	EAR99	PEWCA1089	Call	58	
						SMA Female	EAR99	PEWCA1090	Call	59	
						CPR-112G	N Female	EAR99	PE9837	\$591.88	60
						N Female	EAR99	PE9820	\$385.50	61	
						N Female	EAR99	PE9870	\$548.97	62	
						SMA Female	EAR99	PE9884	\$347.06	63	
WR-137	5.85-8.2	1.25:1	1.4:1	CMR-137	SMA Female	EAR99	PE9865	\$595.38	64		
					N Female	EAR99	PEWCA1049	\$677.30	65		
					SMA Female	EAR99	PEWCA1048	\$677.30	66		
					N Female	EAR99	PEWCA1017	\$559.22	67		
					N Female	EAR99	PEWCA1051	\$707.32	68		
					SMA Female	EAR99	PEWCA1015	\$577.40	69		
	5.38-8.17	0.2	1.25:1	1.4:1	CPR-137G	SMA Female	EAR99	PEWCA1050	\$677.30	70	
						N Female	EAR99	PEWCA1087	Call	71	
						Round Cover UG-344/U	N Female	EAR99	PEWCA1016	\$697.23	72
						Round Cover UG-441/U	N Female	EAR99	PEWCA1047	\$707.32	73
						Round Cover UG-344/U	SMA Female	EAR99	PEWCA1014	\$577.40	74
						Round Cover UG-441/U	SMA Female	EAR99	PEWCA1046	\$677.30	75
5.38-8.17	0.2			UDR70	N Female	EAR99	PEWCA1086	Call	76		

Waveguides

Waveguide to Coax Adapters



WG Type	RF Freq. (GHz.)	IL (dB)	Max VSWR	Flange Type	Connector	ECCN	Model No	1 Pc. Price	See Web for Volume Pricing	ROW
WR-137	9.84-1.5	0.2	1.25:1	UDR70	SMA Female	EAR99	PEWCA1088	Call	See Web for Volume Pricing	77
	5.85-8.2	0.4	1.3:1	CMR-137	N Female	EAR99	PE9876	\$215.32		78
				CPR-137G	SMA Female	EAR99	PE9830	\$531.11		79
WR-159	4.9-7.05	0.2	1.25:1	CMR-159	N Female	EAR99	PE9838	\$349.97		80
				CPR-159G	N Female	EAR99	PEWCA1053	\$623.40		81
				UDR58	SMA Female	EAR99	PEWCA1052	\$671.89		82
	5.38-8.17	0.2	1.3:1	CMR-159	N Female	EAR99	PEWCA1055	\$623.40		83
				CPR-159G	SMA Female	EAR99	PEWCA1054	\$646.67		84
				UDR70	SMA Female	EAR99	PEWCA1085	Call		85
WR-187	3.95-5.85	0.2	1.25:1	CMR-187	N Female	EAR99	PE9821	\$717.38		86
				CPR-187G	SMA Female	EAR99	PE9831	\$673.53		87
	3.94-5.99	0.2	1.3:1	CMR-187	N Female	EAR99	PE9839	\$756.82		88
				CPR-187G	N Female	EAR99	PEWCA1058	\$538.38		89
	3.95-5.85	0.2	1.25:1	Round Cover UG-407/U	SMA Female	EAR99	PEWCA1057	\$620.71		90
				UDR48	N Female	EAR99	PEWCA1059	\$538.38		91
				UDR48	N Female	EAR99	PEWCA1084	Call		92
WR-229	3.95-5.85	0.2	1.3:1	CMR-187	N Female	EAR99	PEWCA1056	\$656.81		93
				CPR-187G	N Female	EAR99	PEWCA1083	Call		94
				CMR-229	N Female	EAR99	PE9822	\$483.63		95
	3.3-4.9	0.2	1.25:1	CPR-187G	SMA Female	EAR99	PE9832	\$816.17		96
				CMR-229	N Female	EAR99	PE9840	\$847.45	97	
				CPR-229G	N Female	EAR99	PEWCA1060	\$640.72	98	
WR-284	2.6-3.95	0.2	1.25:1	CPR-229G	N Female	EAR99	PEWCA1062	\$640.72	99	
				CMR-229	N Female	EAR99	PEWCA1061	\$653.33	1	
				UDR32	SMA Female	EAR99	PE9823	\$619.87	2	
	2.6-3.95	0.2	1.3:1	CMR-284	N Female	EAR99	PE9833	\$661.78	3	
				CPR-284G	N Female	EAR99	PE9877	\$901.09	4	
				UDR32	N Female	EAR99	PEWCA1064	\$720.38	5	
				UDR32	SMA Female	EAR99	PE9834	\$1,302.50	6	
2.2-3.3	0.2	1.25:1	Round Cover UG-584/U	N Female	EAR99	PEWCA1065	\$773.33	7		
			UDR32	N Female	EAR99	PEWCA1063	\$958.10	8		
			UDR32	N Female	EAR99	PEWCA1081	Call	9		
WR-340	2.2-3.3	0.2	1.3:1	UDR32	SMA Female	EAR99	PEWCA1082	Call	10	
				CMR-284	N Female	EAR99	PE9824	\$808.48	11	
				CPR-284G	N Female	EAR99	PE9842	\$529.00	12	
				CPR-340F	N Female	EAR99	PEWCA1066	\$1,299.00	13	
WR-430	1.7-2.6	0.2	1.25:1	CPR-340G	N Female	EAR99	PEWCA1067	\$1,299.00	14	
				CPR-430F	N Female	EAR99	PEWCA1068	\$1,453.56	15	
	1.72-2.61	0.3	1.3:1	CPR-430G	N Female	EAR99	PEWCA1069	\$1,499.00	16	
				UDR22	N Female	EAR99	PEWCA1079	Call	17	
	1.7-2.6	0.3	1.3:1	UDR22	SMA Female	EAR99	PEWCA1080	Call	18	
				CPR-430F	N Female	EAR99	PE9872	\$1,299.79	19	
CPR-430G				SMA Female	EAR99	PE9835	\$1,399.00	20		
				CPR-430G	N Female	EAR99	PE9843	\$1,484.61	21	

Corner Reflectors



Description	Model No	1	2-4	5-9	10+	ROW
1.4 inch Edge Length, Trihedral Corner Reflector, 1/4-20 Threaded Hole Mount, Aluminum Body, Gold Chem Film Finish	PEWRL0000	\$875.00	\$844.38	\$813.75	\$787.50	22
1.8 inch Edge Length, Trihedral Corner Reflector, 1/4-20 Threaded Hole Mount, Aluminum Body, Gold Chem Film Finish	PEWRL0001	\$962.50	\$928.81	\$895.13	\$866.25	23
2.4 inch Edge Length, Trihedral Corner Reflector, 1/4-20 Threaded Hole Mount, Aluminum Body, Gold Chem Film Finish	PEWRL0002	\$1,050.00	\$1,013.25	\$976.50	\$945.00	24
3.2 inch Edge Length, Trihedral Corner Reflector, 1/4-20 Threaded Hole Mount, Aluminum Body, Gold Chem Film Finish	PEWRL0003	\$1,450.00	\$1,399.25	\$1,348.50	\$1,305.00	25
4.3 inch Edge Length, Trihedral Corner Reflector, 1/4-20 Threaded Hole Mount, Aluminum Body, Gold Chem Film Finish	PEWRL0004	\$1,450.00	\$1,399.25	\$1,348.50	\$1,305.00	26
6 inch Edge Length, Trihedral Corner Reflector, 1/4-20 Threaded Hole Mount, Aluminum Body, Gold Chem Film Finish	PEWRL0005	\$1,725.00	\$1,664.63	\$1,604.25	\$1,552.50	27

See Our Website For Current Pricing & Real-Time Stock Availability!

Waveguides

Corner Reflectors



Description	Model No	1	2-4	5-9	10+	ROW
8 inch Edge Length, Trihedral Corner Reflector, 1/4-20 Threaded Hole Mount, Aluminum Body, Gold Chem Film Finish	PEWRL0006	\$2,050.00	\$1,978.25	\$1,906.50	\$1,845.00	28
8.5 inch Edge Length, Trihedral Corner Reflector, 1/4-20 Threaded Hole Mount, Aluminum Body, Gold Chem Film Finish	PEWRL0007	\$2,350.00	\$2,267.75	\$2,185.50	\$2,115.00	29
8.9 inch Edge Length, Trihedral Corner Reflector, 1/4-20 Threaded Hole Mount, Aluminum Body, Gold Chem Film Finish	PEWRL0008	\$2,625.00	\$2,533.13	\$2,441.25	\$2,362.50	30
10 inch Edge Length, Trihedral Corner Reflector, 1/4-20 Threaded Hole Mount, Aluminum Body, Gold Chem Film Finish	PEWRL0009	\$3,125.00	\$3,015.63	\$2,906.25	\$2,812.50	31
13 inch Edge Length, Trihedral Corner Reflector, 1/4-20 Threaded Hole Mount, Aluminum Body, Gold Chem Film Finish	PEWRL0010	\$3,625.00	\$3,498.13	\$3,371.25	\$3,262.50	32
13.5 inch Edge Length, Trihedral Corner Reflector, 1/4-20 Threaded Hole Mount, Aluminum Body, Gold Chem Film Finish	PEWRL0011	\$4,125.00	\$3,980.63	\$3,836.25	\$3,712.50	33
16 inch Edge Length, Trihedral Corner Reflector, 1/4-20 Threaded Hole Mount, Aluminum Body, Gold Chem Film Finish	PEWRL0012	\$6,000.00	\$5,790.00	\$5,580.00	\$5,400.00	34
24 inch Edge Length, Trihedral Corner Reflector, 1/4-20 Threaded Hole Mount, Aluminum Body, Gold Chem Film Finish	PEWRL0013	\$8,250.00	\$7,961.25	\$7,672.50	\$7,425.00	35

WAVEGUIDE BANDPASS FILTERS



Waveguide Type	RF Frequency (GHz.)	Max VSWR	Flange Type	ECCN	Model No	1-9	10-24	25-49	50+	ROW
WR-28	30 - 31	1.4:1	Square Cover	EAR99	PE-W28F001	\$390.41	\$370.89	\$351.37	\$335.75	36
	38 - 40	1.5:1		EAR99	PE-W28F002	\$378.92	\$359.97	\$341.03	\$325.87	37
WR-42	20.2 - 21.2	1.5:1		EAR99	PE-W42F001	\$382.46	\$363.34	\$344.21	\$328.92	38
	24.25 - 24.45	1.8:1		EAR99	PE-W42F002	\$351.87	\$337.80	\$327.24	\$320.20	39
		1.5:1		EAR99	PE-W42F004	\$368.10	\$349.70	\$331.29	\$316.57	40
	25.05 - 25.25	1.5:1		EAR99	PE-W42F003	Call	Call	Call	Call	41

WAVEGUIDE BENDS



Waveguide Type	RF Frequency (GHz.)	Insertion Loss (dB)	Bend Plane	Flange Type	ECCN	Model No	1 Pc. Price	See Web for Volume Pricing	ROW	
WR-5	140 - 220		E-Bend	Round Cover UG-383/U-Mod	EAR99	PEW5B0000	\$529.00	See Web for Volume Pricing	42	
			H-Bend		EAR99	PEW5B0001	\$529.00		43	
WR-6	110 - 170	0.35	E-Bend		EAR99	PEW6B0000	\$499.00		44	
			H-Bend		EAR99	PEW6B0001	\$499.00		45	
WR-8	90 - 140	0.3	E-Bend		EAR99	PEW8B0000	\$499.00		46	
			H-Bend		EAR99	PEW8B0001	\$499.00		47	
WR-10	75 - 110	0.21	E-Bend		Round Cover UG-387/U-Mod	EAR99	PE-W10B001		\$486.54	48
			H-Bend		EAR99	PE-W10B002	\$486.54		49	
WR-12	60 - 90		E-Bend		Round Cover UG-387/U	EAR99	PE-W12B001		\$409.92	50
			H-Bend		EAR99	PE-W12B002	\$398.43		51	
WR-15	50 - 75	0.17	E-Bend	Round Cover UG-385/U	EAR99	PE-W15B001	\$540.24	52		
			H-Bend	EAR99	PE-W15B002	\$540.24	53			
WR-19	40 - 60	0.18	E-Bend	Round Cover UG-383/U-Mod	EAR99	PE-W19B001	\$389.08	54		
			H-Bend	EAR99	PE-W19B002	\$389.08	55			
WR-22	33 - 50	0.25	E-Bend	Round Cover UG-383/U	EAR99	PEW22B100	\$374.50	56		
		0.16			EAR99	PEW22B101	\$374.50	57		
WR-28	26.5 - 40	0.28	H-Bend	Square Cover UG-599/U	EAR99	PE-W22B001	\$389.08	58		
		0.3			EAR99	PE-W28B001	\$416.33	59		
WR-42	18 - 26.5	0.15	H-Bend	Square Cover UG-595/U	EAR99	PE-W28B002	\$518.46	60		
					EAR99	PE-W28B003	\$430.00	61		
WR-51	15 - 22	0.09	E-Bend	UBR180	EAR99	PEW42B100	\$400.70	62		
						PE-W51B001	\$378.92	63		

See Our Website For Current Pricing & Real-Time Stock Availability!

Waveguides

WAVEGUIDE BENDS



Waveguide Type	RF Frequency (GHz.)	Insertion Loss (dB)	Bend Plane	Flange Type	ECCN	Model No	1 Pc. Price	See Web for Volume Pricing			ROW	
WR-62	12.4 - 18	0.15	E-Bend	Square Cover UG-419/U	EAR99	PE-W62B001	\$421.36				64	
			H-Bend		EAR99	PE-W62B002	\$421.36				65	
			E-Bend		EAR99	PE-W62B003	\$378.92				66	
WR-75	10 - 15	0.09	H-Bend	UBR120	EAR99	PE-W62B004	\$405.45				67	
			E-Bend		EAR99	PE-W75B001	\$427.79				68	
			H-Bend		EAR99	PE-W75B002	\$461.55				69	
WR-90	8.2 - 12.4	0.15	E-Bend	Square Cover UG-39/U	EAR99	PE-W90B001	\$392.11				70	
			H-Bend		EAR99	PE-W90B002	\$400.89				71	
			H-Bend		EAR99	PE-W90B003A	\$399.00				72	
WR-112	7.05 - 10	0.15	E-Bend	Square Cover UG-51/U	EAR99	PE-W112B001	\$569.30				73	
			H-Bend		EAR99	PE-W112B002	\$490.05				74	
			E-Bend		EAR99	PE-W137B001	\$416.80				75	
WR-137	5.85 - 8.2	0.15	H-Bend	Round Cover UG-344/U	EAR99	PE-W137B002	\$433.06				76	
			H-Bend		EAR99	PE-W137B003A	Call				77	
			E-Bend									78
			H-Bend		EAR99	PE-W137B004	\$507.15					

WAVEGUIDE BULKHEAD ADAPTERS



Frequency Range (GHz.)	Waveguide Size	Flange 1	Flange 2	Model No	1 Pc. Price	See Web for Volume Pricing			ROW
75.0 - 110.0	WR-10	Round Cover UG-387/U-Mod	Round Cover UG-387/U-Mod	PEWAD5000	\$1,029.00	See Web for Volume Pricing			79
60.0 - 90.0	WR-12	Round Cover UG-387/U	Round Cover UG-387/U	PEWAD5001	\$930.85				80
50.0 - 75.0	WR-15	Round Cover UG-385/U	Round Cover UG-385/U	PEWAD5002	\$930.85				81
40.0 - 60.0	WR-19	Round Cover UG-383/U-Mod	Round Cover UG-383/U-Mod	PEWAD5003	\$930.85				82
33.0 - 50.0	WR-22	Round Cover UG-383/U	Round Cover UG-383/U	PEWAD5007	\$850.98				83
			Round Cover UG-383/U	PEWAD5004	\$930.85				84
26.5 - 40.0	WR-28	Square Cover UG-599/U	Square Cover UG-599/U	PEWAD5008	\$743.29				85
			Square Cover UG-599/U	PEWAD5005	\$1,042.56				86
22.0 - 33.0	WR-34	Square Cover UG-1530/U	Square Cover UG-1530/U	PEWAD5009	\$757.20				87
18.0 - 26.5	WR-42	Square Cover UG-595/U	Square Cover UG-595/U	PEWAD5010	\$778.04				88
			Square Cover UG-595/U	PEWAD5006	\$1,042.56				89
15.0 - 22.0	WR-51	Square Cover	Square Cover	PEWAD5011	\$791.92				90
12.4 - 18.0	WR-62	Square Cover UG-1665/U	Square Cover UG-1665/U	PEWAD5012	\$826.65				91
10.0 - 15.0	WR-75	Square Cover	Square Cover	PEWAD5013	\$850.98				92
8.2 - 12.4	WR-90	Square Cover UG-39/U	Square Cover UG-39/U	PEWAD5014	\$882.24				93
		CPR-90G	CPR-90G	PEWAD5015	\$882.24				94
7.05 - 10.0	WR-112	Square Cover UG-51/U	Square Cover UG-51/U	PEWAD5016	\$930.85				95
		CPR-112G	CPR-112G	PEWAD5017	\$930.85				96
5.85 - 8.2	WR-137	Square Cover UG-344/U	Square Cover UG-344/U	PEWAD5018	\$979.48				97
		CPR-137G	CPR-137G	PEWAD5019	\$979.48	98			

WAVEGUIDE CONVERTER MIXERS

Down Converter



RF/LO Frequency (GHz.)	IF Frequency (GHz.)	LO Power (dBm)	Typ Conv. Loss (dB)	RF & LO Waveguide Type	IF Connector	ECCN	Model No	1	2-4	5-9	10+	ROW
26.5 - 40	DC - 18	15	6	WR-28 UG-599/U	SMA Female	EAR99	PE12D1005	\$3,686.78	\$3,539.31	\$3,391.84	\$3,244.37	99
33 - 50	DC - 18	15	7	WR-22 UG-383/U	SMA Female	EAR99	PE12D1004	\$4,185.35	\$4,017.94	\$3,850.52	\$3,683.11	1
50 - 75	DC - 18	15	8	WR-15 UG-385/U	SMA Female	EAR99	PE12D1002	\$4,522.88	\$4,341.96	\$4,161.05	\$3,980.13	2

Down Converter



RF/LO Frequency (GHz.)	IF Frequency (GHz.)	LO Power (dBm)	Typ Conv. Loss (dB)	RF & LO Waveguide Type	IF Connector	ECCN	Model No	1	2-4	5-9	10+	ROW
60 - 90	DC - 18	15	9	WR-12 UG-387/U	SMA Female	EAR99	PE12D1001	\$4,394.24	\$4,218.47	\$4,042.70	\$3,866.93	3
75 - 110	DC - 18	15	9	WR-10 UG-387/U-Mod	SMA Female	EAR99	PE12D1000	\$6,178.38	\$5,931.24	\$5,684.11	\$5,436.97	4

Up Converter



RF/LO Frequency (GHz.)	IF Frequency (GHz.)	LO Power (dBm)	Typ Conv. Loss (dB)	RF & LO Waveguide Type	IF Connector	ECCN	Model No	1	2-4	5-9	10+	ROW
26.5 - 40	DC - 18	15	6	WR-28 UG-599/U	SMA Female	EAR99	PE13U1005	\$3,932.52	\$3,775.22	\$3,617.92	\$3,460.62	5
33 - 50	DC - 18	15	7	WR-22 UG-383/U	SMA Female	EAR99	PE13U1004	\$4,759.15	\$4,568.78	\$4,378.42	\$4,188.05	6
40 - 60	DC - 18	15	7	WR-19 UG-383/U	SMA Female	EAR99	PE13U1003	\$4,443.82	\$4,266.07	\$4,088.31	\$3,910.56	7
50 - 75	DC - 18	15	8	WR-15 UG-385/U	SMA Female	EAR99	PE13U1002	\$5,062.93	\$4,860.41	\$4,657.90	\$4,455.38	8
60 - 90	DC - 18	15	9	WR-12 UG-387/U	SMA Female	EAR99	PE13U1001	\$5,248.57	\$5,038.63	\$4,828.68	\$4,618.74	9
75 - 110	DC - 18	15	9	WR-10 UG-387/U	SMA Female	EAR99	PE13U1000	\$5,285.82	\$5,074.39	\$4,862.95	\$4,651.52	10

WAVEGUIDE COUPLERS

Broadwall



WG Type	RF Freq. (GHz.)	IL (dB)	Max VSWR	Coupling (dB)	Directivity (dB)	Flange Type	ECCN	Model No	1	2-4	5-9	10+	ROW
WR-10	75 - 110	1.1	1.2:1	20	30	Round Cover UG-387/U-Mod	EAR99	PE-W10CP001-20	\$2,344.50	\$2,250.72	\$2,156.94	\$2,063.16	11
				20	30		EAR99	PE-W10CP003-20	\$2,564.15	\$2,461.58	\$2,359.02	\$2,256.45	12
		1.4		10	30		EAR99	PE-W10CP001-10	\$2,344.50	\$2,250.72	\$2,156.94	\$2,063.16	13
				10	30		EAR99	PE-W10CP003-10	\$2,564.15	\$2,461.58	\$2,359.02	\$2,256.45	14
				20	40		EAR99	PEW10CP010-20	\$2,467.90	\$2,369.18	\$2,270.47	\$2,171.75	15
WR-12	60 - 90	1	1.2:1	20	30	Round Cover UG-387/U	EAR99	PE-W12CP001-20	\$2,458.32	\$2,359.99	\$2,261.65	\$2,163.32	16
				20	30		EAR99	PE-W12CP003-20	\$2,488.18	\$2,388.65	\$2,289.13	\$2,189.60	17
		1.4		10	30		EAR99	PE-W12CP001-10	\$2,458.32	\$2,359.99	\$2,261.65	\$2,163.32	18
				10	30		EAR99	PE-W12CP003-10	\$2,587.70	\$2,484.19	\$2,380.68	\$2,277.18	19
				20	30		EAR99	PE-W15CP001-20	\$2,431.19	\$2,333.94	\$2,236.69	\$2,139.45	20
WR-15	50 - 75	1	1.2:1	20	30	Round Cover UG-385/U	EAR99	PE-W15CP003-20	Call	Call	Call	Call	21
				10	30		EAR99	PE-W15CP001-10	\$2,317.23	\$2,224.54	\$2,131.85	\$2,039.16	22
		1.4		10	30		EAR99	PE-W15CP003-10	\$2,317.23	\$2,224.54	\$2,131.85	\$2,039.16	23
				10	30		EAR99	PE-W19CP003-10	\$2,421.69	\$2,324.82	\$2,227.95	\$2,131.09	24
				20	30		EAR99	PE-W19CP003-20	\$2,374.21	\$2,279.24	\$2,184.27	\$2,089.30	25
WR-19	40 - 60	0.8	1.2:1	20	30	Round Cover UG-383/U	EAR99	PE-W19CP001-20	\$2,170.83	\$2,084.00	\$1,997.16	\$1,910.33	26
				20	30		EAR99	PE-W19CP001-10	\$2,170.83	\$2,084.00	\$1,997.16	\$1,910.33	27
		1		20	30		EAR99	PEW22CP010-20	\$2,230.50	\$2,141.28	\$2,052.06	\$1,962.84	28
				20	30		EAR99	PE-W22CP003-20	\$2,409.93	\$2,313.53	\$2,217.14	\$2,120.74	29
				10	30		EAR99	PE-W22CP001-10	\$2,317.23	\$2,224.54	\$2,131.85	\$2,039.16	30
WR-28	26.5 - 40	0.6	1.1:1	20	30	Square Cover UG-599/U	EAR99	PEW28CP010-20	\$2,241.26	\$2,151.61	\$2,061.96	\$1,972.31	31
				20	30		EAR99	PE-W28CP003-20	\$2,286.09	\$2,194.65	\$2,103.20	\$2,011.76	32
		1		10	30		EAR99	PE-W28CP002-10	\$2,241.26	\$2,151.61	\$2,061.96	\$1,972.31	33
				10	30		EAR99	PE-W28CP003-10	\$2,330.91	\$2,237.67	\$2,144.44	\$2,051.20	34
				Call	Call		EAR99	PE-W28CP004-10	Call	Call	Call	Call	35
WR-34	22 - 33	0.15	1.05:1	20	35	Square Cover UG-1530/U	EAR99	PEWCP1006	\$1,508.49	\$1,448.15	\$1,387.81	\$1,327.47	36
				30	35		EAR99	PEWCP1007	\$1,508.49	\$1,448.15	\$1,387.81	\$1,327.47	37
		10		35	EAR99		PEWCP1005	\$1,451.87	\$1,393.80	\$1,335.72	\$1,277.65	38	

Broadwall



WG Type	RF Freq. (GHz.)	IL (dB)	Max VSWR	Coupling (dB)	Directivity (dB)	Flange Type	ECCN	Model No	1	2-4	5-9	10+	ROW		
WR-42	18 - 26.5	0.6	1.2:1	20	30	Square Cover UG-595/U	EAR99	PE-W42CP002-20	\$2,241.26	\$2,151.61	\$2,061.96	\$1,972.31	39		
				20	30		EAR99	PE-W42CP004-20	\$2,330.91	\$2,237.67	\$2,144.44	\$2,051.20	40		
		1		10	30	EAR99	PE-W42CP002-10	\$2,157.13	\$2,070.84	\$1,984.56	\$1,898.27	41			
				10	30	EAR99	PE-W42CP004-10	\$2,330.91	Call	Call	Call	42			
WR-51	15 - 22	0.15	1.05:1	10	35	Square Cover	EAR99	PEWCP1008	\$1,479.62	\$1,420.44	\$1,361.25	\$1,302.07	43		
WR-62	12.4 - 18			20	35		EAR99	PEWCP1009	\$1,479.62	\$1,420.44	\$1,361.25	\$1,302.07	44		
				30	35	EAR99	PEWCP1010	\$1,538.80	\$1,477.25	\$1,415.70	\$1,354.14	45			
				10	40	Square Cover UG-419/U	EAR99	PEWCP1011	\$1,320.82	\$1,267.99	\$1,215.15	\$1,162.32	46		
20	40			EAR99	PEWCP1012		\$1,373.65	\$1,318.70	\$1,263.76	\$1,208.81	47				
WR-75	10 - 15			30	40	Square Cover	EAR99	PEWCP1013	\$1,373.65	\$1,318.70	\$1,263.76	\$1,208.81	48		
				10	40		EAR99	PEWCP1014	\$1,292.08	\$1,240.40	\$1,188.71	\$1,137.03	49		
				20	40	EAR99	PEWCP1015	\$1,292.08	\$1,240.40	\$1,188.71	\$1,137.03	50			
WR-90	8.2 - 12.4			0.15	1.05:1	30	40	Square Cover UG-39/U	EAR99	PEWCP1016	\$1,396.18	\$1,340.33	\$1,284.49	\$1,228.64	51
						10	40		EAR99	PEWCP1017	\$1,546.31	\$1,484.46	\$1,422.61	\$1,360.75	52
						10	40	CPR-90G	EAR99	PEWCP1020	\$1,437.96	\$1,380.44	\$1,322.92	\$1,265.40	53
						20	40	Square Cover UG-39/U	EAR99	PEWCP1018	\$1,486.84	\$1,427.37	\$1,367.89	\$1,308.42	54
		20	40			CPR-90G	EAR99	PEWCP1021	\$1,437.96	\$1,380.44	\$1,322.92	\$1,265.40	55		
		30	40			Square Cover UG-39/U	EAR99	PEWCP1019	\$1,546.31	\$1,484.46	\$1,422.61	\$1,360.75	56		
		30	40			CPR-90G	EAR99	PEWCP1022	\$1,437.96	\$1,380.44	\$1,322.92	\$1,265.40	57		
		WR-112	7.05 - 10			0.15	1.05:1	10	40	Square Cover UG-51/U	EAR99	PEWCP1023A	\$1,395.97	\$1,340.13	\$1,284.29
10	40			CPR-112G	EAR99			PEWCP1026	\$1,368.51	\$1,313.77	\$1,259.03	\$1,204.29	59		
20	40			Square Cover UG-51/U	EAR99			PEWCP1024	\$1,319.88	\$1,267.08	\$1,214.29	\$1,161.49	60		
20	40			CPR-112G	EAR99			PEWCP1027	\$1,368.51	\$1,313.77	\$1,259.03	\$1,204.29	61		
30	40			Square Cover UG-51/U	EAR99			PEWCP1025	\$1,371.36	\$1,316.51	\$1,261.65	\$1,206.80	62		
30	40			CPR-112G	EAR99			PEWCP1028	\$1,368.51	\$1,313.77	\$1,259.03	\$1,204.29	63		
WR-137	5.85 - 8.2	0.15	1.05:1	10	40	Round Cover UG-344/U	EAR99	PEWCP1029	\$1,396.28	\$1,340.43	\$1,284.58	\$1,228.73	64		
				10	40	CPR-137G	EAR99	PEWCP1032	\$1,444.92	\$1,387.12	\$1,329.33	\$1,271.53	65		
				20	40	Round Cover UG-344/U	EAR99	PEWCP1030	\$1,396.28	\$1,340.43	\$1,284.58	\$1,228.73	66		
				20	40	CPR-137G	EAR99	PEWCP1033	\$1,444.92	\$1,387.12	\$1,329.33	\$1,271.53	67		
				30	40	Round Cover UG-344/U	EAR99	PEWCP1031	\$1,396.28	\$1,340.43	\$1,284.58	\$1,228.73	68		
				30	40	CPR-137G	EAR99	PEWCP1034	\$1,501.27	\$1,441.22	\$1,381.17	\$1,321.12	69		

Crossguide*



WG Type	RF Freq. (GHz.)	IL (dB)	Max VSWR	Coupling (dB)	Directivity (dB)	Flange Type	ECCN	Model No	1 Pc. Price	See Web for Volume Pricing	ROW		
WR-34	22 - 33	0.1	1.05:1	20	20	Square Cover UG-1530/U	EAR99	PEWCP1035	\$977.51	See Web for Volume Pricing	70		
				30	20		EAR99	PEWCP1036	\$977.51		71		
				40	25	EAR99	PEWCP1037	\$977.51	72				
				50	10	EAR99	PEWCP1038	\$977.51	73				
WR-42	18 - 26.5			0.1	1.05:1	20	30	Square Cover UG-595/U	EAR99		PEWCP1039	\$779.03	74
						30	20		EAR99		PEWCP1040	\$841.79	75
						40	20	EAR99	PEWCP1041		\$779.03	76	
WR-51	15 - 22			0.1	1.05:1	50	10	Square Cover	EAR99		PEWCP1042	\$841.79	77
						20	20		EAR99		PEWCP1043	\$1,203.26	78
						30	30	EAR99	PEWCP1044		\$1,203.26	79	
						40	30	EAR99	PEWCP1045		\$1,203.26	80	
WR-62	12.4 - 18			0.1	1.05:1	50	10	Square Cover UG-419/U	EAR99		PEWCP1046	\$1,203.26	81
		20	20			EAR99	PEWCP1047		\$809.41	82			
		30	10			EAR99	PEWCP1048	\$809.41	83				
WR-75	10 - 15	0.1	1.05:1	40	30	Square Cover	EAR99	PEWCP1049	\$779.03	84			
				50	10		EAR99	PEWCP1050	\$779.03	85			
				20	25	EAR99	PEWCP1051	\$814.56	86				
				30	25	EAR99	PEWCP1052A	\$796.35	87				
				40	15	EAR99	PEWCP1053	\$814.56	88				

*These WG crossguide couplers are available as assemblies with termination and/or with WG to Coax Adapters, see WG Coupler Assemblies or visit our website

Crossguide*



WG Type	RF Freq. (GHz.)	IL (dB)	Max VSWR	Coupling (dB)	Directivity (dB)	Flange Type	ECCN	Model No	1-4	5-9	10-24	25+	R O W
WR-75	10 - 15	0.1	1.05:1	50	10	Square Cover	EAR99	PEWCP1054	\$783.98	\$744.78	\$705.58	\$674.22	89
WR-90	8.2 - 12.4			20	20	Square Cover UG-39/U	EAR99	PEWCP1055	\$793.93	\$754.23	\$714.54	\$682.78	90
				20	25	CPR-90G	EAR99	PEWCP1059	\$818.71	\$777.77	\$736.84	\$704.09	91
				30	20	Square Cover UG-39/U	EAR99	PEWCP1056	\$764.13	\$725.92	\$687.72	\$657.15	92
				30	20	CPR-90G	EAR99	PEWCP1060	\$818.71	\$777.77	\$736.84	\$704.09	93
				40	10	Square Cover UG-39/U	EAR99	PEWCP1057	\$825.70	\$784.42	\$743.13	\$710.10	94
				40	10	CPR-90G	EAR99	PEWCP1061	\$818.71	\$777.77	\$736.84	\$704.09	95
				50	10	Square Cover UG-39/U	EAR99	PEWCP1058	\$825.70	\$784.42	\$743.13	\$710.10	96
				50	10	CPR-90G	EAR99	PEWCP1062	\$884.67	\$840.44	\$796.20	\$760.82	97
WR-112	7.05 - 10			20	45	Square Cover UG-51/U	EAR99	PEWCP1063	\$878.97	\$835.02	\$791.07	\$755.91	98
				20	25	CPR-112G	EAR99	PEWCP1067	\$888.18	\$843.77	\$799.36	\$763.83	99
				30	25	Square Cover UG-51/U	EAR99	PEWCP1064	\$913.25	\$867.59	\$821.93	\$785.40	1
				30	25	CPR-112G	EAR99	PEWCP1068	\$888.18	\$843.77	\$799.36	\$763.83	2
				40	20	Square Cover UG-51/U	EAR99	PEWCP1065	\$878.97	\$835.02	\$791.07	\$755.91	3
				40	20	CPR-112G	EAR99	PEWCP1069	\$888.18	\$843.77	\$799.36	\$763.83	4
				50	10	Square Cover UG-51/U	EAR99	PEWCP1066	\$949.79	\$902.30	\$854.81	\$816.82	5
				50	10	CPR-112G	EAR99	PEWCP1070	\$959.75	\$911.76	\$863.78	\$825.39	6
WR-137	5.85 - 8.2			20	25	Round Cover UG-344/U	EAR99	PEWCP1071	\$893.14	\$848.48	\$803.83	\$768.10	7
				20	20	CPR-137G	EAR99	PEWCP1075	\$853.46	\$810.79	\$768.11	\$733.98	8
				30	20	Round Cover UG-344/U	EAR99	PEWCP1072	\$893.14	\$848.48	\$803.83	\$768.10	9
		30	20	CPR-137G	EAR99	PEWCP1076	\$853.46	\$810.79	\$768.11	\$733.98	10		
		40	20	Round Cover UG-344/U	EAR99	PEWCP1073	\$893.14	\$848.48	\$803.83	\$768.10	11		
		40	20	CPR-137G	EAR99	PEWCP1077	\$853.46	\$810.79	\$768.11	\$733.98	12		
		50	10	Round Cover UG-344/U	EAR99	PEWCP1074	\$893.14	\$848.48	\$803.83	\$768.10	13		
		50	10	CPR-137G	EAR99	PEWCP1078	\$853.46	\$810.79	\$768.11	\$733.98	14		

Crossguide* with Termination



WG Type	RF Freq. (GHz.)	IL (dB)	Max VSWR	Coupling (dB)	Directivity (dB)	Flange Type	ECCN	Model No	1	2-4	5-9	10+	R O W
WR-34	22 - 33	0.1	1.05:1	20	20	Square Cover UG-1530/U	EAR99	PEWCT1000	\$1,541.48	\$1,479.82	\$1,418.16	\$1,356.50	15
				30	20		EAR99	PEWCT1001	\$1,541.48	\$1,479.82	\$1,418.16	\$1,356.50	16
				40	25		EAR99	PEWCT1002	\$1,601.60	\$1,537.54	\$1,473.47	\$1,409.41	17
				50	10		EAR99	PEWCT1003	\$1,541.48	\$1,479.82	\$1,418.16	\$1,356.50	18
WR-42	18 - 26.5			20	30	Square Cover UG-595/U	EAR99	PEWCT1004	\$1,312.24	\$1,259.75	\$1,207.26	\$1,154.77	19
				30	20		EAR99	PEWCT1005	\$1,312.24	\$1,259.75	\$1,207.26	\$1,154.77	20
				40	20		EAR99	PEWCT1006	\$1,312.24	\$1,259.75	\$1,207.26	\$1,154.77	21
				50	10		EAR99	PEWCT1007	\$1,312.24	\$1,259.75	\$1,207.26	\$1,154.77	22
WR-51	15 - 22			20	20	Square Cover	EAR99	PEWCT1008	\$1,748.84	\$1,678.89	\$1,608.93	\$1,538.98	23
				30	30		EAR99	PEWCT1009	\$1,748.84	\$1,678.89	\$1,608.93	\$1,538.98	24
				40	30		EAR99	PEWCT1010	\$1,748.84	\$1,678.89	\$1,608.93	\$1,538.98	25
				50	10		EAR99	PEWCT1011	\$1,748.84	\$1,678.89	\$1,608.93	\$1,538.98	26
WR-62	12.4 - 18			20	20	Square Cover UG-419/U	EAR99	PEWCT1012	\$1,298.34	\$1,246.41	\$1,194.47	\$1,142.54	27
				30	10		EAR99	PEWCT1013	\$1,348.98	\$1,295.02	\$1,241.06	\$1,187.10	28
				40	30		EAR99	PEWCT1014	\$1,298.34	\$1,246.41	\$1,194.47	\$1,142.54	29
				50	10		EAR99	PEWCT1015	\$1,298.34	\$1,246.41	\$1,194.47	\$1,142.54	30
WR-75	10 - 15			20	25	Square Cover	EAR99	PEWCT1016	\$1,357.63	\$1,303.32	\$1,249.02	\$1,194.71	31
				30	25		EAR99	PEWCT1017	\$1,306.67	\$1,254.40	\$1,202.14	\$1,149.87	32
				40	15		EAR99	PEWCT1018	\$1,306.67	\$1,254.40	\$1,202.14	\$1,149.87	33
				50	10		EAR99	PEWCT1019	\$1,357.63	\$1,303.32	\$1,249.02	\$1,194.71	34
WR-90	8.2 - 12.4	20	20	Square Cover UG-39/U	EAR99	PEWCT1020	\$1,276.81	\$1,225.74	\$1,174.67	\$1,123.59	35		
		20	25	CPR-90G	EAR99	PEWCT1024	\$1,340.72	\$1,287.09	\$1,233.46	\$1,179.83	36		

*These WG crossguide couplers are available as assemblies with termination and/or with WG to Coax Adapters, see WG Coupler Assemblies or visit our website

Crossguide* with Termination



WG Type	RF Freq. (GHz.)	IL (dB)	Max VSWR	Coupling (dB)	Directivity (dB)	Flange Type	ECCN	Model No	1	2-4	5-9	10+	ROW
WR-90	8.2 - 12.4	0.1	1.05:1	30	20	Square Cover UG-39/U	EAR99	PEWCT1021	\$1,276.81	\$1,225.74	\$1,174.67	\$1,123.59	37
				30	20	CPR-90G	EAR99	PEWCT1025	\$1,340.72	\$1,287.09	\$1,233.46	\$1,179.83	38
				40	10	Square Cover UG-39/U	EAR99	PEWCT1022	\$1,276.81	\$1,225.74	\$1,174.67	\$1,123.59	39
				40	10	CPR-90G	EAR99	PEWCT1026	\$1,340.72	\$1,287.09	\$1,233.46	\$1,179.83	40
				50	10	Square Cover UG-39/U	EAR99	PEWCT1023	\$1,276.81	\$1,225.74	\$1,174.67	\$1,123.59	41
				50	10	CPR-90G	EAR99	PEWCT1027	\$1,340.72	\$1,287.09	\$1,233.46	\$1,179.83	42
WR-112	7.05 - 10	0.1	1.05:1	20	45	Square Cover UG-51/U	EAR99	PEWCT1028	\$1,424.08	\$1,367.12	\$1,310.15	\$1,253.19	43
				20	25	CPR-112G	EAR99	PEWCT1032	\$1,440.05	\$1,382.45	\$1,324.85	\$1,267.24	44
				30	25	Square Cover UG-51/U	EAR99	PEWCT1029	\$1,481.43	\$1,422.17	\$1,362.92	\$1,303.66	45
				30	25	CPR-112G	EAR99	PEWCT1033	\$1,440.05	\$1,382.45	\$1,324.85	\$1,267.24	46
				40	20	Square Cover UG-51/U	EAR99	PEWCT1030	\$1,425.82	\$1,368.79	\$1,311.75	\$1,254.72	47
				40	20	CPR-112G	EAR99	PEWCT1034	\$1,440.05	\$1,382.45	\$1,324.85	\$1,267.24	48
				50	10	Square Cover UG-51/U	EAR99	PEWCT1031	\$1,425.82	\$1,368.79	\$1,311.75	\$1,254.72	49
				50	10	CPR-112G	EAR99	PEWCT1035	\$1,440.05	\$1,382.45	\$1,324.85	\$1,267.24	50
				20	25	Round Cover UG-344/U	EAR99	PEWCT1036	\$1,469.22	\$1,410.45	\$1,351.68	\$1,292.91	51
				20	20	CPR-137G	EAR99	PEWCT1040	\$1,433.80	\$1,376.45	\$1,319.10	\$1,261.74	52
WR-137	5.85 - 8.2	0.1	1.05:1	30	20	Round Cover UG-344/U	EAR99	PEWCT1037	\$1,469.22	\$1,410.45	\$1,351.68	\$1,292.91	53
				30	20	CPR-137G	EAR99	PEWCT1041	\$1,433.80	\$1,376.45	\$1,319.10	\$1,261.74	54
				40	20	Round Cover UG-344/U	EAR99	PEWCT1038	\$1,469.22	\$1,410.45	\$1,351.68	\$1,292.91	55
				40	20	CPR-137G	EAR99	PEWCT1042	\$1,433.80	\$1,376.45	\$1,319.10	\$1,261.74	56
				50	10	Round Cover UG-344/U	EAR99	PEWCT1039	\$1,469.22	\$1,410.45	\$1,351.68	\$1,292.91	57
				50	10	CPR-137G	EAR99	PEWCT1043	\$1,433.80	\$1,376.45	\$1,319.10	\$1,261.74	58

Crossguide* with Termination and WG to Coax Adapter



WG Type	RF Freq. (GHz.)	IL (dB)	Max VSWR	Coupling (dB)	Directivity (dB)	Flange Type	ECCN	Model No	1	2-4	5-9	10+	ROW
WR-34	22 - 33	0.1	1.05:1	20	20	Square Cover UG-1530/U	EAR99	PEWCT1044	\$2,151.50	\$2,065.44	\$1,979.38	\$1,893.32	59
				30	20		EAR99	PEWCT1045	\$2,151.50	\$2,065.44	\$1,979.38	\$1,893.32	60
				40	25		EAR99	PEWCT1046	\$2,151.50	\$2,065.44	\$1,979.38	\$1,893.32	61
				50	10		EAR99	PEWCT1047	\$2,151.50	\$2,065.44	\$1,979.38	\$1,893.32	62
WR-42	18 - 26.5	0.1	1.05:1	20	30	Square Cover UG-595/U	EAR99	PEWCT1048	\$1,946.07	\$1,868.23	\$1,790.38	\$1,712.54	63
				30	20		EAR99	PEWCT1049	\$1,946.07	\$1,868.23	\$1,790.38	\$1,712.54	64
				40	20		EAR99	PEWCT1050	\$1,946.07	\$1,868.23	\$1,790.38	\$1,712.54	65
				50	10		EAR99	PEWCT1051	\$1,946.07	\$1,868.23	\$1,790.38	\$1,712.54	66
WR-51	15 - 22	0.1	1.05:1	20	20	Square Cover	EAR99	PEWCT1052	\$2,300.85	\$2,208.82	\$2,116.78	\$2,024.75	67
				30	30		EAR99	PEWCT1053	\$2,300.85	\$2,208.82	\$2,116.78	\$2,024.75	68
				40	30		EAR99	PEWCT1054	\$2,300.85	\$2,208.82	\$2,116.78	\$2,024.75	69
				50	10		EAR99	PEWCT1055	\$2,300.85	\$2,208.82	\$2,116.78	\$2,024.75	70
WR-62	12.4 - 18	0.1	1.05:1	20	20	Square Cover UG-419/U	EAR99	PEWCT1056	\$1,793.23	\$1,721.50	\$1,649.77	\$1,578.04	71
				30	10		EAR99	PEWCT1057	\$1,937.69	\$1,860.18	\$1,782.67	\$1,705.17	72
				40	30		EAR99	PEWCT1058	\$1,793.23	\$1,721.50	\$1,649.77	\$1,578.04	73
				50	10		EAR99	PEWCT1059	\$1,793.23	\$1,721.50	\$1,649.77	\$1,578.04	74
WR-75	10 - 15	0.1	1.05:1	20	25	Square Cover	EAR99	PEWCT1060	\$1,808.63	\$1,736.28	\$1,663.94	\$1,591.59	75
				20	25		EAR99	PEWCT1064	\$1,857.24	\$1,782.95	\$1,708.66	\$1,634.37	76
				30	25		EAR99	PEWCT1061	\$1,879.17	\$1,804.00	\$1,728.84	\$1,653.67	77
				30	25		EAR99	PEWCT1065	\$1,857.24	\$1,782.95	\$1,708.66	\$1,634.37	78
				40	15		EAR99	PEWCT1062	\$1,954.34	\$1,876.17	\$1,797.99	\$1,719.82	79
				40	15		EAR99	PEWCT1066	\$2,006.86	\$1,926.59	\$1,846.31	\$1,766.04	80
				50	10		EAR99	PEWCT1063	\$1,916.76	\$1,840.09	\$1,763.42	\$1,686.75	81
				50	10		EAR99	PEWCT1067	\$1,857.24	\$1,782.95	\$1,708.66	\$1,634.37	82
WR-90	8.2 - 12.4	0.1	1.05:1	20	20	Square Cover UG-39/U	EAR99	PEWCT1068	\$1,865.74	\$1,791.11	\$1,716.48	\$1,641.85	83

*These WG crossguide couplers are available as assemblies with termination and/or with WG to Coax Adapters, see WG Coupler Assemblies or visit our website

Crossguide* with Termination and WG to Coax Adapter



WG Type	RF Freq. (GHz.)	IL (dB)	Max VSWR	Coupling (dB)	Directivity (dB)	Flange Type	ECCN	Model No	1	2-4	5-9	10+	R O W
WR-90	8.2 - 12.4			20	25	CPR-90G	EAR99	PEWCT1072	\$1,860.71	\$1,786.28	\$1,711.85	\$1,637.42	84
				20	20	Square Cover UG-39/U	EAR99	PEWCT1076	\$1,981.66	\$1,902.39	\$1,823.13	\$1,743.86	85
				20	25	CPR-90G	EAR99	PEWCT1080	\$1,898.92	\$1,822.96	\$1,747.01	\$1,671.05	86
				30	20	Square Cover UG-39/U	EAR99	PEWCT1069	\$1,865.74	\$1,791.11	\$1,716.48	\$1,641.85	87
				30	20	CPR-90G	EAR99	PEWCT1073	\$1,860.71	\$1,786.28	\$1,711.85	\$1,637.42	88
				30	20	Square Cover UG-39/U	EAR99	PEWCT1077	\$1,833.92	\$1,760.56	\$1,687.21	\$1,613.85	89
				30	20	CPR-90G	EAR99	PEWCT1081	\$1,898.92	\$1,822.96	\$1,747.01	\$1,671.05	90
				40	10	Square Cover UG-39/U	EAR99	PEWCT1070	\$1,795.71	\$1,723.88	\$1,652.05	\$1,580.22	91
				40	10	CPR-90G	EAR99	PEWCT1074	\$1,860.71	\$1,786.28	\$1,711.85	\$1,637.42	92
				40	10	Square Cover UG-39/U	EAR99	PEWCT1078	\$1,905.44	\$1,829.22	\$1,753.00	\$1,676.79	93
				40	10	CPR-90G	EAR99	PEWCT1082	\$1,898.92	\$1,822.96	\$1,747.01	\$1,671.05	94
				50	10	Square Cover UG-39/U	EAR99	PEWCT1071	\$1,795.71	\$1,723.88	\$1,652.05	\$1,580.22	95
				50	10	CPR-90G	EAR99	PEWCT1075	\$1,860.71	\$1,786.28	\$1,711.85	\$1,637.42	96
				50	10	Square Cover UG-39/U	EAR99	PEWCT1079	\$1,905.44	\$1,829.22	\$1,753.00	\$1,676.79	97
WR-112	7.05 - 10	0.1	1.05:1	20	45	Square Cover UG-51/U	EAR99	PEWCT1084	\$2,053.63	\$1,971.48	\$1,889.34	\$1,807.19	99
				20	25	CPR-112G	EAR99	PEWCT1088	\$1,992.70	\$1,912.99	\$1,833.28	\$1,753.58	1
				20	45	Square Cover UG-51/U	EAR99	PEWCT1092	\$1,990.44	\$1,910.82	\$1,831.20	\$1,751.59	2
				20	25	CPR-112G	EAR99	PEWCT1096	\$2,006.61	\$1,926.35	\$1,846.08	\$1,765.82	3
				30	25	Square Cover UG-51/U	EAR99	PEWCT1085	\$1,976.54	\$1,897.48	\$1,818.42	\$1,739.36	4
				30	25	CPR-112G	EAR99	PEWCT1089	\$1,992.70	\$1,912.99	\$1,833.28	\$1,753.58	5
				30	25	Square Cover UG-51/U	EAR99	PEWCT1093	\$1,990.44	\$1,910.82	\$1,831.20	\$1,751.59	6
				30	25	CPR-112G	EAR99	PEWCT1097	\$2,006.61	\$1,926.35	\$1,846.08	\$1,765.82	7
				40	20	Square Cover UG-51/U	EAR99	PEWCT1086	\$1,976.54	\$1,897.48	\$1,818.42	\$1,739.36	8
				40	20	CPR-112G	EAR99	PEWCT1090	\$1,992.70	\$1,912.99	\$1,833.28	\$1,753.58	9
				40	20	Square Cover UG-51/U	EAR99	PEWCT1094	\$1,990.44	\$1,910.82	\$1,831.20	\$1,751.59	10
				40	20	CPR-112G	EAR99	PEWCT1098	\$2,006.61	\$1,926.35	\$1,846.08	\$1,765.82	11
				50	10	Square Cover UG-51/U	EAR99	PEWCT1087	\$1,976.54	\$1,897.48	\$1,818.42	\$1,739.36	12
				50	10	CPR-112G	EAR99	PEWCT1091	\$1,992.70	\$1,912.99	\$1,833.28	\$1,753.58	13
50	10	Square Cover UG-51/U	EAR99	PEWCT1095	\$1,990.44	\$1,910.82	\$1,831.20	\$1,751.59	14				
WR-137	5.85 - 8.2			20	25	Round Cover UG-344/U	EAR99	PEWCT1100	\$2,042.81	\$1,961.10	\$1,879.39	\$1,797.67	16
				20	20	CPR-137G	EAR99	PEWCT1104	\$2,006.59	\$1,926.33	\$1,846.06	\$1,765.80	17
				20	25	Round Cover UG-344/U	EAR99	PEWCT1108	\$2,046.30	\$1,964.45	\$1,882.60	\$1,800.74	18
				20	20	CPR-137G	EAR99	PEWCT1112	\$2,010.08	\$1,929.68	\$1,849.27	\$1,768.87	19
				30	20	Round Cover UG-344/U	EAR99	PEWCT1101	\$2,042.81	\$1,961.10	\$1,879.39	\$1,797.67	20
				30	20	CPR-137G	EAR99	PEWCT1105	\$2,006.59	\$1,926.33	\$1,846.06	\$1,765.80	21
				30	20	Round Cover UG-344/U	EAR99	PEWCT1109	\$2,046.30	\$1,964.45	\$1,882.60	\$1,800.74	22
				30	20	CPR-137G	EAR99	PEWCT1113	\$2,010.08	\$1,929.68	\$1,849.27	\$1,768.87	23
				40	20	Round Cover UG-344/U	EAR99	PEWCT1102	\$2,042.81	\$1,961.10	\$1,879.39	\$1,797.67	24
				40	20	CPR-137G	EAR99	PEWCT1106	\$2,006.59	\$1,926.33	\$1,846.06	\$1,765.80	25
				40	20	Round Cover UG-344/U	EAR99	PEWCT1110	\$2,126.11	\$2,041.07	\$1,956.02	\$1,870.98	26
				40	20	CPR-137G	EAR99	PEWCT1114	\$2,172.02	\$2,085.14	\$1,998.26	\$1,911.38	27
				50	10	Round Cover UG-344/U	EAR99	PEWCT1103	\$2,042.81	\$1,961.10	\$1,879.39	\$1,797.67	28
				50	10	CPR-137G	EAR99	PEWCT1107	\$2,006.59	\$1,926.33	\$1,846.06	\$1,765.80	29
50	10	Round Cover UG-344/U	EAR99	PEWCT1111	\$2,046.30	\$1,964.45	\$1,882.60	\$1,800.74	30				
50	10	CPR-137G	EAR99	PEWCT1115	\$2,010.08	\$1,929.68	\$1,849.27	\$1,768.87	31				

*These WG crossguide couplers are available as assemblies with termination and/or with WG to Coax Adapters, see WG Coupler Assemblies or visit our website

WAVEGUIDE COUPLER ASSEMBLIES

See Our Website For Current Pricing & Real-Time Stock Availability!

WG Crossguide Coupler	WG Crossguide Coupler with Termination	WG Crossguide Coupler with Termination & Coax Adapter SMA/ Type N	Conn. Type
PEWCP1035	PEWCT1000	PEWCT1044	2.92mm
PEWCP1036	PEWCT1001	PEWCT1045	2.92mm
PEWCP1037	PEWCT1002	PEWCT1046	2.92mm
PEWCP1038	PEWCT1003	PEWCT1047	2.92mm
PEWCP1039	PEWCT1004	PEWCT1048	SMA
PEWCP1040	PEWCT1005	PEWCT1049	SMA
PEWCP1041	PEWCT1006	PEWCT1050	SMA
PEWCP1042	PEWCT1007	PEWCT1051	SMA
PEWCP1043	PEWCT1008	PEWCT1052	SMA
PEWCP1044	PEWCT1009	PEWCT1053	SMA
PEWCP1045	PEWCT1010	PEWCT1054	SMA
PEWCP1046	PEWCT1011	PEWCT1055	SMA
PEWCP1047	PEWCT1012	PEWCT1056	SMA
PEWCP1048	PEWCT1013	PEWCT1057	SMA
PEWCP1049	PEWCT1014	PEWCT1058	SMA
PEWCP1050	PEWCT1015	PEWCT1059	SMA
PEWCP1051	PEWCT1016	PEWCT1060	SMA
		PEWCT1064	N
PEWCP1052	PEWCT1017	PEWCT1061	SMA
		PEWCT1065	N
PEWCP1053	PEWCT1018	PEWCT1062	SMA
		PEWCT1066	N
PEWCP1054	PEWCT1019	PEWCT1063	SMA
		PEWCT1067	N
PEWCP1055	PEWCT1020	PEWCT1068	SMA
		PEWCT1076	N
PEWCP1056	PEWCT1021	PEWCT1069	SMA
		PEWCT1077	N
PEWCP1057	PEWCT1022	PEWCT1070	SMA
		PEWCT1078	N
PEWCP1058	PEWCT1023	PEWCT1071	SMA
		PEWCT1079	N
PEWCP1059	PEWCT1024	PEWCT1072	SMA
		PEWCT1080	N
PEWCP1060	PEWCT1025	PEWCT1073	SMA
		PEWCT1081	N

WG Crossguide Coupler	WG Crossguide Coupler with Termination	WG Crossguide Coupler with Termination & Coax Adapter SMA/ Type N	Conn. Type
PEWCP1061	PEWCT1026	PEWCT1074	SMA
		PEWCT1082	N
PEWCP1062	PEWCT1027	PEWCT1075	SMA
		PEWCT1083	N
PEWCP1063	PEWCT1028	PEWCT1084	SMA
		PEWCT1092	N
PEWCP1064	PEWCT1029	PEWCT1085	SMA
		PEWCT1093	N
PEWCP1065	PEWCT1030	PEWCT1086	SMA
		PEWCT1094	N
PEWCP1066	PEWCT1031	PEWCT1087	SMA
		PEWCT1095	N
PEWCP1067	PEWCT1032	PEWCT1088	SMA
		PEWCT1096	N
PEWCP1068	PEWCT1033	PEWCT1089	SMA
		PEWCT1097	N
PEWCP1069	PEWCT1034	PEWCT1090	SMA
		PEWCT1098	N
PEWCP1070	PEWCT1035	PEWCT1091	SMA
		PEWCT1099	N
PEWCP1071	PEWCT1036	PEWCT1100	SMA
		PEWCT1108	N
PEWCP1072	PEWCT1037	PEWCT1101	SMA
		PEWCT1109	N
PEWCP1073	PEWCT1038	PEWCT1102	SMA
		PEWCT1110	N
PEWCP1074	PEWCT1039	PEWCT1103	SMA
		PEWCT1111	N
PEWCP1075	PEWCT1040	PEWCT1104	SMA
		PEWCT1112	N
PEWCP1076	PEWCT1041	PEWCT1105	SMA
		PEWCT1113	N
PEWCP1077	PEWCT1042	PEWCT1106	SMA
		PEWCT1114	N
PEWCP1078	PEWCT1043	PEWCT1107	SMA
		PEWCT1115	N

WAVEGUIDE DETECTORS



Connector 1	RF Frequency (GHz.)	Voltage Sensitivity (V/nW)	Input Power (dBm)	Connector 2	ECCN	Model No	1	2-4	5-9	10+	R O W
WR-28 UG-599/U	26.5 - 40	-1,000	20	SMA Female	EAR99	PE80T3005	\$3,356.18	\$3,221.93	\$3,087.69	\$2,953.44	32
WR-22 UG-383/U	33 - 50	-800		SMA Female	EAR99	PE80T3004	\$4,110.42	\$3,966.56	\$3,822.69	\$3,699.38	33
WR-19 UG-383/U	40 - 60	-800		SMA Female	EAR99	PE80T3003	\$3,629.29	\$3,484.12	\$3,338.95	\$3,193.78	34
WR-15 UG-385/U	50 - 75	-700		SMA Female	EAR99	PE80T3002	\$3,806.56	\$3,654.30	\$3,502.04	\$3,349.77	35
WR-12 UG-387/U	60 - 90	-900		SMA Female	EAR99	PE80T3001	\$4,112.40	\$3,947.90	\$3,783.41	\$3,618.91	36
WR-10 UG-387/U	75 - 100	-900		SMA Female	EAR99	PE80T3000	\$3,470.82	\$3,331.99	\$3,193.15	\$3,054.32	37

Waveguides

WAVEGUIDE DIRECT READ ATTENUATORS



WG Type	RF Freq. (GHz.)	Max Atten (dB)	IL (dB)	Max VSWR	Input Power (Watts)	Flange Type	ECCN	Model No	1	2-4	5-9	10+	ROW
WR-10	75 - 110	50	1	1.2:1	0.2	Round Cover UG-387/U-Mod	EAR99	PE-W10AT5001	\$5,198.54	\$4,990.60	\$4,782.66	\$4,574.72	38
WR-12	60 - 90		0.9	1.2:1	0.2	Round Cover UG-387/U	EAR99	PE-W12AT5001	\$5,617.33	\$5,420.72	\$5,224.12	\$5,055.60	39
WR-15	50 - 75		0.8	1.2:1	0.3	Round Cover UG-385/U	EAR99	PE-W15AT5001	\$5,401.28	\$5,185.23	\$4,969.18	\$4,753.13	40
WR-19	40 - 60		0.7	1.15:1	0.2	Round Cover UG-383/U-Mod	EAR99	PE-W19AT5001	\$5,198.54	\$4,990.60	\$4,782.66	\$4,574.72	41
WR-22	33 - 50	60	0.6	1.15:1	0.4	Round Cover UG-383/U	EAR99	PE-W22AT5001	\$5,401.28	\$5,185.23	\$4,969.18	\$4,753.13	42
WR-28	26.5 - 40		1.15:1	0.5	EAR99		PE-W22AT5002	\$5,200.00	\$4,992.00	\$4,784.00	\$4,576.00	43	
WR-28	26.5 - 40	50	0.5	1.15:1	0.5	Square Cover UG-599/U	EAR99	PE-W28AT5001	\$5,401.28	\$5,185.23	\$4,969.18	\$4,753.13	44
WR-42	18 - 26.5			1.15:1	1	Square Cover UG-595/U	EAR99	PE-W42AT5001	\$5,617.33	\$5,392.64	\$5,167.94	\$4,943.25	45

WAVEGUIDE ELECTROMECHANICAL RELAY SWITCHES



Features:
 A: Absorptive
 AR: Auto Reset
 F: Failsafe
 D: Diode
 GR: Global Reset
 H: Hot Switches
 I: Indicators
 L: Latching
 N: Normally Open
 NT: Non-Terminated
 P: Pulse
 R: Reflective
 RS: Reset
 S: Self Cut Off
 SI: Set Indicator
 T: Terminated
 Latching
 TTL: TTL Logic
 V: Viewing Window

WG Type	Switch Type	RF Freq. (GHz.)	Actuator / Features	IL (dB)	Iso (dB)	DC Power (V)	ECCN	Model No	1	2-4	5-9	10+	ROW
WR-28	SPDT	26.5 - 40	B, L, S, I, M	0.15	55	12	EAR99	PEWGS6002	\$3,518.57	\$3,377.83	\$3,237.08	\$3,096.34	46
				0.15	55	28	EAR99	PEWGS6000	\$3,490.70	\$3,351.07	\$3,211.44	\$3,071.82	47
WR-34	SPDT/DPDT	22 - 33	L, S, SI, M, V	0.15	55	12	EAR99	PEWGS6003	\$3,983.33	\$3,824.00	\$3,664.66	\$3,505.33	48
				0.15	55	28	EAR99	PEWGS6001	\$3,626.84	\$3,481.77	\$3,336.69	\$3,191.62	49
				0.15	60	12	EAR99	PEWGS6042	\$4,316.67	\$4,144.00	\$3,971.34	\$3,798.67	50
				0.15	60	28	EAR99	PEWGS6040	\$4,316.67	\$4,144.00	\$3,971.34	\$3,798.67	51
WR-42	SPDT	18 - 26.5	L, TTL, S, SI, M, V	0.15	60	12	EAR99	PEWGS6043	\$4,483.33	\$4,304.00	\$4,124.66	\$3,945.33	52
				0.15	60	28	EAR99	PEWGS6041	\$4,483.33	\$4,304.00	\$4,124.66	\$3,945.33	53
				0.15	60	12	EAR99	PEWGS6006	\$3,518.57	\$3,377.83	\$3,237.08	\$3,096.34	54
				0.15	60	28	EAR99	PEWGS6004	\$3,490.70	\$3,351.07	\$3,211.44	\$3,071.82	55
WR-62	SPDT	12.4 - 18	B, L, S, I, M	0.15	60	12	EAR99	PEWGS6007	\$3,518.57	\$3,377.83	\$3,237.08	\$3,096.34	56
				0.15	60	28	EAR99	PEWGS6005	\$3,626.84	\$3,481.77	\$3,336.69	\$3,191.62	57
				0.1	60	12	EAR99	PEWGS6010	\$3,386.50	\$3,251.04	\$3,115.58	\$2,980.12	58
				0.1	60	28	EAR99	PEWGS6008	\$3,490.70	\$3,351.07	\$3,211.44	\$3,071.82	59
WR-75	SPDT	10 - 15	B, L, TTL, S, I, M	0.1	60	12	EAR99	PEWGS6011	\$3,386.50	\$3,251.04	\$3,115.58	\$2,980.12	60
				0.1	60	28	EAR99	PEWGS6009	\$4,077.29	\$3,914.20	\$3,751.11	\$3,588.02	61
				0.05	75	12	EAR99	PEWGS6014	\$3,386.50	\$3,251.04	\$3,115.58	\$2,980.12	62
				0.05	75	28	EAR99	PEWGS6012	\$3,626.84	\$3,481.77	\$3,336.69	\$3,191.62	63
WR-90	SPDT	8.2 - 12.4	B, L, S, I, M	0.05	75	12	EAR99	PEWGS6015	\$3,386.50	\$3,251.04	\$3,115.58	\$2,980.12	64
				0.05	75	28	EAR99	PEWGS6013	\$3,951.63	\$3,793.56	\$3,635.50	\$3,477.43	65
				0.07	80	12	EAR99	PEWGS6018	\$3,518.57	\$3,377.83	\$3,237.08	\$3,096.34	66
				0.07	80	28	EAR99	PEWGS6016	\$3,626.84	\$3,481.77	\$3,336.69	\$3,191.62	67
WR-102	SPDT/DPDT	7 - 11	B, L, TTL, S, I, M	0.07	80	12	EAR99	PEWGS6019	\$4,138.68	\$3,973.13	\$3,807.59	\$3,642.04	68
				0.07	80	28	EAR99	PEWGS6017	\$3,626.84	\$3,481.77	\$3,336.69	\$3,191.62	69
				0.06	80	12	EAR99	PEWGS6038	\$4,316.67	\$4,144.00	\$3,971.34	\$3,798.67	70
				0.06	80	28	EAR99	PEWGS6036	\$4,316.67	\$4,144.00	\$3,971.34	\$3,798.67	71
WR-112	SPDT	7.05 - 10	L, TTL, S, SI, M, V	0.06	80	12	EAR99	PEWGS6037	\$4,483.33	\$4,304.00	\$4,124.66	\$3,945.33	72
				0.06	80	28	EAR99	PEWGS6039	\$4,483.33	\$4,304.00	\$4,124.66	\$3,945.33	73
				0.05	80	12	EAR99	PEWGS6022	\$3,386.50	\$3,251.04	\$3,115.58	\$2,980.12	74
				0.05	80	28	EAR99	PEWGS6020	\$3,490.70	\$3,351.07	\$3,211.44	\$3,071.82	75
WR-137	SPDT	5.85 - 8.2	B, L, S, I, M	0.05	80	12	EAR99	PEWGS6023	\$3,518.57	\$3,377.83	\$3,237.08	\$3,096.34	76
				0.05	80	28	EAR99	PEWGS6021	\$3,490.70	\$3,351.07	\$3,211.44	\$3,071.82	77
				0.02	70	12	EAR99	PEWGS6026	\$3,386.50	\$3,251.04	\$3,115.58	\$2,980.12	78
				0.02	70	28	EAR99	PEWGS6024	\$3,626.84	\$3,481.77	\$3,336.69	\$3,191.62	79
WR-159	SPDT/DPDT	4.9 - 7.05	B, L, TTL, S, I, M	0.02	70	12	EAR99	PEWGS6027	\$3,386.50	\$3,251.04	\$3,115.58	\$2,980.12	80
				0.02	70	28	EAR99	PEWGS6025	\$3,490.70	\$3,351.07	\$3,211.44	\$3,071.82	81
				0.06	70	12	EAR99	PEWGS6034	\$4,316.67	\$4,144.00	\$3,971.34	\$3,798.67	82
				0.06	70	28	EAR99	PEWGS6032	\$4,316.67	\$4,144.00	\$3,971.34	\$3,798.67	83
WR-187	SPDT/DPDT	3.95 - 5.85	L, S, SI, M, V	0.06	70	12	EAR99	PEWGS6035	\$4,483.33	\$4,304.00	\$4,124.66	\$3,945.33	84
				0.02	80	12	EAR99	PEWGS6030	\$4,316.67	\$4,144.00	\$3,971.34	\$3,798.67	86
				0.02	80	28	EAR99	PEWGS6028	\$4,316.37	\$4,143.72	\$3,971.06	\$3,798.41	87
				0.002	80	12	EAR99	PEWGS6031	\$4,483.33	\$4,304.00	\$4,124.66	\$3,945.33	88
				0.02	80	28	EAR99	PEWGS6029	\$4,483.33	\$4,304.00	\$4,124.66	\$3,945.33	89

DOUBLE RIDGE WAVEGUIDE ELECTROMECHANICAL RELAY SWITCHES



Features:

- A: Absorptive
- AR: Auto Reset
- F: Failsafe
- D: Diode
- GR: Global Reset
- H: Hot Switches
- I: Indicators
- L: Latching
- N: Normally Open
- NT: Non-Terminated
- P: Pulse
- Latching
- R: Reflective
- RS: Reset
- S: Self Cut Off
- SI: Set Indicator
- T: Terminated
- TTL: TTL Logic
- V: Viewing Window

WG Type	Switch Type	RF Freq. (GHz.)	Actuator / Features	IL (dB)	Iso (dB)	DC Power (V)	ECCN	Model No	1	2-4	5-9	10+	ROW	
WRD-180	SPDT/DPDT	18 - 40	L, S, SI, M, V	0.4	50	12	EAR99	PEWGS6054	\$8,483.33	\$8,144.00	\$7,804.66	\$7,465.33	90	
				0.4	50	28	EAR99	PEWGS6052	\$8,483.33	\$8,144.00	\$7,804.66	\$7,465.33	91	
			L, TTL, S, SI, M, V	0.4	50	12	EAR99	PEWGS6055	\$8,650.00	\$8,304.00	\$7,958.00	\$7,612.00	92	
WRD-650		L, S, SI, M, V	6.5 - 18	L, S, SI, M, V	0.4	50	28	EAR99	PEWGS6053	\$8,650.00	\$8,304.00	\$7,958.00	\$7,612.00	93
					0.35	60	12	EAR99	PEWGS6046	\$7,650.00	\$7,344.00	\$7,038.00	\$6,732.00	94
		L, TTL, S, SI, M, V		0.35	60	28	EAR99	PEWGS6044	\$7,650.00	\$7,344.00	\$7,038.00	\$6,732.00	95	
WRD-750	L, S, SI, M, V	7.5 - 18	L, S, SI, M, V	0.35	60	12	EAR99	PEWGS6047	\$7,816.67	\$7,504.00	\$7,191.34	\$6,878.67	96	
				0.35	60	28	EAR99	PEWGS6045	\$7,816.67	\$7,504.00	\$7,191.34	\$6,878.67	97	
			L, TTL, S, SI, M, V	0.3	60	12	EAR99	PEWGS6050	\$7,650.00	\$7,344.00	\$7,038.00	\$6,732.00	98	
			L, S, SI, M, V	0.3	60	28	EAR99	PEWGS6048	\$7,650.00	\$7,344.00	\$7,038.00	\$6,732.00	99	
			L, TTL, S, SI, M, V	0.3	60	12	EAR99	PEWGS6051	\$7,816.67	\$7,504.00	\$7,191.34	\$6,878.67	1	
			L, S, SI, M, V	0.3	60	28	EAR99	PEWGS6049	\$7,816.67	\$7,504.00	\$7,191.34	\$6,878.67	2	

ELECTROMECHANICAL RELAY SWITCHES

see page 288

FLEXIBLE WAVEGUIDES

Seamless



Waveguide Type	RF Frequency (GHz.)	IL (dB)	Max VSWR	Length (in)	Flange Type	ECCN	Model No	1	2-4	5-9	10+	ROW
WR-22	33 - 50	0.49	1.2:1	6	Round Cover UG-383/U	EAR99	PE-W22SF005-6	\$1,638.39	\$1,572.85	\$1,507.32	\$1,441.78	3
		0.49	1.2:1	12	Round Cover UG-383/U	EAR99	PE-W22SF005-12	\$2,493.85	\$2,394.10	\$2,294.34	\$2,194.59	4
		0.49	1.2:1	24	Round Cover UG-383/U	EAR99	PE-W22SF005-24	\$3,313.56	\$3,181.02	\$3,048.48	\$2,915.93	5
WR-28	26.5 - 40	0.49	1.2:1	12	Square Cover UG-599/U	EAR99	PE-W28SF005-12	\$1,388.67	\$1,333.12	\$1,277.58	\$1,222.03	6
		0.98	1.2:1	24	Square Cover UG-599/U	EAR99	PE-W28SF005-24	\$2,208.58	\$2,120.24	\$2,031.89	\$1,943.55	7
		1.47	1.2:1	36	Square Cover UG-599/U	EAR99	PE-W28SF005-36	\$3,081.92	\$2,958.64	\$2,835.37	\$2,712.09	8
WR-34	22 - 33	0.4	1.15:1	12	Square Cover UG-1530/U	EAR99	PE-W34SF005-12	\$1,335.25	\$1,281.84	\$1,228.43	\$1,175.02	9
		0.8	1.15:1	24	Square Cover UG-1530/U	EAR99	PE-W34SF005-24	\$2,125.68	\$2,040.65	\$1,955.63	\$1,870.60	10
		1.2	1.15:1	36	Square Cover UG-1530/U	EAR99	PE-W34SF005-36	\$3,081.92	\$2,958.64	\$2,835.37	\$2,712.09	11
WR-42	18 - 26.5	0.27	1.15:1	12	Square Cover UG-595/U	EAR99	PE-W42SF005-12	\$1,172.85	\$1,125.94	\$1,079.02	\$1,032.11	12
		0.54	1.15:1	24	Square Cover UG-595/U	EAR99	PE-W42SF005-24	\$1,905.44	\$1,829.22	\$1,753.00	\$1,676.79	13
		0.81	1.15:1	36	Square Cover UG-595/U	EAR99	PE-W42SF005-36	\$2,641.64	\$2,535.97	\$2,430.31	\$2,324.64	14
WR-51	15 - 22	0.18	1.1:1	12	Square Cover	EAR99	PE-W51SF005-12	\$1,139.25	\$1,093.68	\$1,048.11	\$1,002.54	15
		0.36	1.1:1	24	Square Cover	EAR99	PE-W51SF005-24	\$1,840.88	\$1,767.24	\$1,693.61	\$1,619.97	16
		0.54	1.1:1	36	Square Cover	EAR99	PE-W51SF005-36	\$2,549.44	\$2,447.46	\$2,345.48	\$2,243.51	17
WR-62	12.4 - 18	0.14	1.08:1	12	Square Cover UG-419/U	EAR99	PE-W62SF005-12	\$1,125.94	\$1,080.90	\$1,035.86	\$990.83	18
		0.28	1.08:1	24	Square Cover UG-419/U	EAR99	PE-W62SF005-24	\$1,625.52	\$1,560.50	\$1,495.48	\$1,430.46	19
		0.42	1.08:1	36	Square Cover UG-419/U	EAR99	PE-W62SF005-36	\$2,348.47	\$2,254.53	\$2,160.59	\$2,066.65	20
WR-75	10 - 15	0.12	1.07:1	12	Square Cover	EAR99	PE-W75SF005-12	\$1,100.70	\$1,056.67	\$1,012.64	\$968.62	21
		0.24	1.07:1	24	Square Cover	EAR99	PE-W75SF005-24	\$1,779.00	\$1,707.84	\$1,636.68	\$1,565.52	22
		0.36	1.07:1	36	Square Cover	EAR99	PE-W75SF005-36	\$2,417.04	\$2,320.36	\$2,223.68	\$2,127.00	23
WR-90	8.2 - 12.4	0.09	1.07:1	12	Square Cover UG-39/U	EAR99	PE-W90SF005-12	\$1,170.98	\$1,124.14	\$1,077.30	\$1,030.46	24
		0.18	1.07:1	24	CPR-90G	EAR99	PE-W90SF006-24	\$1,695.00	\$1,627.20	\$1,559.40	\$1,491.60	25
		0.18	1.07:1	24	Square Cover UG-39/U	EAR99	PE-W90SF005-24	\$1,761.11	\$1,690.67	\$1,620.22	\$1,549.78	26
		0.27	1.07:1	36	CPR-90G	EAR99	PE-W90SF006-36	\$2,299.36	\$2,207.39	\$2,115.41	\$2,023.44	27
		0.27	1.07:1	36	Square Cover UG-39/U	EAR99	PE-W90SF005-36	\$2,389.04	\$2,293.48	\$2,197.92	\$2,102.36	28
		0.9	1.07:1	36	CPR-90G	EAR99	PE-W90SF006-12	\$1,083.68	\$1,040.33	\$996.99	\$953.64	29
WR-112	7.05 - 10	0.08	1.07:1	12	CPR-112G	EAR99	PE-W112SF006-12	\$1,174.00	\$1,127.04	\$1,080.08	\$1,033.12	30
		0.08	1.07:1	24	Square Cover UG-51/U	EAR99	PE-W112SF005-12	\$1,174.00	\$1,127.04	\$1,080.08	\$1,033.12	31
		0.16	1.07:1	24	CPR-112G	EAR99	PE-W112SF006-24	\$1,847.81	\$1,773.90	\$1,699.99	\$1,626.07	32
		0.16	1.07:1	24	Square Cover UG-51/U	EAR99	PE-W112SF005-24	\$1,847.81	\$1,773.90	\$1,699.99	\$1,626.07	33
		0.24	1.07:1	36	CPR-112G	EAR99	PE-W112SF006-36	\$2,528.60	\$2,427.46	\$2,326.31	\$2,225.17	34
		0.24	1.07:1	36	Square Cover UG-51/U	EAR99	PE-W112SF005-36	\$2,528.60	\$2,427.46	\$2,326.31	\$2,225.17	35
WR-137	5.85 - 8.2	0.06	1.07:1	12	CPR-137G	EAR99	PE-W137SF006-12	\$1,201.77	\$1,153.70	\$1,105.63	\$1,057.56	36
		0.06	1.07:1	24	Round Cover UG-344/U	EAR99	PE-W137SF005-12	\$1,305.97	\$1,253.73	\$1,201.49	\$1,149.25	37
		0.12	1.07:1	24	CPR-137G	EAR99	PE-W137SF006-24	\$2,031.90	\$1,950.62	\$1,869.35	\$1,788.07	38
		0.12	1.07:1	24	Round Cover UG-344/U	EAR99	PE-W137SF005-24	\$2,077.05	\$1,993.97	\$1,910.89	\$1,827.80	39
		0.18	1.07:1	36	CPR-137G	EAR99	PE-W137SF006-36	\$2,799.52	\$2,687.54	\$2,575.56	\$2,463.58	40
		0.18	1.07:1	36	Round Cover UG-344/U	EAR99	PE-W137SF005-36	\$2,848.13	\$2,734.20	\$2,620.28	\$2,506.35	41

See Our Website For Current Pricing & Real-Time Stock Availability!

Waveguides

Twistable



Waveguide Type	RF Frequency (GHz.)	IL (dB)	Max VSWR	Length (in)	Flange Type	ECCN	Model No	1 Pc. Price	See Web for Volume Pricing	R O W
WR-22	33 - 50	0.6	1.3:1	6	Round Cover UG-383/U	EAR99	PE-W22TF005-6	\$822.80	See Web for Volume Pricing	42
		0.6	1.3:1	12	Round Cover UG-383/U	EAR99	PE-W22TF005-12	\$837.24		43
		0.6	1.3:1	24	Round Cover UG-383/U	EAR99	PE-W22TF005-24	\$880.54		44
WR-28	26.5 - 40	0.6	1.3:1	12	Square Cover UG-599/U	EAR99	PE-W28TF005-12	\$542.15		45
		1.2	1.3:1	24	Square Cover UG-599/U	EAR99	PE-W28TF005-24	\$586.72		46
		1.8	1.3:1	36	Square Cover UG-599/U	EAR99	PE-W28TF005-36	\$593.32		47
WR-34	22 - 33	0.5	1.22:1	12	Square Cover UG-1530/U	EAR99	PE-W34TF005-12	\$504.00		48
		1	1.22:1	24	Square Cover UG-1530/U	EAR99	PE-W34TF005-24	\$567.46		49
		1.5	1.22:1	36	Square Cover UG-1530/U	EAR99	PE-W34TF005-36	\$607.42		50
WR-42	18 - 26.5	0.35	1.3:1	12	Square Cover UG-595/U	EAR99	PE-W42TF005-12	\$466.51		51
		0.7	1.3:1	24	Square Cover UG-595/U	EAR99	PE-W42TF005-24	\$495.53		52
		1.05	1.35:1	36	Square Cover UG-595/U	EAR99	PE-W42TF005-36	\$518.46		53
WR-51	15 - 22	0.55	1.15:1	12	Square Cover	EAR99	PE-W51TF005-12	\$492.80		54
		1.1	1.15:1	24	Square Cover	EAR99	PE-W51TF005-24	\$512.45		55
		1.65	1.15:1	36	Square Cover	EAR99	PE-W51TF005-36	\$570.41		56
WR-62	12.4 - 18	0.28	1.1:1	12	Square Cover UG-419/U	EAR99	PE-W62TF005-12	\$549.63		57
		0.56	1.1:1	24	Square Cover UG-419/U	EAR99	PE-W62TF005-24	\$582.40		58
		0.84	1.1:1	36	Square Cover UG-419/U	EAR99	PE-W62TF005-36	\$653.53		59
WR-75	10 - 15	0.18	1.1:1	12	Square Cover	EAR99	PE-W75TF005-12	\$602.38		60
		0.36	1.1:1	24	Square Cover	EAR99	PE-W75TF005-24	\$599.43		61
		0.54	1.1:1	36	Square Cover	EAR99	PE-W75TF005-36	\$674.31		62
WR-90	8.2 - 12.4	0.15	1.07:1	12	CPR-90G	EAR99	PE-W90TF006-12	\$512.45		63
		0.15	1.1:1		Square Cover UG-39/U	EAR99	PE-W90TF005-12	\$567.46		64
		0.3	1.07:1	24	CPR-90G	EAR99	PE-W90TF006-24	\$622.36		65
		0.36	1.1:1		Square Cover UG-39/U	EAR99	PE-W90TF005-24	\$695.09	66	
		0.45	1.07:1	36	CPR-90G	EAR99	PE-W90TF006-36	\$683.09	67	
		0.45	1.1:1		Square Cover UG-39/U	EAR99	PE-W90TF005-36	\$710.41	68	
WR-112	7.05 - 10	0.12	1.07:1	12	CPR-112G	EAR99	PE-W112TF006-12	\$647.38	69	
		0.12	1.3:1		Square Cover UG-51/U	EAR99	PE-W112TF005-12	\$668.69	70	
		0.24	1.07:1	24	CPR-112G	EAR99	PE-W112TF006-24	\$726.02	71	
		0.24	1.07:1		Square Cover UG-51/U	EAR99	PE-W112TF005-24	\$683.08	72	
		0.36	1.07:1	36	CPR-112G	EAR99	PE-W112TF006-36	\$758.14	73	
		0.36	1.07:1		Square Cover UG-51/U	EAR99	PE-W112TF005-36	\$758.14	74	
WR-137	5.85 - 8.2	0.07	1.05:1	12	CPR-137G	EAR99	PE-W137TF006-12	\$622.36	75	
		0.07	1.05:1		Round Cover UG-344/U	EAR99	PE-W137TF005-12	\$632.16	76	
		0.14	1.05:1	24	CPR-137G	EAR99	PE-W137TF006-24	\$710.41	77	
		0.14	1.05:1		Round Cover UG-344/U	EAR99	PE-W137TF005-24	\$778.21	78	
		0.18	1.05:1	36	Round Cover UG-344/U	EAR99	PE-W137TF005-36	\$878.25	79	
		0.21	1.05:1		CPR-137G	EAR99	PE-W137TF006-36	\$809.38	80	

WAVEGUIDE ISOLATORS



WG Type	RF Freq. (GHz.)	Isolation (dB)	IL (dB)	VSWR	Flange Type	ECCN	Model No	1	2-4	5-9	10+	R O W
WR-10	75 - 110	25	2.3	1.5:1	UG-387/U-Mod		PEWIR1000	\$2,616.36	\$2,511.71	\$2,407.05	\$2,302.40	81
WR-12	60 - 90		2	1.5:1	UG-387/U		PEWIR1001	\$2,699.00	\$2,591.04	\$2,483.08	\$2,375.12	82
WR-15	50 - 75		1.8	1.4:1	UG-385/U		PEWIR1002	\$2,599.00	\$2,495.04	\$2,391.08	\$2,287.12	83
WR-19	40 - 60		1.6	1.4:1	UG-383/U-Mod		PEWIR1003	\$2,699.00	\$2,591.04	\$2,483.08	\$2,375.12	84
WR-22	33 - 50		1.5	1.4:1	UG-383/U		PEWIR1004	\$2,651.82	\$2,545.75	\$2,439.67	\$2,333.60	85
WR-28	26.5 - 40	25	1.2	1.4:1	UG-383/U		PEWIR1014	Call	Call	Call	Call	86
					UG-599/U		PEWIR1005	Call	Call	Call	Call	87
					UG-599/U		PEWIR1011	Call	Call	Call	Call	88
WR-42	18 - 26.5	18	0.4	1.3:1	UG-597/U		PEWIR1010	\$2,899.00	\$2,783.04	\$2,667.08	\$2,551.12	89
WR-62	12.4 - 18	18	0.4	1.3:1	UG-1665/U		PEWIR1009	\$2,415.36	\$2,318.75	\$2,222.13	\$2,125.52	90
WR-75	10 - 15	18	0.5				PEWIR1008	\$2,308.03	\$2,215.71	\$2,123.39	\$2,031.07	91
WR-90	8.2 - 12.4	18	0.4	1.3:1	UG-135/U		PEWIR1007	\$2,260.10	\$2,169.70	\$2,079.29	\$1,988.89	92
WR-112	7.05 - 10	18	0.4	1.3:1	UG-138/U		PEWIR1006	\$2,268.15	\$2,177.42	\$2,086.70	\$1,995.97	93
								\$2,394.66	\$2,298.87	\$2,203.09	\$2,107.30	94

WAVEGUIDE LOW NOISE AMPLIFIERS



RF Freq. (GHz.)	Gain (dB)	Gain Variation ± (dB)	NF (dB)	P1dB (dBm)	IP3 (dBm)	Waveguide Type	ECCN	Model No	1	2-4	5-9	10+	ROW
26.5 - 40	47	2.5	3.2	20	25	WR-28	EAR99	PE15A1076	Call	Call	Call	Call	95
27 - 40	35	3	3	10	20		EAR99	PE15A1077	Call	Call	Call	Call	96

WAVEGUIDE MAGIC TEES



Waveguide Type	RF Frequency (GHz.)	Flange Type	IL (dB)	Min Isolation (dB)	ECCN	Model No	1	2-4	5-9	10+	ROW
WR-10	75 - 110	Round Cover UG-387/U-Mod	1	25	EAR99	PEWMT1000	\$2,577.73	\$2,474.62	\$2,371.51	\$2,268.40	97
WR-12	60 - 90	Round Cover UG-387/U			EAR99	PEWMT1001	\$2,604.23	\$2,500.06	\$2,395.89	\$2,291.72	98
WR-15	50 - 75	Round Cover UG-385/U			EAR99	PEWMT1002	\$2,470.19	\$2,371.38	\$2,272.57	\$2,173.77	99
WR-19	40 - 60	Round Cover UG-383/U-Mod	0.8		EAR99	PEWMT1003	\$2,227.89	\$2,138.77	\$2,049.66	\$1,960.54	1
WR-22	33 - 50	Round Cover UG-383/U	0.7		EAR99	PEWMT1004	\$2,227.89	\$2,138.77	\$2,049.66	\$1,960.54	2
WR-28	26.5 - 40	Square Cover UG-599/U	0.5		EAR99	PEWMT1005	\$2,122.20	\$2,037.31	\$1,952.42	\$1,867.54	3
WR-42	18 - 26.5	Square Cover UG-595/U		EAR99	PEWMT1006	\$2,080.59	\$1,997.37	\$1,914.14	\$1,830.92	4	

WAVEGUIDE ORTHOMODE TRANSDUCERS



RF Freq. (GHz.)	H to A IL (dB)	V to A IL (dB)	H to V Isolation (dB)	H to A Cross Polarization (dB)	V to A Cross Polarization (dB)	Waveguide Type	ECCN	Model No	1	2-4	5-9	10+	ROW
8.2 - 12.4						WR-90	EAR99	PEWOT0014	\$3,500.00	\$3,377.50	\$3,255.00	\$3,150.00	5
24 - 33	0.6		45	35	35	WR-34	EAR99	PEWOT0001	\$4,875.00	\$4,704.38	\$4,533.75	\$4,387.50	6
26.5 - 40	0.5	0.5	40	35	35	WR-28	EAR99	PEWOT0007	\$4,375.00	\$4,221.88	\$4,068.75	\$3,937.50	7
30 - 42				35	35		EAR99	PEWOT0003	\$4,625.00	\$4,463.13	\$4,301.25	\$4,162.50	8
60 - 90	1.2	0.8		35	35	WR-12	EAR99	PEWOT0009	\$4,400.00	\$4,246.00	\$4,092.00	\$3,960.00	9

WAVEGUIDE PHASE SHIFTERS



WG Type	RF Freq. (GHz.)	Phase Range (GHz.)	Input Power (Watts)	IL (dB)	Length (in)	Flange Type	ECCN	Model No	1	2-4	5-9	10+	ROW
WR-10	75 - 110	0 - 180°	0.6	1	3	Round Cover UG-387/U-Mod	EAR99	PE-W10PS1001	\$2,091.09	\$2,007.45	\$1,923.80	\$1,840.16	10
WR-12	60 - 90	0 - 180°	0.7	1	3	Round Cover UG-387/U	EAR99	PE-W12PS1001	\$2,172.64	\$2,085.73	\$1,998.83	\$1,911.92	11
WR-15	50 - 75	0 - 180°	0.8	1	3	Round Cover UG-385/U	EAR99	PE-W15PS1001	\$2,172.64	\$2,085.73	\$1,998.83	\$1,911.92	12
WR-19	40 - 60	0 - 180°	1	1	3	Round Cover UG-383/U-Mod	EAR99	PE-W19PS1001	\$2,091.09	\$2,007.45	\$1,923.80	\$1,840.16	13
WR-22	33 - 50	0 - 180°	1	1	4	Round Cover UG-383/U	EAR99	PE-W22PS1001	\$2,172.64	\$2,085.73	\$1,998.83	\$1,911.92	14
WR-28	26.5 - 40	0 - 180°	1		4	Square Cover UG-599/U	EAR99	PE-W28PS1002	\$2,699.00	\$2,591.04	\$2,483.08	\$2,375.12	15
WR-42	18 - 26.5	0 - 180°	1.5	1	4	Square Cover UG-595/U	EAR99	PE-W42PS1001	\$2,172.64	\$2,085.73	\$1,998.83	\$1,911.92	16

WAVEGUIDE PIN DIODE SWITCHES



WG Type	Switch Type	RF Freq. (GHz.)	IL (dB)	Min Isolation (dB)	Max Switching (in)	Flange Type	ECCN	Model No	1	2-4	5-9	10+	ROW
WR-10	SPST/ Reflective	75 - 110	5.5	20	300	Round Cover UG-387/U	EAR99	PE71S9003	\$8,336.00	\$8,002.56	\$7,669.12	\$7,335.68	17
	SPDT/ Reflective		7	20	300	Round Cover UG-387/U	EAR99	PE71S9004	\$9,899.00	\$9,503.04	\$9,107.08	\$8,711.12	18
WR-12	SPST/ Reflective	60 - 90	4.5	20	300	Round Cover UG-387/U	EAR99	PE71S9001	\$7,640.99	\$7,335.35	\$7,029.71	\$6,724.07	19
	SPDT/ Reflective		6	20	300	Round Cover UG-387/U	EAR99	PE71S9002	\$9,031.02	\$8,669.78	\$8,308.54	\$7,947.30	20

PIN DIODE SWITCHES, see page 295

WAVEGUIDE POLARIZERS



Band	RF Freq. (GHz.)	Typ Bandwidth (GHz)	Typ IL (dB)	Typ Axial Ratio (dB)	Length (in)	Flange Type	ECCN	Model No	1	2-4	5-9	10+	ROW
Ku	14 - 16	±1	0.5	1.1	3	Square Cover-UG-419/U-Mod	EAR99	PEWPL0000	\$4,000.00	\$3,860.00	\$3,720.00	\$3,600.00	21
K	20 - 22			1.1	2	Square Cover-UG-595/U-Mod	EAR99	PEWPL0001	Call	Call	Call	Call	22
	21 - 23			1.1	2	Square Cover-UG-595/U-Mod	EAR99	PEWPL0002	Call	Call	Call	Call	23
	23 - 25			1.1	2	Square Cover-UG-595/U-Mod	EAR99	PEWPL0003	Call	Call	Call	Call	24
				1.1	2	Square Cover-UG-595/U	EAR99	PEWPL0004	Call	Call	Call	Call	25
Ka	26 - 33	±3.5	0.3	1.1	2	Square Cover-UG-599/U-Mod	EAR99	PEWPL0005	\$4,000.00	\$3,860.00	\$3,720.00	\$3,600.00	26
	32 - 38	±2.6		1.1	2	Square Cover-UG-599/U-Mod	EAR99	PEWPL0007	Call	Call	Call	Call	28
V	58 - 63	±2.5	0.5	1.1	1	Round Cover-UG-385/U-Mod	EAR99	PEWPL0008	\$4,000.00	\$3,860.00	\$3,720.00	\$3,600.00	29
E	71 - 83	±6		1.1	1	Round Cover-UG-387/U-Mod	EAR99	PEWPL0009	Call	Call	Call	Call	30
	71 - 86	±0		1.1	1	Round Cover-UG-387/U-Mod	EAR99	PEWPL0010	Call	Call	Call	Call	31
W	92 - 96	±2	0.7	1.1	1	Round Cover-UG-387/U-Mod	EAR99	PEWPL0011	Call	Call	Call	Call	32

WAVEGUIDE POWER AMPLIFIERS



Waveguide Type	RF Frequency (GHz.)	Min Gain (dB)	Psat (dBm)	Flange Type	ECCN	Model No	1	2-4	5-9	10+	ROW
WR-12	70.5 - 76.5	25	20	Round Cover UG-387/U	EAR99	PE15A4023	\$10,766.99	\$10,336.31	\$9,905.63	\$9,474.95	33
	80.5 - 86.5	20	19	Round Cover UG-387/U	EAR99	PE15A4024	\$11,201.50	\$10,753.44	\$10,305.38	\$9,857.32	34

WAVEGUIDE SECTIONS



See Our Website For Current Pricing & Real-Time Stock Availability!

WG Type	RF Freq. (GHz.)	IL (dB)	Max VSWR	Length (in)	Flange Type	ECCN	Model No	1 Pc. Price	See Web for Volume Pricing	ROW
WR-5	140 - 220			1			EAR99 PEW05S000-1	\$569.00		35
				3			EAR99 PEW05S000-3	\$529.00		36
				6			EAR99 PEW05S000-6	\$679.00		37
				9			EAR99 PEW05S000-9	\$779.00		38
WR-6	110 - 170			12	Round Cover UG-387/U-Mod		EAR99 PEW05S000-12	\$899.00		39
				1			EAR99 PEW06S000-1	\$459.00		40
				3			EAR99 PEW06S000-3	\$499.00		41
				6			EAR99 PEW06S000-6	\$649.00		42
WR-8	90 - 140			9			EAR99 PEW06S000-9	\$749.00		43
				12			EAR99 PEW06S000-12	\$869.00		44
				1			EAR99 PEW08S000-1	\$399.00		45
				3			EAR99 PEW08S000-3	\$439.00		46
WR-10	75 - 110			6			EAR99 PEW08S000-6	\$599.00		47
				9			EAR99 PEW08S000-9	\$749.00		48
				12			EAR99 PEW08S000-12	\$869.00		49
				3			EAR99 PEW10S010-3	\$468.28		50
WR-12	60 - 90	0.25	1.06:1	3	Round Cover UG-387/U		EAR99 PE-W12S001-3	\$359.02		51
		0.64		9			EAR99 PE-W12S001-9	\$470.38		52
		0.82		12			EAR99 PE-W12S001-12	\$488.44		53
				1.15:1			3	EAR99 PEW12S010-3		\$359.02
WR-15	50 - 75		1.06:1	6	Round Cover UG-385/U		EAR99 PEW12S010-6	\$406.38		55
				9			EAR99 PEW12S010-9	\$470.38		56
				12			EAR99 PE-W15S001-12	\$383.74		57
				0.2			3	EAR99 PE-W15S001-3		\$419.94
WR-19	40 - 60	0.34	1.06:1	6	Round Cover UG-383/U-Mod		EAR99 PE-W15S001-6	\$459.92		59
		0.49		9			EAR99 PE-W15S001-9	\$640.93		60
		0.64		12			EAR99 PEW15S010-12	\$640.93		61
				3			EAR99 PE-W19S001-3	\$356.31		62
WR-22	33 - 50		1.06:1	6	Round Cover UG-383/U		EAR99 PE-W19S001-6	\$404.18		63
				9			EAR99 PE-W19S001-9	\$459.92		64
				12			EAR99 PE-W19S001-12	\$522.64		65
				0.15			3	EAR99 PEW19S010-3		\$356.31
WR-28	26.5 - 40		1.06:1	6	Square Cover UG-599/U		EAR99 PEW19S010-6	\$522.64		67
				9			EAR99 PE-W22S001-9	\$352.94		68
				12			EAR99 PE-W22S001-12	\$371.22		69
				0.25			3	EAR99 PE-W22S001-3		\$371.22
WR-34	20 - 33		1.06:1	4	Square Cover UG-1530/U		EAR99 PE-W22S001-4	\$420.07		71
				6			EAR99 PE-W22S001-6	\$420.07		72
				9			EAR99 PE-W22S001-9	\$505.22		73
				12			EAR99 PEW22S010-12	\$505.22		74
WR-42	18 - 26.5		1.06:1	3	Square Cover UG-595/U		EAR99 PEW22S010-3	\$399.00		75
				6			EAR99 PEWSP1000	\$590.48		76
				9			EAR99 PE-W28S001-9	\$363.03		77
				12			EAR99 PE-W28S001-12	\$435.54		78
WR-51	15 - 22		1.06:1	4	Square Cover UG-419/U		EAR99 PE-W28S001-4	\$524.92		79
				6			EAR99 PEW28S010-6	\$363.00		80
				9			EAR99 PEWSP1001	\$521.00		81
				12			EAR99 PEW28S010-12	\$521.00		82
WR-62	12.4 - 18		1.06:1	3	UBR180		EAR99 PEW28S010-3	\$363.00		83
				4			EAR99 PEWSP1001	\$521.00		84
				6			EAR99 PE-W51S001-6	\$394.02		85
				9			EAR99 PE-W51S001-9	\$394.02		86
WR-75	10 - 15		1.03:1	12	Square Cover		EAR99 PE-W51S001-12	\$495.97		87
				3			EAR99 PEWSP1004	\$555.75		88
				4			EAR99 PE-W62S002-4	\$450.15		89
				6			EAR99 PE-W62S002-6	\$450.15		90
WR-90	8.2 - 12.4	0.1	1.03:1	9	Square Cover UG-39/U		EAR99 PE-W62S002-9	\$504.33		91
				3			EAR99 PE-W62S002-3	\$571.02		92
				4			EAR99 PE-W62S002-4	\$571.02		93
				6			EAR99 PE-W62S002-6	\$312.60		94
WR-90	8.2 - 12.4	0.1	1.03:1	9	Square Cover UG-39/U		EAR99 PEWSP1005	\$527.96		95
				3			EAR99 PE-W62S001-3	\$312.60		96
				4			EAR99 PE-W62S001-4	\$312.60		97
				6			EAR99 PE-W62S001-6	\$319.34		98
WR-90	8.2 - 12.4	0.1	1.03:1	9	Square Cover UG-39/U		EAR99 PE-W62S001-9	\$326.06		99
				3			EAR99 PE-W62S001-3	\$332.78		1
				4			EAR99 PE-W75S001-4	\$321.43		2
				6			EAR99 PEWSP1006	\$538.38		3
WR-90	8.2 - 12.4	0.1	1.03:1	9	Square Cover UG-39/U		EAR99 PE-W75S001-9	\$319.34		4
				3			EAR99 PE-W75S001-3	\$321.43		5
				4			EAR99 PEWSP1006	\$538.38		
				6			EAR99 PE-W75S001-6	\$312.60		

See Web for Volume Pricing

Waveguides

See Our Website For Current Pricing & Real-Time Stock Availability!

WAVEGUIDE SECTIONS

WG Type	RF Freq. (GHz.)	IL (dB)	Max VSWR	Length (in)	Flange Type	ECCN	Model No	1 Pc. Price	See Web for Volume Pricing	ROW				
WR-90	8.2 - 12.4			3	Square Cover UG-39/U	EAR99	PE-W90S001-3	\$205.05	See Web for Volume Pricing	6				
					CPR-90G	EAR99	PE-W90S002-3	\$276.87		7				
				4	Square Cover UG-39/U	EAR99	PEWSP1007	\$555.75		8				
					CPR-90G	EAR99	PEWSP1008	\$562.68		9				
				6	Square Cover UG-39/U	EAR99	PE-W90S001-6	\$208.40		10				
					CPR-90G	EAR99	PE-W90S002-6	\$303.14		11				
				9	Square Cover UG-39/U	EAR99	PE-W90S001-9	\$238.66		12				
					CPR-90G	EAR99	PE-W90S002-9	\$297.71		13				
				12	Square Cover UG-39/U	EAR99	PE-W90S001-12	\$249.52		14				
					CPR-90G	EAR99	PE-W90S002-12	\$309.62		15				
				WR-112	7.05 - 10			3		Square Cover UG-51/U	EAR99	PE-W112S001-3	\$315.97	16
										CPR-112G	EAR99	PEWSP1009	\$573.10	17
4	CPR-112G	EAR99	PEWSP1010					\$576.59	18					
	Square Cover UG-51/U	EAR99	PE-W112S001-6					\$303.68	19					
9	Square Cover UG-51/U	EAR99	PE-W112S001-9					\$352.94	20					
	CPR-112G	EAR99	PE-W112S001-12					\$321.53	21					
WR-137	5.85 - 8.2			3	Round Cover UG-344/U	EAR99	PE-W137S001-3	\$337.18	22					
					CPR-137G	EAR99	PE-W137S002-3	\$336.14	23					
				4	Round Cover UG-344/U	EAR99	PEWSP1011	\$597.43	24					
					CPR-137G	EAR99	PEWSP1012	\$583.52	25					
				6	Round Cover UG-344/U	EAR99	PE-W137S001-6	\$339.39	26					
					CPR-137G	EAR99	PE-W137S002-6	Call	27					
				9	Round Cover UG-344/U	EAR99	PE-W137S001-9	\$371.21	28					
					CPR-137G	EAR99	PE-W137S002-9	\$349.55	29					
				12	Round Cover UG-344/U	EAR99	PE-W137S001-12	\$383.58	30					
					CPR-137G	EAR99	PE-W137S002-12	\$400.01	31					

WAVEGUIDE TERMINATIONS

Waveguide Type	RF Frequency (GHz.)	Input Power (Watts)	Max VSWR	Length (in)	Flange Type	ECCN	Model No	1 Pc. Price	See Web for Volume Pricing	ROW
WR-10	75 - 110	0.4	1.06:1		Round Cover UG-387/U	EAR99	PEW10TR0001	\$519.00	See Web for Volume Pricing	32
			1.25:1		Round Cover UG-387/U-Mod	EAR99	PE-W10TR1001	\$539.24		33
WR-12	60 - 90	0.6	1.2:1	2	Round Cover UG-387/U	EAR99	PE-W12TR1001	\$520.11	34	
WR-15	50 - 75	1	1.2:1		Round Cover UG-385/U	EAR99	PEW15TR0001	\$549.00	35	
					Round Cover UG-383/U	EAR99	PEW19TR0001	\$467.84	36	
WR-19	40 - 60	2	1.09:1		Round Cover UG-383/U-Mod	EAR99	PE-W19TR1001	\$486.09	37	
					Round Cover UG-383/U	EAR99	PE-W22TR1002	\$475.00	38	
WR-28	26.5 - 40		0.5		1.3:1	1	Square Cover UG-599/U	EAR99	PE6800	\$442.65
			0.5	1.05:1	2	Square Cover	EAR99	PE6809	\$847.84	40
			0.5	1.02:1		Square Cover UG-599/U	EAR99	PEWTR1000	\$656.81	41
			5	1.07:1	2	Square Cover UG-599/U	EAR99	PE-W28TR1001	\$520.11	42
			40	1.07:1	3	Square Cover	EAR99	PE6818	\$922.54	43
WR-34	22 - 33		75	1.2:1	4	Square Cover	EAR99	PE6200	\$881.27	44
			0.5	1.25:1	1	Square Cover	EAR99	PE6801	\$352.22	45
						Square Cover	EAR99	PE6810	\$815.22	46
			1	1.25:1		Square Cover UG-1530/U	EAR99	PEWTR1001	\$583.52	47
			45	1.1:1	4	Square Cover	EAR99	PE6819	\$1,322.79	48
75	1.1:1	Square Cover	EAR99	PE6828		\$1,209.77	49			
WR-42	18 - 26.5		0.5	1.25:1	1	Square Cover UG-597/U	EAR99	PE6802	\$432.24	50
			0.5	1.05:1	3	Square Cover	EAR99	PE6811	\$960.30	51
			1	1.02:1		Square Cover UG-595/U	EAR99	PEWTR1002	\$570.20	52
			6	1.08:1	3	Square Cover UG-595/U	EAR99	PE-W42TR1001	\$520.11	53
			50	1.07:1	4	Square Cover	EAR99	PE6820	\$925.08	54
			100	1.1:1		Square Cover	EAR99	PE6829	\$913.94	55

Waveguides

WAVEGUIDE TERMINATIONS

See Our Website For Current Pricing & Real-Time Stock Availability!

										R O W
Waveguide Type	RF Frequency (GHz.)	Input Power (Watts)	Max VSWR	Length (in)	Flange Type	ECCN	Model No	1 Pc. Price	See Web for Volume Pricing	R O W
WR-51	15 - 18	1	1.2:1	1	Square Cover	EAR99	PE6803	\$396.54	See Web for Volume Pricing	56
	15 - 22	1	1.05:1	3	Square Cover	EAR99	PE6812	\$992.32		57
		1	1.02:1		Square Cover	EAR99	PEWTR1003	\$591.86		58
	15 - 18	55	1.07:1	4	Square Cover	EAR99	PE6821	\$856.11		59
15 - 22	100	1.1:1	Square Cover		EAR99	PE6830	\$1,233.48	60		
WR-62	11.9 - 18	2	1.03:1		Square Cover	EAR99	PE6201A	Call		61
	12.4 - 18	1.5	1.02:1		Square Cover UG-419/U	EAR99	PEWTR1004	\$555.75		62
		2	1.2:1	1	Square Cover	EAR99	PE6804	\$445.73		63
		60	1.07:1	4	Square Cover	EAR99	PE6836	\$867.76		64
WR-75	10 - 15	175	1.1:1		Square Cover	EAR99	PE6831	\$1,233.49		65
		2	1.2:1	1	Square Cover	EAR99	PE6805	\$663.98		66
		2	1.05:1	4	Square Cover	EAR99	PE6814	\$801.74		67
		2.5	1.02:1		Square Cover	EAR99	PEWTR1005	\$598.53		68
		75	1.07:1	5	Square Cover	EAR99	PE6823	\$802.58	69	
WR-90	8.2 - 12.4	175	1.1:1	6	Square Cover	EAR99	PE6832	\$1,349.66	70	
		2	1.2:1	1	Square Cover UG-135/U	EAR99	PE6806	\$481.10	71	
		2	1.05:1	4	Square Cover	EAR99	PE6815	\$770.91	72	
		4	1.02:1		Square Cover UG-39/U	EAR99	PEWTR1006	\$548.55	73	
		4	1.02:1		CPR-90G	EAR99	PEWTR1007	\$559.38	74	
		90	1.07:1	6	Square Cover	EAR99	PE6824	\$1,141.86	75	
WR-102	7 - 11	200	1.1:1		Square Cover	EAR99	PE6833	\$1,502.44	76	
		2	1.2:1	1	Square Cover	EAR99	PE6807	\$408.11	77	
		2	1.05:1	4	Square Cover	EAR99	PE6816	\$713.43	78	
WR-112	7.05 - 10	300	1.1:1	7	Square Cover	EAR99	PE6834	\$1,537.02	79	
		2	1.2:1	1	Square Cover	EAR99	PE6808	\$444.80	80	
WR-112	7.05 - 10	5	1.02:1		Square Cover UG-51/U	EAR99	PEWTR1008	\$584.62	81	
		5	1.02:1		CPR-112G	EAR99	PEWTR1009	\$633.28	82	
		100	1.1:1	7	Square Cover	EAR99	PE6826	\$1,037.85	83	
		300	1.1:1		Square Cover	EAR99	PE6835	\$2,076.96	84	
WR-137	5.85 - 8.2	6	1.02:1		Round Cover UG-344/U	EAR99	PEWTR1010	\$617.10	85	

WAVEGUIDE TRANSITIONS

										R O W
WG 1 Type	Flange 1 Type	WG 2 Type	Flange 2 Type	VSWR	ECCN	Model No	1 Pc. Price	See Web for Volume Pricing	R O W	
WR-10	Round Cover UG-387/U-Mod	WR-12	Round Cover UG-387/U	1.6:1	EAR99	PE-W10TS12001A	\$1,252.04	See Web for Volume Pricing	86	
		WR-15	Round Cover UG-385/U	1.45:1	EAR99	PE-W10TS15001	\$1,252.04		87	
		WR-19	Round Cover UG-383/U-Mod	1.4:1	EAR99	PE-W10TS19001	\$1,311.36		88	
WR-12	Round Cover UG-387/U	WR-15	Round Cover UG-385/U	1.2:1	EAR99	PE-W12TS15001	\$1,302.12		89	
WR-15	Round Cover UG-385/U	WR-19	Round Cover UG-383/U-Mod	1.1:1	EAR99	PE-W15TS19001	\$1,302.12		90	
				1.15:1	EAR99	PE-W15TS22001	\$1,311.36		91	
WR-19	Round Cover UG-383/U-Mod	WR-22	Round Cover UG-383/U	1.5:1	EAR99	PE-W19TS22001	\$1,252.04		92	
				1.35:1	EAR99	PE-W19TS28001	\$1,302.12		93	
WR-22	Round Cover UG-383/U	WR-28	Square Cover UG-599/U	1.35:1	EAR99	PE-W22TS28001	\$1,302.12		94	
				1.35:1	EAR99	PE-W22TS42001	\$1,205.04		95	
WR-28	Square Cover UG-599/U	WR-42	Square Cover UG-595/U	1.2:1	EAR99	PE-W28TS42001	\$1,205.04		96	
				1.38:1	EAR99	PE-W28TS51001	\$1,362.50		97	
				1.08:1	EAR99	PEWTS1010	\$797.47		98	
WR-34	Square Cover UG-1530/U	WR-28	Square Cover UG-599/U	1.08:1	EAR99	PEWTS1010	\$797.47	99		
WR-42	Square Cover UG-595/U	WR-34	Square Cover UG-1530/U	1.08:1	EAR99	PEWTS1009	\$773.33	1		
WR-62	Square Cover UG-1665/U	WR-51	Square Cover	1.08:1	EAR99	PEWTS1007A	\$805.03	2		
WR-75	Square Cover	WR-62	Square Cover UG-1665/U	1.08:1	EAR99	PEWTS1006	\$836.43	3		
WR-90	Square Cover UG-39/U	WR-75	Square Cover	1.08:1	EAR99	PEWTS1004	\$847.56	4		
WR-112	Square Cover UG-51/U	WR-90	Square Cover UG-39/U	1.08:1	EAR99	PEWTS1002	\$897.04	5		
	CPR-112G	WR-90	CPR-90G	1.08:1	EAR99	PEWTS1003	\$851.46	6		
WR-137	Round Cover UG-344/U	WR-112	Square Cover UG-51/U	1.08:1	EAR99	PEWTS1000	\$958.90	7		
	CPR-137G	WR-112	CPR-112G	1.08:1	EAR99	PEWTS1001	\$965.11			

Waveguides

WAVEGUIDE TWISTS



WG Type	RF Freq. (GHz.)	Max VSWR	WG Offset Angle (Deg)	Length (in)	Flange Type	ECCN	Model No	1-9	10-24	25-49	50+	ROW	
WR-10	75 - 110	1.1:1	45 Left-hand	1	Round Cover UG-387/U-Mod	EAR99	PEW10TW1002	\$418.22	\$397.31	\$376.40	\$359.67	8	
			45 Right-hand		Round Cover UG-387/U-Mod	EAR99	PEW10TW1003	\$418.22	\$397.31	\$376.40	\$359.67	9	
		1.43:1	90		Round Cover UG-387/U-Mod	EAR99	PEW10TW1001	\$394.41	\$374.69	\$354.97	\$339.19	10	
WR-12	60 - 90	1.16:1	45 Left-hand	1	Round Cover UG-387/U	EAR99	PEW12TW1002	\$418.22	\$397.31	\$376.40	\$359.67	11	
			45 Right-hand		Round Cover UG-387/U	EAR99	PEW12TW1003	\$418.22	\$397.31	\$376.40	\$359.67	12	
		1.12:1	90		Round Cover UG-387/U-Mod	EAR99	PEW12TW001	\$467.86	\$444.47	\$421.07	\$402.36	13	
			90		Round Cover UG-387/U	EAR99	PEW12TW1001	\$467.86	\$444.47	\$421.07	\$402.36	14	
WR-15	50 - 75	1.11:1	45 Left-hand	1	Round Cover UG-385/U	EAR99	PEW15TW1002	\$418.22	\$397.31	\$376.40	\$359.67	15	
			45 Right-hand		Round Cover UG-385/U	EAR99	PEW15TW1003	\$418.22	\$397.31	\$376.40	\$359.67	16	
			90		Round Cover UG-385/U	EAR99	PEW15TW1001	\$394.41	\$374.69	\$354.97	\$339.19	17	
WR-19	40 - 60	1.25:1	45 Left-hand	1	Round Cover UG-383/U-Mod	EAR99	PEW19TW1002	\$418.22	\$397.31	\$376.40	\$359.67	18	
			45 Right-hand		Round Cover UG-383/U-Mod	EAR99	PEW19TW1003	\$418.22	\$397.31	\$376.40	\$359.67	19	
WR-22	33 - 50	1.02:1	45 Left-hand	2	Round Cover UG-383/U-Mod	EAR99	PEW19TW1001	\$368.60	\$350.17	\$331.74	\$317.00	20	
			45 Right-hand		Round Cover UG-383/U	EAR99	PEW22TW1002	\$418.22	\$397.31	\$376.40	\$359.67	21	
		1.15:1	90		Round Cover UG-383/U	EAR99	PEW22TW1003	\$418.22	\$397.31	\$376.40	\$359.67	22	
			1.02:1		90	Round Cover UG-383/U	EAR99	PEW22TW001	\$368.60	\$350.17	\$331.74	\$317.00	23
					90	Round Cover UG-383/U	EAR99	PEW22TW1001	\$368.60	\$350.17	\$331.74	\$317.00	24
WR-28	26.5 - 40	1.1:1	45 Right-hand	1	Square Cover UG-595/U	EAR99	PEW28TW001	\$447.50	\$425.13	\$402.75	\$384.85	25	
			45 Left-hand		Square Cover UG-599/U	EAR99	PEW28TW1002	\$447.50	\$425.13	\$402.75	\$384.85	26	
		1.09:1	45 Right-hand		Square Cover UG-599/U	EAR99	PEW28TW1003	\$447.50	\$425.13	\$402.75	\$384.85	27	
			90		Square Cover UG-599/U	EAR99	PEW28TW1001	\$368.60	\$350.17	\$331.74	\$317.00	28	
WR-42	18 - 26.5	1.25:1	45 Left-hand	3	Square Cover UG-595/U	EAR99	PEW42TW1002	\$435.95	\$414.15	\$392.36	\$374.92	29	
			45 Right-hand		Square Cover UG-595/U	EAR99	PEW42TW1003	\$435.95	\$414.15	\$392.36	\$374.92	30	
		1.07:1	90		Square Cover UG-595/U	EAR99	PEW42TW1001	\$413.38	\$392.71	\$372.04	\$355.51	31	
WR-8	90 - 140		45 Left-hand	1	Square Cover UG-387/U-Mod	EAR99	PEW8TW0001	\$499.00	\$474.05	\$449.10	\$429.14	32	
			90 Right-hand		Round Cover UG-387/U-Mod	EAR99	PEW8TW0002	\$499.00	\$474.05	\$449.10	\$429.14	33	
WR-6	110 - 170		45 Right-hand	1	Square Cover UG-387/U-Mod	EAR99	PEW6TW0000	\$499.00	\$474.05	\$449.10	\$429.14	34	
			45 Left-hand		Square Cover UG-387/U-Mod	EAR99	PEW6TW0001	\$499.00	\$474.05	\$449.10	\$429.14	35	
			90 Right-hand		Round Cover UG-387/U-Mod	EAR99	PEW6TW0002	\$499.00	\$474.05	\$449.10	\$429.14	36	
WR-5	140 - 220		45 Right-hand	1	Square Cover UG-387/U-Mod	EAR99	PEW5TW0000	\$529.00	\$502.55	\$476.10	\$454.94	37	
			45 Left-hand		Square Cover UG-387/U-Mod	EAR99	PEW5TW0001	\$529.00	\$502.55	\$476.10	\$454.94	38	
			90 Right-hand		Round Cover UG-387/U-Mod	EAR99	PEW5TW0002	\$529.00	\$502.55	\$476.10	\$454.94	39	

WAVEGUIDE VARIABLE ATTENUATORS



Waveguide Type	RF Frequency (GHz.)	Flange Type	IL (dB)	Max Atten. (dB)	ECCN	Model No	1	2-4	5-9	10+	ROW
WR-10	75 - 110	Round Cover UG-387/U-Mod	1	30	EAR99	PEW10AT002-30	\$1,859.97	\$1,785.57	\$1,711.17	\$1,636.77	40
WR-15	50 - 75	Round Cover UG-385/U	0.8		EAR99	PEW15AT001-30	\$1,923.04	\$1,846.12	\$1,769.20	\$1,692.28	41
WR-19	40 - 60	Round Cover UG-383/U-Mod	0.6		EAR99	PEW19AT001-30	\$1,877.30	\$1,802.21	\$1,727.12	\$1,652.02	42
WR-22	33 - 50	Round Cover UG-383/U	0.5		EAR99	PEW22AT001-30	\$1,840.48	\$1,776.06	\$1,711.65	\$1,656.43	43

WAVEGUIDE ACCESSORIES



Waveguide Type	Description	Model No	1-9	10-24	25-49	50+	ROW
WR-10	WR-10 Waveguide Shim, UG-Cover Round flange, 2mm Brass	PEW10FS2	\$95.00	\$90.25	\$85.50	\$81.70	44
	WR-10 Waveguide Short Plate, UG-Cover Round Flange, 4mm Copper	PEW10SP4	\$95.00	\$90.25	\$85.50	\$81.70	45
WR-12	WR-12 Waveguide Shim, UG-Cover Round flange, 2mm Brass	PEW12FS2	\$95.00	\$90.25	\$85.50	\$81.70	46
	WR-12 Waveguide Short Plate, UG-Cover Round Flange, 4mm Copper	PEW12SP4	\$95.00	\$90.25	\$85.50	\$81.70	47
WR-15	WR-15 Waveguide Shim, UG-Cover Round flange, 2mm Brass	PEW15FS2	\$95.00	\$90.25	\$85.50	\$81.70	48
	WR-15 Waveguide Short Plate, UG-Cover Round Flange, 4mm Copper	PEW15SP4	\$95.00	\$90.25	\$85.50	\$81.70	49
WR-19	WR-19 Waveguide Shim, UG-Cover Round flange, 3mm Brass	PEW19FS3	\$95.00	\$90.25	\$85.50	\$81.70	50

WAVEGUIDE ACCESSORIES



Waveguide Type	Description	Model No	1 Pc. Price	See Web for Volume Pricing	R O W
WR-19	WR-19 Waveguide Short Plate, UG-Cover Round Flange, 4mm Copper	PEW19SP4	\$95.00	See Web for Volume Pricing	51
WR-22	WR-22 Waveguide Shim, UG-Cover Round flange, 3mm Brass	PEW22FS3	\$95.00		52
	WR-22 Waveguide Short Plate, UG-Cover Round Flange, 4mm Copper	PEW22SP4	\$95.00		53
WR-28	WR-28 Waveguide Electrically Conductive Gasket kit Square Cover, Choke Flange	PEWKG1014	\$106.00		54
	WR-28 Waveguide Gasket kit Square Cover, Choke Flange, Non-Conductive	PEWKG1000	\$44.12		55
	WR-28 Waveguide Shim, UG-Cover Square flange, 3mm Brass	PEW28FS3	\$126.67		56
WR-34	WR-28 Waveguide Short Plate, UG-Cover Square Flange, 5mm Copper	PEW28SP4	\$126.67		57
	WR-34 Waveguide Shim, UG-Cover Square flange, 4mm Brass	PEW34FS4	Call		58
WR-42	WR-34 Waveguide Short Plate, UG-Cover Square Flange, 4mm Copper	PEW34SP4	\$126.67		59
	WR-42 Waveguide Shim, UG-Cover Square flange, 4mm Brass	PEW42FS4	\$126.67		60
	WR-42 Waveguide Short Plate, UG-Cover Square Flange, 4mm Copper	PEW42SP4	\$126.67		61
WR-51	WR-42, WR-34 Waveguide Electrically Conductive Gasket kit Square Cover, Choke Flange	PEWKG1015	\$122.17		62
	WR-42, WR-34 Waveguide Gasket kit Square Cover, Choke Flange, Non-Conductive	PEWKG1001	\$42.70		63
	WR-51 Waveguide Electrically Conductive Gasket kit Square Cover, Choke Flange	PEWKG1016	\$134.36		64
WR-62	WR-51 Waveguide Gasket kit Square Cover, Choke Flange, Non-Conductive	PEWKG1002	\$43.66		65
	WR-62 Waveguide Electrically Conductive Gasket kit Square Cover, Choke Flange	PEWKG1017	\$196.36		66
	WR-62 Waveguide Gasket kit Square Cover, Choke Flange, Non-Conductive	PEWKG1003	\$48.77		67
WR-75	WR-62 Waveguide Shim, UG-Cover Square flange, 5mm Brass	PEW62FS5	\$63.33		68
	WR-62 Waveguide Short Plate, UG-Cover Square Flange, 5mm Copper	PEW62SP5	\$79.17		69
	WR-75 Waveguide Electrically Conductive Gasket kit Square Cover, Choke Flange	PEWKG1018	\$121.91		70
WR-90	WR-75 Waveguide Gasket kit Square Cover, Choke Flange, Non-Conductive	PEWKG1004	\$48.77		71
	WR-75 Waveguide Shim, UG-Cover Square flange, 5mm Brass	PEW75FS5	\$66.50		72
	WR-75 Waveguide Short Plate, UG-Cover Square Flange, 5mm Copper	PEW75SP5	\$79.17		73
WR-90	WR-90 Waveguide Electrically Conductive Gasket kit Square Cover, Choke Flange	PEWKG1019	\$170.93		74
	WR-90 Waveguide Electrically Conductive Gasket kit, CPR Flat Flange	PEWKG1021	\$125.85		75
	WR-90 Waveguide Electrically Conductive Gasket kit, CPR Grooved Flange	PEWKG1020	\$145.30		76
	WR-90 Waveguide Gasket kit Square Cover, Choke Flange, Non-Conductive	PEWKG1005	\$52.45		77
	WR-90 Waveguide Gasket kit, CPR90 Flat Flange, Non-Conductive	PEWKG1007	\$59.12		78
	WR-90 Waveguide Gasket kit, CPR90 Grooved Flange, Non-Conductive	PEWKG1006	\$59.12		79
	WR-90 Waveguide Shim, UG-Cover Square flange, 5mm Brass	PEW90FS5	\$66.50		80
WR-112	WR-90 Waveguide Short Plate, UG-Cover Square Flange, 5mm Brass	PEW90SP5	\$79.17		81
	WR-112 Waveguide Electrically Conductive Gasket kit Square Cover, Choke Flange	PEWKG1022	\$148.43		82
	WR-112 Waveguide Electrically Conductive Gasket kit, CPR Flat Flange	PEWKG1024	\$133.90		83
	WR-112 Waveguide Electrically Conductive Gasket kit, CPR Grooved Flange	PEWKG1023	\$185.94		84
	WR-112 Waveguide Gasket kit Square Cover, Choke Flange, Non-Conductive	PEWKG1008	\$52.45		85
	WR-112 Waveguide Gasket kit, CPR112 Flat Flange, Non-Conductive	PEWKG1010	\$60.90		86
	WR-112 Waveguide Gasket kit, CPR112 Grooved Flange, Non-Conductive	PEWKG1009	\$60.90		87
WR-137	WR-112 Waveguide Shim, UG-Cover Square flange, 5mm Brass	PEW112FS5	\$79.17		88
	WR-112 Waveguide Short Plate, UG-Cover Square Flange, 5mm Copper	PEW112SP5	\$79.17		89
	WR-137 Waveguide Electrically Conductive Gasket kit, CPR Grooved Flange	PEWKG1026	\$174.57		90
	WR-137 Waveguide Electrically Conductive Gasket kit, CPR Grooved Flange	PEWKG1027	\$148.43		91
	WR-137 Waveguide Electrically Conductive Gasket kit, Round Cover, Choke Flange	PEWKG1025	\$294.09		92
	WR-137 Waveguide Gasket kit Round Cover, Choke Flange, Non-Conductive	PEWKG1011	\$54.61		93
	WR-137 Waveguide Gasket kit, CPR137 Flat Flange, Non-Conductive	PEWKG1013	\$62.80		94
WR-159	WR-137 Waveguide Gasket kit, CPR137 Grooved Flange, Non-Conductive	PEWKG1012	\$62.80		95
	WR-137 Waveguide Shim, CPR-137F flange, 7mm Brass	PEW137FS7	\$101.33		96
	WR-137 Waveguide Short Plate, CPR-137F Flange, 7mm Copper	PEW137SP7	\$95.00		97
WR-187	WR-159 Waveguide Shim, CPR-159F flange, 7mm Aluminum	PEW159FS7	\$79.17		98
	WR-159 Waveguide Short Plate, CPR-159F Flange, 7mm Aluminum	PEW159SP7	\$79.17		99
WR-284	WR-187 Waveguide Shim, CPR-187F flange, 7mm Aluminum	PEW187FS7	\$79.17		1
	WR-187 Waveguide Short Plate, CPR-187F Flange, 7mm Aluminum	PEW187SP7	\$79.17		2
WR-340	WR-284 Waveguide Shim, CPR-284F flange, 8mm Aluminum	PEW284FS8	\$95.00		3
	WR-284 Waveguide Short Plate, CPR-284F Flange, 8mm Aluminum	PEW284SP8	\$95.00		4
WR-430	WR-340 Waveguide Shim, CPR-340F flange, 10mm Aluminum	PEW340FS10	\$114.00		5
	WR-340 Waveguide Short Plate, CPR-340F Flange, 10mm Aluminum	PEW340SP10	\$142.50		6
WR-430	WR-430 Waveguide Shim, CPR-430F flange, 10mm Aluminum	PEW430FS10	\$114.00		7
	WR-430 Waveguide Short Plate, CPR-430F Flange, 10mm Aluminum	PEW430SP10	\$140.00		8
	4-40 with 3/32 inch Hex, Stainless Steel Waveguide Flange Screw	PEWGHW9000	\$4.46		9
	Waveguide Table Jack, Large	PEWGHW1001	\$342.85		10
	Waveguide Table Jack, Medium	PEWGHW1000	\$296.86		11

See Our Website For Current Pricing & Real-Time Stock Availability!

Waveguides

INDEX GUIDE TO APPENDIX

APPENDIX.....	350
<i>PASTERNAK REACH PROGRAM.....</i>	<i>351</i>
<i>PASTERNAK RoHS PROGRAM.....</i>	<i>351</i>
<i>MAILING LIST CHANGES.....</i>	<i>352</i>
<i>BINDING TERMS.....</i>	<i>352</i>
<i>PE PART # INDEX.....</i>	<i>355</i>
<i>CONVERSION TABLES.....</i>	<i>367</i>
<i>MOUNTING HOLES.....</i>	<i>369</i>
<i>CONNECTOR IDENTIFIER.....</i>	<i>370</i>
<i>CONNECTOR FREQUENCY RANGE CHART.....</i>	<i>374</i>

PASTERNAK ENTERPRISES -- REACH PRODUCT COMPLIANCE PROGRAM

OUR COMMITMENT

At Infinite Electronics, we maintain a comprehensive REACH compliance program to help customers with their green aspirations. We strive to have accurate and available material content data on all of our products. When data is not yet available, customer requests will be given top priority.

WHAT IS REACH?

Regulation (EC) No. 1907/2006 of the European Parliament and of the Council of 18 December 2006 is commonly referred to as REACH (Registration, Evaluation, Authorization, and Restriction of Chemicals). The REACH regulation became effective on June 1, 2007 with the objective to improve protection of human health and the environment from exposure to chemicals. Under REACH, there is an obligation to ensure that articles do not contain any of the substances on the REACH Substances of Very High Concern (SVHCs) Candidate list in concentrations greater than 0.1% by weight. SVHCs are substances that may cause cancer or other serious health or environmental effects and thus face potential restriction or outright bans. The SVHC list is updated with additional substances at approximately every six months, thus product declarations must indicate the applicable SVHC release date.

OUR APPROACH

Infinite Electronics has partnered with Assent Compliance, a world class provider of compliance software and professional support staff, to obtain current material content data on our vast selection of electronic products. Together, we work with our supply chain to routinely collect and analyze this data which enables us to determine the state of compliance for each item we sell. As part of our process integration efforts, we are currently redesigning the way this data can be found on-line so that it is consistent across all brands. Once deployed, we will have a customer self-serve search engine tool to enable real-time creation of part number specific declarations. Until then, customers may request declarations directly from our Assent Compliance partners at InfiniteElectronicsRequests@assentcompliance.com. Please ensure you that you list all Infinite Electronics part numbers within your request.

PASTERNAK ENTERPRISES ROHS COMPLIANCE PROGRAM

OUR COMMITMENT

At Infinite Electronics, we maintain a comprehensive RoHS compliance program to help customers with their green aspirations. We strive to have accurate and available material content data on all of our products. When data is not yet available, customer requests will be given top priority.

WHAT IS ROHS?

Short for Directive on the restriction of the use of certain hazardous substances in electrical and electronic equipment, RoHS was adopted in February 2003 by the European Union. Now in its third iteration as (EU) Directive 2015/863, RoHS guidelines and legislation are intended to reduce the presence of ten (10) materials deemed hazardous to the environment. To comply, products entering the EU must not have a homogeneous presence of these materials above the following levels by percentage of their weight:

- Lead (Pb) < 0.1%
- Mercury (Hg) < 0.1%
- Cadmium (Cd) < 0.01%
- DEHP < 0.1%
- DBP < 0.1%
- Hexavalent Chromium (CrVI) < 0.1%
- Polybrominated Biphenyls (PBB) < 0.1%
- Polybrominated Diphenyl Esters (PBDE) < 0.1%
- BBP < 0.1%
- DIBP < 0.1%

OUR APPROACH

Infinite Electronics has partnered with Assent Compliance, a world class provider of compliance software and professional support staff, to obtain current material content data on our vast selection of electronic products. Together, we work with our supply chain to routinely collect and analyze this data which enables us to determine the state of compliance for each item we sell. As part of our process integration efforts, we are currently redesigning the way this data can be found on-line so that it is consistent across all brands. Once deployed, we will have a customer self-serve search engine tool to enable real-time creation of part number specific declarations. Until then, customers may request declarations directly from our Assent Compliance partners at InfiniteElectronicsRequests@assentcompliance.com. Please ensure you that you list all Infinite Electronics part numbers within your request.

MAILING LIST CHANGES

If you receive more than one RF Product Guide with the same name and address, please notify Pasternack and pass the RF Product Guide along to a friend. Also, if you do not require multiple copies to the same company address, contact a sales representative to verify and modify your mailing information. A forms-based communications method to add, delete or modify mailing information is available at www.pasternack.com. By clicking "Contact Us", and then clicking "Remove Name from Mailing List", you may complete the form to request a change to your mailing preferences. In addition, by clicking "RF Product Guide", and then clicking "Request a Printed RF Product Guide", you may add your contact information to our mailing list. Please note service opt-in and opt-out options located on the forms. Alternatively, you may mail, email, telephone or fax Pasternack your request.

PLACING YOUR ORDER

► BY TELEPHONE: 866-PASTERNAK (866-727-8376) US & CANADA, OR 949-261-1920

Our friendly sales representatives are ready to serve you from 5:00am to 5:30pm Pacific Standard Time (PST), Monday through Friday. For the most efficient service, please have ready a list of quantities and part numbers and, if paying by credit card, your MasterCard, VISA, American Express or Discover card. Note: Calls may be recorded or monitored for quality and training purposes.

► BY FAX: 949-261-7451

Our fax lines can be accessed 7 days a week, 24 hours a day. Orders received after 4:00pm PST will be promptly processed and shipped the next business day. Please include your daytime phone number and/or email address in case we have any questions about your order.

► BY INTERNET: WWW.PASTERNAK.COM OR EMAIL: SALES@PASTERNAK.COM

Order online 7 days a week, 24 hours a day using our online ordering system. Just search for the items you want and add them to your shopping cart. Internet orders entered after 4:00 pm PST will be promptly processed and shipped the next business day.

► BY MAIL: SIMPLY MAIL YOUR ORDER TO: PASTERNAK ENTERPRISES.

17802 FITCH
PO BOX 16759
IRVINE, CA 92623-6759 USA

International customers, please see "International Orders" below for additional information.

TERMS AND CONDITIONS OF SALE:

The following from Pasternack's Binding Terms and Conditions of Sale are provided for your convenience. A complete documentation of the Binding Terms and Conditions of Sale may be found in the back of the RF Product Guide, or on Pasternack's website at <https://www.pasternack.com/t/terms-of-sale.aspx>. Any questions or clarifications may be answered by contacting Customer Service at (+1) 949-261-1920 or by any of the methods listed above.

NO MINIMUM ORDER REQUIREMENT

GROUND FREIGHT:

Shipping or freight charges and insurance will be paid by the customer. All sales are made FCA-Shipping Point (as defined by the INCOTERMS 2000) in Irvine, CA USA & Lewisville, TX USA. Shipping or freight charges from Pasternack's Irvine, CA factory are prepaid and added to the invoice or billed collect.

SAME-DAY SHIPMENT:

Same-day shipment will apply to orders received Monday through Friday, prior to 4:00pm PST.

- All UPS air and surface options
- All FedEx air options (with an approved account number)
- Most other shipping options, including DHL (with an approved account number) and USPS

COUNTER-TO-COUNTER SHIPPING:

For your urgent order requiring our fastest shipping method, we will place your order on the next available flight from Santa Ana-Orange County John Wayne International Airport (Airport code: SNA) and Dallas/Fort Worth International Airport (Airport Code: DFW) to the destination you specify. Please call for details.

PAYMENT TERMS:

Pasternack offers a number of convenient payment methods:

For United States customers, we offer check, money order, MasterCard, VISA, American Express, and Discover, as well as open account credit to qualified institutions and businesses. Payment must be made in US Dollars.

For Canadian customers, we offer all of the above payment options.

For International customers, see International Orders.

OPEN ACCOUNT CREDIT:

Net 30 Days terms are available to businesses, schools and agencies subject to credit approval. Approval can begin by submitting a completed Credit Application, which can be found online at: www.Pasternack.com/t-CreditApplication.aspx

EFT/WIRE TRANSFERS:

Please contact us for details. We will inform you of the total amount which will include shipping charges and any applicable wire transfer fees. Orders will not be accepted until funds have been received in full.

WELLS FARGO BANK
420 MONTGOMERY ST.
SAN FRANCISCO, CA 94104 USA
ACCOUNT NUMBER: 4270 0000 0000 0000 1
ROUTING NUMBER: 121000248
SWIFT NUMBER: WFBUS6S

INTERNATIONAL ORDERS:

In addition to the United States and its territories, Pasternack accepts international orders. All orders of international origin are exported from the US in accordance with the Export Administration Regulations. Diversion contrary to US Law is prohibited. Please see Pasternack's Binding Terms and Conditions of Sale for full details.

Pasternack has international distributors for the following countries:

Africa: Namibia, South Africa

Asia-Pacific: Australia, China PRC, India, Indonesia, Japan, Malaysia, New Zealand, Singapore, South Korea, Thailand

Europe: Austria, Belgium, Czech Republic, Denmark, Finland, France, Germany, Ireland, Italy, Kazakhstan, Luxembourg, Netherlands, Norway, Poland, Portugal, Russia, Slovakia, Spain, Sweden, Switzerland, Turkey, United Kingdom

Middle East: Israel

South America: Brazil

To access their complete contact information, please see our International Distributors section in this RF Product Guide. (inside back cover)

INTERNATIONAL SHIPPING CHARGES:

Shipping or freight charges and insurance will be paid by the customer. All sales are made FCA-Shipping Point (as defined by the INCOTERMS 2000) in Irvine, CA USA. We ship orders by UPS, FedEx (with an approved account number), or DHL (with approved account number) with delivery in 2 to 3 days to most locations worldwide.

INTERNATIONAL TAXES AND DUTIES:

Customer is responsible for duties and taxes.

BINDING TERMS AND CONDITIONS OF SALE

1. SCOPE; CHANGES

The terms and conditions stated herein (this "Agreement") govern all sales of products or services ("products") by Infinite Electronics, Inc. (collectively, "we," "us," "our," or "seller") to you or the entity you represent ("you" or "buyer"). You represent to us that you are lawfully able to enter into contracts (e.g., you are not a minor) and that if you are entering into this Agreement for an entity, such as the company you work for, you represent to us that you have the legal authority to bind that entity. Unless otherwise agreed to in writing by seller's authorized agent, any terms and conditions contained in buyer's purchase order or any other document that are different from or in addition to these terms and conditions are objected to, are rejected, and will not be binding on us. By placing an order for products from us, or by accepting delivery of the products described on the applicable packing slip, bill of lading and/or invoice received with the products, you agree to be bound by and accept these terms and conditions of sale.

We may change the terms and conditions of this Agreement in our sole discretion by posting an updated version of these terms and conditions at this location; provided, however, that the terms and condition of this Agreement in effect as of the date of an applicable order shall continue to govern such order and the products purchased thereunder.

2. ORDER ACCEPTANCE

a) Your receipt of an email or other form of order confirmation does not constitute our acceptance of your order or a confirmation of an offer to sell.

b) We reserve the right, without prior notification, to limit the order quantity on any item and/or refuse service to anyone.

c) All orders are subject to review and acceptance by us. You agree to provide complete and accurate contact information in connection with any order submitted to us. Verification of information may be required prior to the acceptance of any order.

d) In the case of pre-stocked finished goods, order acceptance is designated by fulfilling the order. In the case of products requiring post-order processing (including but not limited to design, material purchase, manufacturing or test), order acceptance is designated by performing activities unique to the order.

3. ORDER CANCELLATION

a) Orders fully or partially processed by seller may not be cancelled by buyer.

b) Products not previously stocked as finished goods are both Non-Cancelable and Non-Refundable ("NC/NR"). NC/NR products include cable assemblies, special orders, custom orders, orders for non-standard products, products not customarily in stock, scheduled orders requiring special procurements, or orders for products requiring assembly or manufacturing activities prior to shipping (not stored in completed state) as well as purchased services such as special testing or product modifications.

c) In the event of cancellation or other withdrawal of an order for any reason and without limiting any other remedy as a result of such cancellation or other withdrawal, reasonable cancellation or restocking charges, which shall include all expenses then incurred and commitments made by seller, shall be paid by buyer. Buyer's requests to reschedule are subject to acceptance by seller in its sole discretion. Orders may not be rescheduled after the order has been submitted by seller to the shipment carrier.

4. PRICES

a) Orders are billed at the prices (in US dollars) in effect at the time of shipment.

b) Prices will be as specified within seller's website or as stated in seller's quote / proposal. If no period is specified, quoted prices will be applicable for thirty (30) days.

c) For catalog products, the website contains the most current catalog pricing and is the price reference for such orders. Pricing included in the catalog is for reference only and final pricing is determined by the published website price.

d) For non-catalog products and services, prices cited are based on current costs and are subject to reasonable adjustment on or after the date of acceptance of any purchase order to meet a rise or fall in such costs, as computed on the date of delivery.

e) Prices are subject to change without notice.

f) Prices are exclusive of taxes, impositions and other charges, including: sales, use, excise, value added and similar taxes or charges imposed by any government authority, international shipping charges, forwarding agent's and broker's fees, bank fees, consular fees, document fees and import duties.

5. TERMS OF PAYMENT

a) All payments must be in US Dollars, or will be converted to US Dollars using seller's standard exchange rate at the time of purchase.

b) MasterCard, VISA, Discover, and American Express credit cards, purchase cards and major bank debit cards are accepted. Payment via net thirty (30) days is available to businesses, schools and agencies or as otherwise specified by seller subject to credit approval.

c) For International Orders, MasterCard, VISA, and American Express credit cards are accepted. Payment via open credit account with Net thirty (30) days may be established for companies having three U.S. references accepted to seller. Prepaid Wire Transfer: You can wire the funds to our bank. We will contact you with the total amount, which will include shipping charges and a \$40 wire transfer fee. Orders will not be accepted until funds have been received in full and the Purchase Order (PO) has been received. Notwithstanding anything to the contrary in this Agreement, seller may add or remove payment options in seller's sole discretion.

d) Buyer acknowledges that seller has the right to reassess buyer's creditworthiness from time to time. To the extent such is in accordance with law, in the event there is a decline in buyer's creditworthiness, seller may, upon thirty (30) days written notice, revise the payment terms between the parties. Upon request, buyer shall provide financial data evidencing the buyer's worth in order for seller to determine the creditworthiness of buyer. Such information shall include, but not be limited to, annual reports, balance sheets, and bank records.

e) If buyer is delinquent in its payment obligations, without prejudice to any other remedies available to it by law or in equity, seller may demand immediate payment and at seller's option (i) suspend all further deliveries to be made under the purchase order or any further performance under any other contract with buyer or buyer's affiliates, in which event buyer shall not be released in any respect from its obligations to seller under the purchase order; (ii) recover all costs of collection including but not limited to reasonable attorneys' fees; (iii) repossess the product for which payment has not been made; (iv) charge interest at 1.5% per month on the past due amount, not to exceed the interest percentage allowed by law; and (vii) reassess the credit worthiness of buyer and change any current payment terms. Any discount from seller's rates, if any, shall cease to apply to the delinquent invoice, buyer shall be invoiced for such differences in cost, and shall immediately pay the resulting invoice.

6. TAXES AND DUTIES

a) Any taxes related to the products purchased are the responsibility of buyer (excluding taxes based on seller's net income), unless buyer presents an exemption certificate acceptable to seller and the applicable taxing authorities. If any exemption certificate presented by buyer is held to be invalid, then buyer will pay seller the amount of the tax and any penalties and interest related thereto.

b) If possible, seller will bill taxes as a separate item on the invoice presented to buyer.

c) Sales tax will be charged on product cost and shipping & handling where applicable and required by law. Any sales tax due that is not collected by the seller is the responsibility of the buyer.

d) International orders may be subject to various taxes and duties in the country of destination, all of which are the responsibility of the buyer. This includes sales, use, excise, value added and similar taxes or charges imposed by any government authority, international shipping charges, forwarding agent's and broker's fees, bank fees, consular fees, document fees and import duties.

7. SHIPPING COSTS

Shipping or freight charges and insurance will be paid by the buyer and added to the invoice or billed collect unless specifically stated in the quote or order confirmation based on seller practices or promotions.

8. DELIVERY AND TITLE

a) Unless otherwise agreed to in writing, all products are shipped Incoterms 2010 - FCA Shipping Point. Subject to seller's right of stoppage in transit, delivery of the products to the carrier will constitute delivery to buyer and title and risk of loss will pass to buyer.

b) Seller will make reasonable efforts to initiate shipment and schedule delivery as close as possible to buyer's requested delivery date(s). Buyer acknowledges that delivery dates provided by seller are estimates only and that seller will not be liable for failure to deliver on such dates.

c) Selection of the carrier and delivery route will be made by seller unless specifically designated by buyer.

d) Seller reserves the right to make deliveries in installments. Delay in delivery of one installment will not entitle buyer to cancel any other installment(s). Delivery of any installment of products within thirty (30) days after the date requested will constitute a timely delivery. Delivery of a quantity that varies from the quantity specified shall not relieve buyer of the obligation to accept delivery and pay for the products delivered.

e) Deliveries shall be made during normal business hours Monday through Friday. One attempt to deliver will be made. Should delivery need to be rescheduled, any additional costs incurred for redelivery and/or storage fees will be charged to the buyer. Seller shall use reasonable efforts to make timely delivery but shall be excused from any delays arising out of causes beyond its reasonable control. Any specific delivery dates that may be stated are approximate.

f) If completion of delivery is prevented through no fault of seller, seller may specify a reasonable alternative place of delivery. Buyer agrees that all costs of storage and transport incurred following an initial attempt at delivery are hereby allocated to and imposed upon buyer, and shall be added by seller to the sale price. Delivery may at any time be withheld by seller pending payment of any sum due from the buyer to seller. Seller will return Product via the incoming method unless an alternative method has been indicated on the purchase order or a change authorized by the buyer representative.

g) Deliveries made outside the 48 contiguous States may be subject to modified terms and conditions as stated within the order quote.

9. LIMITED WARRANTY

a) Products manufactured and/or branded by seller are warranted for a period of one year from time of delivery against defects in workmanship or materials or failure to operate as described in product data sheets under normal use. In some cases, the warranty period may exceed one year where a written warranty description specific to a certain product is stated in a contract or posted on a company website, product catalog or user's manual. Accessories and consumable goods such as batteries, chargers and accessory cables are warranted for four months.

b) Products manufactured by seller in accordance with buyer's instructions or specifications provided by seller are warranted for a period of one year from time of delivery against defects in workmanship or materials only under normal use. In some cases, the warranty period may exceed one year where a written warranty description specific to a certain product is stated in a contract or posted on a company website, product catalog or user's manual.

c) Calibration services are warranted for a period of one year from time of completion against defects in workmanship or materials or failure to operate as described in product data sheets under normal use.

d) The warranties set forth in this Section 9 shall not apply to any defect, failure, or damage arising from or in connection with: (i) improper use, or improper or inadequate maintenance and care; (ii) modifications to or repairs of the products performed by any party other than seller; (iii) combination of the products with any other technology, equipment, hardware, software, or other materials; (iv) use of the products in an environment not meeting the operating specifications for the products; (v) failure to properly transport, prepare, and store the products; (vi) acts of God; or (vii) any normal wear and tear or normal environmental degradation.

e) Products solely distributed by seller without alteration carry the warranty of the respective manufacturer only.

f) Seller will at seller's option and in seller's sole discretion, repair, replace or refund any products that are returned under warranty, and Seller's repair, replacement, or refunding of the price paid for a product under warranty shall be seller's sole liability, and buyer's sole remedy, for any breach of the warranties in this Section 9.

g) This warranty applies to the original purchaser only and is not transferable.

h) This warranty does not cover damage incurred during shipment which is the responsibility of the freight shipping company.

i) Buyer will bear the costs of access, de-installation, re-installation and transportation of the products to seller and back to buyer in connection with any warranty claims. Seller will reimburse the costs of transportation to seller and bear the costs of returning the repaired product or sending replacement product to buyer if the product is found to be covered under warranty.

j) Any repair or replacement pursuant to this limited warranty for products manufactured and/or branded by seller shall be warranted against the same defects re-occurring in a period of 12 months from time of delivery of the repaired or replaced product, or until the expiration of the original product warranty, which ever shall be the latter.

k) This limited warranty and remedies are expressly conditioned upon: (i) buyer's payment of the purchase price in full, (ii) buyer giving written notice of the defect, reasonably described, to seller within ten (10) days of the time when buyer discovers or ought to have discovered the defect, (iii) the storage, installation, operation, use, and maintenance of the products in compliance with product instructions, (iv) the existence of proper records of buyer's operation and maintenance of the products during the warranty period, (v) buyer providing seller with a reasonable opportunity to examine the products and the aforementioned records, and (vi) the absence of any unauthorized modification or repair of the products, including without limitation the removal or alternation of any serial numbers or product identifications.

l) THIS WARRANTY IS IN LIEU OF ANY AND ALL OTHER WARRANTIES, WHETHER ORAL, WRITTEN, EXPRESSED, IMPLIED OR STATUTORY. ANY IMPLIED WARRANTIES OF MERCHANTABILITY, FITNESS FOR A PARTICULAR PURPOSE AND NON-INFRINGEMENT ARE HEREBY DISCLAIMED.

10. RETURNS

a) Buyers wishing to return products must first obtain a Return Material Authorization (RMA) number from a Customer Service representative. Unauthorized returns will not be accepted at point of receipt. The RMA number must be printed on the outside of the package in order for it to be received and processed. Merchandise must be shipped prepaid.

b) Seller will determine in seller's sole discretion the appropriate remedies for returned items based on the product's limited warranty and circumstances of the return including a possible refund of purchase price, credit for future purchase, replacement, repair, return to buyer as-is, scrap with consent, and refund of shipping expenses.

c) Items stocked as finished goods and ordered in error must have a Return Material Authorization (RMA) number issued within 30 days of the original order. These parts are eligible for full credit only if the returned products and packaging are in mint and salable condition. A repackaging/restocking charge not to exceed 25% of the sale price may be charged on any products not returned unopened. Under no circumstances will credit be issued after 30 days from date of invoice or for orders exceeding \$500.00 in total value. All freight charges are the responsibility of buyer.

d) Products not previously stocked as finished goods are not returnable unless found to be defective. These include cable assemblies, special orders, custom orders, orders for non-standard products, products requiring assembly or manufacturing activities prior to shipping (not stored in completed state).

e) Defective items must have a Return Material Authorization (RMA) number marked on the package prior to shipping.

f) After 30 days from invoice all merchandise returns for distributed products not manufactured by seller must be handled directly with that manufacturer in accordance with their warranty.

11. ORDER DISCREPANCIES

Claims for shortages, incorrect materials or invoicing errors must be made by buyer in writing within ten (10) business days after receipt of shipment. Claims for nonreceipt of shipment must be made in writing within ten (10) business days after receipt of invoice. No products shall be returned without seller's express instructions. Buyer must provide in writing the order number and describe all defects associated with the order.

12. LIMITATION OF LIABILITIES; INDEMNITY

a) IN NO EVENT WILL SELLER BE LIABLE TO BUYER OR TO ANY THIRD PARTY FOR ANY DELAY, FAILURE TO GIVE NOTICE OF DELAY, LOSS OF USE, SECURITY OR DATA BREACH, LOSS OF REVENUE OR PROFIT OR LOSS OF DATA, RECALL COSTS, SERVICE INTERRUPTIONS, DOWNTIME, TESTING, INSTALLATION, REPLACEMENT, OR REMOVAL COSTS, OR FOR ANY CONSEQUENTIAL, INCIDENTAL, INDIRECT, EXEMPLARY, SPECIAL OR PUNITIVE DAMAGES, WHETHER ARISING OUT OF BREACH OF CONTRACT, TORT (INCLUDING NEGLIGENCE), OR OTHERWISE, REGARDLESS OF WHETHER SUCH DAMAGE WAS FORESEEABLE AND WHETHER OR NOT SELLER HAS BEEN ADVISED OF

THE POSSIBILITY OF SUCH DAMAGES. SELLER'S AGGREGATE LIABILITY FOR ANY CLAIMS ARISING OUT OF OR IN CONNECTION WITH THIS AGREEMENT SHALL NOT EXCEED THE PURCHASE PRICE PAID BY BUYER FOR THE PRODUCTS WHICH ARE THE SUBJECT OF THE CLAIM. THE DISCLAIMERS AND LIMITATIONS IN THIS SECTION 12 WILL APPLY NOTWITHSTANDING ANY FAILURE OF ESSENTIAL PURPOSE OF ANY LIMITED REMEDY AND TO THE MAXIMUM EXTENT PERMITTED UNDER APPLICABLE LAW.

b) Buyer shall defend seller from and against any claims, actions, proceedings, or suits brought by any third party (i) alleging infringement of intellectual property rights arising out of or in connection with seller's compliance with buyer's drawings, specifications, requirements or instructions or (ii) arising out of or in connection with the products supplied by seller and incorporated into the buyer's products (each a "Claim") and shall indemnify and hold harmless seller from any costs, liabilities, damages, fines, judgments, or expenses (including reasonable attorneys' fees) arising out of or in connection with any Claim.

13. EXPORT COMPLIANCE

a) Items are controlled by the U.S. Government and authorized for export only to the country of ultimate destination for use by the ultimate consignee or end-user(s) identified in the invoice. They may not be resold, transferred, or otherwise disposed of, to any other country or to any person other than the authorized ultimate consignee or end-user(s), either in their original form or after being incorporated into other items, without first obtaining approval from the U.S. Government or as otherwise authorized by U.S. law and regulations. Buyer agrees to comply with all applicable export control laws, restrictions and regulations of the United States and those of the buyer's country, and shall not export, or transfer for the purpose of re-export, any product to any embargoed country or region, including but not limited to Cuba, the Crimean Region of Ukraine, Iran, North Korea, Sudan, and Syria, or to any denied, blocked, or designated person or entity as mentioned in any such United States or EU law or regulation. Buyer represents and warrants that it is not on the Denied Persons, Specially Designated Nationals or Debarred Persons List, as identified by the U.S. Treasury Office of Foreign Asset Control (OFAC) and by the U.S. Department of Commerce, Bureau of Industry and Security (BIS), or any other United States list of prohibited persons; is not owned or controlled by any person that is on one of those lists, or is otherwise prohibited by United States or other law from purchasing the products or services hereunder, and shall notify the seller immediately if buyer's status related to the above changes. Buyer shall be solely responsible to obtain any license to export, re-export or import as may be required. Buyer also agrees that it will not use these products in connection with the proliferation of weapons of mass destruction, including missiles, nuclear, chemical or biological weapons.

b) Seller shall not be liable for delays or refusals by governmental authorities or other authorities to grant licenses or approvals, nor for suspension or revocation thereof, nor for changes in export classification. Buyer must deliver requested information, including requested end-user information, necessary for export licenses to be granted, and necessary for seller to determine if a license or other type of authorization is required.

c) For all custom orders, buyer shall provide seller with export classification information for all buyer property and information (including buyer drawings) delivered to seller in relation to this order. Export classification information includes the applicable export control classification, the country of origin and, for hardware only, the Harmonized Tariff Code. For such custom orders, seller will supply buyer with similar export classification information for products and/or information for which seller has design authority. Buyer and seller will promptly notify the other upon a change in classification information if any occurs prior to delivery.

14. GOVERNING LAW; VENUE

a) All matters arising out of or relating to this agreement, or a breach thereof, are governed by and construed in accordance with the internal laws of the State of California without giving effect to any choice or conflict of law provision or rule (whether of the State of California or any other jurisdiction) that would cause the application of the laws of any jurisdiction other than those of the State of California.

b) Any legal suit, action or proceeding arising out of or relating to this agreement, or a breach thereof, will be instituted in the federal or State courts located in the city of Irvine, California or its closest California venue. Each party irrevocably submits to the exclusive jurisdiction of the courts in any legal suit, action or proceeding.

15. LEGAL NOTICES

Any legal notice sent to seller from buyer, required or permitted hereunder, will be deemed to have been effectively delivered if in writing and served by personal delivery or sent by registered or certified mail with return receipt requested, postage prepaid, to seller at the primary address specified as seller's place of business.

16. INTELLECTUAL PROPERTY

a) Notwithstanding delivery of and the passing of title in any product, nothing in these terms and conditions shall have the effect of granting or transferring to, or vesting in, buyer any intellectual property rights in or to any products.

b) The drawings, text, product depictions, logos, content, product descriptions, and organization and taxonomy of seller's website, catalogue, product guides or other documents and media owned by the seller and of the described content there within are proprietary to the seller and protected by intellectual property laws, including but not limited to United States Copyright law and United States Trademark law. Whether seller owns copyrights in these works or not, their content and the selection, arrangement, coordination and structure of the arranged content there within are the sole property of the seller. Use of the above stated materials does not give anyone the right to modify, reproduce, transmit, publish, publicly display, adapt, or create derivative works or in any way exploit any of the materials without express written permission of the seller.

c) All trademarks referenced in seller's catalog or website or depicted within any seller's documents or digital media, whether registered in United States or other countries, may not be used without permission of the respective trademark owner. This applies to seller owned trademarks as well as those of seller's suppliers.

d) SELLER MAKES NO REPRESENTATION OR WARRANTY THAT THE PRODUCTS (OR BUYER'S USE OR EXPLOITATION THEREOF) WILL NOT INFRINGE ANY INTELLECTUAL PROPERTY RIGHTS.

17. SOFTWARE

a) To the extent that the product or services contain or are software, seller hereby grants to buyer a non-exclusive, non-transferable, personal license to use the software and related documentation. Buyer's use conclusively evidences its acceptance of this license. Title to the software shall at all times remain with seller. Buyer agrees that the software, all enhancements, related documentation, and derivative works are, and will remain the sole property of seller and includes valuable trade secrets. Buyer agrees to treat the software and related documentation as confidential and to not copy, reproduce, sub-license, or otherwise disclose the software and related documentation to third parties. Buyer agrees to not disassemble, decompile, reverse engineer, create derivative works from or otherwise translate, customize, localize, modify, add to, or in any way alter, rent, or loan the software or related documentation unless the operation is specifically authorized by law.

b) Third party product software Licenses are separate end user license agreements ("EULA") and not issued pursuant to the above stated personal license.

c) Buyer agrees to defend, indemnify and hold harmless seller from all damages and third party claims arising from unauthorized use or transfer of the software or firmware.

d) If the software is licensed for use in the performance of a U.S. Government prime contract or subcontract, buyer agrees that consistent with FAR 12.211 and 12.212, commercial computer software, computer software documentation and technical data for commercial items are licensed under seller's standard commercial license.

18. CONFIDENTIAL INFORMATION

Buyer agrees that all confidential information furnished by or obtained from seller in connection with the sale of items hereunder (including product data and manufacturing process data) shall be adequately safeguarded to prevent unauthorized disclosure. Buyer agrees not to (i) disclose any such information to any other person or entity, or (ii) use such information for any purpose, other than performing authorized activities directly related to the governing contract.

19. TOLERANCES

Unless otherwise agreed to in writing by seller, standard tolerances as described on seller's drawings, websites and/or posted catalog datasheets shall apply.

20. PRODUCT LINE CHANGES

Product specifications and availability are subject to change without notice. Seller reserves the right to change specifications or discontinue items at seller's sole discretion for any reason whatsoever including, but not limited to changing market conditions, product discontinuation, component unavailability, manufacturing cost changes and errors in advertisements.

21. FCC PART 15 AND PART 97 NOTICE

For systems operating within the jurisdiction of the United States Federal Communications Commission (FCC), buyer acknowledges that any amplification device it purchases is intended for use only in a transmission system certified under Part 15, Part 97 or other applicable section of the rules and regulations of the FCC, or that a legal exception to this requirement applies.

22. ASSIGNMENT

Buyer shall not assign this Agreement or any order hereunder without the prior written consent of the seller. Any assignment in violation of the foregoing will be void and of no force or effect. Seller may assign this Agreement or any order hereunder in seller's sole discretion and without restriction. This Agreement will be binding upon and inure to the benefit of the parties, their successors, and permitted assigns.

23. RELATIONSHIP

Nothing in this Agreement or any product or service orders shall be construed to place the buyer or seller in the relationship of partners or joint ventures, and the buyer and seller shall have no power to obligate or bind the other in any manner whatsoever.

24. WAIVER

No waiver by seller of any breach of this Agreement by the buyer shall be considered as a waiver of the subsequent breach of the same or any other provision.

25. SEVERABILITY

If any provision or portion of this Agreement shall be adjudged invalid or unenforceable by a court of competent jurisdiction or by operation of any applicable law, that provision or portion of this Agreement shall be deemed omitted and the remaining provisions and portions shall remain in full force and effect.

26. LIENS AND TITLE

a) Buyer hereby grants to seller a security interest in any property owned by the buyer (including buyer's beneficial rights to property leased by seller) in the possession of seller or any of seller's affiliates, at any time, to secure all amounts owed by buyer to seller under this Agreement.

b) In the case of repairs or overhauls performed pursuant to this Agreement, buyer grants seller a perfected security interest in all products retained in possession of seller upon which any repair or overhaul services have been performed by seller. Buyer further acknowledges and agrees that, in addition to the security interest and lien expressly granted by seller to seller, seller shall have a lien on the product retained in possession of seller to the extent otherwise provided by law. Buyer acknowledges that the lien (whether granted by buyer or through the operation of law) for repairs or overhaul shall be for the full value of such work, and shall be superior to any lien or interest in favor of buyer, its parents, affiliates, or subsidiaries, or any other person who has knowledge of this Agreement. To the extent that seller maintains possession of product under repair, buyer agrees that seller is a secured creditor of buyer and has all the rights of a secured creditor.

c) With respect to products sold pursuant to this Agreement, buyer agrees and acknowledges that seller shall retain a security interest in such product, unless and until all payment for such products has been made and all other covenants and agreements of this Agreement have been performed in full. Accordingly, buyer agrees that it will not suffer or permit any lien or encumbrance to be established that affects the title to the product sold by seller pursuant hereto until seller has been paid in full. Buyer agrees that, in the event of buyer's insolvency, or in the event that any petition is filed by or against buyer under Chapter 7 or Chapter 11 of the Bankruptcy Code, seller may, at its discretion, recover all products sold pursuant to this Agreement and/or seek damages or costs under applicable laws.

27. STORAGE FEES

A storage fee will be applied monthly up to the maximum allowed by law on all repaired and overhauled units if delivery is not taken within five (5) days of notification.

28. FORCE MAJEURE

Notwithstanding anything else in this Agreement, no default, delay, or failure to perform on the part of seller will be considered a breach of this Agreement if such default, delay, or failure to perform is shown to be due to causes beyond reasonable control of seller, including, but not limited to, causes such as strikes, lockouts or other labor disputes, riots, civil disturbances, actions or inactions of governmental authorities or suppliers, epidemics, war, embargoes, severe weather, fire, earthquakes, acts of God or the public enemy, nuclear disasters, or default of a common carrier.

29. ENTIRE AGREEMENT; CONSTRUCTION; SURVIVAL

This Agreement sets forth the entire agreement and understanding of the Parties relating to the subject matter herein and supersedes all prior and contemporaneous communications, representations, discussions, and agreements between the Parties with respect to such subject matter. The titles and section headings used in this Agreement are for ease of reference only and shall not be used in the interpretation or construction of this Agreement. No rule of construction resolving any ambiguity in favor of the non-drafting party shall be applied hereto. The word "including", when used herein, is illustrative rather than exclusive and means "including, without limitation." In the event of any termination or expiration of this Agreement, buyer's obligations to pay amounts due hereunder and arising prior to the date of termination or expiration, as well as Sections 9, 12-18, and 21-29 shall survive such termination or expiration.

WARNING:

Products in this catalog can expose you to chemicals including phthalates, which are known to the State of California to cause cancer and birth defects or other reproductive harm. For more information, go to www.P65Warnings.ca.gov. For specific products impacted, please visit www.pasternack.com.

PART NUMBER INDEX

Note: C/R stands for the Column and/or Row location of the specific product on a given page.

Model No.	Page	C/R	Model No.	Page	C/R	Model No.	Page	C/R	Model No.	Page	C/R	Model No.	Page	C/R	Model No.	Page	C/R
CST-400	Web		PE-T1012	305	55	PE-W11S19001	347	90	PE-W11T005-24	342	55	PE1009-100PK	Web		PE1SA1075	52	26
DBLU	Web		PE-T1013	305	47	PE-W11S22001	347	91	PE-W11T005-36	342	56	PE1010	Web		PE1SA1076	343	95
EZ-200-NMH-X	228	46	PE-T2000	306	93	PE-W151W1001	348	17	PE-W62B001	333	64	PE1011	Web		PE1SA1077	343	96
EZ-200-IFRP	255	45	PE-T2001	306	88	PE-W151W1002	348	15	PE-W62B002	333	65	PE1012	Web		PE1SA2000	51	50
EZ-200-TM-X	252	30	PE-T2002	305	75	PE-W151W1003	348	16	PE-W62B003	333	66	PE1013-2	Web		PE1SA2001	51	52
EZ-240-4310M-X	209	8	PE-T2003	305	71	PE-W19A1001	340	41	PE-W62S001-12	345	97	PE1400	286	29	PE1SA2002	51	53
EZ-240-NMH-RA-X	228	47	PE-T2004	306	96	PE-W19A1501	340	41	PE-W62S001-36	345	97	PE1401	286	31	PE1SA2003	51	51
EZ-240-OMH-RA-X	233	18	PE-T2005	305	64	PE-W19B001	342	54	PE-W62S001-3	345	93	PE1402	286	30	PE1SA2004	51	54
EZ-240-SMH-RA-X	231	82	PE-T2006	305	68	PE-W19C001	342	55	PE-W62S001-6	345	93	PE1403	286	30	PE1SA2005	51	54
EZ-240-SM-X	236	31	PE-T2007	306	79	PE-W19CA001	329	63	PE-W62S001-9	345	96	PE1513	50	25	PE1SA3004	48	9
EZ-240-TM-X	252	31	PE-T2008	306	85	PE-W19CA002	329	64	PE-W62S002-12	345	92	PE1514	50	23	PE1SA3005	48	9
EZ-400-716M-RA-X	210	51	PE-T2009	305	61	PE-W19CP001-10	334	27	PE-W62S002-6	345	90	PE1516	50	20	PE1SA3007	48	8
EZ-400-716M-X	210	36	PE-T2010	305	76	PE-W19CP001-20	334	26	PE-W62S002-9	345	91	PE1517	50	27	PE1SA3008	48	19
EZ-400-BM-X	214	88	PE-T2011	306	2	PE-W19CP003-10	334	24	PE-W62S005-12	341	18	PE1518	50	28	PE1SA3009	48	35
EZ-400-FM-75	259	76	PE-T2012	305	72	PE-W19CP003-20	334	25	PE-W62S005-24	341	19	PE1519	50	34	PE1SA3014	48	14
EZ-400-NF-BH	231	66	PE-T2013	305	62	PE-W19PS1001	343	33	PE-W62S005-36	341	20	PE1520	50	35	PE1SA3015	48	15
EZ-400-NMC-2-D	228	39	PE-T2014	305	65	PE-W19S001-12	345	63	PE-W62T005-12	342	57	PE1521	50	36	PE1SA3016	48	29
EZ-400-NMC-75-X	262	21	PE-T2015	306	89	PE-W19S001-3	345	63	PE-W62T005-24	342	58	PE1522	50	38	PE1SA3017	48	44
EZ-400-NMH-PL-X	228	48	PE-T2017	306	1	PE-W19S001-6	345	64	PE-W62T005-36	342	59	PE1523	50	41	PE1SA3018	48	42
EZ-400-NMH-RA-X	229	85	PE-T2018	306	86	PE-W19S001-9	345	65	PE-W72ANS010-6	324	26	PE1524	50	37	PE1SA3019	48	43
EZ-400-NMH-X	228	49	PE-T2019	306	87	PE-W19T1001	346	37	PE-W75B001	333	68	PE1525	50	31	PE1SA3020	48	45
EZ-400-TM-X	252	32	PE-T2020	306	81	PE-W19T52001	347	92	PE-W75B002	333	69	PE1526	50	31	PE1SA3020	48	45
EZ-600-716M-X	210	37	PE-T2021	306	92	PE-W19T52001	347	93	PE-W75S001-12	345	4	PE1528	50	24	PE1SA3021	48	11
EZ-600-NF-BH	231	67	PE-T2022	306	83	PE-W19T52001	347	93	PE-W75S001-36	345	5	PE1603	83	38	PE1SA3021D	48	12
EZ-600-NF-X	230	29	PE-T2023	306	97	PE-W19T52001	347	93	PE-W75T001-3	345	99	PE1604	83	31	PE1SA3022	48	13
EZ-600-NMC-2-D	228	40	PE-T2024	306	84	PE-W19T52001	347	93	PE-W75T005-6	345	2	PE1605	83	34	PE1SA3023	48	7
EZ-600-NMH-RA-X	229	86	PE-T2025	306	82	PE-W19T52001	347	93	PE-W75S001-9	345	3	PE1606A	83	21	PE1SA3024	48	47
EZ-600-NMH-X	228	50	PE-W10A002-30	348	40	PE-W229AN001/	324	67	PE-W75S001-6	345	98	PE1608	83	23	PE1SA3025	48	49
EZ-600-TM-X	252	33	PE-W10A001	340	38	PE-W229AN001/	324	67	PE-W75S001-12	341	21	PE1610	83	20	PE1SA3026	48	5
EZ-SW396-716MC	209	31	PE-W10C001	329	57	PE-W22A001	340	42	PE-W75S001-36	341	23	PE1611	83	24	PE1SA3037	50	10
EZ-SW396-NMH-RA	229	83	PE-W10C002	329	58	PE-W22A001-30	348	43	PE-W75S001-6	341	21	PE1612	83	25	PE1SA3038	48	36
EZ-SW540-716MC	209	32	PE-W10C003	329	56	PE-W22A001	340	42	PE-W75S001-9	341	22	PE1613	83	26	PE1SA3039	48	37
EZ-SW540-NMC	228	42	PE-W10C004	329	56	PE-W22A002	340	43	PE-W75S001-12	342	62	PE1615	83	28	PE1SA3255	49	63
FT-396	Web		PE-W10CP001-10	334	13	PE-W22B001	332	58	PE-W75S001-36	342	29	PE1616	83	29	PE1SA3256	49	64
LMR-100A-PVC	194	17	PE-W10CP001-20	334	11	PE-W22C001	329	65	PE-W90B001	333	70	PE1617	83	32	PE1SA3257	49	83
LMR-195	194	18	PE-W10CP003-10	334	14	PE-W22C002	329	66	PE-W90B002	333	71	PE1618	83	33	PE1SA3258	49	84
LMR-195-LPL	194	19	PE-W10CP003-20	334	12	PE-W22C002	329	66	PE-W90B003A	333	72	PE1619	83	18	PE1SA3259	49	92
LMR-195-IFR	194	19	PE-W10PS1001-12	343	31	PE-W22C003-10	343	30	PE-W90S001-12	346	14	PE1620	83	19	PE1SA3260	49	97
LMR-200	194	20	PE-W10T1001	346	33	PE-W22PS1001	343	34	PE-W90S001-6	344	10	PE1621	83	20	PE1SA3022	48	32
LMR-200-2F	194	21	PE-W10T1S1001A	347	86	PE-W22PS1001	343	34	PE-W90S001-9	344	12	PE1622	83	36	PE1SA3262	48	22
LMR-200-UF	194	22	PE-W10T1S15001	347	87	PE-W22S001-12	345	72	PE-W90S001-9	344	12	PE1S11001	300	2	PE1SA3263	48	20
LMR-240	194	23	PE-W10T1S19001	347	88	PE-W22S001-3	345	69	PE-W90S001A-9	345	5	PE1S12000	300	1	PE1SA3264	48	21
LMR-240-DB	194	24	PE-W10T1W1001	348	10	PE-W22S001-6	345	70	PE-W90S002-12	346	15	PE1S13900	300	4	PE1SA3265	48	31
LMR-240-UF	194	25	PE-W10T1W1002	348	8	PE-W22S001-12	345	71	PE-W90S002-3	346	7	PE1S13901	300	3	PE1SA3266	49	4
LMR-240-UF	194	26	PE-W112B001	333	73	PE-W22S001-36	345	71	PE-W90S002-6	346	13	PE1S13902	300	5	PE1SA3267	49	65
LMR-400-DB	195	27	PE-W112B002	333	74	PE-W22S005-12	341	3	PE-W90S002-12	346	14	PE1S13903	300	6	PE1SA3268	49	66
LMR-400-UF	195	28	PE-W112S001-3	346	16	PE-W22T005-12	342	43	PE-W90S005-12	341	24	PE1S13904	300	7	PE1SA3269	49	60
LMR-500	195	29	PE-W112S001-6	346	19	PE-W22T005-24	342	42	PE-W90S005-24	341	28	PE1S13905	300	8	PE1SA3270	49	86
LMR-500-DB	195	30	PE-W112S001-9	346	20	PE-W22T005-36	342	42	PE-W90S005-36	341	29	PE1D21000	334	4	PE1SA3271	49	85
LMR-600	195	31	PE-W112S005-12	346	21	PE-W22T1002	346	38	PE-W90S006-24	341	25	PE1D21001	334	3	PE1SA3272	49	61
LMR-600-DB	195	32	PE-W112S005-36	346	21	PE-W22T1002	346	38	PE-W90S006-36	341	27	PE1D21002	333	2	PE1SA3273	49	93
LMR-SW396	195	33	PE-W112S005-6	346	21	PE-W22T1002	346	38	PE-W90T005-12	341	24	PE1D21003	333	1	PE1SA3274	49	95
LMR-SW540	195	34	PE-W112S005-12	346	21	PE-W22T1001	348	24	PE-W90T005-24	341	24	PE1D21004	333	1	PE1SA3275	49	96
PE-020SR	197	80	PE-W112S005-36	346	21	PE-W22T1002	348	21	PE-W90T005-36	342	66	PE1D21005	333	99	PE1SA3276	49	78
PE-034SR	197	81	PE-W112S006-12	341	30	PE-W22T1003	348	22	PE-W90T006-12	342	63	PE1D21006	334	10	PE1SA3277	49	79
PE-047SR	197	82	PE-W112S006-24	341	32	PE-W28A15001	340	44	PE-W90T006-24	342	65	PE1D21007	334	9	PE1SA3278	49	77
PE-047SR	197	82	PE-W112S006-36	341	34	PE-W28B001	332	59	PE-W90T006-36	342	67	PE1D21008	334	8	PE1SA3279	49	1
PE-047SR	197	83	PE-W112S007-12	342	70	PE-W28B002	332	60	SPF-250	Web		PE1D21009	334	6	PE1SA3280	49	66
PE-12EAC	195	35	PE-W112S007-24	342	72	PE-W28B003	332	61	SPF-500	Web		PE1D21010	334	5	PE1SA3281	49	67
PE-12EAC	195	36	PE-W112S007-36	342	69	PE-W28C002	334	33	ST-396	Web		PE1D21011	334	4	PE1SA3282	49	68
PE-14SFHC	195	37	PE-W112S008-12	342	71	PE-W28C002-10	334	33	TC-100-SM	235	82	PE1D21012	333	1	PE1SA3283	49	69
PE-118SR	197	84	PE-W112S008-24	342	73	PE-W28C003-10	334	32	TC-100-TM	251	7	PE1D21013	333	99	PE1SA3284	49	70
PE-195TC	195	48	PE-W112S008-36	342	73	PE-W28C003-20	334	32	TC-195-NMH-RA-D	228	67	PE1D21014	333	99	PE1SA3285	49	71
PE-151TC	195																

PART NUMBER INDEX

Note: C/R stands for the Column and/or Row location of the specific product on a given page.

Model No.	Page	C/R	Model No.	Page	C/R	Model No.	Page	C/R	Model No.	Page	C/R	Model No.	Page	C/R	Model No.	Page	C/R			
PE15A5053	55	51	PE1V11004	301	33	PE2056A	273	85	PE20DV1065	Web	PE2ACP1071	268	12	PE3015	184	71	PE3245	118	92	
PE15A5053F	55	52	PE1V11005	301	34	PE2056B	273	86	PE20DV1067	Web	PE2ACP1072	268	17	PE3020	109	69	PE3246	113	15	
PE15A5054	54	1	PE1V11006	301	35	PE2058	272	76	PE20DV1068	Web	PE2ACP1073	269	29	PE3023	177	17	PE3249	118	93	
PE15A5054E	54	2	PE1V11007	301	36	PE2059	273	79	PE20DV1069	Web	PE2ACP1074	269	23	PE3025	111	18	PE3271	142	43	
PE15A5055	53	36	PE1V11008	301	37	PE2061	286	11	PE20S0001	286	13	PE2ACP1075	268	13	PE3034	128	83	PE3272	133	10
PE15A5056	53	37	PE1V11009	301	38	PE2062	286	9	PE20S0002	286	15	PE2ACP1076	268	18	PE3038	115	27	PE3273	142	41
PE15A5057	53	40	PE1V11010	301	39	PE2063	284	17	PE20S0003	286	14	PE2ACP1100	270	84	PE3041	189	86	PE3275	142	42
PE15A5058	56	60	PE1V11011	301	40	PE2064	284	19	PE20S0004	286	12	PE2ACP1101	270	89	PE3042	122	9	PE3277	Web	42
PE15A5059	56	60	PE1V11012	301	41	PE2065	284	21	PE20S0005	286	17	PE2ACP1102	270	63	PE3044	111	19	PE3278	142	44
PE15A5060	56	61	PE1V11013	301	42	PE2066	284	20	PE20S0006	286	16	PE2ACP1103	270	75	PE3047	110	83	PE3280	123	19
PE15A5061	53	51	PE1V11014	301	43	PE2067	284	18	PE20S0007	286	18	PE2ACP1104	270	85	PE3050	161	12	PE3282	123	17
PE15A5062	56	67	PE1V11015	301	44	PE2068	284	21	PE20S0008	286	22	PE2ACP1105	270	90	PE3051	151	17	PE3285	123	18
PE15A5063	56	68	PE1V11016	301	45	PE2070	284	27	PE20S0009	286	21	PE2ACP1106	270	93	PE3052	112	36	PE3288	123	21
PE15A5064	56	70	PE1V11017	301	46	PE2074	285	76	PE20S0010	286	20	PE2ACP1107	270	96	PE3056	150	79	PE3290	116	46
PE15A5065	53	38	PE1V11018	301	47	PE2077	284	43	PE20S0011	286	19	PE2ACP1108	270	58	PE3057	183	59	PE3291	143	72
PE15A5066	56	72	PE1V11019	301	48	PE2078	284	42	PE20S0012	286	23	PE2ACP1109	270	80	PE3058	153	82	PE3293	116	47
PE15A5067	56	75	PE1V11020	301	49	PE2080A	285	95	PE20S0013	286	12	PE2ACP1126	270	86	PE3061	116	7	PE3295	116	65
PE15A5068	56	75	PE1V11021	301	50	PE2080	285	83	PE20S0014	286	25	PE2ACP1127	270	98	PE3062	154	74	PE3297	116	48
PE15A5069	56	76	PE1V11022	301	51	PE2081	284	40	PE20S0015	286	26	PE2ACP1112	270	92	PE3067	120	40	PE3299	116	58
PE15A5070	56	77	PE1V11023	301	52	PE2082	284	16	PE20S0016	286	28	PE2ACP1113	271	26	PE3071	126	28	PE3301	Web	58
PE15A5071	56	80	PE1V11024	301	53	PE2083	284	24	PE20S0017	286	27	PE2ACP1120	270	88	PE3074	179	71	PE3302	143	78
PE15A5072	56	81	PE1V11025	301	54	PE2084	284	22	PE20S0019	285	91	PE2ACP1124	268	6	PE3075	109	61	PE3304	116	57
PE15A5073	56	81	PE1V11026	301	55	PE2088	285	95	PE20S0020	285	96	PE2ACP1125	268	7	PE3076	144	97	PE3306	116	59
PE15A5074	53	61	PE1V11027	301	56	PE2089	285	95	PE20S0021	286	9	PE2ACP1126	268	8	PE3078	149	76	PE3307	183	78
PE15A5077	53	52	PE1V12000	302	70	PE2090	285	89	PE20S0022	285	72	PE2ACP1127	268	1	PE3080	131	71	PE3309	116	51
PE15A5079	53	76	PE1V12001	302	71	PE2091	286	5	PE20S0023	286	3	PE2ACP1133	268	5	PE3081	109	64	PE3311	Web	58
PE15A5080	53	77	PE1V12002	302	72	PE2092	285	73	PE20S0024	285	93	PE2ACP1134	268	2	PE3082	109	67	PE3314	116	50
PE15A5081	55	29	PE1V12003	302	73	PE2093	285	88	PE20S0025	285	75	PE2ACP1135	268	3	PE3083	115	26	PE3316	116	52
PE15A5082	55	27	PE1V12004	302	74	PE2094	285	94	PE2B11000	83	15	PE2ACP1140	272	67	PE3085	117	81	PE3318	143	81
PE15A5083	53	59	PE1V12005	302	75	PE2095	286	92	PE2B11001	83	11	PE2ACP1141	273	81	PE3087	109	49	PE3319	148	33
PE15A5084	56	71	PE1V12006	302	76	PE2099	286	4	PE2B11002	83	12	PE2ACP1142	273	82	PE3088	116	7	PE3320	148	32
PE15A5085	53	58	PE1V12007	302	77	PE2201	220	57	PE2B11003	83	13	PE2ACP1143	273	80	PE3089	155	31	PE3321	143	73
PE15A5090	57	96	PE1V12008	302	78	PE2202	220	66	PE2B11004	83	14	PE2ACP1144	272	72	PE3093	150	98	PE3323	143	70
PE15A6002	50	45	PE1V13000	302	79	PE2203	220	79	PE2B11005	83	16	PE2ACP1145	272	73	PE3094	112	40	PE3325	110	74
PE15A6007	51	47	PE1V13001	302	80	PE2204	220	82	PE2B11006	83	17	PE2ACP1146	272	35	PE3095	115	28	PE3327	Web	99
PE15A6008	51	48	PE1V13002	302	81	PE2205	220	91	PE2CP000	270	74	PE2ACP1147	272	33	PE3097	122	9	PE3333	150	99
PE15A6012	51	49	PE1V13003	302	82	PE2206	220	95	PE2CP001	270	87	PE2ACP1148	272	36	PE3098	117	64	PE3334	Web	56
PE15A6015	51	49	PE1V13004	302	83	PE2207	220	97	PE2CP002	270	87	PE2ACP1149	272	34	PE3100	109	67	PE3335	113	56
PE15A63000	52	19	PE1V13005	303	84	PE2208	220	41	PE2CP003	269	40	PE2ACP1150	272	32	PE3102	116	1	PE3337	142	60
PE15A63001	52	20	PE1V13006	303	85	PE2209	220	61	PE2CP004	220	67	PE2ACP1151	273	88	PE3103	110	3	PE3341	188	66
PE15A63002	52	21	PE1V13007	303	86	PE2210	220	68	PE2CP005	220	60	PE2ACP1152	273	89	PE3104	Web	3	PE3343	113	53
PE15A63003	52	22	PE1V13008	303	87	PE2211	220	83	PE2CP006	272	66	PE2ACP1153	273	90	PE3108	117	88	PE3344	148	42
PE15A63004	52	23	PE1V13009	303	88	PE2212	220	94	PE2CP011	272	70	PE2ACP1154	273	91	PE3109	165	24	PE3345	144	13
PE15A63005	52	24	PE1V13010	303	89	PE2213	269	51	PE2CP017	272	74	PE2ACP1155	273	92	PE3112	Web	7	PE3346	Web	99
PE15A63006	52	25	PE1V13011	303	90	PE2215	220	73	PE2CP019	272	78	PE2ACP1157	273	93	PE3116	110	77	PE3347	Web	99
PE15A63007	52	26	PE1V13012	303	91	PE2216	221	21	PE2CP021	272	81	PE2ACP1158	273	94	PE3117	119	52	PE3348	142	60
PE15A63008	52	29	PE1V13013	303	92	PE2218	221	23	PE2CP023	272	77	PE2ACP1159	273	95	PE3120	113	55	PE3349	171	44
PE15A63009	52	30	PE1V13014	303	93	PE2219	221	24	PE2CP025	269	53	PE2ACP1160	273	96	PE3121	147	82	PE3351	111	21
PE15A63010	52	31	PE1V13015	303	94	PE2220	221	27	PE2CP1000	271	1	PE2ACP1161	273	87	PE3122	Web	74	PE3352	149	57
PE15A63011	52	32	PE1V14000	302	57	PE2221	221	28	PE2CP1001	271	18	PE2CP1001	313	31	PE3123	Web	74	PE3353	146	76
PE15A7000	56	82	PE1V14001	302	58	PE2222	221	29	PE2CP1002	271	2	PE2CP1002	313	33	PE3130	Web	79	PE3355	110	73
PE15A8000	50	29	PE1V14002	302	59	PE2223	221	30	PE2CP1003	271	3	PE2CP1003	313	27	PE3133	Web	77	PE3357	115	31
PE15A8001	50	30	PE1V14003	302	60	PE2224	221	31	PE2CP1004	271	49	PE2CP1004	313	29	PE3134	Web	79	PE3358	115	32
PE15A8004	50	32	PE1V14004	302	61	PE2226	269	31	PE2CP1005	271	4	PE2CP1005	313	30	PE3137	149	54	PE3361	146	79
PE15A8005	50	33	PE1V14005	302	62	PE2227	269	35	PE2CP1006	271	16	PE2CP1006	313	32	PE3138	147	91	PE3362	189	91
PE15A8006	50	39	PE1V14006	302	63	PE2228A	269	32	PE2CP1007	271	5	PE2CP1007	313	26	PE3139	176	75	PE3364	112	41
PE15A8007	50	40	PE1V14007	302	64	PE2230	269	36	PE2CP1008	271	6	PE3141	313	28	PE3141	161	97	PE3365	117	78
PE15A8000	50	44	PE1V14008	302	65	PE2234	269	38	PE2CP1009	271	20	PE3143	301	9	PE3143	126	23	PE3366	112	30
PE15A8001	50	43	PE1V14009	302	66	PE2235	269	37	PE2CP1010	271	8	PE3145	301	10	PE3145	115	18	PE3367	145	27
PE15A8002	50	44	PE1V14010	302	67	PE2236	269	34	PE2CP1011	271	10	PE3147	301	11	PE3147	160	93	PE3368	110	93
PE15A9000	51	79	PE1V15000	303	68	PE2237	269	33	PE2CP1012	271	11	PE3149	301	12	PE3149	161	10	PE3369	145	72
PE15A9001	51	79	PE1V15001	303	69	PE2240	269	24	PE2CP1013	271	12	PE2V004	301	13	PE3152	161	11	PE3370	111	24
PE15B5000	48	3	PE1V13100	303	95	PE2242	269	46	PE2CP1014	271	22	PE2V005	301	14	PE3154	154	14	PE3371	Web	20
PE15B5001	48	2	PE1V13101	303	96	PE2242A	269	47	PE2CP1114-10	Web	Web	PE2V006	301	15	PE3156-12	Web	11	PE3372	111	20
PE15B5003	48	1	PE1V13102	303	97	PE2243	269	50	PE											

PART NUMBER INDEX

Note: C/R stands for the Column and/or Row location of the specific product on a given page.

Model No.	Page	C/R	Model No.	Page	C/R	Model No.	Page	C/R	Model No.	Page	C/R	Model No.	Page	C/R	Model No.	Page	C/R			
PE3468	167	61	PE3479	162	21	PE3494	110	87	PE3476	172	95	PE3438	125	94	PE34281	Web		PE34497	172	80
PE3472	124	63	PE3481	158	23	PE3495	117	79	PE3479	172	2	PE3440	125	95	PE34282	179	50	PE34498	Web	
PE3476	122	10	PE3484	Web		PE3496	Web		PE3481	145	17	PE3441	161	14	PE34283	Web		PE34499	Web	
PE3477	122	14	PE3486	128	87	PE3497	Web		PE3482	125	93	PE3442	125	93	PE34284	Web		PE34500	Web	
PE3479	141	6	PE3489	110	75	PE3498	151	13	PE3483	115	37	PE3443	145	23	PE34285	Web		PE34501	173	15
PE3480	189	3	PE3492-12	Web		PE3499	143	77	PE3484	170	41	PE3444	Web		PE34286	Web		PE34502	Web	
PE3481	146	66	PE3494	117	71	PE3500	148	30	PE3485	175	84	PE3445	Web		PE34287	127	67	PE34503	174	29
PE3483	148	27	PE3496	141	95	PE3501	151	16	PE3486	168	83	PE3446	Web		PE34288	Web		PE34504	Web	
PE3485	125	57	PE3497	150	61	PE3502	156	31	PE3487	175	89	PE3447	165	10	PE34289	Web		PE34505	Web	
PE3487	125	80	PE3498	132	7	PE3503	151	11	PE3488	Web		PE3448	128	79	PE34290	Web		PE34507	Web	
PE3488	128	80	PE3499	126	22	PE3504	152	64	PE3489	141	9	PE3449	Web		PE34291	Web		PE34508	Web	
PE3490	Web		PE3504	147	86	PE3505	152	72	PE3490	124	72	PE3450	Web		PE34292	162	19	PE34509	Web	
PE3492	147	3	PE3506	150	80	PE3506	152	81	PE3491	124	71	PE3451	Web		PE34293	161	6	PE34510	Web	
PE3494	151	14	PE3513	160	83	PE3507	151	32	PE3492	133	33	PE3452	Web		PE34294	161	9	PE34511	174	33
PE3495	109	43	PE3514	127	52	PE3508	Web		PE3493	133	33	PE3453	145	24	PE34295	145	24	PE34512	Web	
PE3496	124	73	PE3515	150	78	PE3509	167	63	PE3494	128	90	PE3454	Web		PE34296	145	25	PE34513	Web	
PE3497	117	5	PE3516	152	57	PE3510	171	61	PE3495	132	89	PE3455	145	25	PE34297	162	20	PE34514	Web	
PE3498	177	12	PE3517	152	54	PE3511	127	68	PE3496	133	32	PE3456	128	39	PE34298	162	20	PE34515	Web	
PE3499	125	1	PE3518	Web		PE3512	131	65	PE3497	177	15	PE3457	133	30	PE34299	161	7	PE34516	Web	
PE3500	147	87	PE3519	126	24	PE3513	128	94	PE3498	116	41	PE3458	133	30	PE34300	161	7	PE34517	116	40
PE3501	Web		PE3520	158	18	PE3514	127	60	PE3499	116	38	PE3459	128	93	PE34301	162	20	PE34518	Web	
PE3502	Web		PE3521	157	70	PE3515	160	82	PE3500	116	31	PE3460	109	55	PE34302	162	20	PE34519	Web	
PE3503	179	42	PE3522	152	69	PE3516	162	71	PE3501	127	67	PE3461	128	93	PE34303	161	7	PE34520	Web	
PE3504	117	42	PE3523	152	69	PE3517	162	71	PE3502	127	67	PE3462	109	55	PE34304	161	7	PE34521	Web	
PE3505	110	78	PE3524	152	69	PE3518	161	81	PE3503	128	85	PE3463	108	54	PE34305	162	20	PE34522	Web	
PE3506	148	38	PE3525	152	69	PE3519	161	81	PE3504	133	28	PE3464	108	55	PE34306	157	82	PE34523	Web	
PE3507	148	38	PE3526	152	69	PE3520	139	53	PE3505	133	28	PE3465	108	55	PE34307	157	82	PE34524	Web	
PE3508	160	78	PE3527	148	77	PE3521	128	98	PE3506	165	11	PE3466	145	28	PE34308	151	37	PE34525	Web	
PE3509	148	34	PE3528	179	62	PE3522	125	99	PE3507	125	99	PE3467	109	56	PE34309	159	50	PE34526	Web	
PE3510	148	34	PE3529	109	47	PE3523	125	99	PE3508	125	99	PE3468	144	14	PE34310	159	50	PE34527	Web	
PE3511	148	34	PE3530	109	47	PE3524	125	99	PE3509	125	99	PE3469	144	14	PE34311	159	50	PE34528	Web	
PE3512	148	34	PE3531	109	47	PE3525	125	99	PE3510	125	99	PE3470	144	14	PE34312	159	50	PE34529	Web	
PE3513	148	34	PE3532	109	47	PE3526	125	99	PE3511	125	99	PE3471	144	14	PE34313	159	50	PE34530	Web	
PE3514	160	75	PE3533	109	47	PE3527	125	99	PE3512	125	99	PE3472	144	14	PE34314	159	50	PE34531	Web	
PE3515	160	75	PE3534	109	47	PE3528	125	99	PE3513	125	99	PE3473	144	14	PE34315	159	50	PE34532	Web	
PE3516	117	65	PE3535	109	47	PE3529	125	99	PE3514	125	99	PE3474	144	14	PE34316	159	50	PE34533	Web	
PE3517	117	65	PE3536	109	47	PE3530	125	99	PE3515	125	99	PE3475	144	14	PE34317	159	50	PE34534	Web	
PE3518	117	65	PE3537	109	47	PE3531	125	99	PE3516	125	99	PE3476	144	14	PE34318	159	50	PE34535	Web	
PE3519	143	76	PE3538	109	47	PE3532	125	99	PE3517	125	99	PE3477	144	14	PE34319	159	50	PE34536	Web	
PE3520	Web		PE3539	109	47	PE3533	125	99	PE3518	125	99	PE3478	144	14	PE34320	159	50	PE34537	Web	
PE3521	165	22	PE3540	109	47	PE3534	125	99	PE3519	125	99	PE3479	144	14	PE34321	159	50	PE34538	Web	
PE3522	117	50	PE3541	109	47	PE3535	125	99	PE3520	125	99	PE3480	144	14	PE34322	159	50	PE34539	Web	
PE3523	170	32	PE3542	109	47	PE3536	125	99	PE3521	125	99	PE3481	144	14	PE34323	159	50	PE34540	Web	
PE3524	170	32	PE3543	109	47	PE3537	125	99	PE3522	125	99	PE3482	144	14	PE34324	159	50	PE34541	Web	
PE3525	188	77	PE3544	109	47	PE3538	125	99	PE3523	125	99	PE3483	144	14	PE34325	159	50	PE34542	Web	
PE3526	188	77	PE3545	109	47	PE3539	125	99	PE3524	125	99	PE3484	144	14	PE34326	159	50	PE34543	Web	
PE3527	188	77	PE3546	109	47	PE3540	125	99	PE3525	125	99	PE3485	144	14	PE34327	159	50	PE34544	Web	
PE3528	188	77	PE3547	109	47	PE3541	125	99	PE3526	125	99	PE3486	144	14	PE34328	159	50	PE34545	Web	
PE3529	188	77	PE3548	109	47	PE3542	125	99	PE3527	125	99	PE3487	144	14	PE34329	159	50	PE34546	Web	
PE3530	188	77	PE3549	109	47	PE3543	125	99	PE3528	125	99	PE3488	144	14	PE34330	159	50	PE34547	Web	
PE3531	Web		PE3550	109	47	PE3544	125	99	PE3529	125	99	PE3489	144	14	PE34331	159	50	PE34548	Web	
PE3532	Web		PE3551	109	47	PE3545	125	99	PE3530	125	99	PE3490	144	14	PE34332	159	50	PE34549	Web	
PE3533	154	22	PE3552	109	47	PE3546	125	99	PE3531	125	99	PE3491	144	14	PE34333	159	50	PE34550	Web	
PE3534	141	7	PE3553	109	47	PE3547	125	99	PE3532	125	99	PE3492	144	14	PE34334	159	50	PE34551	Web	
PE3535	141	7	PE3554	109	47	PE3548	125	99	PE3533	125	99	PE3493	144	14	PE34335	159	50	PE34552	Web	
PE3536	141	7	PE3555	109	47	PE3549	125	99	PE3534	125	99	PE3494	144	14	PE34336	159	50	PE34553	Web	
PE3537	141	7	PE3556	109	47	PE3550	125	99	PE3535	125	99	PE3495	144	14	PE34337	159	50	PE34554	Web	
PE3538	183	67	PE3557	109	47	PE3551	125	99	PE3536	125	99	PE3496	144	14	PE34338	159	50	PE34555	Web	
PE3539	179	55	PE3558	109	47	PE3552	125	99	PE3537	125	99	PE3497	144	14	PE34339	159	50	PE34556	Web	
PE3540	179	55	PE3559	109	47	PE3553	125	99	PE3538	125	99	PE3498	144	14	PE34340	159	50	PE34557	Web	
PE3541	179	55	PE3560	109	47	PE3554	125	99	PE3539	125	99	PE3499	144	14	PE34341	159	50	PE34558	Web	
PE3542	179	55	PE3561	109	47	PE3555	125	99	PE3540	125	99	PE3500	144	14	PE34342	159	50	PE34559	Web	
PE3543	179	55	PE3562	109	47	PE3556	125	99	PE3541	125	99	PE3501	144	14	PE34343	159	50	PE34560	Web	
PE3544	179	55	PE3563	109	47	PE3557	125	99	PE3542	125	99	PE3502	144	14	PE34344	159	50	PE34561	Web	
PE3545	179	55	PE3564	109	47	PE3558	125	99	PE3543	125	99	PE3503	144	14	PE34345	159	50	PE34562	Web	
PE3546	179	55	PE3565	109	47	PE3559	125	99	PE3544	125	99	PE3504	144	14	PE34346	159	50	PE34563	Web	
PE3547	179	55	PE3566	109	47	PE3560	125	99	PE3545	125	99	PE3505	144	14	PE34347	159	50	PE34564	Web	
PE3548	179	55	PE3567	109	47	PE3561	125	99	PE3546	125	99	PE3506	144	14	PE34348	159	50	PE34565	Web	
PE3549	179	55	PE3568	109	47	PE3562	125	99	PE3547	125	99	PE3507	144	14	PE34349	159	50	PE34566	Web	
PE3550	179	55	PE3																	

PART NUMBER INDEX

Note: C/R stands for the Column and/or Row location of the specific product on a given page.

Model No.	Page	C/R	Model No.	Page	C/R	Model No.	Page	C/R	Model No.	Page	C/R	Model No.	Page	C/R	Model No.	Page	C/R			
PE35154	170	28	PE36123	Web		PE37828	Web		PE38140BL	Web		PE38750D	114	98	PE39344B	Web		PE39473	Web	
PE35207	156	66	PE36124	Web		PE37840	185	1	PE38140GR	Web		PE38750H	114	99	PE39344C	Web	66	PE39474	Web	43
PE35208	156	67	PE36125	Web		PE37841	Web	2	PE38141BK	Web		PE38750I	114	1	PE39344D	164	68	PE39475	155	50
PE35209	156	67	PE36126	Web		PE37842	Web		PE38140WH	Web		PE38750K	114	2	PE39344H	164	68	PE39476	163	52
PE35210	151	39	PE36127	186	12	PE37843	Web		PE38140YV	Web		PE38750L	114	3	PE39344I	164	69	PE39477	182	26
PE35212	151	41	PE36128	Web		PE37844	185	94	PE38141BK	Web		PE38751A	Web		PE39344K	164	70	PE39478	182	29
PE35213	156	69	PE36129	Web		PE37845	185	96	PE38141BL	Web		PE38751B	Web		PE39344L	164	71	PE39479	178	35
PE35214	157	67	PE36130	Web		PE37846	185	97	PE38141GR	Web		PE38751C	113	59	PE39345A	Web		PE39480	Web	
PE35216	157	88	PE36131	Web		PE37847	Web		PE38141RD	Web		PE38751D	Web		PE39345B	Web		PE39481	180	27
PE35217	156	71	PE36132	187	47	PE37848	137	19	PE38141WH	Web		PE38751H	Web		PE39345C	Web	72	PE39482	182	74
PE35218	Web		PE36133	187	46	PE37849	185	98	PE38141YV	Web		PE38751I	Web		PE39345D	Web		PE39483	163	50
PE35220	157	89	PE36135	187	48	PE37850	185	98	PE38161	138	24	PE38751K	Web		PE39345H	Web		PE39484	163	50
PE35221	156	77	PE36136	Web		PE37851	185	99	PE38184	168	80	PE38751Z	113	60	PE39345I	Web		PE39485	Web	
PE35222	Web		PE36137	187	51	PE37859	177	14	PE38194	132	91	PE38752A	113	68	PE39345J	Web		PE39486	181	13
PE35223	157	78	PE36138	Web		PE37885	177	3	PE38204	134	44	PE38752B	Web		PE39345Z	164	73	PE39487	Web	
PE35224	Web		PE36139	187	52	PE37900	151	33	PE38231	118	2	PE38752C	113	69	PE39346A	164	74	PE39488	180	86
PE35225	157	79	PE36140	100	22	PE37923	145	43	PE38240	150	2	PE38752D	113	70	PE39346B	Web		PE39489	155	59
PE35226	157	80	PE36141	187	49	PE37949	149	9	PE38249	153	71	PE38752E	113	71	PE39346C	164	75	PE39490	163	59
PE35227	157	80	PE36142	Web		PE37941	123	32	PE38270	138	23	PE38752F	113	72	PE39346D	Web		PE39491	182	27
PE35228	180	94	PE36143	187	50	PE37942	123	35	PE38271	138	22	PE38752G	113	73	PE39346H	Web		PE39492	182	30
PE35229	180	95	PE36144	Web		PE37943	123	36	PE38272	137	20	PE38752Z	113	74	PE39346I	164	75	PE39493	Web	
PE35230	180	95	PE36145	187	40	PE37944	125	7	PE38273	145	31	PE38753A	Web		PE39346K	164	76	PE39494	181	12
PE35231	180	99	PE36146	Web		PE37945	125	8	PE38274	145	32	PE38753B	Web		PE39346L	164	77	PE39495	Web	
PE35232	Web		PE36147	187	41	PE37946	125	9	PE38275	145	30	PE38753C	114	84	PE39346M	164	78	PE39496	180	87
PE35233	Web		PE36148	124	47	PE37947	124	47	PE38276	145	31	PE38753D	Web		PE39346N	164	79	PE39497	155	60
PE35234	180	96	PE36149	187	42	PE37948	124	41	PE38277	145	1	PE38753E	114	85	PE39346O	Web		PE39498	163	51
PE35235	Web		PE36150	175	51	PE37949	127	42	PE38278	Web		PE38753H	Web		PE39346P	164	75	PE39499	163	51
PE35236	180	97	PE36151	Web		PE37950	127	44	PE38296	Web		PE38753K	Web		PE39346Q	164	76	PE39500	163	51
PE35238	Web		PE36152	174	48	PE37951	127	45	PE38298	184	83	PE38753Z	114	86	PE39346R	Web		PE39501	Web	
PE35241	Web		PE36153	187	43	PE37952	99	16	PE38299	169	9	PE38754A	Web		PE39346T	164	77	PE39502	Web	
PE35242	Web		PE36154	Web		PE37953	Web		PE38300	170	20	PE38754B	Web		PE39346V	164	78	PE39503	Web	
PE35243	Web		PE36155	Web	44	PE37954	Web		PE38301	Web		PE38754C	114	5	PE39346W	164	79	PE39504	Web	
PE35244	Web		PE36156	Web		PE37955	Web	17	PE38302	183	56	PE38754D	114	6	PE39346X	164	80	PE39505	163	54
PE35245	131	80	PE36157	140	87	PE37956	Web		PE38303	183	56	PE38754E	114	7	PE39346Y	164	81	PE39506	163	54
PE35246	Web		PE36158	175	54	PE37957	Web		PE38304	183	52	PE38754F	Web		PE39346Z	164	82	PE39507	163	54
PE35247	132	81	PE36159	Web		PE37958	Web		PE38318	Web		PE38754G	Web		PE39347A	164	83	PE39508	163	54
PE35256	180	27	PE36160	175	52	PE37959	100	30	PE38322	118	3	PE38754H	114	8	PE39347B	164	84	PE39509	163	54
PE35269	122	1	PE36161	140	89	PE37960	Web		PE38343	187	53	PE38754I	Web		PE39347C	164	85	PE39510	163	54
PE35283	Web		PE36162	Web		PE37961	Web	80	PE38344	Web	80	PE38754J	Web		PE39347D	164	86	PE39511	163	54
PE35284	151	83	PE36163	Web		PE37962	Web		PE38345	Web		PE38754K	113	61	PE39347E	164	87	PE39512	163	54
PE35247	160	58	PE36164	153	74	PE37963	Web		PE38346	Web		PE38754L	Web		PE39347F	164	88	PE39513	163	54
PE35348	189	98	PE36165	Web		PE37969	Web		PE38407	175	70	PE38754M	Web		PE39347G	164	89	PE39514	163	54
PE35349	157	91	PE36166	153	76	PE37970	Web		PE38433	143	55	PE38754N	Web		PE39347H	164	90	PE39515	163	54
PE35350	189	94	PE36167	Web		PE37972	Web		PE38436	121	77	PE38754O	Web		PE39347I	164	91	PE39516	163	54
PE35351	152	43	PE36168	153	75	PE37973	Web		PE38438	Web		PE38754Z	113	62	PE39347J	164	92	PE39517	163	54
PE35352	189	99	PE36169	140	86	PE37978	130	44	PE38446	Web		PE38755A	Web		PE39347K	164	93	PE39518	163	54
PE35353	189	92	PE36170	Web	63	PE37979	149	63	PE38447	Web		PE38755B	Web		PE39347L	164	94	PE39519	163	54
PE35354	189	95	PE36171	Web		PE38040BK	Web		PE38448	Web		PE38755C	113	75	PE39347M	164	95	PE39520	163	54
PE35355	152	44	PE36172	122	89	PE38040BL	Web		PE38449	138	34	PE38755D	Web		PE39347N	164	96	PE39521	163	54
PE35356	189	1	PE36173	Web		PE38040GR	Web		PE38450	129	8	PE38755E	Web		PE39347O	164	97	PE39522	163	54
PE35357	157	93	PE36174	100	39	PE38040RD	Web		PE38451	129	9	PE38755F	113	76	PE39347P	164	98	PE39523	163	54
PE35358	189	96	PE36178	121	82	PE38040WH	Web		PE38452	129	7	PE38755G	113	77	PE39347Q	164	99	PE39524	163	54
PE35359	Web		PE38181	Web		PE38040YV	Web		PE38453	129	6	PE38755H	113	78	PE39347R	164	100	PE39525	163	54
PE35360	189	2	PE38200	143	57	PE38052	Web		PE38454	Web		PE38755I	113	79	PE39347S	164	101	PE39526	163	54
PE35361	189	94	PE38201	149	64	PE38055	Web	9	PE38455	Web		PE38755J	113	80	PE39347T	164	102	PE39527	163	54
PE35362	189	97	PE38219	108	28	PE38093	158	12	PE38456	Web		PE38755K	Web		PE39347U	164	103	PE39528	163	54
PE35363	Web		PE38228	Web		PE38116	145	29	PE38457	Web		PE38755L	Web		PE39347V	164	104	PE39529	163	54
PE35364	Web		PE38273	124	70	PE38130-12	Web		PE38485	138	36	PE38755M	Web		PE39347W	164	105	PE39530	163	54
PE35365	Web		PE38283	132	83	PE38130BK	Web		PE38486	138	35	PE38755N	Web		PE39347X	164	106	PE39531	163	54
PE35366	Web		PE38345	Web		PE38130BL	Web		PE38487	Web		PE38755O	Web		PE39347Y	164	107	PE39532	163	54
PE35367	Web		PE38346	131	77	PE38130GR	Web		PE38488	Web		PE38755P	114	12	PE39347Z	164	108	PE39533	163	54
PE35369	151	95	PE38347	150	3	PE38131BK	Web	12	PE38489	129	12	PE38755Q	Web		PE39348A	164	109	PE39534	163	54
PE35371	152	45	PE38455	112	39	PE38130WH	Web		PE38490	129	10	PE38755R	110	94	PE39348B	164	110	PE39535	163	54
PE35373	157	96	PE38475	148	14	PE38130YV	Web		PE38491	129	10	PE38755S	132	84	PE39348C	164	111	PE39536	163	54
PE35375	152	46	PE38507	158	28	PE38132-12	Web		PE38492	129	13	PE38755T	Web		PE39348D	164	112	PE39537	163	54
PE35384	139	51	PE38519	94	10	PE38132BK	Web		PE38493	135	66	PE38755U	115	14	PE39348E	164	113	PE39538	163	54
PE35404	168	76	PE38520	101	52	PE38132BL	Web		PE38494	135	65	PE38755V	156	58	PE39348F	164	114	PE39539	163	54
PE35430	153	81	PE38521	94	7	PE38132GR	Web		PE38495	135	67	PE38755W	184	82	PE39348G	164	115	PE39540	163	54
PE35463	157	82	PE38522	101	53															

PART NUMBER INDEX

Note: C/R stands for the Column and/or Row location of the specific product on a given page.

Model No.	Page	C/R	Model No.	Page	C/R	Model No.	Page	C/R	Model No.	Page	C/R	Model No.	Page	C/R	Model No.	Page	C/R	Model No.	Page	C/R
PE3C1830	140	90	PE3C4012	96	60	PE3C4844	102	66	PE3C5030	137	3	PE3CA1004	169	12	PE3M0064	90	66	PE3M0185	92	85
PE3C1831	150	85	PE3C4013	96	67	PE3C4845	106	62	PE3C5233	168	87	PE3CA1005	169	10	PE3M0065	90	67	PE3M0186	91	78
PE3C1832	174	34	PE3C4014	119	27	PE3C4846	109	69	PE3C5234	169	35	PE3CA1006	169	16	PE3M0066	90	68	PE3M0187	92	80
PE3C1888	174	34	PE3C4018	120	49	PE3C4848	104	22	PE3C5242	168	7	PE3CA1007	169	8	PE3M0067	90	72	PE3M0188	91	79
PE3C2000	93	94	PE3C4019	119	22	PE3C4849	107	85	PE3C5244	161	4	PE3CA1008	137	15	PE3M0068	90	73	PE3M0189	92	98
PE3C2001	93	95	PE3C4020	120	39	PE3C4850	102	80	PE3C5246	148	20	PE3CA1009	137	16	PE3M0069	91	74	PE3M0190	92	97
PE3C2002	93	92	PE3C4025	119	33	PE3C4851	102	77	PE3C5247	168	72	PE3CA1010	137	17	PE3M0070	90	69	PE3M0191	92	99
PE3C2003	93	57	PE3C4026	120	55	PE3C4852	102	72	PE3C5248	160	64	PE3CA1011	137	13	PE3M0071	90	70	PE3M0192	92	2
PE3C2004	93	58	PE3C4027	119	24	PE3C4853	102	85	PE3C5249	179	47	PE3CA1012	137	14	PE3M0072	91	71	PE3M0193	92	1
PE3C2005	93	98	PE3C4028	119	25	PE3C4854	103	99	PE3C5250	149	11	PE3CA1013	137	11	PE3M0073	91	75	PE3M0194	92	93
PE3C2006	93	96	PE3C4029	119	26	PE3C4855	103	99	PE3C5251	183	51	PE3CA1014	137	11	PE3M0074	91	75	PE3M0195	92	96
PE3C2007	93	74	PE3C4030	120	44	PE3C4856	105	38	PE3C5252	180	82	PE3CA1016	170	24	PE3M0075	91	79	PE3M0196	92	95
PE3C2008	93	75	PE3C4034	119	29	PE3C4857	103	6	PE3C5253	180	91	PE3CA1017	170	25	PE3M0076	91	76	PE3M0197	92	90
PE3C2009	93	26	PE3C4035	120	47	PE3C4858	106	75	PE3C5254	181	22	PE3CA1018	170	26	PE3M0077	91	78	PE3M0198	92	91
PE3C2010	93	27	PE3C4036	119	20	PE3C4859	105	44	PE3C5255	124	57	PE3CA1019	170	22	PE3M0078	91	80	PE3M0199	92	93
PE3C2011	93	99	PE3C4037	120	37	PE3C4860	103	93	PE3C5256	136	95	PE3CA1020	170	23	PE3M0079	91	15	PE3M0200	92	92
PE3C2012	93	97	PE3C4043	120	53	PE3C4861	106	68	PE3C5257	169	78	PE3CA1021	170	27	PE3M0080	91	16	PE3M0201	92	87
PE3C2013	93	59	PE3C4045	120	41	PE3C4862	104	32	PE3C5258	152	92	PE3CA1022	170	19	PE3M0081	91	18	PE3M0202	92	89
PE3C2014	93	98	PE3C4048	119	17	PE3C4863	104	16	PE3C5259	155	40	PE3CA1023	156	62	PE3M0082	91	17	PE3M0203	92	88
PE3C2015	93	60	PE3C4052	120	50	PE3C4864	106	82	PE3C5260	155	48	PE3CA1024	156	63	PE3M0083	91	19	PE3M0204	92	34
PE3C2034	109	46	PE3C4053	120	40	PE3C4865	105	54	PE3C5261	163	43	PE3CA1025	156	64	PE3M0084	91	25	PE3M0205	92	36
PE3C2035	141	98	PE3C4055	120	52	PE3C4866	103	11	PE3C5262	163	49	PE3CA1026	156	60	PE3M0085	90	19	PE3M0206	92	35
PE3C2162	144	5	PE3C4059	120	56	PE3C4867	106	77	PE3C5263	163	57	PE3CA1027	156	61	PE3M0086	90	20	PE3M0207	92	31
PE3C2180	183	48	PE3C4060	119	25	PE3C4868	105	49	PE3C5264	169	1	PE3CA1028	156	59	PE3M0087	90	21	PE3M0208	92	33
PE3C2220	131	75	PE3C4062	119	27	PE3C4869	106	71	PE3C5265	169	8	PE3CA1029	156	16	PE3M0088	90	22	PE3M0209	92	32
PE3C2276	131	75	PE3C4063	120	45	PE3C4870	104	79	PE3C5266	169	7	PE3CA1030	156	57	PE3M0089	90	23	PE3M0210	92	45
PE3C2295	109	44	PE3C4064	119	15	PE3C4871	105	51	PE3C5267	130	50	PE3CA1031	188	72	PE3M0090	91	96	PE3M0211	92	44
PE3C2305	161	98	PE3C4066	119	28	PE3C4872	102	70	PE3C5268	131	73	PE3CA1032	188	80	PE3M0091	91	97	PE3M0212	92	41
PE3C2360	141	3	PE3C4067	120	46	PE3C4873	106	65	PE3C5269	131	76	PE3CA1033	170	21	PE3M0092	91	98	PE3M0213	92	43
PE3C2404	122	2	PE3C4068	119	19	PE3C4874	105	60	PE3C5270	137	6	PE3CA1035	147	92	PE3M0093	91	1	PE3M0214	92	42
PE3C2416	109	51	PE3C4069	120	36	PE3C4875	104	26	PE3C5271	137	9	PE3CA1036	148	45	PE3M0094	91	2	PE3M0215	92	40
PE3C2495	175	12	PE3C4130	93	44	PE3C4876	107	84	PE3C5272	149	35	PE3CA1037	149	35	PE3M0095	91	3	PE3M0216	92	39
PE3C2528	175	10	PE3C4132	93	52	PE3C4877	102	83	PE3C5274	129	15	PE3CA1038	149	36	PE3M0096	91	99	PE3M0217	92	39
PE3C2599	175	12	PE3C4133	93	78	PE3C4878	102	83	PE3C5275	136	97	PE3CA1039	147	88	PE3M0097	91	3	PE3M0218	92	38
PE3C2884	160	66	PE3C4133	93	89	PE3C4879	102	76	PE3C5276	129	27	PE3CA1040	148	44	PE3M0098	91	5	PE3M0219	91	32
PE3C2892	151	27	PE3C4134	93	5	PE3C4880	102	87	PE3C5276	136	99	PE3CA1041	160	84	PE3M0099	91	23	PE3M0220	91	34
PE3C2953	133	24	PE3C4135	93	30	PE3C4881	103	4	PE3C5277	130	34	PE3CA1042	151	21	PE3M0100	90	24	PE3M0221	91	33
PE3C2985	159	43	PE3C4136	93	79	PE3C4882	106	73	PE3C5278	137	2	PE3CA1043	151	22	PE3M0101	90	25	PE3M0222	91	37
PE3C3028	159	43	PE3C4137	93	87	PE3C4883	105	42	PE3C5279	137	34	PE3CA1044	151	23	PE3M0102	90	26	PE3M0223	91	36
PE3C3115	153	18	PE3C4138	93	90	PE3C4884	103	90	PE3C5280	133	36	PE3CA1045	180	92	PE3M0103	90	27	PE3M0224	91	35
PE3C3159	165	98	PE3C4139	93	87	PE3C4885	106	76	PE3C5281	133	35	PE3CA1047	125	87	PE3M0104	90	28	PE3M0225	92	6
PE3C3205	166	36	PE3C4140	93	76	PE3C4886	105	48	PE3C5282	134	38	PE3CA1048	126	34	PE3M0105	91	6	PE3M0226	92	7
PE3C3221	175	55	PE3C4141	93	1	PE3C4887	103	97	PE3C5283	134	43	PE3CA1049	133	17	PE3M0106	91	7	PE3M0227	92	8
PE3C3233	132	1	PE3C4142	93	28	PE3C4888	106	69	PE3C5284	134	42	PE3CA1050	136	87	PE3M0107	91	8	PE3M0228	92	9
PE3C3234	135	62	PE3C4143	93	1	PE3C4889	104	36	PE3C5285	126	20	PE3CA1052	184	88	PE3M0108	91	10	PE3M0229	92	3
PE3C3235	146	61	PE3C4144	93	53	PE3C4890	104	20	PE3C5286	133	22	PE3CA1053	184	89	PE3M0109	91	11	PE3M0230	92	5
PE3C3236	144	94	PE3C4145	93	88	PE3C4891	105	88	PE3C5287	133	21	PE3CA1054	184	86	PE3M0110	91	8	PE3M0231	92	6
PE3C3237	144	98	PE3C4146	93	39	PE3C4892	105	58	PE3C5288	135	42	PE3CA1055	184	87	PE3M0111	91	9	PE3M0232	92	13
PE3C3238	159	32	PE3C4147	93	38	PE3C4893	103	12	PE3C5289	185	93	PE3CA1056	184	85	PE3M0112	91	12	PE3M0233	92	14
PE3C3240	126	21	PE3C4164	154	2	PE3C4894	106	78	PE3C5290	187	55	PE3CA1057	184	90	PE3M0113	91	14	PE3M0234	92	15
PE3C3241	127	49	PE3C4238	136	96	PE3C4895	105	50	PE3C5291	150	4	PE3CA1058	184	79	PE3M0114	91	24	PE3M0235	92	10
PE3C3242	154	8	PE3C4270	159	29	PE3C4896	104	14	PE3C5333	93	29	PE3CA1102	185	7	PE3M0115	90	1	PE3M0236	92	12
PE3C3243	134	39	PE3C4341	174	49	PE3C4897	106	80	PE3C5334	93	4	PE3CA1103	185	8	PE3M0116	90	2	PE3M0237	92	11
PE3C3244	159	47	PE3C4374	176	90	PE3C4898	105	52	PE3C5335	93	12	PE3CA1104	185	4	PE3M0117	90	3	PE3M0238	92	11
PE3C3246	144	9	PE3C4388	176	82	PE3C4899	103	7	PE3C5336	93	40	PE3CA1105	185	3	PE3M0118	90	4	PE3M0239	92	50
PE3C3248	148	22	PE3C4389	176	88	PE3C4900	106	61	PE3C5337	93	41	PE3CA1106	185	5	PE3M0119	91	81	PE3M0240	92	46
PE3C3249	159	40	PE3C4391	153	87	PE3C4901	104	21	PE3C5338	93	42	PE3CA1120	185	6	PE3M0120	91	82	PE3M0241	92	48
PE3C3252	144	99	PE3C4392	153	87	PE3C4902	107	84	PE3C5339	93	43	PE3CA1130	145	41	PE3M0121	91	84	PE3M0242	92	47
PE3C3255	128	92	PE3C4393	166	29	PE3C4903	102	79	PE3C5340	93	21	PE3M0001	90	5	PE3M0122	91	83	PE3M0243	92	54
PE3C3275	101	58	PE3C4395	168	91	PE3C4904	102	71	PE3C5841	93	3	PE3M0002	90	6	PE3M0123	91	85	PE3M0244	92	51
PE3C3286	143	96	PE3C4397	168	91	PE3C4905	102	84	PE3C5842	93	22	PE3M0003	90	7	PE3M0124	91	20	PE3M0245	92	53
PE3C3314	112	32	PE3C4399	130	38	PE3C4906	111	12	PE3C5843	93	23	PE3M0004	90	8	PE3M0125	91	4	PE3M0246	92	52
PE3C3318	171	45	PE3C4400	130	40	PE3C4907	106	70	PE3C5844	93	24	PE3M0005	90	9	PE3M0126	91	49	PE3M0247	91	38
PE3C3321	141	8	PE3C4403	176	83	PE3C4908	103	5	PE3C5845	93										

PART NUMBER INDEX

Note: C/R stands for the Column and/or Row location of the specific product on a given page.

Model No.	Page	C/R	Model No.	Page	C/R	Model No.	Page	C/R	Model No.	Page	C/R	Model No.	Page	C/R	Model No.	Page	C/R	Model No.	Page	C/R
PE3W00135	168	86	PE3W05426	174	44	PE4053	214	98	PE4184	248	4	PE4315	234	61	PE4447	251	4	PE4573	211	80
PE3W00140	122	5	PE3W05450	135	61	PE4054	252	43	PE4186	239	97	PE4316	234	57	PE4448	252	18	PE4574	211	82
PE3W00148	111	8	PE3W05481	132	62	PE4055	254	61	PE4188	238	61	PE4317	235	92	PE4449	252	19	PE4575	211	83
PE3W00169	113	58	PE3W05483	118	12	PE4056	216	46	PE4189	238	61	PE4320	215	42	PE4450	252	37	PE4576	210	57
PE3W00288	186	21	PE3W05498	174	45	PE4057	215	11	PE4190	238	19	PE4319	215	31	PE4451	252	36	PE4577	210	58
PE3W00314	116	42	PE3W05518	177	93	PE4058	215	12	PE4191	229	88	PE4321	214	1	PE4452	252	45	PE4578	210	59
PE3W00322	178	32	PE3W05541	182	43	PE4059	229	14	PE4192	222	36	PE4322	215	16	PE4453	252	46	PE4579	210	60
PE3W00365	146	77	PE3W05557	170	35	PE4060	231	80	PE4193	222	16	PE4323	234	50	PE4454	252	46	PE4580	210	61
PE3W00393	109	50	PE3W05610	183	55	PE4061	229	99	PE4194	234	51	PE4324	222	29	PE4455	252	38	PE4581	210	62
PE3W00415	137	61	PE3W05645	136	55	PE4062	227	12	PE4195	233	57	PE4324	266	13	PE4456	252	38	PE4582	210	63
PE3W00417	152	61	PE3W05645	182	55	PE4063	227	12	PE4196	239	76	PE4325	237	83	PE4457	252	51	PE4583	210	64
PE3W00417	124	77	PE3W05651	131	70	PE4064	254	97	PE4197	239	77	PE4326	237	84	PE4458	252	52	PE4584	210	65
PE3W00430	126	13	PE3W05673	175	56	PE4064SP	264	98	PE4198	231	17	PE4327	236	53	PE4459	252	53	PE4585	210	66
PE3W00504	144	96	PE3W05738	178	33	PE4065	263	88	PE4199	248	5	PE4328	231	81	PE4460	253	61	PE4586	210	67
PE3W00507	144	96	PE3W05740	175	58	PE4067	252	11	PE4200	243	20	PE4329	227	92	PE4461	253	62	PE4587	210	68
PE3W00572	178	41	PE3W05752	182	44	PE4068	253	57	PE4201	244	68	PE4330	229	4	PE4462	252	54	PE4588	210	69
PE3W00597	173	7	PE3W05762	183	54	PE4069	256	63	PE4202	246	69	PE4331	227	18	PE4463	252	63	PE4589	210	70
PE3W00676	127	46	PE3W05881	111	5	PE4070	215	6	PE4203	263	11	PE4332	236	95	PE4464	252	51	PE4590	210	71
PE3W00780	180	88	PE3W05930	170	34	PE4071	251	98	PE4204	215	13	PE4333	234	58	PE4465	253	68	PE4591	210	72
PE3W00790	95	26	PE3W05962	167	65	PE4072	229	1	PE4205	215	14	PE4334	250	56	PE4466	253	69	PE4592	210	73
PE3W00808	179	68	PE3W06017	176	73	PE4073	256	64	PE4206	214	73	PE4335	250	60	PE4467	253	78	PE4593	210	74
PE3W00825	166	35	PE3W06018	176	71	PE4074	244	64	PE4207	214	74	PE4336	250	61	PE4468	253	91	PE4594	210	75
PE3W00832	143	61	PE3W06055	166	27	PE4075	224	88	PE4208	215	23	PE4338	250	63	PE4469	253	92	PE4595	210	76
PE3W00852	159	33	PE3W06085	163	64	PE4076	224	94	PE4209	215	24	PE4339	250	64	PE4470	253	95	PE4596	210	77
PE3W00948	152	34	PE3W06425	159	59	PE4077	215	64	PE4210	233	57	PE4340	227	18	PE4471	253	96	PE4597	210	78
PE3W00921	159	33	PE3W06094	133	19	PE4078	215	29	PE4211	214	89	PE4341	250	66	PE4472	253	97	PE4598	210	79
PE3W00934	167	51	PE3W06305	112	44	PE4079	215	7	PE4212	215	15	PE4342	225	39	PE4473	253	98	PE4599	210	80
PE3W01041	108	31	PE3W06365	123	16	PE4080	243	16	PE4213	235	10	PE4343	234	52	PE4474	253	99	PE4600	210	81
PE3W01114	158	27	PE3W06405	136	98	PE4081	227	13	PE4214	235	94	PE4344	227	93	PE4475	253	18	PE4601	210	82
PE3W01127	126	14	PE3W06410	153	88	PE4082	214	90	PE4215	235	70	PE4345	214	93	PE4476	253	19	PE4602	210	83
PE3W01141	95	33	PE3W06417	130	28	PE4083	237	70	PE4217	239	98	PE4346	266	16	PE4477	253	19	PE4603	210	84
PE3W01263	153	37	PE3W06425	159	59	PE4084	215	71	PE4218	238	62	PE4347	266	18	PE4478	253	20	PE4604	210	85
PE3W01380	108	32	PE3W06481	133	23	PE4088	254	12	PE4219	238	62	PE4348	221	11	PE4479	253	21	PE4605	210	86
PE3W01357	108	32	PE3W06444	187	39	PE4089	266	20	PE4221	227	16	PE4349	234	53	PE4480	253	22	PE4606	210	87
PE3W01379	183	53	PE3W06468	116	53	PE4091	215	41	PE4222	228	30	PE4350	224	90	PE4481	253	22	PE4607	210	88
PE3W01570	116	56	PE3W06649	112	35	PE4092	215	4	PE4223	230	44	PE4352	214	59	PE4482	228	62	PE4608	210	89
PE3W01582	146	49	PE3W06660	159	56	PE4093	224	89	PE4224	227	17	PE4352	221	10	PE4483	228	63	PE4609	210	90
PE3W01626	143	66	PE3W06662	138	31	PE4094	245	81	PE4225	224	7	PE4353	238	51	PE4484	228	64	PE4610	210	91
PE3W01634	112	49	PE3W06701	153	77	PE4095	246	81	PE4226	224	98	PE4354	236	32	PE4485	228	64	PE4611	210	92
PE3W01719	176	28	PE3W06709	181	21	PE4096	246	35	PE4227	224	99	PE4355	236	82	PE4486	228	65	PE4612	210	93
PE3W01959	163	68	PE3W06717	176	72	PE4097	244	47	PE4228	224	24	PE4356	243	22	PE4487	253	94	PE4613	210	94
PE3W01985	162	68	PE3W06829	163	44	PE4098	224	95	PE4229	221	24	PE4358	243	33	PE4488	253	65	PE4614	210	95
PE3W01992	109	37	PE3W06862	111	7	PE4099	239	96	PE4229.401	221	25	PE4359	245	79	PE4489	228	51	PE4615	210	96
PE3W02012	128	99	PE3W06863	126	25	PE4100	234	56	PE4230	221	21	PE4360	243	40	PE4490	228	52	PE4616	210	97
PE3W02209	114	4	PE3W06905	172	84	PE4101	238	60	PE4231	234	43	PE4362	244	53	PE4491	228	56	PE4617	210	98
PE3W02215	131	72	PE3W06981	106	72	PE4104	266	15	PE4232	234	44	PE4364	244	48	PE4492	253	85	PE4618	210	99
PE3W02234	114	9	PE3W07024	187	39	PE4105	266	17	PE4233	234	44	PE4364	244	48	PE4493	253	85	PE4619	210	100
PE3W02356	131	68	PE3W07044	174	46	PE4106	215	22	PE4234	265	6	PE4366	243	24	PE4494	224	97	PE4620	210	101
PE3W02390	163	63	PE3W07068	119	14	PE4107	245	99	PE4235	265	8	PE4367	244	71	PE4495	224	20	PE4621	210	102
PE3W02458	147	84	PE3W07094	136	82	PE4108	236	59	PE4236	265	7	PE4368	263	43	PE4496	234	54	PE4622	210	103
PE3W02466	149	66	PE3W07181	155	41	PE4109	214	72	PE4237	265	9	PE4370	239	82	PE4497	234	55	PE4623	210	104
PE3W02547	127	72	PE3W07265	178	31	PE4110	263	55	PE4238	266	12	PE4371	230	30	PE4498	234	59	PE4624	210	105
PE3W02744	158	26	PE3W07334	167	69	PE4112	235	9	PE4239	234	64	PE4372	229	5	PE4499	234	65	PE4625	210	106
PE3W02882	117	62	PE3W07386	117	62	PE4113	230	42	PE4240	218	40	PE4374	218	35	PE4500	234	66	PE4626	210	107
PE3W02943	114	9	PE3W07480	137	39	PE4114	234	43	PE4241	218	40	PE4374	217	5	PE4501	234	67	PE4627	210	108
PE3W02945	168	85	PE3W07481	93	7	PE4115	237	8	PE4242	218	9	PE4376	228	31	PE4502	262	23	PE4628	210	109
PE3W02976	135	64	PE3W07489	93	91	PE4116	237	9	PE4243	218	10	PE4377	214	75	PE4503	262	23	PE4629	210	110
PE3W02993	148	32	PE3W07491	95	40	PE4117	238	21	PE4244	218	21	PE4378	214	60	PE4504	262	22	PE4630	210	111
PE3W02994	161	99	PE3W07532	119	31	PE4118	240	17	PE4245	243	34	PE4379	214	76	PE4505	262	27	PE4631	210	112
PE3W03014	152	64	PE3W07591	118	9	PE4119	238	49	PE4246	245	80	PE4380	214	77	PE4506	262	28	PE4632	210	113
PE3W03030	152	62	PE3W07602	188	64	PE4120	238	49	PE4247	214	58	PE4381	214	61	PE4507	262	17	PE4633	210	114
PE3W03032	152	62	PE3W07646	188	64	PE4121	238	49	PE4248	214	58	PE4382	214	62	PE4508	262	18	PE4634	210	115
PE3W03078	139	61	PE3W07647	182	25	PE4123	240	25	PE4249	264	68	PE4383	214	78	PE4509	262	18	PE4635	210	116
PE3W03154	120	43	PE3W07649	181	11	PE4125	236	35	PE4250	243	21	PE4384	214	79	PE4510	262	14	PE4636	210	117
PE3W03175	182	39	PE3W07653	118	10	PE4126	236	39	PE4251	263	46	PE4386	214	80	PE4511	262	19	PE4637	210	118

PART NUMBER INDEX

Note: C/R stands for the Column and/or Row location of the specific product on a given page.

Model No.	Page	C/R	Model No.	Page	C/R	Model No.	Page	C/R	Model No.	Page	C/R	Model No.	Page	C/R	Model No.	Page	C/R	Model No.	Page	C/R
PE4708	255	24	PE4883	222	56	PE44042	214	82	PE44192	242	4	PE44356	211	90	PE44510	233	20	PE44649K	219	66
PE4709	224	1	PE4884	223	61	PE44045	227	19	PE44193	242	5	PE44357	212	3	PE44511	233	27	PE44649Z	219	67
PE4710	214	62	PE4885	223	70	PE44046	227	27	PE44194	242	6	PE44358	211	97	PE44512	233	21	PE44650A	220	93
PE4711	216	56	PE4886	223	70	PE44047	245	93	PE44195	242	10	PE44359	211	97	PE44513	233	28	PE44650B	220	94
PE4712	216	56	PE4887	223	71	PE44048	244	49	PE44196	242	11	PE44360	212	5	PE44514	232	6	PE44650C	220	95
PE4713	216	57	PE4888	223	72	PE44049	234	62	PE44197	242	12	PE44361	211	92	PE44515	232	13	PE44650D	220	96
PE4714	216	63	PE4889	223	67	PE44050	256	69	PE44198	242	13	PE44362	211	93	PE44520	227	90	PE44650H	220	97
PE4715	216	58	PE4890	223	78	PE44051	256	66	PE44199	242	14	PE44363	211	95	PE44521	227	98	PE44650I	220	98
PE4716	216	59	PE4891	223	74	PE44052	256	70	PE44200	242	13	PE44364	211	96	PE44522	227	99	PE44650J	220	99
PE4717	216	64	PE4892	223	69	PE44053	256	67	PE44201	242	14	PE44365	211	98	PE44523	227	1	PE44650K	220	101
PE4718	216	60	PE4893	223	69	PE44054	256	68	PE44202	242	8	PE44366	211	99	PE44524	228	58	PE44651A	220	69
PE4719	216	65	PE4894	223	75	PE44055	256	75	PE44203	235	74	PE44367	211	1	PE44525	228	58	PE44651B	220	70
PE4720	216	61	PE4896	226	54	PE44056	256	76	PE44204	238	22	PE44368	211	2	PE44526	228	59	PE44651C	220	70
PE4721	216	66	PE4897	226	55	PE44057	256	73	PE44205	238	23	PE44369	223	80	PE44527	228	60	PE44651D	220	71
PE4722	216	67	PE4898	226	61	PE44058	256	74	PE44206	238	24	PE44370	223	81	PE44528	228	33	PE44651H	220	72
PE4726	216	68	PE4899	226	62	PE44059	256	77	PE44207	238	25	PE44371	223	84	PE44529	230	34	PE44651I	220	73
PE4727	217	73	PE4900	226	66	PE44060	256	78	PE44208	238	26	PE44372	223	85	PE44530	230	35	PE44651L	220	74
PE4728	217	74	PE4902	226	67	PE44061	256	17	PE44209	238	17	PE44373	223	86	PE44531	230	36	PE44652A	220	75
PE4729	216	70	PE4903	226	72	PE44062	251	1	PE44211	238	63	PE44377	223	86	PE44532	229	92	PE44652	259	56
PE4730	216	71	PE4904	226	71	PE44065	231	70	PE44212	238	64	PE44378	248	13	PE44533	229	93	PE44653	228	55
PE4731	217	75	PE4905	226	59	PE44066	231	71	PE44213	238	65	PE44379	248	1	PE44534	229	94	PE44654	252	34
PE4732	217	76	PE4906	264	84	PE44068	231	72	PE44214	238	66	PE44380	248	14	PE44535	229	95	PE44655	247	81
PE4733	216	72	PE4907	235	17	PE44069	231	73	PE44215	206	38	PE44381	248	2	PE44536	209	17	PE44656	211	75
PE4735	217	82	PE4908	214	86	PE44070	231	76	PE44216	206	44	PE44382	248	9	PE44537	210	38	PE44658	215	27
PE4736	217	83	PE4909	232	28	PE44071	231	77	PE44217	207	57	PE44383	248	4	PE44538	210	39	PE44659	220	74
PE4737	217	78	PE4910	238	32	PE44072	231	78	PE44220	204	41	PE44384	248	16	PE44539	210	42	PE44660	223	64
PE4738	217	79	PE4911	240	18	PE44073	231	79	PE44227	207	72	PE44385	248	22	PE44540	210	43	PE44661	223	65
PE4739	217	80	PE4912	236	29	PE44074	231	89	PE44229	207	83	PE44386	248	23	PE44541	210	55	PE44662	226	70
PE4740	217	84	PE4913	236	30	PE44075	231	90	PE44232	207	69	PE44387	249	25	PE44545	210	70	PE44663	226	58
PE4741	217	85	PE4914	238	43	PE44076	231	91	PE44235	238	27	PE44388	249	31	PE44546	210	56	PE44664	240	28
PE4742	217	81	PE4915	215	35	PE44077	231	68	PE44236	240	26	PE44389	249	32	PE44548	210	71	PE44665	241	55
PE4743	217	82	PE4916	215	36	PE44078	231	69	PE44237	240	27	PE44390	249	34	PE44549	210	72	PE44666	241	56
PE4744	217	87	PE4917	235	18	PE44080	234	63	PE44238	240	22	PE44391	249	30	PE44550	210	73	PE44667	235	28
PE4745	217	88	PE4918	235	19	PE44083	225	43	PE44239	240	23	PE44392	249	40	PE44551	211	74	PE44669	237	90
PE4746	217	92	PE4919	237	77	PE44084	225	44	PE44240	240	15	PE44393	249	41	PE44554	229	84	PE44670	254	5
PE4747	217	89	PE4920	237	78	PE44085	225	45	PE44241	240	16	PE44394	249	50	PE44555	229	9	PE44671	255	32
PE4748	217	90	PE4921	238	16	PE44086	225	46	PE44242	205	1	PE44395	249	46	PE44558	209	25	PE44672	254	6
PE4749	217	93	PE4922	238	17	PE44087	225	47	PE44243	205	2	PE44396	230	23	PE44560	210	63	PE44673	255	33
PE4750	217	94	PE4923	238	18	PE44088	225	48	PE44244	205	3	PE44397	230	24	PE44561	210	64	PE44674	255	34
PE4752	217	91	PE4924	238	58	PE44089	225	48	PE44247	205	6	PE44398	231	92	PE44565	229	10	PE44675	255	35
PE4755	217	95	PE4926	243	37	PE44090	225	41	PE44248	205	6	PE44401	248	17	PE44568	209	26	PE44676	255	36
PE4756	217	1	PE4927	245	83	PE44091	225	51	PE44249	205	7	PE44402	248	18	PE44569	210	49	PE44687	259	42
PE4757	217	96	PE4928	263	54	PE44092	225	49	PE44254	205	10	PE44403	249	26	PE44572	259	72	PE44688	258	35
PE4758	217	97	PE4930	238	18	PE44093	Web		PE44255	205	11	PE44404	249	27	PE44573	259	73	PE44690	235	13
PE4759	217	3	PE4931	238	59	PE44094	244	50	PE44256	205	12	PE44405	249	35	PE44574	262	34	PE44691	236	25
PE4760	217	4	PE4932	237	79	PE44095	245	94	PE44257	205	9	PE44406	249	36	PE44576	262	35	PE44692	237	73
PE4761	217	69	PE4933	244	93	PE44096	245	95	PE44258	205	10	PE44407	249	37	PE44577	262	36	PE44693	237	74
PE4763	217	2	PE4934	228	36	PE44098	218	27	PE44259	205	13	PE44408	248	15	PE44578	258	27	PE44694	237	12
PE4764	217	98	PE4935	229	74	PE44099	218	28	PE44260	205	15	PE44419	248	19	PE44579	260	79	PE44695	238	13
PE4765	217	99	PE4936	229	79	PE44100	224	3	PE44261	205	16	PE44420	248	20	PE44580	262	36	PE44696	238	54
PE4766	240	35	PE4937	229	80	PE44102	224	4	PE44262	257	96	PE44421	248	21	PE44582	259	70	PE44697	238	55
PE4767	240	31	PE4938	229	75	PE44103	224	5	PE44263	257	97	PE44422	248	24	PE44583	262	30	PE44698	228	57
PE4768	240	39	PE4940	230	39	PE44104	224	8	PE44264	257	98	PE44423	249	28	PE44584	258	7	PE44699	226	63
PE4769	240	36	PE4941	230	40	PE44105	224	12	PE44265	257	99	PE44425	249	29	PE44585	260	83	PE44700	228	32
PE4770	240	36	PE4942	230	53	PE44106	224	13	PE44266	257	100	PE44426	249	33	PE44586	260	84	PE44701	228	33
PE4771	240	33	PE4943	230	54	PE44107	224	9	PE44267	257	2	PE44427	249	37	PE44587	259	41	PE44702	229	76
PE4772	240	40	PE4945	229	20	PE44108	224	10	PE44268	257	5	PE44428	249	38	PE44588	261	99	PE44703	229	77
PE4773	240	37	PE4946	230	59	PE44109	224	14	PE44270	257	3	PE44429	249	39	PE44590	261	5	PE44704	229	15
PE4774	Web		PE4949	218	17	PE44110	224	11	PE44271	257	4	PE44430	248	10	PE44591	239	67	PE44705	229	16
PE4775	240	41	PE4950	218	11	PE44111	224	15	PE44274	248	91	PE44431	248	11	PE44593	240	24	PE44706	230	55
PE4777	240	34	PE4951	218	12	PE44112	224	23	PE44275	248	92	PE44432	248	12	PE44594	256	83	PE44707	230	56
PE4778	241	48	PE4952	218	11	PE44113	224	18	PE44276	248	93	PE44433	249	17	PE44595	256	84	PE44708	230	57
PE4780	241	48	PE4953	218	14	PE44115	265	10	PE44277	209	23	PE44434	249	51	PE44599	233	33	PE44709	252	25
PE4782	241	51	PE4954	218	15	PE44116	266	14	PE44278	209	24	PE44435	249	52	PE44600	233	34	PE44710	252	49
PE4784	241	49	PE4955	218	18	PE44117	Web		PE44280	210	45	PE44436	249	44	PE44601	233	35	PE44711	252	50
PE4785	240	45	PE4957	218	22	PE44118	234	60	PE44282	21										

PART NUMBER INDEX

Note: C/R stands for the Column and/or Row location of the specific product on a given page.

Model No.	Page	C/R	Model No.	Page	C/R	Model No.	Page	C/R	Model No.	Page	C/R	Model No.	Page	C/R	Model No.	Page	C/R			
PE44825	228	25	PE45011	208	87	PE45287	247	86	PE45445	252	48	PE51049	57	12	PE51MP1011	62	83	PE55C3032	Web	
PE44826	235	1	PE45012	240	43	PE45289	247	89	PE45446	222	26	PE51050	58	19	PE51OM1001	62	4	PE55C3033	Web	
PE44827	238	29	PE45032	211	91	PE45292	238	42	PE45447	230	52	PE51052	58	20	PE51OM1002	63	8	PE55C3034	Web	
PE44828	256	72	PE45035	224	25	PE45295	208	97	PE45448	229	73	PE51054	57	2	PE51OM1003	63	9	PE55C3035	Web	
PE44830	223	58	PE45036	230	27	PE45296	208	98	PE45450	207	70	PE51055	61	32	PE51OM1004	62	5	PE55C3038	Web	
PE44840	246	27	PE45037	209	28	PE45297	209	99	PE4490BK	Web		PE51056	61	31	PE51OM1005	62	6	PE55C3039	Web	
PE44842	250	62	PE45039	239	84	PE45298	209	1	PE45404Z	Web		PE51057	59	61	PE51OM1006	63	10	PE55TL1000	313	
PE44843	214	97	PE45040	235	79	PE45299	209	2	PE45451	207	71	PE51058	59	63	PE51OM1007	62	99	PE55TR1000	Web	
PE44844	229	65	PE45041	236	63	PE45300	209	3	PE45452	207	55	PE51059	59	62	PE51OM1008	62	91	PE55TR1001	Web	
PE44845	Web		PE45042	235	2	PE45301	209	4	PE45453	207	56	PE51060	60	88	PE51OM1009	62	98	PE55TR1002	Web	
PE44846	252	40	PE45045	213	54	PE45302	209	9	PE45454	206	42	PE51061	59	69	PE51OM1010	62	2	PE55TR1003	Web	
PE44847	254	1	PE45046	210	44	PE45303	209	10	PE45455	206	43	PE51062	59	66	PE51OM1011	62	3	PE55TR1004	Web	
PE44848	245	4	PE45047	230	38	PE45304	209	15	PE45456	206	33	PE51063	59	67	PE51OM1012	62	7	PE55TR1005	Web	
PE44849	246	28	PE45048	237	64	PE45306	209	16	PE45457	206	34	PE51064	59	71	PE51OM1013	62	88	PE55TR1006	Web	
PE44852	226	65	PE45050	223	82	PE45307	221	23	PE45458	237	92	PE51065	59	74	PE51OM1014	62	89	PE55TR1007	Web	
PE44872	263	51	PE45051	223	83	PE45310	212	14	PE45459	237	90	PE51069	60	81	PE51OM1015	62	90	PE55TR1008	Web	
PE44874	224	62	PE45052	232	12	PE45311	212	14	PE45460	237	90	PE51067	61	78	PE51OM1016	62	91	PE55TR1009	Web	
PE44875	244	62	PE45054	Web		PE45313	212	15	PE45461	235	91	PE51068	60	80	PE51OM1017	62	93	PE55TR1010	Web	
PE44876	245	74	PE45055	239	88	PE45314	212	16	PE45462	237	1	PE51070	61	59	PE51OM1018	62	94	PE55TR1011	Web	
PE44877	230	37	PE45064	215	21	PE45315	212	9	PE45463	237	2	PE51072	61	54	PE51OM1019	62	92	PE55TR1012	Web	
PE44879	246	15	PE45065	251	6	PE45316	212	10	PE45464	237	3	PE51076	61	46	PE51OM1020	62	86	PE55TR1013	Web	
PE44880	246	16	PE45067	239	85	PE45317	212	11	PE45465	237	4	PE51077	61	45	PE51OM1021	62	87	PE55TR1014	Web	
PE44886	215	33	PE45071	243	91	PE45318	212	12	PE45466	237	5	PE51078	61	47	PE51OM1022	60	1	PE55TR1015	Web	
PE44887	216	41	PE45072	243	86	PE45319	212	13	PE45467	237	6	PE51080	61	50	PE51OM1023	62	97	PE55TR1016	Web	
PE44888	216	48	PE45086	267	31	PE45320	212	33	PE45468	207	76	PE51081	61	53	PE51OM1024	62	91	PE55TR1019	Web	
PE44890	216	44	PE45114	213	55	PE45321	213	41	PE45469	207	77	PE51082	61	51	PE51OM1025	62	95	PE55TR1020	Web	
PE44891	216	45	PE45116	258	15	PE45322	213	44	PE45470	207	78	PE51083	61	52	PE51OM1026	62	96	PE6002	307	10
PE44892	254	3	PE45117	258	16	PE45323	213	40	PE45471	207	79	PE51084	61	55	PE51PD1001	58	42	PE6006	267	49
PE44893	256	62	PE45119	243	23	PE45324	212	34	PE45472	206	46	PE51085	61	56	PE51PD1002	58	40	PE6007	267	52
PE44894	253	93	PE45126	246	46	PE45325	212	35	PE45473	206	47	PE51087	61	48	PE51PD1003	58	41	PE6009	308	73
PE44895	242	41	PE45127	246	54	PE45326	212	42	PE45474	206	48	PE51088	61	49	PE51PD1004	58	42	PE6012	267	44
PE44896	242	19	PE45128	248	90	PE45327	213	43	PE45475	206	49	PE51089	61	27	PE51PD1005	58	38	PE6013	267	3
PE44897	253	80	PE45130	253	94	PE45328	213	36	PE45476	206	50	PE51090	61	42	PE51PD1006	58	39	PE6014	267	4
PE44898	253	86	PE45131	215	28	PE45329	213	49	PE45477	206	29	PE51092	59	64	PE51RD1002	62	68	PE6015	267	5
PE44899	253	70	PE45132	253	95	PE45330	213	50	PE45478	256	79	PE51098	59	57	PE51RD1003	62	70	PE6016	267	16
PE44900	253	71	PE45133	231	74	PE45331	213	51	PE45479	234	46	PE51113	60	93	PE51RD1004	62	69	PE6017	267	17
PE44901	253	96	PE45134	239	68	PE45332	213	48	PE45480	236	27	PE51117A	61	36	PE51RD1005	62	72	PE6018	267	18
PE44902	253	46	PE45135	235	15	PE45333	212	30	PE45481	236	28	PE51119	61	34	PE51RD1006	61	34	PE6019	267	22
PE44903	247	47	PE45136	238	39	PE45334	212	46	PE45482	237	75	PE51120	61	35	PE51RD1007	62	67	PE6020	267	23
PE44906	247	57	PE45137	237	91	PE45335	212	7	PE45483	207	63	PE51121	61	38	PE51SE1001	59	51	PE6021	267	35
PE44907	246	48	PE45138	238	40	PE45336	212	8	PE45484	206	26	PE51122	61	39	PE51SE1002	59	52	PE6022	267	45
PE44908	248	93	PE45139	236	37	PE45337	213	37	PE45485	207	64	PE51123	61	40	PE51SE1003	59	48	PE6023	267	33
PE44909	247	59	PE45140	235	3	PE45338	213	38	PE45486	207	65	PE51124	61	41	PE51SE1004	59	46	PE6024	267	23
PE44910	246	29	PE45141	238	41	PE45339	212	25	PE45487	207	66	PE51125A	61	60	PE51SE1005	59	47	PE6026	310	2
PE44911	248	94	PE45142	235	4	PE45340	213	45	PE45490	250	68	PE51126	61	61	PE51SE1006	59	45	PE6028	267	43
PE44912	247	60	PE45143	235	56	PE45341	212	42	PE45491	250	69	PE51127	61	62	PE51SE1007	59	44	PE6029	267	47
PE44913	248	95	PE45145	235	80	PE45342	212	18	PE45492	250	70	PE51128	61	63	PE51SE1008	59	54	PE6032	308	76
PE44914	248	96	PE45147	245	3	PE45343	212	19	PE45493	250	80	PE51129	58	21	PE51SE1009	59	50	PE6033	310	1
PE44915	248	97	PE45150	215	19	PE45344	212	20	PE45494	250	81	PE51133	61	44	PE51TM1000	60	79	PE6034	308	11
PE44916	246	49	PE45153	249	55	PE45345	212	22	PE45496	250	73	PE51134	61	58	PE51TM1001	63	20	PE6035	308	14
PE44917	247	84	PE45155	244	65	PE45346	212	23	PE45497	250	74	PE51135A	61	57	PE51TM1002	60	5	PE6036	308	16
PE44918	247	67	PE45156	245	82	PE45347	212	21	PE45498	250	75	PE51136	60	4	PE51VA1001	58	32	PE6037	309	31
PE44919	247	66	PE45157	244	95	PE45348	212	24	PE45499	250	76	PE51137	61	65	PE51VA1002	58	33	PE6038	309	32
PE44920	247	68	PE45158	243	36	PE45349	213	39	PE45500	260	84	PE51143	61	65	PE51VA1003	58	34	PE6039	309	55
PE44921	247	69	PE45159	244	51	PE45350	212	26	PE45507	207	80	PE51144	61	66	PE51VA1004	58	31	PE6040	309	60
PE44922	247	70	PE45161	251	97	PE45351	212	27	PE45508	207	81	PE51145	60	6	PE51VA1005	58	36	PE6041	309	75
PE44923	247	71	PE45162	250	57	PE45352	212	28	PE45509	207	59	PE51146	60	7	PE51VA1006	58	35	PE6043	309	82
PE44924	247	72	PE45164	266	19	PE45353	212	29	PE45510	207	60	PE51147	61	14	PE51VA1007	58	22	PE6046	267	1
PE44925	247	73	PE45165	242	96	PE45354	213	47	PE45511	206	51	PE51148	60	10	PE51VA1008	58	23	PE6057	267	7
PE44926	247	74	PE45166	205	4	PE45355	212	31	PE45512	206	52	PE51149	61	11	PE51VA1009	58	24	PE6058	267	2
PE44927	247	75	PE45167	222	43	PE45356	212	72	PE45513	206	36	PE51150	61	18	PE51VA1010	58	25	PE6060	267	12
PE44928	247	76	PE45169	222	40	PE45358	250	71	PE45514	204	37	PE51151	61	20	PE51VA1011	58	26	PE6069	307	33
PE44930	247	77	PE45170	211	86	PE45366	250	72	PE45515	204	30	PE51152	61	17	PE51VA1012	58	28	PE6070	307	11
PE44931	247	61	PE45171	211	94	PE45370	251	82	PE45516	206	31	PE51153	61	15	PE51VA1013	58	29	PE6071	307	35
PE44932	247	65	PE45172	229	97	PE45371	251	83	PE45517	205	20	PE51154	61	19	PE51VA1014	58	30	PE6072	307	34
PE44933	247	66	PE45173	230	51	PE45375	251	84	PE45518	205	21	PE51155	61							

PART NUMBER INDEX

Note: C/R stands for the Column and/or Row location of the specific product on a given page.

Model No.	Page	C/R	Model No.	Page	C/R	Model No.	Page	C/R	Model No.	Page	C/R	Model No.	Page	C/R	Model No.	Page	C/R	Model No.	Page	C/R
PE6133	267	53	PE6826	347	83	PE7050-1	79	37	PE70A1001	80	44	PE71S3901	299	9	PE71S6166	289	43	PE71S6287	298	94
PE6134	Web		PE6828	346	49	PE7051-1	70	36	PE70A1008	80	45	PE71S3900	298	7	PE71S6167	289	45	PE71S6288	298	96
PE6135	267	55	PE6829	346	55	PE7052-1	71	44	PE70A1009	68	20	PE71S5001	299	1	PE71S6168	289	39	PE71S6289	298	97
PE6136	267	54	PE6830	347	60	PE7053-1	72	54	PE70A1010	68	21	PE71S5002	299	4	PE71S6169	289	41	PE71S6290	298	98
PE6137	309	71	PE6831	347	65	PE7054-1	73	74	PE70A1011	68	22	PE71S5003	299	6	PE71S6170	289	51	PE71S6291	298	99
PE6138	308	8	PE6832	347	70	PE7055-10	75	99	PE70A1012	68	23	PE71S5004	299	7	PE71S6171	289	53	PE71S6292	298	95
PE6139	308	99	PE6833	347	76	PE7056-30	78	24	PE70A1013	68	24	PE71S5005	299	2	PE71S6172	289	47	PE71S6293	289	62
PE6140	308	19	PE6834	347	79	PE7057-1	79	38	PE70A1014	68	25	PE71S5006	299	5	PE71S6173	289	49	PE71S6294	289	63
PE6141	308	10	PE6835	347	84	PE7061-6	81	53	PE70A1015	68	26	PE71S6052	294	51	PE71S6174	289	44	PE71S6295	289	64
PE6143	267	36	PE6836	347	64	PE7062-4	81	52	PE70A1016	68	27	PE71S6053	294	52	PE71S6175	289	46	PE71S6296	289	65
PE6144	267	34	PE68R000	310	99	PE7063-6	81	54	PE70A1017	68	28	PE71S6054	294	54	PE71S6176	289	40	PE71S6297	289	68
PE6146	307	7	PE68R001	310	3	PE7064-6	81	55	PE70A1021	79	42	PE71S6055	294	53	PE71S6177	289	42	PE71S6298	289	69
PE6150	307	29	PE68R002	307	42	PE7066	311	7	PE70A1022	80	48	PE71S6056	294	65	PE71S6178	289	52	PE71S6299	289	66
PE6151	307	32	PE68R003	310	98	PE7067	311	6	PE70A1023	80	50	PE71S6057	294	66	PE71S6179	289	54	PE71S6300	289	67
PE6154	308	66	PE68R004	310	97	PE7068	311	8	PE70A1024	80	47	PE71S6058	289	26	PE71S6180	289	48	PE71S6301	290	81
PE6156	308	65	PE68R005	307	44	PE7069	311	9	PE70A1025	81	57	PE71S6059	289	25	PE71S6181	289	50	PE71S6302	290	74
PE6160	307	48	PE68R006	308	43	PE7070	311	14	PE70A1031	82	84	PE71S6060	291	65	PE71S6182	289	55	PE71S6303	290	77
PE6161	307	46	PE68R007	308	63	PE7071	311	12	PE70A2000	82	87	PE71S6061	292	71	PE71S6183	288	12	PE71S6304	290	78
PE6162	307	9	PE68R008	308	64	PE7072	311	10	PE70A2001	82	88	PE71S6062	292	70	PE71S6184	288	7	PE71S6305	289	72
PE6163	307	8	PE68R009	308	70	PE7073	311	15	PE70A2002	82	89	PE71S6063	292	72	PE71S6185	288	9	PE71S6306	289	73
PE6165	310	96	PE68R010	308	67	PE7074	311	17	PE70A2003	82	90	PE71S6064	292	99	PE71S6186	288	18	PE71S6307	289	70
PE6168	309	77	PE68R011	308	74	PE7075	311	21	PE70A2900	82	86	PE71S6065	292	8	PE71S6187	288	20	PE71S6308	289	71
PE6169	309	71	PE68R012	308	71	PE7076	311	23	PE70A3900	82	80	PE71S6066	292	7	PE71S6188	288	14	PE71S6309	290	92
PE6171	309	88	PE68R013	308	89	PE7077	311	25	PE70A3901	82	81	PE71S6067	293	10	PE71S6189	288	15	PE71S6310	290	93
PE6173	307	19	PE68R014	308	87	PE7078	311	27	PE70A4000	82	82	PE71S6068	293	11	PE71S6190	288	11	PE71S6311	290	88
PE6174	307	18	PE68R015	308	94	PE7079	311	28	PE70A4000	82	64	PE71S6069	292	9	PE71S6191	288	13	PE71S6312	290	89
PE6176	307	20	PE68R016	308	90	PE7081	311	29	PE70A5000	82	70	PE71S6070	292	6	PE71S6192	288	8	PE71S6313	290	84
PE6176	307	54	PE68R028	308	97	PE7082	311	30	PE70A5001	82	71	PE71S6071	293	12	PE71S6193	288	10	PE71S6314	290	85
PE6177	307	53	PE68R029	309	49	PE7083	311	19	PE70A5002	82	72	PE71S6072	291	58	PE71S6194	288	19	PE71S6315	290	82
PE6178	307	17	PE68R030	309	37	PE7084-30	78	32	PE70A5003	81	57	PE71S6073	291	59	PE71S6195	288	21	PE71S6316	290	83
PE6178	307	44	PE68R031	309	58	PE7085	78	33	PE70A5004	82	66	PE71S6074	291	60	PE71S6196	288	17	PE71S6317	290	86
PE6180	307	52	PE68R032	309	83	PE7087-0	49	34	PE70A5005	81	68	PE71S6075	293	36	PE71S6197	288	17	PE71S6318	290	23
PE6181	307	13	PE68R033	310	87	PE7088-0	66	6	PE70A5006	82	67	PE71S6076	292	86	PE71S6198	288	5	PE71S6319	290	21
PE6182	307	2	PE68R034	310	90	PE7089-10	66	5	PE70A5007	82	69	PE71S6077	293	32	PE71S6199	288	6	PE71S6320	290	22
PE6183	307	12	PE68R035	310	91	PE7090-3	67	15	PE70A5008	82	78	PE71S6078	292	3	PE71S6200	288	3	PE71S6321	291	33
PE6184	307	1	PE68R036	310	92	PE7091-0	68	29	PE70A5009	82	73	PE71S6079	292	96	PE71S6201	288	4	PE71S6322	291	34
PE6185	308	13	PE68R037	307	61	PE7092-1	69	33	PE70A5010	82	75	PE71S6080	292	83	PE71S6202	289	57	PE71S6323	291	37
PE6186	308	2	PE68R038	307	31	PE7100	294	67	PE7100	294	67	PE71S6081	292	84	PE71S6203	289	58	PE71S6324	291	38
PE6187	308	1	PE68R039	308	23	PE7101	292	68	PE7101	292	68	PE71S6082	291	60	PE71S6204	289	55	PE71S6325	289	39
PE6188	309	48	PE68R040	308	22	PE7103	294	69	PE70A5013	82	74	PE71S6083	292	87	PE71S6205	289	56	PE71S6327	289	40
PE6189	309	47	PE68R041	308	20	PE7120D	297	54	PE70A6000	82	77	PE71S6084	292	2	PE71S6206	288	2	PE71S6328	290	95
PE6190	307	60	PE68R042	308	21	PE7139	295	74	PE70A6001	82	79	PE71S6085	294	50	PE71S6207	288	1	PE71S6329	292	4
PE6191	309	43	PE68R043	309	41	PE7139-CART	287	92	PE70A8000	81	59	PE71S6086	294	49	PE71S6208	296	17	PE71S6330	292	5
PE6193	267	39	PE68R045	309	40	PE7140	295	75	PE70A8001	81	58	PE71S6087	294	63	PE71S6209	295	81	PE71S6331	294	61
PE6194	267	37	PE68R046	309	38	PE7152	297	61	PE70A8002	81	63	PE71S6088	294	64	PE71S6210	296	13	PE71S6332	293	47
PE6195	267	38	PE68R047	309	39	Web	Web		PE70A8003	81	61	PE71S6089	293	91	PE71S6211	296	42	PE71S6333	293	48
PE6196	308	62	PE68R048	309	65	PE7160	Web		PE70A8004	81	61	PE71S6091	Web		PE71S6212	297	63	PE71S6334	293	45
PE6197	309	69	PE68R049	309	64	PE7161-1	67	11	PE7161-1	67	11	PE71S6092	294	72	PE71S6213	298	88	PE71S6335	294	55
PE6198	309	51	PE68R050	309	63	PE7162-1	69	30	PE70A9000	82	91	PE71S6093	294	73	PE71S6214	295	82	PE71S6336	294	56
PE6199	307	25	PE68R051	Web		PE7201-3	76	50	PE70A9001	82	92	PE71S6094	290	94	PE71S6215	296	14	PE71S6337	294	57
PE6200	346	44	PE68R052	309	76	PE7202-3	77	16	PE70A9002	82	93	PE71S6095	Web		PE71S6216	296	43	PE71S6338	294	58
PE6201	Web		PE68R053	309	79	PE7203-3	75	3	PE70A9003	82	94	PE71S6096	290	96	PE71S6217	297	64	PE71S6339	294	62
PE6201A	310	61	PE68R054	309	80	Web	Web		PE70A9004	82	95	PE71S6097	290	97	PE71S6218	297	65	PE71S6340	294	63
PE6202	310	95	PE68R055	309	72	PE7205-3	76	17	PE70A9005	82	96	PE71S6098	290	1	PE71S6219	296	35	PE71S6341	294	60
PE6202-100PK	310	93	PE68R056A	309	66	PE7206-3	77	10	PE70A9006	82	97	PE71S6099	290	2	PE71S6220	295	95	PE71S6342	293	46
PE6202-25PK	310	94	PE68R056B	309	67	PE7207-3	76	7	PE70A9007	82	98	PE71S6100	290	98	PE71S6221	296	32	PE71S6344	Web	
PE6203	309	32	PE68R057	308	78	PE7208-3	77	18	PE7208-3	77	18	PE71S6101	290	99	PE71S6222	290	51	PE71S6345	294	70
PE6204	309	33	PE68R057	307	41	PE7210-30	78	25	PE70A9009	83	1	PE71S6102	290	13	PE71S6223	297	74	PE71S6346	294	71
PE6205	309	28	PE68R058	307	28	PE7211-3	75	4	PE70A9010	83	2	PE71S6103	290	14	PE71S6224	298	90	PE71S6347	291	62
PE6206	309	30	PE68R059	307	41	PE7212-3	76	8	PE70A9011	83	3	PE71S6104	290	11	PE71S6225	295	99	PE71S6348	292	52
PE6207	309	35	PE68R060	307	47	PE7213-3	77	19	PE70A9012	83	4	PE71S6105	290	12	PE71S6226	296	33	PE71S6349	293	49
PE6208	309	36	PE68R061	307	21	PE7214-3	77	14	PE70A9013	83	5	PE71S6106	290	17	PE71S6227	297	53	PE71S6350	292	69
PE6209	308	25	PE68R062	307	22	PE7216-50	Web		PE70A9014	83	6	PE71S6107	290	18	PE71S6228	297	75	PE71S6351	291	61

PART NUMBER INDEX

Note: C/R stands for the Column and/or Row location of the specific product on a given page.

Model No.	Page	C/R	Model No.	Page	C/R	Model No.	Page	C/R	Model No.	Page	C/R	Model No.	Page	C/R	Model No.	Page	C/R
PE7156410	292	91	PE8036	279	90	PE8703	274	11	PE83CR1008	191	60	PE86X1016	277	5	PE9099	40	C7
PE7158001	291	50	PE8704	280	13	PE8704	274	10	PE83CR1009	191	33	PE86X1017	277	10	PE9100	40	C6
PE7158002	291	51	PE8040	280	13	PE8705	274	6	PE83CR1010	191	62	PE86X1018	277	6	PE9101	27	C7
PE7159001	344	19	PE8044	280	98	PE8706	274	7	PE83CR1011	191	66	PE86X1019	277	11	PE9102	27	A6
PE7159002	344	20	PE8203	283	90	PE8707	274	13	PE83CR1012	191	68	PE86X1020	277	2	PE9103	31	A7
PE7159003	344	17	PE8210	84	56	PE8708	274	15	PE83CR1013	190	6	PE86X1021	277	3	PE9104	36	A6
PE7159004	344	18	PE8211	84	59	PE8709	274	14	PE83CR1014	190	1	PE86X1022	277	7	PE9105	34	B5
PE73SP1000	287	65	PE8212	84	58	PE8710	274	12	PE83CR1015	190	7	PE86X1023	277	8	PE9106	23	A4
PE73SP1001	287	74	PE8213	84	52	PE8711	274	17	PE83CR1016	190	2	PE86X1024	277	12	PE9108	39	E2
PE73SP1002	287	75	PE8214	84	55	PE8712	274	19	PE83CR1017	190	8	PE86X1025	277	16	PE9109	23	D5
PE73SP1003	287	76	PE8215	84	54	PE8713	274	20	PE83CR1018	190	3	PE86X1026	277	15	PE9111	29	D4
PE73SP1004	287	37	PE8216	84	49	PE8714	274	22	PE83CR1019	190	9	PE86X1027	277	17	PE9112	30	E5
PE73SP1005	287	40	PE8217	84	51	PE8715	275	43	PE83CR1020	190	4	PE86X1028	277	22	PE9113	29	C4
PE73SP1006	287	41	PE8218	84	50	PE8716	275	42	PE83CR1021	190	10	PE86X1029	277	24	PE9114	42	E2
PE73SP1007	287	42	PE8219	84	60	PE8717	275	41	PE83CR1022	190	5	PE86X1030	277	27	PE9115	38	D7
PE73SP1008	287	45	PE8220	84	63	PE8718	275	44	PE83CR1023	190	11	PE86X1031	277	30	PE9116	30	D4
PE73SP1009	287	39	PE8221	84	62	PE8719	275	48	PE83CR1024	190	12	PE86X1032	277	33	PE9117	38	E6
PE73SP1010	287	83	PE8222	84	43	PE8720	275	53	PE83CR1025	190	13	PE86X1033	277	34	PE9118	38	D3
PE73SP1011	287	68	PE8223	84	45	PE8721	275	54	PE83CR1026	191	63	PE86X1034	277	35	PE9119	38	B7
PE73SP1012	287	69	PE8224	84	44	PE8722	275	49	PE83CR1027	190	14	PE86X1035	277	36	PE9120	38	A4
PE73SP1013	287	58	PE8225	84	46	PE8723	275	47	PE83CR1028	190	15	PE86X1036	277	37	PE9122	38	A5
PE73SP1014	287	87	PE8226	84	48	PE8724	275	50	PE83CR1029	190	17	PE86X1037	277	38	PE9123	29	B6
PE73SP1015	287	47	PE8227	84	47	PE8725	275	55	PE83CR1030	190	50	PE86X1038	277	39	PE9125	28	E7
PE73SP1016	287	59	PE8228	84	64	PE8726	275	61	PE83CR1031	190	29	PE86X1039	277	41	PE9126	38	E2
PE73SP1017	287	64	PE8229	84	66	PE8727	275	52	PE83CR1032	190	16	PE86X1040	277	28	PE9127	28	A5
PE73SP1018	287	63	PE8230	84	65	PE8728	276	60	PE83CR1033	190	52	PE86X1041	277	30	PE9128	27	E7
PE73SP1019	287	53	PE8231	84	70	PE8729	276	61	PE83CR1034	190	56	PE86X1042	277	29	PE9129	25	C3
PE73SP1020	287	80	PE8232	84	71	PE8730	276	62	PE83R000	192	37	PE86X1043	277	31	PE9130	29	C4
PE73SP1021	287	57	PE8233	84	40	PE8731	276	63	PE83R001	192	41	PE86X1044	277	32	PE9131	30	E3
PE73SP1022	287	54	PE8234	84	42	PE8732	276	64	PE83R002	192	13	PE86X1045	277	35	PE9132	38	A6
PE73SP1023	287	88	PE8235	84	41	PE8733	276	65	PE83R003	192	29	PE86X1046	277	34	PE9133	38	D6
PE73SP1024	287	86	PE8236	84	67	PE8734	276	66	PE83R004	192	18	PE86X1047	277	33	PE9134	38	B6
PE73SP1025	287	78	PE8237	84	69	PE8735	276	67	PE83R005	192	20	PE86X1048	277	37	PE9137	38	D5
PE73SP1026	287	62	PE8238	84	68	PE8736	276	68	PE83R006	192	28	PE86X1049	277	38	PE9138	39	C2
PE73SP1027	287	55	PE8239	283	96	PE8737	276	69	PE83R007	192	11	PE86X1050	277	39	PE9139	39	D1
PE73SP1028	287	81	PE8240	283	97	PE8738	276	71	PE83R008	192	15	PE86X1051	277	40	PE9140	39	A2
PE73SP1029	287	89	PE8241	283	98	PE8739	276	72	PE83R009	192	97	PE86X1052	277	41	PE9141	39	E1
PE73SP1030	287	43	PE8242	283	99	PE8740	276	73	PE83R010	192	10	PE86X1053	277	42	PE9142	39	B2
PE73SP1031	287	69	PE8243	283	98	PE8741	276	74	PE83R011	192	25	PE86X1054	277	43	PE9143	39	E2
PE73SP1032	287	83	PE8244	283	99	PE8742	276	75	PE83R012	192	99	PE86X1055	277	44	PE9144	39	A6
PE73SP1033	287	43	PE8245	283	99	PE8743	276	76	PE83R013	192	21	PE86X1056	277	45	PE9145	39	E2
PE73SP1034	287	43	PE8246	283	99	PE8744	276	77	PE83R014	192	21	PE86X1057	277	46	PE9146	37	A7
PE73SP1035	287	61	PE8247	283	99	PE8745	276	78	PE83R015	192	2	PE86X1058	277	47	PE9147	37	E1
PE73SP1036	287	79	PE8248	283	99	PE8746	276	79	PE83R016	192	2	PE86X1059	277	48	PE9148	34	C6
PE73SP1037	287	36	PE8249	283	99	PE8747	276	80	PE83R017	192	44	PE86X1060	277	49	PE9149	34	D6
PE73SP1038	287	52	PE8250	283	99	PE8748	276	81	PE83R018	192	68	PE86X1061	277	50	PE9150	34	C2
PE73SP1039	287	51	PE8251	283	99	PE8749	276	82	PE83R019	192	74	PE86X1062	277	51	PE9151	23	E7
PE73SP1040	287	46	PE8252	283	99	PE8750	276	83	PE83R020	192	69	PE86X1063	277	52	PE9152	23	A3
PE73SP1041	287	72	PE8253	283	99	PE8751	276	84	PE83R021	192	75	PE86X1064	277	53	PE9153	24	A1
PE73SP1042	274	3	PE8254	283	99	PE8752	276	85	PE83R022	192	70	PE86X1065	277	54	PE9154	25	E2
PE73SP1043	274	4	PE8255	283	99	PE8753	276	86	PE83R023	192	76	PE86X1066	277	55	PE9155	28	A7
PE73SP1044	274	1	PE8256	283	99	PE8754	276	87	PE83R024	192	71	PE86X1067	277	56	PE9156	28	A7
PE73SP1045	274	2	PE8257	283	99	PE8755	276	88	PE83R025	192	77	PE86X1068	277	57	PE9157	28	A7
PE73SP1046	274	2	PE8258	283	99	PE8756	276	89	PE83R026	192	79	PE86X1069	277	58	PE9158	28	A7
PE73SP1047	274	2	PE8259	283	99	PE8757	276	90	PE83R027	192	79	PE86X1070	277	59	PE9159	29	A1
PE73SP1048	274	71	PE8260	283	99	PE8758	276	91	PE83R028	192	79	PE86X1071	277	60	PE9160	29	A1
PE73SP1049	274	71	PE8261	283	99	PE8759	276	92	PE83R029	192	72	PE86X1072	277	61	PE9161	43	D3
PE73SP1050	287	70	PE8262	283	99	PE8760	276	93	PE83R030	192	78	PE86X1073	277	62	PE9162	43	D3
PE73SP1051	287	32	PE8263	283	99	PE8761	276	94	PE83R031	192	80	PE86X1074	277	63	PE9163	43	D3
PE73SP1052	287	35	PE8264	283	99	PE8762	276	95	PE83R032	192	81	PE86X1075	277	64	PE9164	43	D3
PE73SP1053	287	33	PE8265	283	99	PE8763	276	96	PE83R033	192	80	PE86X1076	277	65	PE9165	42	D4
PE73SP1054	287	34	PE8266	283	99	PE8764	276	97	PE83R034	192	81	PE86X1077	277	66	PE9166	43	A7
PE73SP1055	287	44	PE8267	283	99	PE8765	276	98	PE83R035	192	81	PE86X1078	277	67	PE9167	43	A7
PE73SP1056	287	86	PE8268	283	99	PE8766	276	99	PE83R036	192	82	PE86X1079	277	68	PE9168	29	C5
PE73SP1057	287	86	PE8269	283	99	PE8767	276	100	PE83R037	192	82	PE86X1080	277	69	PE9169	29	C5
PE73SP1058	287	84	PE8270	283	99	PE8768	276	101	PE83R038	192	82	PE86X1081	277	70	PE9170	29	C5
PE73SP1059	287	84	PE8271	283	99	PE8769	276	102	PE83R039	192	82	PE86X1082	277	71	PE9171	29	C5
PE73SP1060	287	84	PE8272	283	99	PE8770	276	103	PE83R040	192	82	PE86X1083	277	72	PE9172	29	C5
PE73SP1061	287	84	PE8273	283	99	PE8771	276	104	PE83R041	192	82	PE86X1084	277	73	PE9173	29	C5
PE73SP1062	287	84	PE8274	283	99	PE8772	276	105	PE83R042	192	82	PE86X1085	277	74	PE9174	29	C5
PE73SP1063	287	84	PE8275	283	99	PE8773	276	106	PE83R043	192	82	PE86X1086	277	75	PE9175	29	C5
PE73SP1064	287	84	PE8276	283	99	PE8774	276	107	PE83R044	192	82	PE86X1087	277	76	PE9176	29	C5
PE73SP1065	287	84	PE8277	283	99	PE8775	276	108	PE83R045	192	82	PE86X1088	277	77	PE9177	29	C5
PE73SP1066	287	84	PE8278	283	99	PE8776	276	109	PE83R046	192	82	PE86X1089	277	78	PE9178	29	C5
PE73SP1067	287	84	PE8279	283	99	PE8777	276	110	PE83R047	192	82	PE86X1090	277	79	PE9179	29	C5
PE73SP1068	287	84	PE8280	283													

PART NUMBER INDEX

Note: C/R stands for the Column and/or Row location of the specific product on a given page.

Model No.	Page	C/R	Model No.	Page	C/R	Model No.	Page	C/R	Model No.	Page	C/R	Model No.	Page	C/R	Model No.	Page	C/R
PE9375	45	B5	PE9512	37	C2	PE9645	17	E4	PE9786	26	B7	PE9860/NF-20	324	53	PE91054	37	D1
PE9376	45	E4	PE9513	37	B1	PE9647	17	D5	PE9787	26	E1	PE9860/SF-20	324	56	PE91055	37	D1
PE9377	45	A5	PE9514	26	D7	PE9648	17	A6	PE9801	330	34	PE9860-20	324	43	PE91056	37	D1
PE9378	45	C5	PE9517	26	D6	PE9649	19	C1	PE9802	330	45	PE9861/NF-10	324	57	PE91057	37	C3
PE9379	31	B6	PE9518	26	C7	PE9650	19	A3	PE9803	329	98	PE9861/SF-10	324	60	PE91058	37	E1
PE9380	32	D3	PE9519	26	E6	PE9651	19	D1	PE9804	330	36	PE9861-10	324	44	PE91059	37	E3
PE9382	28	D2	PE9520	25	B7	PE9652	19	C3	PE9805	330	42	PE9861/NF-15	324	58	PE91060	18	E5
PE9383	28	A1	PE9521	41	D7	PE9653	33	B5	PE9806	329	99	PE9861-SF	324	61	PE91061	37	C3
PE9384	25	B3	PE9522	26	B6	PE9654	33	C5	PE9809	329	90	PE9861-15	324	65	PE91062	35	A1
PE9385	30	A6	PE9523	26	A6	PE9655	35	D4	PE9810	330	37	PE9861/NF-20	324	59	PE91063	34	C7
PE9386	25	A3	PE9524	25	E5	PE9656	35	E4	PE9811	330	44	PE9861/SF-20	324	62	PE91064	37	B4
PE9387	25	E3	PE9525	26	B7	PE9658	19	E1	PE9812	329	85	PE9861-20	324	66	PE91065	39	D5
PE9388	28	B6	PE9526	27	A1	PE9659	19	D3	PE9813A	329	84	PE9862/NF-15	324	63	PE91066	37	E2
PE9389	29	E7	PE9527	26	A7	PE9660	18	A4	PE9819	330	13	PE9862/SF-15	324	65	PE91068	39	A4
PE9390	27	C3	PE9528	26	E7	PE9661	18	A2	PE9820	330	61	PE9862-15	324	68	PE91069	26	A3
PE9391	43	B6	PE9529	23	D4	PE9662	18	B2	PE9821	331	86	PE9862/NF-20	324	64	PE91070	17	D7
PE9392	40	C2	PE9530	23	C4	PE9663	18	C5	PE9822	331	96	PE9862-SF-20	324	66	PE91072	39	B4
PE9393	40	A2	PE9531	41	D2	PE9664	18	D5	PE9823	331	2	PE9862-20	324	69	PE91073	42	A1
PE9394	40	D2	PE9532	41	C2	PE9665	18	C2	PE9824	331	11	PE9863/NF-10	325	69	PE91080	45	E3
PE9395	40	B2	PE9533	32	D7	PE9666	17	D6	PE9826	329	72	PE9863/SF-10	325	71	PE91081	45	D3
PE9396	44	A1	PE9534	32	B7	PE9667	17	C6	PE9827	329	75	PE9863-10	326	50	PE91082	45	C4
PE9397	44	C3	PE9535	28	C4	PE9668	18	D2	PE9828	329	88	PE9863-NF-20	325	70	PE91083	45	B4
PE9398	25	C4	PE9536	23	C5	PE9669	31	E6	PE9830	331	79	PE9863/SF-20	325	72	PE91084	16	E3
PE9399	35	C3	PE9537	23	C7	PE9670	18	C5	PE9831	331	97	PE9864-20	325	73	PE91085	47	E7
PE9400	35	E4	PE9538	28	C6	PE9672	16	C7	PE9832	331	96	PE9864/NF-10	325	74	PE91086	16	C3
PE9401	35	E1	PE9539	29	D7	PE9673	17	B2	PE9833	331	3	PE9864/SF-10	325	77	PE91087	42	D1
PE9402	37	A5	PE9540	29	D7	PE9674	16	D7	PE9834	331	6	PE9864-10	326	53	PE91088	21	E4
PE9403	31	E1	PE9541	28	B1	PE9675	17	C2	PE9835	331	20	PE9864/NF-15	325	75	PE91089	21	C5
PE9404	31	D2	PE9542	41	B5	PE9676	18	C7	PE9837	331	60	PE9864/SF-15	325	78	PE91090	21	E7
PE9405	31	B2	PE9543	41	A5	PE9678	18	B7	PE9838	331	80	PE9864-15	326	54	PE91091	22	C1
PE9406	31	E4	PE9544	41	C7	PE9680	18	C5	PE9839	331	97	PE9864-NF-20	325	79	PE91092	22	E7
PE9407	35	E7	PE9545	41	B7	PE9682	33	E3	PE9840	331	97	PE9864/SF-20	325	79	PE91093	20	C1
PE9408	36	E6	PE9546	31	B7	PE9683	33	A4	PE9842	331	12	PE9864-20	326	55	PE91094	20	A2
PE9409	21	A3	PE9547	27	E4	PE9684	36	E4	PE9843	331	21	PE9865	330	64	PE91095	20	D2
PE9411	33	E6	PE9548	27	D7	PE9685	39	C6	PE9846	329	3	PE9866	329	1	PE91099	39	C4
PE9413	25	B5	PE9550	29	B4	PE9687	24	E3	PE9847	330	15	PE9867	330	14	PE91101	39	D4
PE9414	21	D3	PE9551	36	A5	PE9688	24	D3	PE9848	330	38	PE9868	330	23	PE91102	39	D3
PE9415	37	A7	PE9552	30	B6	PE9689	24	A4	PE9850ZF-10	324	10	PE9869	330	39	PE91103	34	B3
PE9416	43	A7	PE9553	30	D1	PE9690	35	D3	PE9850-20	325	10	PE9870	330	62	PE91104	33	E6
PE9417	43	E6	PE9554	28	D7	PE9691	35	E3	PE9850ZF-15	324	11	PE9871	330	47	PE91105	45	E7
PE9418	31	A6	PE9555	25	B3	PE9692	33	C4	PE9851	325	11	PE9872	331	19	PE91106	45	C7
PE9419	25	D4	PE9556	21	B3	PE9693	35	A4	PE9852ZF-20	324	3	PE9873	330	33	PE91107	45	D7
PE9420	23	C3	PE9557	21	B2	PE9694	31	C7	PE9850-20	325	12	PE9874	330	12	PE91108	16	B2
PE9421	42	C4	PE9558	21	B6	PE9695	32	A4	PE9851ZF-10	324	4	PE9875	329	2	PE91109	16	D2
PE9422	28	D1	PE9559	22	A3	PE9696	24	C4	PE9851ZF-15	324	13	PE9876	331	78	PE91113	17	E5
PE9423	34	D4	PE9560	24	E4	PE9697	24	A5	PE9851-SF-15	324	13	PE9877	331	4	PE91114	17	A1
PE9424	36	E5	PE9561	40	B6	PE9698	24	A5	PE9851ZF-20	324	6	PE9878	329	83	PE91115	16	A4
PE9433	34	E4	PE9562	41	A4	PE9699	41	B4	PE9851A-15	324	14	PE9879	329	89	PE91117	21	A2
PE9434	36	D6	PE9563	41	E4	PE9700	41	C4	PE9851A-20	324	15	PE9881	6	5	PE91118	16	A2
PE9435	36	A7	PE9564	41	E6	PE9701	42	E3	PE9852ZF-10	324	7	PE9881A-20	329	54	PE91119	16	C2
PE9436	17	D4	PE9565	28	C5	PE9703	36	C1	PE9852-10	324	16	PE9882	Web	Web	PE91120	17	D1
PE9437	17	A5	PE9566	29	A6	PE9704	28	B7	PE9852ZF-15	324	8	PE9883	330	32	PE91121	17	C1
PE9438	17	C5	PE9567	25	B2	PE9705	28	B7	PE9852ZF-20	324	6	PE9884	330	64	PE91122	17	A1
PE9439	35	B2	PE9568	31	B3	PE9706	36	E4	PE9852A-15	325	17	PE9881-11	Web	Web	PE91123	17	E2
PE9440	37	E5	PE9569	25	B4	PE9707	34	A1	PE9852-20	325	18	PE9887	329	51	PE91124	18	C1
PE9441	Web	Web	PE9570	29	A2	PE9708	36	D1	PE9853/SF-10	324	11	PE9888-11	Web	Web	PE91125	18	D1
PE9442	37	B6	PE9571	31	D3	PE9709	26	A5	PE9853-10	325	19	PE9889	330	35	PE91126	18	E1
PE9443	40	A6	PE9572	31	A2	PE9710	26	C5	PE9853/SF-15	324	12	PE9890	330	46	PE91127	18	E4
PE9444	40	E7	PE9573	31	E2	PE9711	24	B5	PE9853-15	325	20	PE9890	Web	Web	PE91128	18	A5
PE9445	40	D4	PE9574	24	C5	PE9712	24	C5	PE9853A-20	324	13	PE9891	Web	Web	PE91129	36	A3
PE9446	40	D3	PE9575	25	B1	PE9713	24	C7	PE9853ZF-10	324	13	PE9911	Web	Web	PE91134	34	E4
PE9448	29	A4	PE9576	24	D7	PE9714	41	A7	PE9854/NF-10	324	14	PE9912	Web	Web	PE91135	31	B5
PE9449	30	A5	PE9577	24	C7	PE9715	16	D3	PE9854/SF-10	324	17	PE9913	Web	Web	PE91136	Web	Web
PE9450	30	D5	PE9578	25	A1	PE9716	16	B3	PE9854-10	325	22	PE9914	Web	Web	PE91138	Web	Web
PE9451	16	B6	PE9579	25	D2	PE9718	16	E4	PE9854/NF-10	324	15	PE9915	Web	Web	PE91140	27	E6
PE9452	16	C6	PE9580	25	C1	PE9719	16	A5	PE9854/SF-15	324	18	PE9916	Web	Web	PE91141	27	A7
PE9453	16	D6	PE9581	37	D7	PE9720	16	D5	PE9854-15	325	23	PE9917	Web	E2	PE91144	42	B5
PE9454	17	C7	PE9582	44	A2	PE9721	33	A6	PE9854ZF-10	324	19	PE9918	Web	Web	PE91145	17	B4
PE9455	17	C7	PE9583	44	A4	PE9722	33	A6	PE9854/SF-20	324	19	PE9919	Web	Web	PE91146	17	B4
PE9456	18	D3	PE9584	44	E1	PE9723	Web	Web	PE9854-20	325	24	PE9951	Web	Web	PE91147	19	E4
PE9457	17	A7	PE9585	44	C4	PE9724	35	C5	PE9855/NF-10	324	20	PE9952	Web	Web	PE91148	19	D4
PE9458	17	B1	PE9586	44	C2	PE9725	35	D5	PE9855/SF-10	324	23	PE9953	Web	Web	PE91149	32	B2
PE9459	Web	Web	PE9587	44	A5	PE9726	35	B4	PE9855-10	326	25	PE9954	Web	Web	PE91150	Web	Web
PE9460	18	B1	PE9588	44	B2	PE9727	33	E4	PE9855/NF-15	324	21	PE9955	Web	Web	PE91151	31	C6
PE9461	18	D1	PE9589	44	E4	PE9728	33	E4	PE9855-15	324	22	PE9956	Web	Web	PE91152	31	C6
PE9462	30	C2	PE9590	33	A3	PE9729	35	C4	PE9855-20	324	26	PE9957	Web	Web	PE91155	32	B1
PE9463	30	B2	PE9594	33	C2	PE9730	30	C6	PE9855/NF-20	324	22	PE9958	Web	Web	PE91159	16	B5
PE9464	29	C1	PE9595	27	D5	PE9731	30	D6	PE9855/SF-20	324	25	PE9959	Web	Web	PE91161	16	C4
PE9465	29	B1	PE9596	38	E1	PE9732	38	C1	PE9855A-20	324	27	PE9960	Web	Web	PE91162	16	C5
PE9466	25	A7	PE9597	38	D1	PE9733	38	A2	PE9856/NF-10	324	27	PE9961	Web	Web	PE91163	Web	Web
PE9467	25	D6	PE9598	38	B2												

PART NUMBER INDEX

Note: C/R stands for the Column and/or Row location of the specific product on a given page.

Model No.	Page	C/R	Model No.	Page	C/R	Model No.	Page	C/R	Model No.	Page	C/R	Model No.	Page	C/R	Model No.	Page	C/R			
PE91407	Web		PEW125010-9	345	57	PEWAN1041	326	80	PEWCA1029	329	5	PEWCP1059	336	91	PEWCT1096	338	3	PEWR1015	342	89
PE91408	Web		PEW1252P4	348	47	PEWAN1042	326	81	PEWCA1030	330	28	PEWCP1060	336	92	PEWCT1097	338	7	PEWMT1000	343	97
PE91410	Web		PEW137E5J	348	13	PEWAN1043	327	82	PEWCA1031	330	29	PEWCP1061	336	93	PEWCT1098	338	11	PEWMT1001	343	88
PE91411	Web		PEW137SP7	349	97	PEWAN1044	327	83	PEWCA1032	330	17	PEWCP1062	336	97	PEWCT1099	338	15	PEWMT1002	343	99
PE91412	Web		PEW159F57	349	98	PEWAN1045	326	76	PEWCA1033	330	16	PEWCP1063	336	98	PEWCT1100	338	16	PEWMT1003	343	1
PE91413	Web		PEW159P7	349	99	PEWAN1046	326	77	PEWCA1034	330	22	PEWCP1064	336	1	PEWCT1101	338	20	PEWMT1004	343	2
PE91414	Web		PEW15F52	348	48	PEWAN1047	326	78	PEWCA1035	330	20	PEWCP1065	336	3	PEWCT1102	338	24	PEWMT1005	343	3
PE91415	Web		PEW15S010-12	345	62	PEWAN1048	326	79	PEWCA1036	330	19	PEWCP1066	336	5	PEWCT1103	338	28	PEWMT1006	343	4
PE91416	Web		PEW15T18R0001	346	49	PEWAN1049	326	68	PEWCA1037	330	43	PEWCP1067	336	99	PEWCT1104	338	17	PEWMT1007	343	6
PE91417	Web		PEW15T18R0001	346	35	PEWAN1050	326	69	PEWCA1038	330	40	PEWCP1068	336	2	PEWCT1105	338	19	PEWMT1008	343	7
PE91418	Web		PEW187F57	349	1	PEWAN1051	326	70	PEWCA1039	330	41	PEWCP1069	336	4	PEWCT1106	338	25	PEWMT1009	343	8
PE91419	Web		PEW187SP7	349	2	PEWAN1052	326	71	PEWCA1040	330	56	PEWCP1070	336	6	PEWCT1107	338	29	PEWMT1010	343	9
PE91420	Web		PEW19F53	348	50	PEWAN1053	326	72	PEWCA1041	330	54	PEWCP1071	336	7	PEWCT1108	338	18	PEWMT1011	343	5
PE91421	Web		PEW19S010-12	345	68	PEWAN1054	326	73	PEWCA1042	330	49	PEWCP1072	336	9	PEWCT1109	338	22	PEWMT1012	343	6
PE91422	Web		PEW19S010-12	345	68	PEWAN1055	326	74	PEWCA1043	330	48	PEWCP1073	336	11	PEWCT1110	338	26	PEWMT1013	343	22
PE91423	Web		PEW19S010-3	345	67	PEWAN1056	326	75	PEWCA1044	330	53	PEWCP1074	336	13	PEWCT1111	338	30	PEWMT1014	343	23
PE91424	Web		PEW19SP4	349	51	PEWAN1057	326	64	PEWCA1045	330	51	PEWCP1075	336	10	PEWCT1112	338	19	PEWMT1015	343	24
PE91425	C3		PEW22W18R0001	346	39	PEWAN1058	326	65	PEWCA1046	330	55	PEWCP1076	336	10	PEWCT1113	338	23	PEWMT1016	343	25
PE91426	A3		PEW22B100	332	56	PEWAN1059	326	66	PEWCA1047	330	73	PEWCP1077	336	12	PEWCT1114	338	27	PEWMT1017	343	26
PE91427	A3		PEW22B101	332	57	PEWAN1060	326	67	PEWCA1048	330	66	PEWCP1078	336	14	PEWCT1115	338	31	PEWMT1018	343	27
PE91428	A3		PEW22CA100	329	67	PEWAN1061	326	60	PEWCA1049	330	65	PEWCR1000	Web		PEWCT1116	338	32	PEWMT1019	343	28
PE91429	B7		PEW22CP010-20	334	28	PEWAN1062	326	61	PEWCA1050	330	70	PEWCR1001	Web		PEWCT1117	338	33	PEWMT1020	343	29
PE91430	E4		PEW22F53	349	52	PEWAN1063	326	62	PEWCA1051	330	68	PEWCR1002	Web		PEWCT1118	338	34	PEWMT1021	343	30
PE91431	E4		PEW22S010-3	345	73	PEWAN1064	326	63	PEWCA1052	330	82	PEWCR1003	Web		PEWCT1119	338	35	PEWMT1022	343	31
PE91432	C1		PEW22W18R0001	346	39	PEWAN1065	326	64	PEWCA1053	330	78	PEWCR1004	Web		PEWCT1120	338	36	PEWMT1023	343	32
PE91433	B3		PEW22W18R0001	346	39	PEWAN1066	326	65	PEWCA1054	330	84	PEWCR1005	Web		PEWCT1121	338	37	PEWMT1024	343	33
PE91434	A3		PEW22B100	332	56	PEWAN1067	326	58	PEWCA1055	330	83	PEWCR1006	Web		PEWCT1122	338	38	PEWMT1025	343	34
PE91435	A3		PEW22B101	332	57	PEWAN1068	326	59	PEWCA1056	330	93	PEWCT1000	336	15	PEWCT1001	336	16	PEWMT1026	343	35
PE91436	A3		PEW22CA100	329	67	PEWAN1069	327	2	PEWCA1057	330	90	PEWCT1002	336	17	PEWCT1003	336	18	PEWMT1027	343	36
PE91437	B7		PEW22CP010-20	334	28	PEWAN1070	327	3	PEWCA1058	330	89	PEWCT1004	336	19	PEWCT1005	336	20	PEWMT1028	343	37
PE91438	E4		PEW22F53	349	52	PEWAN1071	327	97	PEWCA1059	330	91	PEWCT1006	336	22	PEWCT1007	336	23	PEWMT1029	343	38
PE91439	E4		PEW22S010-3	345	73	PEWAN1072	327	98	PEWCA1060	330	92	PEWCT1008	336	24	PEWCT1009	336	25	PEWMT1030	343	39
PE91440	C3		PEW22W18R0001	346	39	PEWAN1073	327	93	PEWCA1061	330	1	PEWCT1010	336	26	PEWCT1011	336	27	PEWMT1031	343	40
PE91441	B3		PEW22B100	332	56	PEWAN1074	327	94	PEWCA1062	330	1	PEWCT1012	336	28	PEWCT1013	336	29	PEWMT1032	343	41
PE91442	A3		PEW22B101	332	57	PEWAN1075	327	94	PEWCA1063	330	1	PEWCT1014	336	30	PEWCT1015	336	31	PEWMT1033	343	42
PE91443	A3		PEW22CA100	329	67	PEWAN1076	327	19	PEWCA1064	330	5	PEWCT1016	336	32	PEWCT1017	336	32	PEWMT1034	343	43
PE91444	B7		PEW22CP010-20	334	28	PEWAN1077	327	18	PEWCA1065	330	7	PEWCT1018	336	33	PEWCT1019	336	33	PEWMT1035	343	44
PE91445	E4		PEW22F53	349	52	PEWAN1078	327	20	PEWCA1066	330	13	PEWCT1020	336	34	PEWCT1021	336	34	PEWMT1036	343	45
PE91446	E4		PEW22S010-3	345	73	PEWAN1079	327	13	PEWCA1067	330	14	PEWCT1022	336	35	PEWCT1023	336	35	PEWMT1037	343	46
PE91447	C1		PEW22W18R0001	346	39	PEWAN1080	327	15	PEWCA1068	330	20	PEWCT1024	336	36	PEWCT1025	336	36	PEWMT1038	343	47
PE91448	B3		PEW22B100	332	56	PEWAN1081	327	14	PEWCA1069	330	16	PEWCT1026	336	37	PEWCT1027	336	37	PEWMT1039	343	48
PE91449	A3		PEW22B101	332	57	PEWAN1082	327	16	PEWCA1070	330	16	PEWCT1028	336	38	PEWCT1029	336	38	PEWMT1040	343	49
PE91450	A3		PEW22CA100	329	67	PEWAN1083	327	8	PEWCA1071	330	97	PEWCT1030	336	39	PEWCT1031	336	39	PEWMT1041	343	50
PE91451	B7		PEW22CP010-20	334	28	PEWAN1084	327	10	PEWCA1072	330	96	PEWCT1032	336	40	PEWCT1033	336	40	PEWMT1042	343	51
PE91452	E4		PEW22F53	349	52	PEWAN1085	327	9	PEWCA1073	330	11	PEWCT1034	336	41	PEWCT1035	336	41	PEWMT1043	343	52
PE91453	E4		PEW22S010-3	345	73	PEWAN1086	327	11	PEWCA1074	330	10	PEWCT1036	336	42	PEWCT1037	336	42	PEWMT1044	343	53
PE91454	C3		PEW22W18R0001	346	39	PEWAN1087	327	49	PEWCA1075	330	20	PEWCT1038	336	43	PEWCT1039	336	43	PEWMT1045	343	54
PE91455	B3		PEW22B100	332	56	PEWAN1088	328	24	PEWCA1076	330	20	PEWCT1040	336	44	PEWCT1041	336	44	PEWMT1046	343	55
PE91456	A3		PEW22B101	332	57	PEWAN1089	328	23	PEWCA1077	330	17	PEWCT1042	336	45	PEWCT1043	336	45	PEWMT1047	343	56
PE91457	A3		PEW22CA100	329	67	PEWAN1090	327	12	PEWCA1078	330	68	PEWCT1044	336	46	PEWCT1045	336	46	PEWMT1048	343	57
PE91458	B7		PEW22CP010-20	334	28	PEWAN1091	327	92	PEWCA1079	330	17	PEWCT1046	336	47	PEWCT1047	336	47	PEWMT1049	343	58
PE91459	E4		PEW22F53	349	52	PEWAN1100	327	7	PEWCA1080	330	18	PEWCT1048	336	48	PEWCT1049	336	48	PEWMT1050	343	59
PE91460	E4		PEW22S010-3	345	73	PEWAN1101	327	7	PEWCA1081	330	10	PEWCT1050	336	49	PEWCT1051	336	49	PEWMT1051	343	60
PE91461	C3		PEW22W18R0001	346	39	PEWAN1102	327	49	PEWCA1082	330	94	PEWCT1052	336	50	PEWCT1053	336	50	PEWMT1052	343	61
PE91462	B3		PEW22B100	332	56	PEWAN1103	327	6	PEWCA1083	330	85	PEWCT1054	336	51	PEWCT1055	336	51	PEWMT1053	343	62
PE91463	A3		PEW22B101	332	57	PEWAN1104	327	5	PEWCA1084	330	76	PEWCT1056	336	52	PEWCT1057	336	52	PEWMT1054	343	63
PE91464	A3		PEW22CA100	329	67	PEWAN1105	327	4	PEWCA1085	330	71	PEWCT1058	336	53	PEWCT1059	336	53	PEWMT1055	343	64
PE91465	B7		PEW22CP010-20	334	28	PEWAN1106	328	46	PEWCA1086	330	76	PEWCT1060	336	54	PEWCT1061	336	54	PEWMT1056	343	65
PE91466	E4		PEW22F53	349	52	PEWAN1107	328	45	PEWCA1087	330	71	PEWCT1062	336	55	PEWCT1063	336	55	PEWMT1057	343	66
PE91467	E4		PEW22S010-3	345	73	PEWAN1108	327	1	PEWCA1088	330	77	PEWCT1064	336	56	PEWCT1065	336	56	PEWMT1058	343	67
PE91468	C1		PEW22W18R0001	346	39	PEWAN1109	327	92	PEWCA1089	330	58	PEWCT1066	336	57	PEWCT1067	336	57	PEWMT1059	343	68
PE91469	B3		PEW22B100	332	56	PEWAN1110	327	1	PEWCA1090	330	59	PEWCT1068	336	58	PEWCT1069	336	58	PEWMT1060	343	69
PE91470	A3		PEW22B101	332	57	PEWAN1111	328	50	PEWCA1091	330	59	PEWCT1070	336	59	PEWCT1071	336	59	PEWMT1061	343	70
PE91471	A3		PEW22CA100	329	67	PEWAN1112	328	49	PEWCA1092	330	31	PEWCT1072	336	60	PEWCT1073	336	60	PEWMT1062	343	71
PE91472	B7		PEW22CP010-20	334	28	PEWAN1113	327	6</												

50-OHM CONVERSION TABLE (dBm - volts- watts)

dBm	V	Po
+53	100.0	200W
+50	70.7	100W
+49	64.0	80W
+48	58.0	64W
+47	50.0	50W
+46	44.5	40W
+45	40.0	32W
+44	32.5	25W
+43	32.0	20W
+42	28.0	16W
+41	26.2	12.5W
+40	22.5	10W
+39	20.0	8W
+38	18.0	6.4W
+37	16.0	5W
+36	14.1	4W
+35	12.5	3.2W
+34	11.5	2.5W
+33	10.0	2W
+32	9.0	1.6W
+31	8.0	1.25W
+30	7.10	1.0W
+29	6.40	800 mW
+28	5.80	640 mW
+27	5.00	500 mW
+26	4.45	400 mW
+25	4.00	320 mW
+24	3.55	250 mW
+23	3.20	200 mW
+22	2.80	160 mW
+21	2.52	125 mW
+20	2.25	100 mW
+19	2.00	80 mW
+18	1.80	64 mW
+17	1.60	50 mW
+16	1.41	40 mW
+15	1.25	32 mW
+14	1.15	25 mW
+13	1.00	20 mW
+12	0.90	16 mW
+11	0.80	12.5 mW
+10	0.71	10 mW
+9	0.64	8 mW
+8	0.58	6.4 mW
+7	0.50	5 mW
+6	0.45	4 mW
+5	0.40	3.2 mW
+4	0.36	2.5 mW
+3	0.32	2.0 mW

dBm	V	Po
+2	0.28	1.6 mW
+1	0.25	1.25 mW
0	0.23	1.0 mW
-1	0.20	.80 mW
-2	0.18	.64 mW
-3	0.16	.50 mW
-4	0.14	.40 mW
-5	0.13	.32 mW
-6	0.12	.25 mW
-7	0.10	.20 mW
-8	0.09	.16 mW
-9	0.08	.125 mW
-10	0.07	.10 mW
-11	0.06	
-12	0.06	
-13	0.05	
-14	0.05	
-15	0.04	
-16	0.0355	
dBm	mV	Po
-17	31.5	
-18	28.5	
-19	25.1	
-20	22.5	.01 mW
-21	20.0	
-22	17.9	
-23	15.9	
-24	14.1	
-25	12.8	
-26	11.5	
-27	10.0	
-28	8.9	
-29	8.0	
-30	7.1	.001 mW
-31	6.25	
-32	5.8	
-33	5.0	
-34	4.5	
-35	4.0	
-36	3.5	
-37	3.2	
-38	2.85	
-39	2.5	
-40	2.25	.1 μW
-41	2.0	
-42	1.8	
-43	1.6	
-44	1.4	
-45	1.25	

dBm	mV	Po
-46	1.18	
-47	1.0	
-48	0.9	
-49	0.8	
-50	0.71	.01 μW
-51	0.64	
-52	0.57	
-53	0.5	
-54	0.45	
-55	0.4	
-56	0.351	
-57	0.32	
-58	0.286	
-59	0.251	
-60	0.225	.001 μW
-61	0.2	
-62	0.18	
-63	0.16	
-64	0.141	
dBm	μV	Po
-65	128	
-66	115	
-67	100	
-68	90	
-69	80	
-70	71	.1 nW
-71	65	
-72	58	
-73	50	
-74	45	
-75	40	
-76	35	
-77	32	
-78	29	
-79	25	
-80	22.5	.01 nW
-81	20	
-82	18	
-83	16	
-84	11.1	
-85	12.9	
-86	11.5	
-87	10.0	
-88	9.0	
-89	8.0	
-90	7.1	.001 nW
-91	6.1	
-92	5.75	
-93	5.0	

dBm	μV	Po
-94	4.5	
-95	4.0	
-96	3.51	
-97	3.2	
-98	2.9	
-99	2.51	
-100	2.25	.1 pW
-101	2.0	
-102	1.8	
-103	1.6	
-104	1.41	
-105	1.27	
-106	1.18	
dBm	nV	Po
-107	1000	
-108	900	
-109	800	
-110	710	.01 pW
-109	640	
-112	580	
-113	500	
-114	450	
-115	400	
-116	355	
-117	825	
-118	285	
-119	251	
-120	225	.001 pW
-121	200	
-122	180	
-123	160	
-124	141	
-125	128	
-126	117	
-127	100	
-128	90	
-129	80	
-130	71	.1 fW
-131	61	
-132	58	
-133	50	
-134	45	
-135	40	
-136	35	
-137	33	
-138	29	
-139	25	
-140	23	.01 fW

RETURN LOSS CONVERSION TABLE

Return Loss (dBm)	VSWR
46.064	1.01
40.086	1.02
36.607	1.03
34.151	1.04
32.256	1.05
30.714	1.06
29.417	1.07
28.299	1.08
27.318	1.09
26.444	1.10
25.658	1.11
24.943	1.12
24.289	1.13
23.686	1.14
23.127	1.15
22.607	1.16
22.120	1.17
21.664	1.18
21.234	1.19
20.828	1.20
20.443	1.21
20.079	1.22
19.732	1.23
19.401	1.24
19.085	1.25
18.783	1.26
18.493	1.27
18.216	1.28
17.949	1.29
17.690	1.30
17.445	1.31
17.207	1.32
16.977	1.33
16.755	1.34
16.540	1.35
16.332	1.36
16.131	1.37
15.936	1.38
15.747	1.39
15.563	1.40
15.385	1.41
15.211	1.42
15.043	1.43
14.879	1.44
14.719	1.45
14.564	1.46
14.412	1.47
14.264	1.48
14.120	1.49
13.979	1.50

Return Loss (dBm)	VSWR
13.842	1.51
13.708	1.52
13.577	1.53
13.449	1.54
13.324	1.55
13.201	1.56
13.081	1.57
12.964	1.58
12.849	1.59
12.736	1.60
12.625	1.61
12.518	1.62
12.412	1.63
12.308	1.64
12.207	1.65
12.107	1.66
12.009	1.67
11.913	1.68
11.818	1.69
11.725	1.70
11.634	1.71
11.545	1.72
11.457	1.73
11.370	1.74
11.285	1.75
11.202	1.76
11.120	1.77
11.039	1.78
10.960	1.79
10.881	1.80
10.804	1.81
10.729	1.82
10.654	1.83
10.581	1.84
10.509	1.85
10.437	1.86
10.367	1.87
10.298	1.88
10.230	1.89
10.163	1.90
10.097	1.91
10.032	1.92
9.968	1.93
9.904	1.94
9.842	1.95
9.780	1.96
9.720	1.97
9.660	1.98
9.601	1.99
9.542	2.00

Return Loss (dBm)	VSWR
9.485	2.01
9.428	2.02
9.372	2.03
9.317	2.04
9.262	2.05
9.208	2.06
9.155	2.07
9.103	2.08
9.051	2.09
8.999	2.10
8.949	2.11
8.899	2.12
8.849	2.13
8.800	2.14
8.752	2.15
8.705	2.16
8.657	2.17
8.611	2.18
8.565	2.19
8.519	2.20
8.474	2.21
8.430	2.22
8.386	2.23
8.342	2.24
8.299	2.25
8.257	2.26
8.215	2.27
8.173	2.28
8.138	2.29
8.091	2.30
8.051	2.31
8.011	2.32
7.972	2.33
7.933	2.34
7.894	2.35
7.856	2.36
7.818	2.37
7.781	2.38
7.744	2.39
7.707	2.40
7.671	2.41
7.635	2.42
7.599	2.43
7.564	2.44
7.529	2.45
7.494	2.46
7.460	2.47
7.426	2.48
7.393	2.49
7.360	2.50

Return Loss (dBm)	VSWR
7.327	2.51
7.294	2.52
7.262	2.53
7.230	2.54
7.198	2.55
7.167	2.56
7.135	2.57
7.105	2.58
7.074	2.59
7.044	2.60
7.014	2.61
6.984	2.62
6.954	2.63
6.925	2.64
6.896	2.65
6.867	2.66
6.839	2.67
6.811	2.68
6.783	2.69
6.755	2.70
6.728	2.71
6.700	2.72
6.673	2.73
6.646	2.74
6.620	2.75
6.594	2.76
6.567	2.77
6.541	2.78
6.516	2.79
6.490	2.80
6.465	2.81
6.440	2.82
6.415	2.83
6.390	2.84
6.366	2.85
6.341	2.86
6.317	2.87
6.293	2.88
6.270	2.89
6.246	2.90
6.223	2.91
6.200	2.92
6.177	2.93
6.154	2.94
6.131	2.95
6.109	2.96
6.086	2.97
6.064	2.98
6.042	2.99
6.021	3.00

Return Loss (dBm)	VSWR
5.999	3.01
5.970	3.02
5.956	3.03
5.935	3.04
5.914	3.05
5.893	3.06
5.872	3.07
5.852	3.08
5.832	3.09
5.811	3.10
5.791	3.11
5.771	3.12
5.751	3.13
5.732	3.14
5.712	3.15
5.693	3.16
5.674	3.17
5.654	3.18
5.635	3.19
5.617	3.20
5.598	3.21
5.579	3.22
5.561	3.23
5.542	3.24
5.524	3.25
5.506	3.26
5.488	3.27
5.470	3.28
5.452	3.29
5.435	3.30
5.417	3.31
5.400	3.32
5.383	3.33
5.365	3.34
5.348	3.35
5.331	3.36
5.315	3.37
5.298	3.38
5.281	3.39
5.265	3.40
5.248	3.41
5.232	3.42
5.216	3.43
5.200	3.44
5.184	3.45
5.168	3.46
5.152	3.47
5.137	3.48
5.121	3.49
5.105	3.50

MOUNTING HOLES

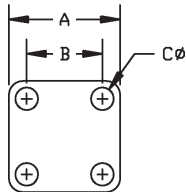

CODE	A	B	C
A01	.500	.340	.102
A02	.687	.500	.109
A03	.687	.500	#3-56 TAP
A04	.687	.500	.125
A05	1.000	.718	.125
A06	.750	.531	.140
A07	.750	.531	.125
A08	1.190	.906	.125
A09	.687	.500	#4-40 TAP
A10	.687	.500	.136
A11	1.250	.975	.147
A12	2.000	1.440	.257
A13	1.000	.718	.141
A14	1.000	.718	.144
A15	.687	.500	.104
A16	.750	.531	.136
A17	.375	.232	.067
A18	.625	.437	.094
A19	1.000	.718	#6-32 TAP
A20	.500	.340	#2-56 TAP
A21	1.250	.975	.142
A22	.375	.232	.093

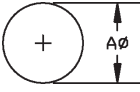

CODE	A
F01	.250
F02	.500
F03	.630
F04	1.200
F05	.380
F06	.450
F07	.200
F08	.362
F09	.220
F10	.317
F11	4.83mm
F12	.390

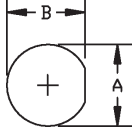

CODE	A	B
B01	.195	.177
B02	.250	.235
B03	.330	.295
B04	.380	.350
B05	.440	.410
B06	.512	.480
B07	.760	.720
B08	.565	.537
B09	.314	.296
B10	.140	.126
B11	.695	.655
B12	.625	.575
B13	.405	.361
B14	.277	.252
B15	.630	.596
B16	.317	.285
B17	.284	.268

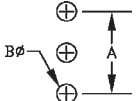

CODE	A	B
J01	.200	.046

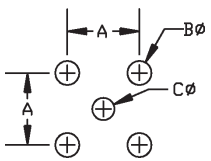

CODE	A	B	C
D01	.200	.067	.062
D02	.200	.067	.046
D03	.100	.031	.031
D04	.200	.052	.052
D05	.260	.067	.043
D06	.200	.052	.047
D07	.200	.055	.043
D08	.200	.067	.035
D09	.200	.055	.028
D10	.200	.055	.035
D11	.320	.091	.031
D12	.400	.062	.062
D13	.320	.091	.091
D14	.340	.091	.043
D15	.164	.067	.091
D16	.500	.126	.440
D17	.380	.083	.043

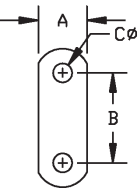

CODE	A	B	C
C01	.223	.481	.102
C02	.260	.481	.102
C03	.192	.328	.067
C04	.640	1.000	.125
C05	.275	.481	.102
C06	.230	.354	.067
C07	.188	.328	.093

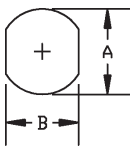

CODE	A	B
G01	.640	.546
G02	.380	.340
G03	.765	.712
G04	.362	.323
G05	.236	.197
G06	.217	.177
G07	.380	.310
G08	1.161	1.000

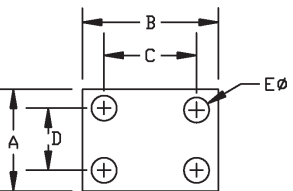

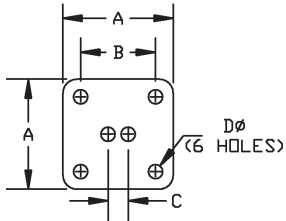

CODE	A	B	C	D	E
E01	.375	.500	.340	.222	.093



CODE	A	B	C	D
H01	.687	.500	.125	.045

CONNECTOR IDENTIFIER

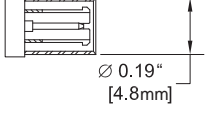
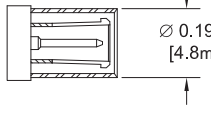
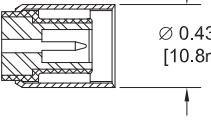
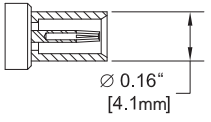
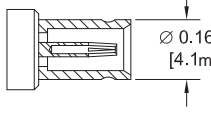
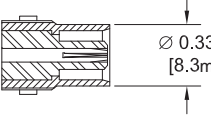
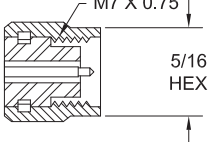
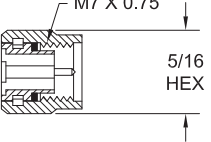
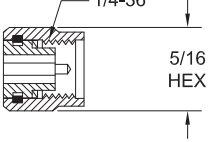
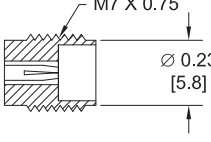
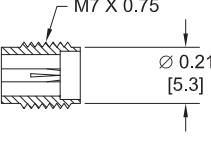
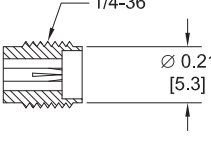
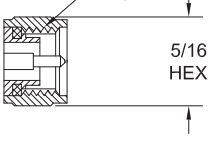
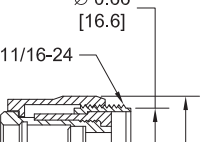
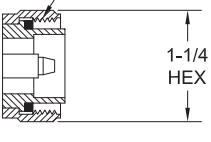
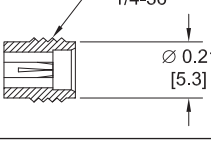
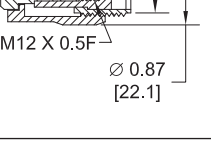
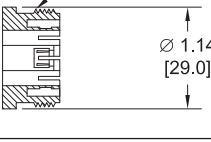
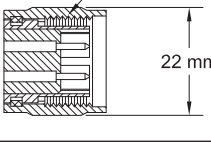
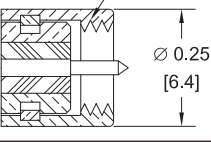
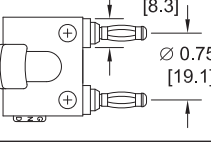
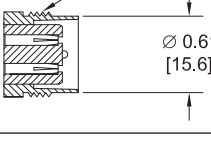
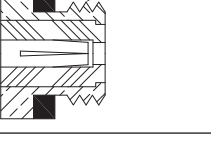
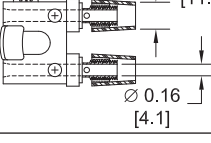
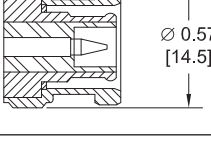
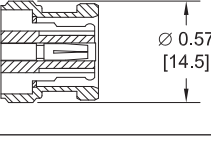
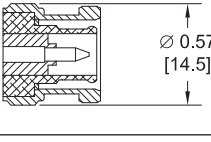
SPECIFICATIONS SHOWN ARE INTENDED FOR IDENTIFICATION PURPOSES ONLY

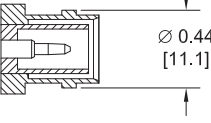
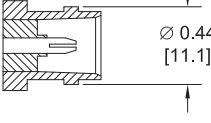









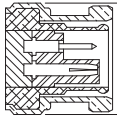
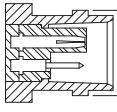
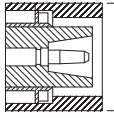
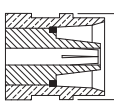
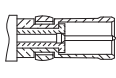
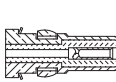
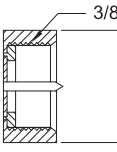
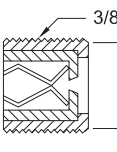
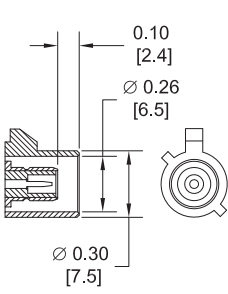
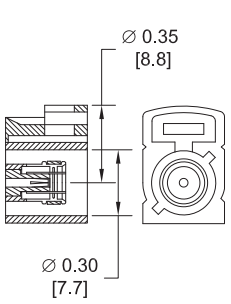







1.0/2.3 SLIDE ON	PLUG		1.0/2.3 SNAP ON	PLUG		1.6/5.6	PLUG	
	JACK			JACK			JACK	
1.85 mm**	MALE		2.4 mm**	MALE		2.92 mm*	MALE	
	FEMALE			FEMALE			FEMALE	
3.5 mm*	MALE		7 mm	MALE		7/16	PLUG	
	FEMALE			FEMALE			JACK	
3/4-20 TWINAX	MALE		10 - 32	MALE		BANANA	PLUG	
	FEMALE			FEMALE			JACK	
BNC	MALE		REVERSE POLARITY BNC	MALE		75 OHM BNC	MALE	
	FEMALE			FEMALE			FEMALE	

*SMA, 2.92mm, & 3.5mm CONNECTORS WILL MATE MECHANICALLY & ELECTRICALLY TO EACH OTHER.

**1.85mm & 2.4mm CONNECTORS WILL MATE MECHANICALLY & ELECTRICALLY TO EACH OTHER.

CONNECTOR IDENTIFIER

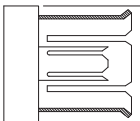
SPECIFICATIONS SHOWN ARE INTENDED FOR IDENTIFICATION PURPOSES ONLY

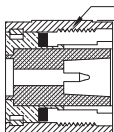
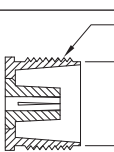
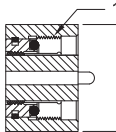
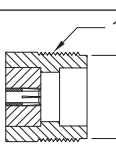
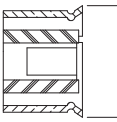
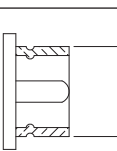
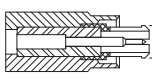
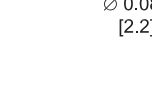
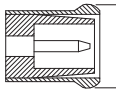
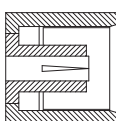
BNC TWINAX	PLUG	 $\varnothing 0.57"$ [14.5mm]			
	JACK	 $\varnothing 0.44"$ [11.1mm]			
C	MALE	 $\varnothing 0.75"$ [19.1mm]			
	FEMALE	 $\varnothing 0.60"$ [15.2mm]			
D SUBMINIATURE	PLUG	 $\varnothing 0.19"$ [4.8mm]			
	RECEPTACLE	 $\varnothing 0.15"$ [3.9mm]			
F	MALE	 3/8-32 7/16 HEX			
	FEMALE	 3/8-32 $\varnothing 0.34$ [8.5]			
FAKRA	PLUG	 0.10 [2.4] $\varnothing 0.26$ [6.5] $\varnothing 0.30$ [7.5]			
	JACK	 $\varnothing 0.35$ [8.8] $\varnothing 0.30$ [7.7]			
FAKRA	COMPLETE KEY CODE INFO				
	CODE	JACK	PLUG	COLOR	APPLICATION
	A			BLACK	RADIO WITH PHANTOM SUPPLY
	B			WHITE	RADIO WITHOUT PHANTOM SUPPLY
	C			BLUE	GPS: TELEMATICS OR NAVIGATION
D			BORDEAUX	GSM: CELLULAR PHONE	
CODE	JACK	PLUG	COLOR	APPLICATION	
H			VIOLET	GPS: TELEMATICS AND NAVIGATION	
I			BEIGE	BLUETOOTH	
K			CURRY	RADIO WITH I.F. OUTPUT (ANTENNA DIVERSITY)	
Z			WATER BLUE	NEUTRAL CODING	
GR874	 $\varnothing 0.81$ [20.6]				
	 $\varnothing 0.08$ [2.0]				
HN	MALE	 3/4-20 $\varnothing 0.90$ [22.9]			
	FEMALE	 3/4-20 $\varnothing 0.67$ [17.1]			
LC	MALE	 1-1/4-18 1-1/2 HEX			
	FEMALE	 1-1/4-18 $\varnothing 1.17$ [29.6]			
UMCX	PLUG	 $\varnothing 0.10$ [2.5]			
	JACK	 $\varnothing 0.08$ [2.0]			
MC-CARD	 $\varnothing 0.087$ [2.2]				
	 $\varnothing 0.087$ [2.2]				
MCX	PLUG	 $\varnothing 0.15$ [3.7]			
	JACK	 $\varnothing 0.20$ [5.0]			

CONNECTOR IDENTIFIER

SPECIFICATIONS SHOWN ARE INTENDED FOR IDENTIFICATION PURPOSES ONLY

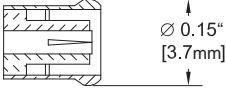
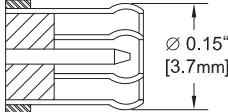
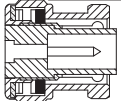
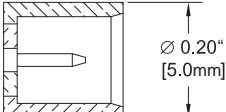
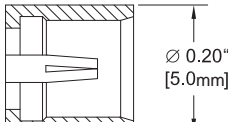
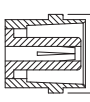
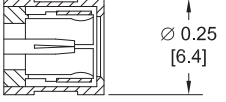
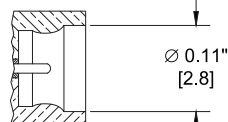
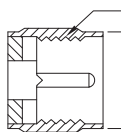
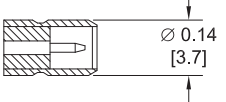
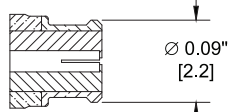
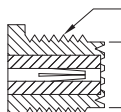
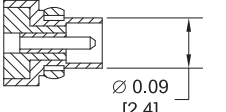
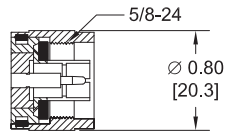
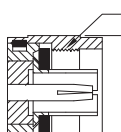
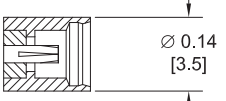
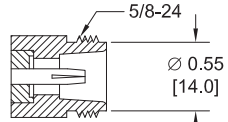
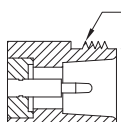
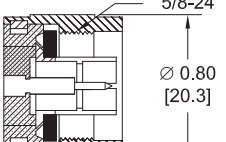
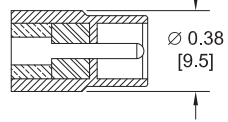
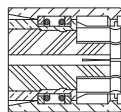
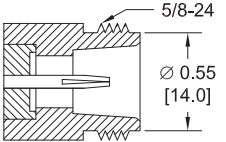
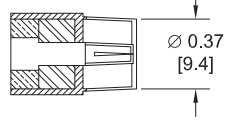
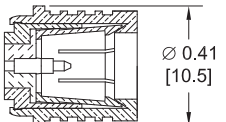
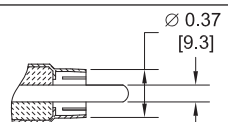
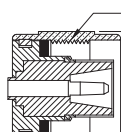
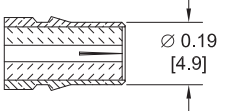
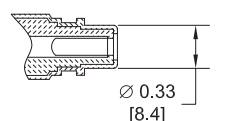
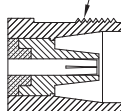
REVERSE POLARITY MCX	PLUG	 Ø 0.15" [3.7mm]	75 OHM MCX	PLUG	 Ø 0.15" [3.7mm]	MHV	MALE	 Ø 0.57" [14.5mm]
	JACK	 Ø 0.20" [5.0mm]		JACK	 Ø 0.20" [5.0mm]		FEMALE	 Ø 0.44" [11.1mm]
MINI 75 OHM SMB	PLUG	 Ø 0.25 [6.4]	MINI SMP	MALE	 Ø 0.11" [2.8]	MINI-UHF	MALE	 3/8-24 Ø 0.45 [11.5]
	JACK	 Ø 0.14 [3.7]		FEMALE	 Ø 0.09" [2.2]		FEMALE	 3/8-24 Ø 0.31 [7.8]
MMCX	PLUG	 Ø 0.09 [2.4]	N	MALE	 5/8-24 Ø 0.80 [20.3]	REVERSE POLARITY N	MALE	 5/8-24 Ø 0.80 [20.3]
	JACK	 Ø 0.14 [3.5]		FEMALE	 5/8-24 Ø 0.55 [14.0]		FEMALE	 5/8-24 Ø 0.55 [14.0]
75 OHM N	MALE	 5/8-24 Ø 0.80 [20.3]	PAL	PLUG	 Ø 0.38 [9.5]	POSITIVE SNAP	 Ø 0.39 [9.9]	
	FEMALE	 5/8-24 Ø 0.55 [14.0]		JACK	 Ø 0.37 [9.4]			
OMA	MALE	 Ø 0.41 [10.5]	RCA	PLUG	 Ø 0.37 [9.3] Ø 0.13 [3.2]	SC	MALE	 11/16-24 Ø 0.80 [20.3]
	FEMALE	 Ø 0.19 [4.9]		JACK	 Ø 0.33 [8.4]		FEMALE	 11/16-24 Ø 0.63 [15.9]

CONNECTOR IDENTIFIER

SPECIFICATIONS SHOWN ARE INTENDED FOR IDENTIFICATION PURPOSES ONLY

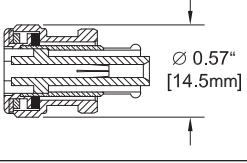
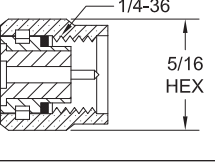
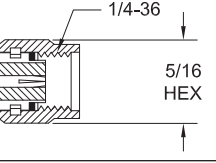
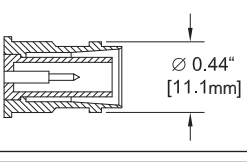
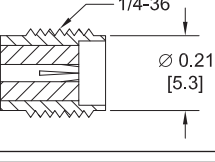
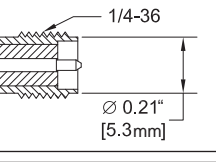
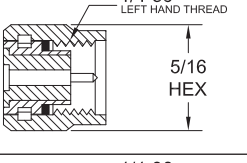
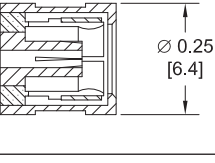
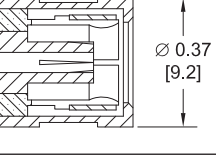
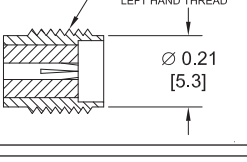
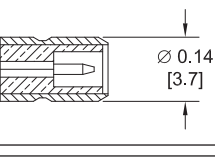
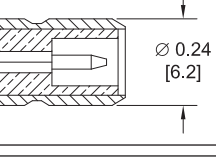
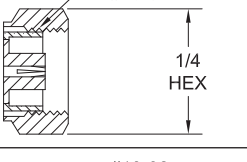
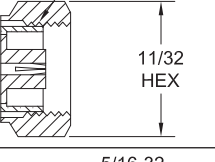
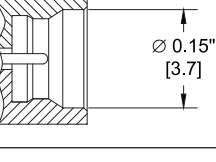
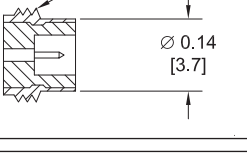
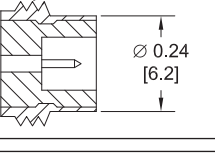
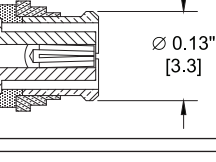
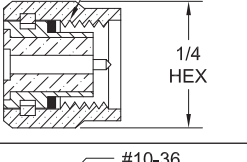
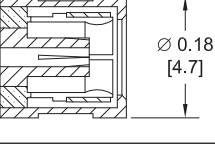
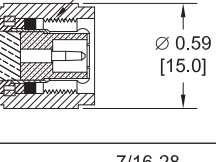
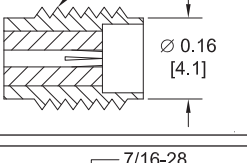
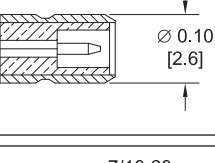
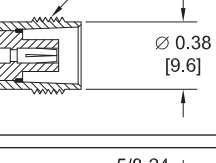
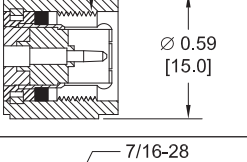
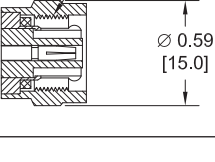
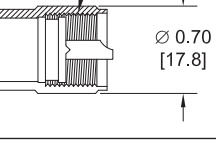
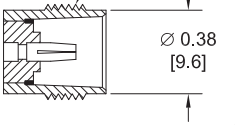
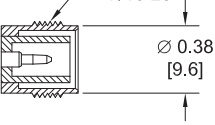
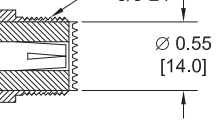
SHV	PLUG	 Ø 0.57" [14.5mm]	SMA*	MALE	 1/4-36 5/16 HEX	REVERSE POLARITY SMA	MALE	 1/4-36 5/16 HEX
	JACK	 Ø 0.44" [11.1mm]		FEMALE	 1/4-36 Ø 0.21 [5.3]		FEMALE	 1/4-36 Ø 0.21" [5.3mm]
SMA REVERSE THREAD	MALE	 1/4-36 LEFT HAND THREAD 5/16 HEX	SMB	PLUG	 Ø 0.25 [6.4]	75 OHM SMB	PLUG	 Ø 0.37 [9.2]
	FEMALE	 1/4-36 LEFT HAND THREAD Ø 0.21 [5.3]		JACK	 Ø 0.14 [3.7]		JACK	 Ø 0.24 [6.2]
SMC	PLUG	 #10-32 1/4 HEX	75 OHM SMC	PLUG	 5/16-32 11/32 HEX	SMP	MALE	 Ø 0.15" [3.7]
	JACK	 #10-32 Ø 0.14 [3.7]		JACK	 5/16-32 Ø 0.24 [6.2]		FEMALE	 Ø 0.13" [3.3]
SSMA	MALE	 #10-36 1/4 HEX	SSMB	PLUG	 Ø 0.18 [4.7]	TNC	MALE	 7/16-28 Ø 0.59 [15.0]
	FEMALE	 #10-36 Ø 0.16 [4.1]		JACK	 Ø 0.10 [2.6]		FEMALE	 7/16-28 Ø 0.38 [9.6]
75 OHM TNC	MALE	 7/16-28 Ø 0.59 [15.0]	REVERSE POLARITY TNC	MALE	 7/16-28 Ø 0.59 [15.0]	UHF	MALE	 5/8-24 Ø 0.70 [17.8]
	FEMALE	 7/16-28 Ø 0.38 [9.6]		FEMALE	 7/16-28 Ø 0.38 [9.6]		FEMALE	 5/8-24 Ø 0.55 [14.0]

*SMA, 2.92mm & 3.5mm CONNECTORS WILL MATE MECHANICALLY & ELECTRICALLY TO EACH OTHER.

CONNECTOR FREQUENCY RANGE CHART

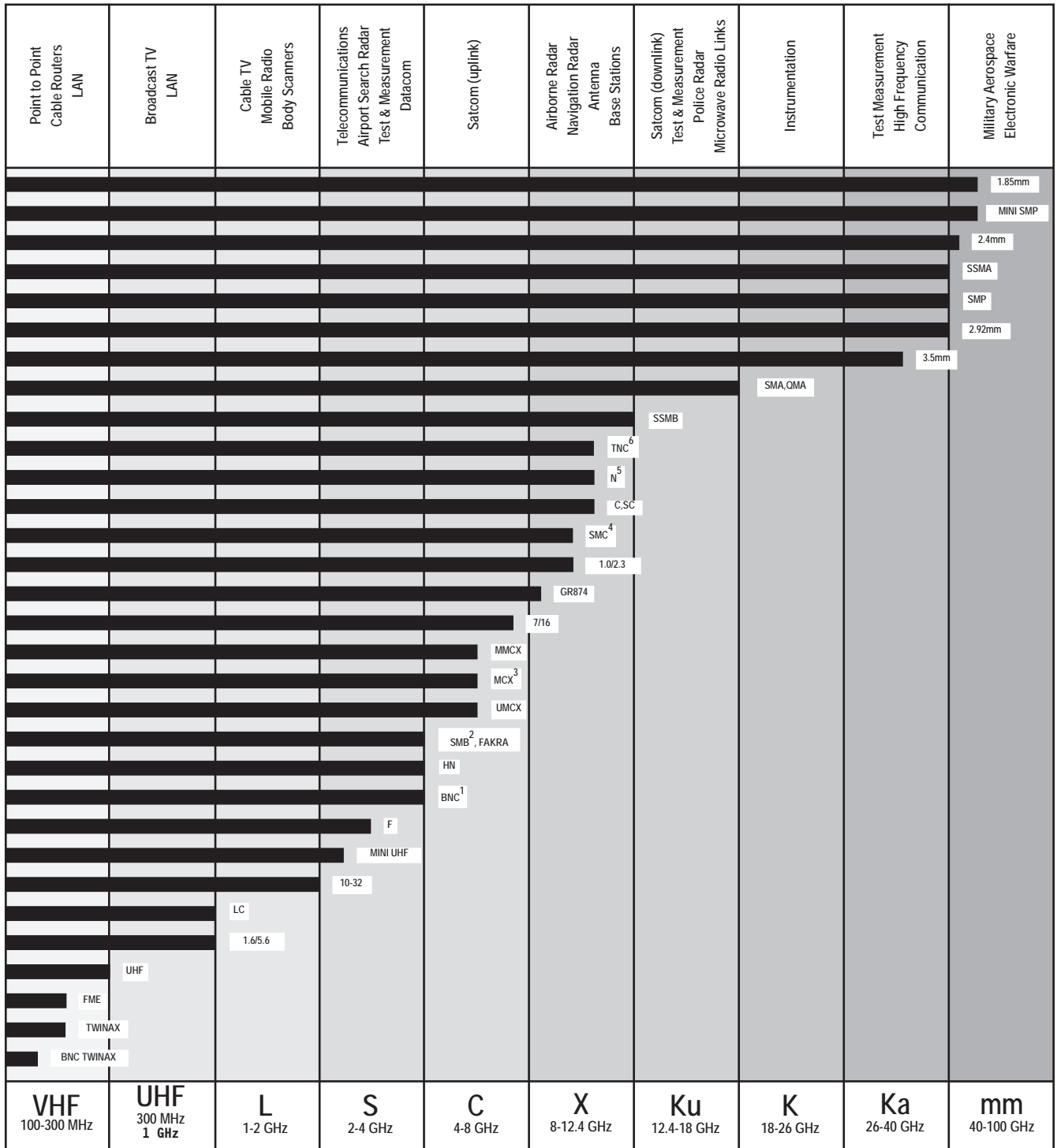

Notes:

- 1: BNC-75 Ohm connectors operate up to 1 GHz
- 2: SMB-75 Ohm & Mini SMB-75 Ohm connectors operate up to 4 GHz
- 3: MCX-75 Ohm connectors operate up to 6 GHz
- 4: SMC-75 Ohm connectors operate up to 10 GHz
- 5: N-75 Ohm connectors operate up to 1.5 GHz
- 6: TNC-75 Ohm connectors operate up to 1 GHz



RF Solutions from RF Engineers

4TECT

ООО «4TECT»

Телефон: +7 (499) 685-4444

info@4test.ru

www.4test.ru